

User Manual

for Leapfrog Geo version 4.5

© 2019 Seequent Limited (“**Seequent**”). All rights reserved. Unauthorised use, reproduction, or disclosure is prohibited. Seequent assumes no responsibility for errors or omissions in this document. LEAPFROG, SEEQUENT and  are trade marks owned by Seequent. All other product and company names are trade marks or registered trade marks of their respective holders. Use of these trade marks in this document does not imply any ownership of these trade marks or any affiliation or endorsement by the holders of these trade marks.

Contents

Getting Started	1
Licensing Leapfrog Geo	1
Dongle Licences	1
Code Licences	2
Signing in to My Leapfrog	3
Graphics and Drivers	3
Switching to High-Performance Graphics	4
Running the Graphics Test	5
The Leapfrog Geo Projects Tab	7
Managing Leapfrog Geo Projects	7
Saving Projects	8
Saving Zipped Copies of Projects	8
Saving Backup Copies of Projects	8
Compacting Projects	8
Upgrading Projects	9
Converting Leapfrog Hydro Projects	9
What is Implicit Modelling?	10
What are the Advantages of Implicit Modelling?	10
Implicit Modelling Makes Assumptions Explicit	11
Best Practices	11
An Overview of Leapfrog Geo	13
Keyboard Shortcuts in the Main Window	14
The Project Tree	15
Organising Objects in the Project Tree	18
Subfolders	18
Copying Objects	19
Renaming Objects	19
Finding Objects	20
Deleting Objects	20
Sharing Objects	21
Restricted Objects	21
Object Properties	22
Comments	22
Processing Tasks	23
Prioritising Tasks	24

Correcting Errors	24
Project Tree Keyboard Shortcuts	25
The 3D Scene	26
Locating an Object from the Scene	29
Clicking in the Scene	30
Clicking in the Shape List	31
Slicing Through the Data	32
Slicer Properties	33
Object Slice Mode	34
Slicer Shortcuts	34
Measuring in the Scene	35
Determining a Location	36
The Moving Plane	37
The Ruler	38
Working With Split Views	40
Visualising Data	44
Colour Options	46
Single Colour Display	46
Colourmaps	47
Category Colourmaps	48
Numeric Data Colourmaps	48
Continuous Colourmaps	50
Discrete Colourmaps	52
Opacity	55
Property Buttons	56
Legends	56
Slice Mode	56
Filtering Data Using Queries	57
Filtering Data Using Values and Categories	57
Drawing in the Scene	58
The Drawing Toolbar	59
Drawing Hotkeys	60
Drawing 3D Lines	61
Drawing 2D Lines	63
Polyline Properties	64
Tangents and Ribbons	64
Drawing Points	65

Editing Normals	66
Organising Your Workspace	68
Detaching Tabs	68
Detaching and Minimising the Project Tree	69
Organising the Scene View Tab	69
Interpolant Functions	71
The Spheroidal Interpolant Function	71
Total Sill	72
Nugget	73
Nugget to Total Sill Ratio	73
Base Range	73
Alpha	75
Drift	76
Accuracy	78
The Linear Interpolant Function	78
Total Sill and Base Range	80
Nugget	80
Drift	80
Accuracy	81
Central Integration	82
Enabling Central	82
Setting Up the Connection	83
Connecting to Central	84
Viewing a Project's History	85
Locking Branches	86
Project Included	87
Project Stages	87
Annotations and Attachments	87
Sharing Projects	88
Downloading a Local Copy of a Project	89
Publishing to Central	89
Unfinished Publish Events	90
Selecting Objects	90
Setting the Project Workflow Stage	91
Including the Project	91
Adding Revision Information	91
Preparing the Package	91

Uploading the Package	91
New Central Projects	92
Creating a New Central Project	92
Adding a Project to Central	93
Troubleshooting Connectivity Issues	93
Settings	94
Display and Navigation Settings	94
3D Acceleration Mode	94
Font Size	95
Z Axis Scale	95
Rotation Settings	96
Camera Settings	96
Overlay Settings	97
Screen Grid Settings	97
Axis Lines Settings	97
Other Overlay Settings	97
Colour Scheme	97
Lighting Settings	98
Processing Settings	99
User Interface Settings	99
Show Tree Lines	99
Show Save Scene Button	99
Upload to View	100
Tab Position	100
Central Settings	100
Network Settings	101
Help Settings	102
Reporting a Problem	102
Getting Support	102
Checking Connectivity with Leapfrog Start	102
Supplying Your Licence Details	103
Data Types	104
Working with Data Tables	105
Identifying Errors in Data Tables	106
Exporting Data Errors	107
Correcting Data Errors in Leapfrog Geo	108
Replacing Values in a Column	109

Common Errors and How to Fix Them	110
Duplicate Points Error (Points Tables)	111
Duplicate Hole ID Error	111
Hole ID Not in Collar Table Error	112
Collar Max Depth Error	112
Invalid Max Depth Error	113
From Depth Exceeds To Depth Error	113
Overlapping Segments Error	114
No Samples for Collars Warning	114
No Surveys for Collar Warning	115
Wedges Found Warning	115
Handling Special Values	115
Boundaries	117
The Clipping Boundary	117
Object Extents	120
Extending a Surface	121
Query Filters	123
Creating a New Query Filter	124
Leapfrog Geo Query Syntax	125
Building a Query	126
Advanced Queries	127
Defining a Topography	127
Topography From Elevation Grid	128
Topography From Surfaces, Points or GIS Vector Data	128
Fixed Elevation Topography	129
Adding Height Data to the Topography	129
Changing Topography Settings	130
Changing the Size of the Topography	130
Topography Resolution	131
Applying a Trend to the Topography	131
Topography Display Options	131
Projecting Collars onto the Topography	132
GIS Data, Maps and Images	133
Displaying GIS Data	133
Custom Topography Views	133
Importing Vector Data	135
Importing a MapInfo Batch File	136

Importing Data from an ESRI Geodatabase	137
Reloading GIS Data	138
Reloading Points, Lines and Polygons	138
Reloading an ESRI Database	138
2D Grids	139
Importing a Map or Image	139
Manual Georeferencing	141
Automatic Georeferencing	142
Exporting a Georeferenced Image	142
Setting Elevation for GIS Objects and Images	142
Creating a New GIS Line	143
Drawing a New GIS Line	144
Creating a New GIS Line from Intersecting Meshes	144
Exporting GIS Data	145
Drillhole Data	146
Displaying Drillholes	147
Displaying Drillholes as Lines or Cylinders	148
Hiding Lithologies	150
Displaying a Legend	150
Changing Colourmaps	151
Viewing Multiple Interval Tables	151
Selecting from Multiple Columns	151
Displaying Interval Data in the Scene	152
Displaying Drillhole Graphs	153
Viewing Drillhole Data Table Statistics	155
Importing Drillhole Data	155
Expected Drillhole Data Tables and Columns	156
The Collar Table	156
The Survey Table	157
The Screens Table	157
Interval Tables	157
Selecting Files	158
Working Through the Data	159
Selecting the ODBC Data Source	162
Selecting Tables	162
Connecting to an acquire Database	164
Smart Refresh	165

Saving a Selection	165
Appending Drillholes	165
Importing Interval Tables	166
Importing Columns	166
Importing Screens	167
Importing Point Values Down Drillholes	167
Importing LAS Points Down Drillholes	167
LAS File Mapping	168
LAS File Inconsistencies	168
Importing Downhole Structural Data	169
Drillhole Desurveying Options	169
The Spherical Arc Approximation Algorithm	170
The Balanced Tangent Algorithm	171
The Raw Tangent Algorithm	171
Processing Drillhole Data	172
Category Composites	173
Converting Ignored Segments	174
Filtering Short Segments	176
Viewing Category Composite Statistics	177
Economic Composites	178
Creating an Economic Composite	179
Selecting Values	179
Handling Missing Intervals and High Grades	180
Selecting a Dilution Rule	180
Setting the Cut-Off Grade	180
Two-Pass Compositing	180
Using True Thickness	181
The Compositing Process and Parameters	181
Viewing Compositing Results	186
Majority Composites	188
Viewing Majority Composite Statistics	190
Numeric Composites	191
Creating a Numeric Composite	191
Selecting the Compositing Region	192
Compositing in the Entire Drillhole	192
Compositing in a Subset of Codes	192
Compositing in Intervals	193

Compositing Parameters	193
Discard	194
Add to Previous Interval	194
Distribute Equally	194
Viewing Numeric Composite Statistics	195
Compositing Comparison	196
Compositing Interval Lengths	197
Grouping Lithologies	198
Automatic Lithology Groups	201
Splitting Lithologies	202
Interval Selection	205
Overlaid Lithology Column	208
Category Column from Numeric Data	209
Back-Flagging Drillhole Data	210
Comparing Modelled Values to Drilling Lithologies	211
Comparing Drilling Lithologies to Modelled Values	214
Refining the Geological Model to Improve Correlation Statistics	215
Merged Drillhole Data Tables	215
Core Photo Links	216
The ALS Core Photo Interface	217
Setting Up the ALS Interface	217
Using the ALS Interface	219
Removing the ALS Link	219
The Coreshed Core Photo Interface	219
Setting Up the Coreshed Interface	220
Using the Coreshed Interface	220
Removing the Coreshed Link	221
Reloading Drillhole Data	221
Exporting Drillhole Data	221
Exporting All Drillhole Data	222
Exporting a Single Drillhole Data Table	223
Points Data	224
Importing Points Data	224
Selecting the ODBC Data Source	225
Reloading Points Data	225
Appending Points Data	225
Importing a Column	225

Importing ASEG_DFN Points	226
Setting Elevation for Points	226
Evaluating Points Data	226
Displaying Points	227
Viewing Points Table Statistics	228
Exporting Points Data	229
Exporting Intrusion Values	229
Exporting Interval Midpoints	229
Extracting Points from Drillhole Data	230
Extracting Contact Points from Drillhole Data	230
Extracting Intrusion Values from Drillhole Data	232
Intrusion Point Generation Parameters	233
Extracting Interval Midpoints from Drillhole Data	234
Creating Guide Points	234
Grids of Points	235
Creating a Grid of Points	235
Evaluating a Grid of Points	237
Statistics for a Grid of Points	237
Exporting a Grid of Points	237
Categorising Points	238
Structural Data	241
Creating New Planar Structural Data Tables	241
Importing Planar Structural Data	243
Selecting the ODBC Data Source	244
Importing Lineations	244
Displaying Structural Data	245
Viewing Statistics on Structural Data	248
Bingham Analysis	248
Fisher Statistics	249
Assigning Structural Data to Categories	249
Editing the Orientation of Planar Structural Data	251
Declustering Planar Structural Data	251
Setting Elevation for Structural Data	253
Estimating Planar Structural Data	253
Meshes	253
Cleaning Up a Mesh	254
Importing a Mesh	256

Meshes with Textures	256
Textured OBJ Meshes	256
Textured Vulcan 8 Meshes	257
Reloading a Mesh	257
Displaying Surfaces	257
Draping an Image on a Mesh	258
Importing Meshes from Central	258
Importing Central Meshes	259
Updating Out-of-Date Meshes	260
Exporting Meshes	260
Exporting a Single Mesh	261
Exporting Multiple Meshes from the Meshes Folder	263
Exporting Multiple Meshes from Models	264
Modifying Surfaces	266
Surface Resolution in Leapfrog Geo	266
Adding Data to Surfaces	267
Honouring Surface Contacts	268
Global Trends	271
Structural Trends	273
Creating a Structural Trend	273
Displaying a Structural Trend	275
Applying a Structural Trend	276
Editing Surfaces with Polylines	277
Editing Surfaces with Structural Data	279
Non-Editable Meshes	279
Mesh from the Moving Plane	279
Combining Meshes	280
Clipping a Volume	280
Clipping a Mesh	281
Extracting Mesh Parts	281
Interpolated Meshes	282
Creating an Interpolated Mesh	283
Refining an Interpolated Mesh	283
Surface Resolution Settings	284
Snap Settings	284
Other Options	285
Offset Meshes	285

Triangulated Meshes	287
Elevation Grids	288
Importing an Elevation Grid	289
Exporting an Elevation Grid	290
Thickness Grids	290
Polylines	292
Creating Polylines	292
Displaying Polylines	292
Sharing and Unsharing Polylines	293
Importing Polylines	294
Reloading Polylines	295
Exporting Polylines	295
Geochemical Data	296
Sending Data to ioGAS	297
Opening the Data in ioGAS	298
Sending a New Data Column Back to Leapfrog Geo	299
Importing ioGAS Data	300
Importing ioGAS Data as Points	301
Importing ioGAS Data as Intervals	301
Open Mining Format (OMF) Export and Import	301
OMF Export	302
OMF Import	303
Analysing Data	304
Statistics	304
Table of Statistics	305
Scatter Plots	309
Q-Q Plots	311
Box Plots	312
Univariate Graphs	313
Drillhole Correlation Tool	315
Selecting Collars	315
The Correlation Set Window	317
Navigating in the Correlation Set Window	319
Correlation Column Layouts	319
Managing Styles	320
Interpretation Tables	320
Assigning Lithologies	321

Modifying the Interpretation Table	322
Stereonet	325
Creating a Stereonet	325
Displaying the Stereonet in the 3D Scene	326
Plot Options	327
Data Display Options	327
Viewing Stereonet Statistics	331
Selecting Data in the Stereonet	331
Using the Scene Window with the Stereonet	336
Exporting a Stereonet	336
Form Interpolants	337
Creating a Form Interpolant	337
Setting a Trend	338
Adding Isosurfaces	339
The Form Interpolant in the Project Tree	339
Form Interpolant Statistics	340
Planning Drillholes	341
Adding Planned Drillholes	341
Planning Options	345
Drilling Prognoses	345
Exporting Planned Drillholes	346
Export Parameters	346
Export as Interval Table	346
Importing Planned Drillholes	346
Modelling	348
Evaluations	348
Assigning Attributes to Volumes	349
Geological Models	351
Creating a New Geological Model	351
The Base Lithology	351
Surface Resolution	352
Model Extents	352
The Geological Model in the Project Tree	353
Geological Model Display	353
Copying a Geological Model	354
Creating a Static Copy of a Geological Model	354
Geological Model Volumes and Surfaces Export Options	354

Extracting Model Volumes	355
Editing a Geological Model	356
Changing the Query Filter	357
Surface Generation Options	358
Volume Generation Options	359
Surface Resolution for a Geological Model	359
Modifying a Geological Model’s Boundary	360
Creating Extents for a Geological Model	361
Extent From a Polyline	361
Extent From GIS Vector Data	362
Extent From Points	363
Extent From Structural Data	363
Extent From a Surface	365
Extent From Distance to Points	365
Extent From a Distance Function	366
Base From Lithology Contacts	367
Changing an Extent’s Settings	368
Surface Resolution	368
Contact Honouring	369
Applying a Trend	369
Adding Data to an Extent	370
Editing an Extent with a Polyline	370
Editing an Extent with Structural Data	370
Removing an Extent from a Geological Model	371
Model Lithologies	372
Faulted Models	373
The Fault System	374
Fault Interactions	375
Activating the Fault System	376
Copying the Surface Chronology to an Empty Fault Block	376
Faulted Model Display Options	377
Editing Faults	377
Surfacing Options for Faults	377
Boundary Filtering	378
Snapping to Data	378
Changing Fault Inputs	379
Replacing Fault Inputs with a Single Mesh	379

Adding Data to the Fault	380
Snap Settings for Individual Inputs	380
Boundary Filtering Settings for Individual Inputs	380
Applying a Trend to a Fault	380
Contact Surfaces	381
Contact Surfaces in the Surface Chronology	381
Contact Surfaces Types	384
Deposit and Erosion Contact Surfaces	385
Intrusion Contact Surfaces	386
Vein Contact Surfaces	388
Younging Direction	389
Deposits and Erosions	389
Creating Deposits and Erosions	390
Deposits and Erosions From the Base Lithology	390
Deposits and Erosions From Other Lithology Contacts	393
Deposits and Erosions From Other Data	394
Deposits/Erosions in the Project Tree	396
Refining Deposits and Erosions	396
Surfacing Options for Deposits and Erosions	397
Boundary Filtering	397
Snapping to Data	397
Setting the Surface Resolution	398
Applying a Trend to a Deposit/Erosion	398
Intrusions	398
Creating Intrusions	399
Intrusions from Lithology Contacts	399
Intrusions from Other Data	400
Intrusions in the Project Tree	402
Displaying Intrusion Points	402
Refining Intrusions	403
Surfacing Options for Intrusions	403
Boundary Filtering	403
Snapping to Data	404
Surface Resolution	404
Applying a Trend to an Intrusion	405
Clipping Values for Intrusions	406
Interpolation Settings	406

Veins	407
Creating Veins	407
Veins From Lithology Contacts	407
Veins From Other Data	408
Veins in the Project Tree	409
Displaying Veins	410
Refining Veins	410
Surfacing Options for Veins	410
Boundary Filtering	410
Snapping to Data	411
Surface Resolution	411
Vein Thickness	411
Vein Pinch Out	412
The Vein Reference Surface	413
Adding Data to the Reference Surface	414
Using a Planar Reference Surface	415
The Vein Boundary	415
Adding a Polyline to the Vein Boundary	416
Adjusting the Vein Boundary Plane	416
Editing Vein Segments	417
Vein Segment Orientation	417
Vein Systems	417
Creating a Vein System	419
Adding Veins to the Vein System	419
Editing the Veins	419
Changing Vein System Lithology Settings	419
Setting Vein Interactions	420
Stratigraphic Sequences	422
Creating a Stratigraphic Sequence	423
Boundary Filtering	425
Snapping to Data	425
Surface Stiffness	426
Editing the Stratigraphic Sequence	426
Correcting Pinch-Out Errors	426
Surfacing Options	427
Applying a Trend	427
Editing Individual Surfaces	427

Contact Honouring and Boundary Filtering for Individual Surfaces	428
Adding Data to Individual Surfaces	428
Editing Surface Contacts	428
Offset Surfaces	428
Creating an Offset Surface	430
The Offset Surface in the Project Tree	431
Refining an Offset Surface	431
Changing Surfacing Options for an Offset Surface	431
Boundary Filtering	432
Snapping to Data	432
Surface Resolution	433
Smoothing	433
Changing Offset Limits	433
Changing to a Constant Offset	433
Changing to an Offset to Points	434
Changing the Reference Mesh	434
Editing the Reference Mesh	434
Structural Surfaces	434
Creating a Structural Surface	435
The Structural Surface in the Project Tree	436
Refining a Structural Surface	436
Surfacing Options for a Structural Surface	437
Setting the Surface Resolution	437
Boundary Filtering	437
Snapping to Input Data	437
Non-Contact Structural Inputs Settings	438
Applying a Trend to a Structural Surface	438
Value Clipping	438
The Surface Chronology	439
Refined Models	440
Editing the Sub-Model	442
Numeric Models	444
Importing a Variogram Model	445
Copying a Numeric Model	445
Creating a Static Copy of a Numeric Model	445
Exporting Numeric Model Volumes and Surfaces	446
Exporting Numeric Model Midpoints	446

RBF Interpolants	446
Creating an RBF Interpolant	447
Values Used	447
Applying a Query Filter	448
Applying a Surface Filter	448
The Interpolant Boundary	448
Compositing Options	448
General Interpolant Properties	449
The RBF Interpolant in the Project Tree	449
Interpolant Display	450
RBF Interpolant Statistics	450
Modifying an RBF Interpolant's Boundary with Lateral Extents	450
Creating Lateral Extents	451
Extent from a Polyline	451
Extent from GIS Vector Data	452
Extent from Points	453
Extent from Structural Data	453
Extent from a Surface	454
Extent from Distance to Points	454
Extent from a Distance Function	455
Changing a Lateral Extent's Settings	456
Surface Resolution	456
Contact Honouring	456
Applying a Trend	457
Adding Data to an Extent	458
Editing an Extent with a Polyline	458
Editing an Extent with Structural Data	458
Removing an Extent from an Interpolant	458
Changing the Settings for an RBF Interpolant	459
Adjusting the Values Used	459
Adding a Contour Polyline	460
Adding Points	461
Compositing Parameters for an RBF Interpolant	461
Adjusting the Interpolant Boundary	462
Clipping and Transforming Values for an RBF Interpolant	463
Changing the Trend for an RBF Interpolant	464
Using a Global Trend	464

Using a Structural Trend	465
Adjusting Interpolation Parameters	467
Output Settings for an RBF Interpolant	468
Multi-Domained RBF Interpolants	468
Creating a Multi-Domained RBF Interpolant	469
Compositing and Filtering the Values Used	470
Selecting Domains	471
Clipping and Transforming Values	471
Setting the Trend	471
Interpolation Parameters	471
Output Options	471
The Multi-Domained RBF Interpolant in the Project Tree	473
Interpolant and Sub-Interpolant Display	473
Sub-Interpolant Statistics	474
Indicator RBF Interpolants	474
Creating an Indicator RBF Interpolant	475
Selecting the Values Used	475
Setting the Cut Off	475
Applying a Query Filter	476
Applying a Surface Filter	476
The Interpolant Boundary	476
Compositing Options	476
General Interpolant Properties	477
The Indicator RBF Interpolant in the Project Tree	477
Indicator RBF Interpolant Display	478
Indicator RBF Interpolant Statistics	479
Editing an Indicator RBF Interpolant	479
Adjusting the Values Used	480
Adding a Contour Polyline	480
Adding Points	482
Compositing Parameters for an Indicator RBF Interpolant	483
Adjusting the Interpolant Boundary	484
The Cut-Off Value	485
Changing the Trend for an Indicator RBF Interpolant	485
Adjusting Interpolation Parameters	486
Indicator RBF Interpolant Surfacing and Volume Options	486
Distance Functions	487

Creating a Distance Function	488
Setting the Boundary	490
Setting a Trend	490
Adding Buffers	490
The New Distance Function in the Project Tree	491
Combined Models	492
Creating a Combined Model	492
The Combined Model in the Project Tree	493
Editing a Combined Model	494
Displaying a Combined Model	494
Creating a Static Copy of a Combined Model	494
Combined Model Export	494
Flow Models	495
MODFLOW Models	495
Creating a MODFLOW Model	496
Horizontal Grid Spacing	497
Vertical Grid Layering	498
Editing a MODFLOW Model	500
Importing a MODFLOW Model	502
MODFLOW Evaluations	503
Assigning an Evaluation for Export	503
Combined Evaluations	503
MODFLOW Hydrological Properties	504
Setting Hydrological Properties	505
Zone Numbers	507
MODFLOW Model Display	507
Grid Display Options	508
Viewing Block Information	509
Head Values and MT3D Concentrations	509
Generating a Head Value Mesh	510
MODFLOW Model Export	510
As a MODFLOW File	511
For Groundwater Vistas	511
As a Groundwater Vistas Update	511
FEFLOW Models	511
FEFLOW Model Display	512
Displaying a 3D Model	514

Displaying a 2D Model	515
Viewing Block Information	516
Importing a FEFLOW Grid	516
Creating a 2D FEFLOW Model	517
Boundary Options	518
Element Size	519
Adding Features to the Grid	519
Creating a 3D FEFLOW Model	521
FEFLOW Evaluations	523
Assigning an Evaluation for Export	523
Combined Evaluations	524
FEFLOW Material Types	524
FEFLOW Model Export	526
Block Models	527
Importing a Block Model	527
Importing an Isatis Block Model	527
Importing a Block Model in CSV Format	528
Creating a Block Model	529
Displaying a Block Model	530
Viewing Block Model Statistics	531
Table of Statistics	531
Exporting Block Models	533
Exporting Block Models in CSV Format	533
Selecting From Evaluated Items	534
Setting Row Filtering Options	534
Setting Numeric Precision	534
Setting Status Code Text Sequences	534
Selecting the Character Set	535
Exporting Block Models in Isatis Format	535
Selecting From Evaluated Items	535
Setting Status Code Text Sequences	535
Selecting the Character Set	536
Exporting Block Models in Datamine Format	536
Selecting From Evaluated Items	536
Setting Row Filtering Options	536
Setting Status Code Text Sequences	536
Selecting the Character Set	537

Renaming Items	537
Exporting Block Models in Surpac Format	537
Selecting From Evaluated Items	537
Setting Row Filtering Options	538
Setting Numeric Precision	538
Setting Status Code Text Sequences	538
Selecting the Character Set	538
Sub-Blocked Models	539
Creating a Sub-Blocked Model	539
Model Extents and Rotation	539
The Grid Pattern	540
Triggers and Evaluations	540
Sub-Blocked Model Statistics	540
Sub-Blocked Model Export	541
Exporting Sub-Blocked Models in CSV Format	541
Selecting From Evaluated Items	542
Setting Row Filtering Options	542
Setting Numeric Precision	542
Setting Status Code Text Sequences	542
Selecting the Character Set	543
Exporting Sub-Blocked Models in Datamine Format	543
Selecting From Evaluated Items	543
Setting Row Filtering Options	543
Setting Status Code Text Sequences	544
Selecting the Character Set	544
Renaming Items	544
UBC Grids	545
Importing a UBC Grid	545
Evaluating UBC Grids	545
Mapping Category Evaluations	545
Exporting a UBC Grid	546
Leapfrog Edge	547
Best Practices	547
Expertise is a Prerequisite	547
The Geology is Fundamental	547
Analyse the Data First	547
Domaining	548

Variogram Hypothesis and Experimentation, Analysis	548
Estimation Functions	548
Block Modelling	548
Data Analysis Tools	549
The Ellipsoid Widget	549
Domained Estimations	552
Creating a Domained Estimation	553
Defining the Domain	554
Selecting Values	555
Setting Compositing Options	555
Boundary Validation	556
The Domained Estimation in the Project Tree	558
Viewing Statistics	559
Copying a Domained Estimation	560
Variogram Models	560
The Variogram Model Window	562
Variogram Model Controls	563
Linear, Spherical and Spheroidal Model Options	564
Normalised Y Axis	564
Direction	565
Experimental Controls	565
Experimental Variogram Parameters	568
Capping	568
Defining the Search Space	568
Radial Plot Parameters	571
Orienting Custom Variograms	572
Changing Variogram Display	572
The Downhole Variogram	573
Axis Aligned Variograms	575
Custom Variograms	577
Variable Orientation	578
Visualisation Options for Variable Orientations	580
Creating Variable Orientations	581
Selecting the Inputs	581
Setting the Global Plunge	582
Setting Visualisation Options	583
The Variable Orientation in the Project Tree	584

Applying a Variable Orientation	584
Exporting Rotations	586
Sample Geometries	588
Creating a New Declustering Object	589
General Settings	591
Outputs	592
The Declustering Object in the Project Tree	592
Applying a Declustering Object	593
Estimators	593
Inverse Distance Estimators	593
Nearest Neighbour Estimators	596
Kriging Estimators	597
Kriging Attributes	600
RBF Estimators	602
Visualising Sample Geometries and Estimators	604
Combined Estimators	605
Creating a Combined Estimation	606
Adding Estimators to a Combined Estimation	607
Evaluating a Combined Estimation	609
Viewing Statistics	616
Copying a Combined Estimation	616
Calculations and Filters on Block Models	616
The Calculations Window	617
Creating a New Calculation or Filter	619
Variables	619
Numeric Calculations	620
Category Calculations	620
Filters	620
Understanding Errors Reported in the Errors Pane	620
Building Calculations and Filters	622
Examples of Variables	623
Example of a Numeric Calculation	623
Example of a Filter	624
Example of a Category Calculation	624
Null Values	627
Catalogue of Metadata, Syntax and Functions	629
Existing Items	630

Metadata	630
Evaluations	631
Variables, Calculations and Filters	632
Syntax and Functions	633
Statements	634
Basic Operators	635
Complex Comparisons	639
Invalid Values	640
Mathematics	642
Limits and rounding	644
Text	646
Unit conversion	650
Block Estimate Interrogation	653
Grade Tonnage Graphs	657
Swath Plots	662
Resource Reports	667
Presentation	671
Uploading to View	671
Signing in to View	674
Uploading to View	675
Uploading the 3D View	675
Uploading Saved Scenes	676
Troubleshooting Connectivity Issues	676
Sections	677
Evaluating on Sections	677
Exporting Sections	677
Exporting Section Layouts	678
Creating Cross Sections	679
Importing Cross Sections	681
Fence Sections	682
Serial Sections	683
Setting the Base Section	683
Setting the Offset Sections	684
The Serial Section in the Project Tree	685
Displaying a Serial Section	685
Exporting a Serial Section	686
Section Layouts	687

Setting Up the Section	688
Creating New Section Layouts	689
Copying Section Layouts	690
Working With the Section Layout Editor	691
Changing Page Properties	692
Changing the Basic Section Properties	693
Organising Objects on the Section	697
Adding and Styling Models	698
Adding Styling Drillholes and Planned Drillholes	704
Adding and Styling Surfaces	708
Adding and Styling Lines	709
Setting Up the Legend	710
Adding and Organising Annotations	714
Displaying a Title	715
Displaying a Title Block	716
Displaying a Scale Bar and Location Information	717
Text Boxes	719
Images	720
Rendered Images	721
Background Rendering	723
Saved Scenes	723
Saving Scenes	724
Exporting Scenes	724
Exporting Scenes for Leapfrog Aspect	725
Linking to Scene Files	726
Movies	726
Contour Lines	728
Creating Contour Lines	728
Exporting GIS Contours	728

Getting Started

Once Leapfrog Geo is installed, there are some first steps to carry out before you begin working with projects. This topic describes those first steps and then provides an overview of Leapfrog Geo project files. This topic is divided into:

- [Licensing Leapfrog Geo](#)
- [Signing in to My Leapfrog](#)
- [Graphics and Drivers](#)
- [The Leapfrog Geo Projects Tab](#)
- [Managing Leapfrog Geo Projects](#)

Once you have carried out these first steps, see [An Overview of Leapfrog Geo](#) for a brief description of the different parts of the Leapfrog Geo main window. For more detailed information on using the controls in the different parts of the main window, see the following topics:

- [The Project Tree](#)
- [The 3D Scene](#)
- [Visualising Data](#)
- [Drawing in the Scene](#)
- [Organising Your Workspace](#)

Licensing Leapfrog Geo

To run Leapfrog Geo, you need a licence. There are two types, one that requires a Leapfrog USB dongle and one that requires the entry of a code.

Dongle Licences

If you have a USB dongle and need to activate your licence, plug the dongle in to your computer and start Leapfrog Geo. Leapfrog Geo will check the dongle and prompt you to start the activation process. Follow the instructions that appear on the screen.

If the licence cannot be installed, contact Customer Support as described in [Getting Support](#).

If you have an OnDemand licence, you will be prompted to check out days. In the window that appears, the bars show the maximum checkout period, divided into blocks; each block represents one day. Green blocks are active days remaining on your licence, and blue blocks are days available for checkout. Click blue blocks to select additional days; the blocks will turn orange to indicate the additional days you will be checking out.

2 | User Manual

You may also have module licences available, in which case you can click on the button for that licence and select the required number of days:

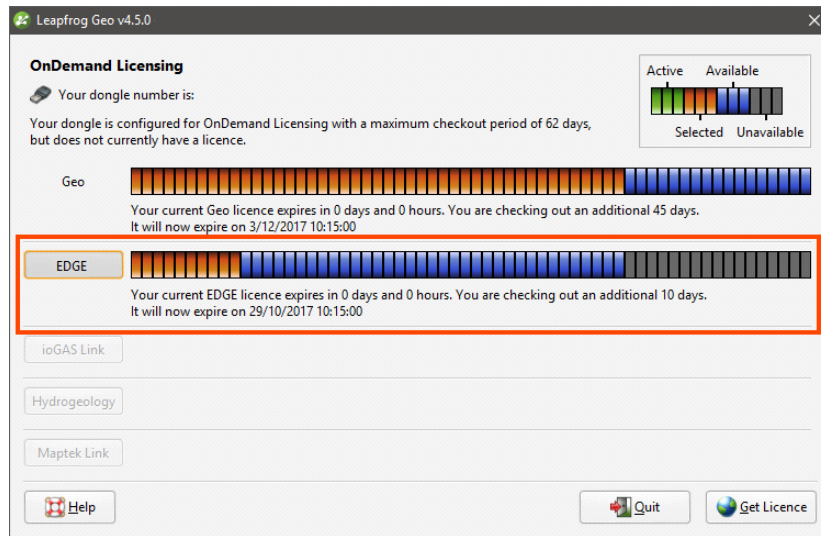

Click **Get Licence** to update your licence and check out the days indicated in orange.

Once Leapfrog Geo is running, you can check out additional days by selecting **Extend Licence** from the **Leapfrog Geo** menu or by clicking on the button at the bottom of the main window:



Once the licence has been activated, the licence details will be displayed. The **Module Licences** tab shows whether you have licences for any specialist modules.

If your licence has already been activated and you wish to activate or extend a module licence, select **Install Licence** (for a normal licence) or **Extend Licence** (for an OnDemand licence) from the **Leapfrog Geo** menu.

Code Licences

You may have a licence that requires the entry of a code. Start Leapfrog Geo and click **Enter Licence Code** in the window that appears. Enter the code you have been given and click **Get Started**.

You can copy the licence code from the email or document you received and paste it into the first **Licence Code** field.

If the code cannot be validated and you are sure you have entered the code correctly, contact Customer Support as described in [Getting Support](#).

Signing in to My Leapfrog

The **User Identity** menu in the upper right-hand corner of the main window is used to sign in to My Leapfrog.

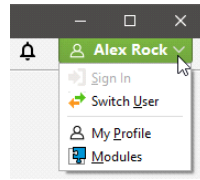

Signing in also signs you in to View, so you can upload scenes to View. The **My Profile** option takes you to My Leapfrog.

Graphics and Drivers

Many laptop computers come with two graphics options: low-powered graphics integrated into the CPU and a high-performance dedicated graphics option (a GPU). To save power, often the laptop's default setting is to run programs using the slower integrated graphics option. However, selecting high-performance graphics options is very important to Leapfrog's performance. If you have a dedicated graphics option, you should be using it. It's also important to have the most up-to-date drivers to make the most of your computer's capabilities.

To determine what graphics capabilities your computer has:

1. From the **Leapfrog Geo** menu, select **About**.
2. Click on the **System Info** tab.

Under the **Summary**, you will see the following details:

- **Graphics in use by** shows the graphics option being used. Note that Leapfrog Geo uses only the option indicated; if there are two options available, Leapfrog Geo does not use both simultaneously.
- **All available graphics hardware** lists the options available. If there are two options listed, you will want Leapfrog Geo to use the dedicated graphics option rather than the slower integrated graphics.
- **Driver date** shows the date at which the driver was last updated for each graphics option.

If your graphics drivers are out of date, it is recommended that they be updated prior to switching the graphics in use by Leapfrog Geo. To find more information:

- See the [Advanced Troubleshooting Guides](#) on the Leapfrog3D website for more information on how to update drivers for different types of dedicated graphics cards.
- Visit the My Leapfrog forums at <https://forum.leapfrog3d.com/c/open-forum> and search for "graphics".
- Contact technical support as described in [Getting Support](#).

Switching to High-Performance Graphics

If you have more than one graphics option available, ensure you are using the dedicated graphics capabilities to get the most out of Leapfrog Geo. The steps below apply to an NVIDIA driver and may be slightly different for other brands. Instructions for other brands can be found on the driver's or laptop manufacturer's website.

The first step is to open the NVIDIA Control Panel.

1. Right-click anywhere on your computer's desktop and select **NVIDIA Control Panel**.

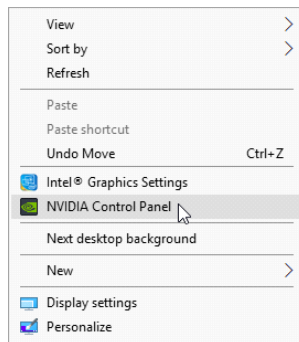

2. Click on **Manage 3D Settings**.
3. Click on the **Program Settings** tab.

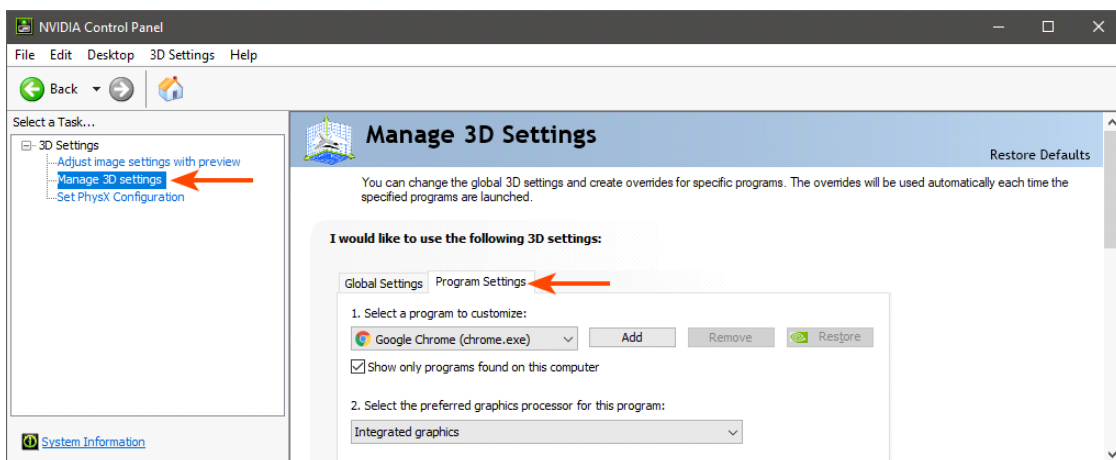

4. Under **1. Select a program to customise**, click the **Add** button.
5. Browse to the location of the Leapfrog Geo .exe file.

The default installation location is: C:\Program Files\Seequent\Leapfrog Geo4.5\bin\Geo.exe.

6. Once selected, click **Open**.

7. Under **2**, select the preferred graphics processor for this program, select the **High-performance NVIDIA processor**.

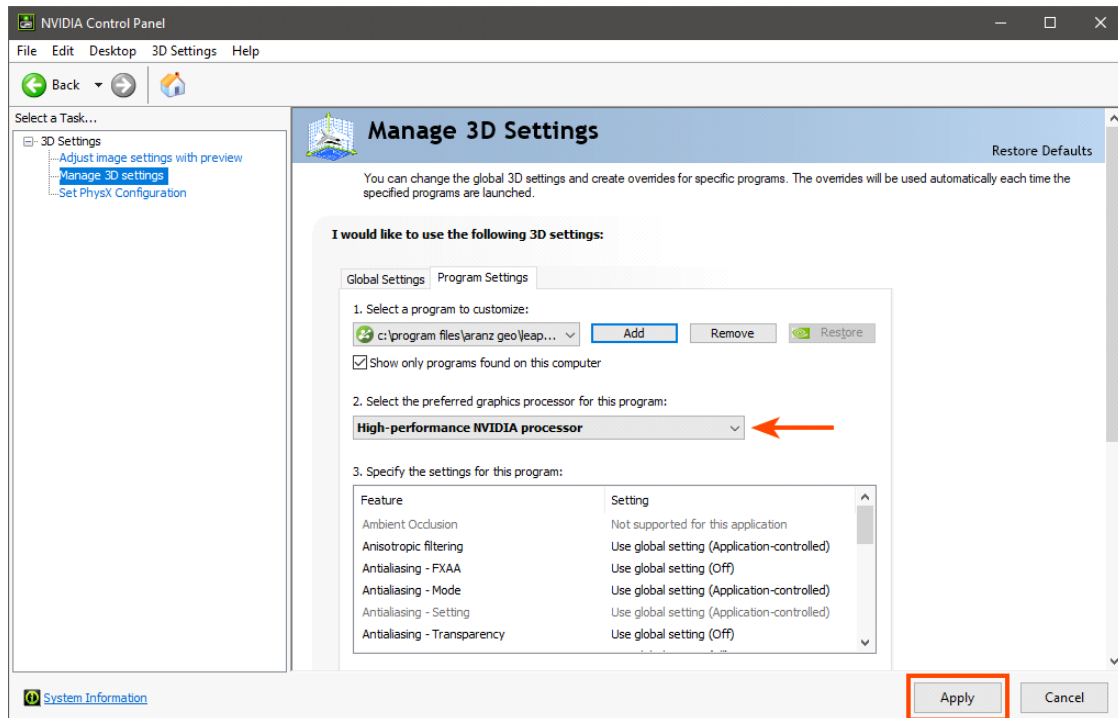

8. Click **Apply**.

On occasion, the graphics switch will be unsuccessful if the dedicated graphics card has old drivers. To ensure a successful switch, update your drivers before switching to your dedicated graphics card.

Once the drivers are updated and you have switched the in-use graphics card to your dedicated card, verify these changes have been successfully made.

9. Open the **System Info** window.

10. Check that the higher-powered NVIDIA card is now being used and that the drivers show the latest versions.

Running the Graphics Test

Leapfrog Geo can run in one of three acceleration modes. These modes are selected by clicking on the button at the bottom of the main window:

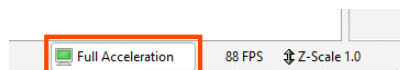

See [3D Acceleration Mode](#) in [Settings](#) for more information on these settings.

A newer computer will run in **Full Acceleration** mode without issues. However, if you are running Leapfrog Geo on a computer that is more than five years old, it is a good idea to run the graphics test to test your computer's graphics capabilities.

6 | User Manual

To start the test, open Leapfrog Geo and select **Test Graphics** from the **Leapfrog Geo > Diagnostics** menu:

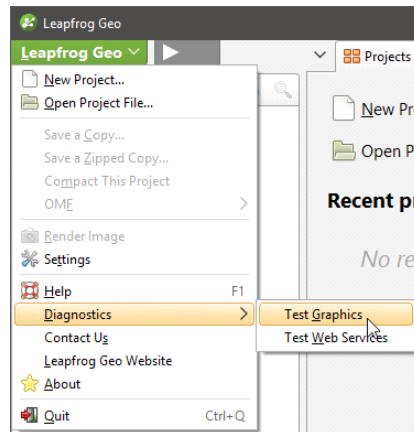

The graphics test displays a series of image pairs that test your computer's capabilities for the currently selected acceleration mode. For each pair, compare the images:

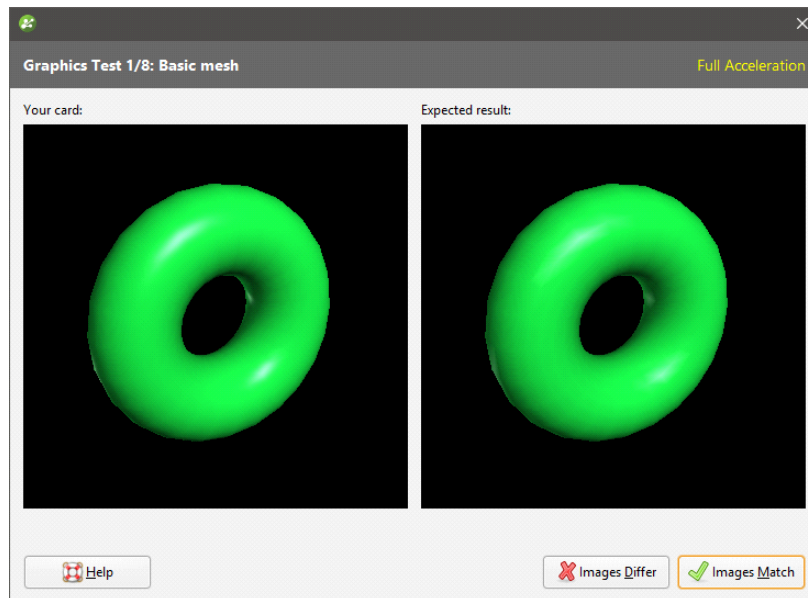

Even if the differences are slight, click the **Images Differ** button. If the images match, click the **Images Match** button. The next test will be displayed.

At the conclusion of the test, the result is displayed. If one or more tests have failed, information about solving problems will be displayed.

If you click on **Save Report**, you will be prompted to save the file on your computer.

If the test has failed, try switching to a different acceleration mode and running the test again. If possible, avoid using **Software Rendering** as it can be very slow.

If you cannot resolve the problem, save a copy of the graphics test report and contact technical support as described in [Getting Support](#). Be sure to include information about your system copied from the **About > System Info** tab.

The Leapfrog Geo Projects Tab

When you launch Leapfrog Geo, the main window will appear with the **Projects** tab displayed:

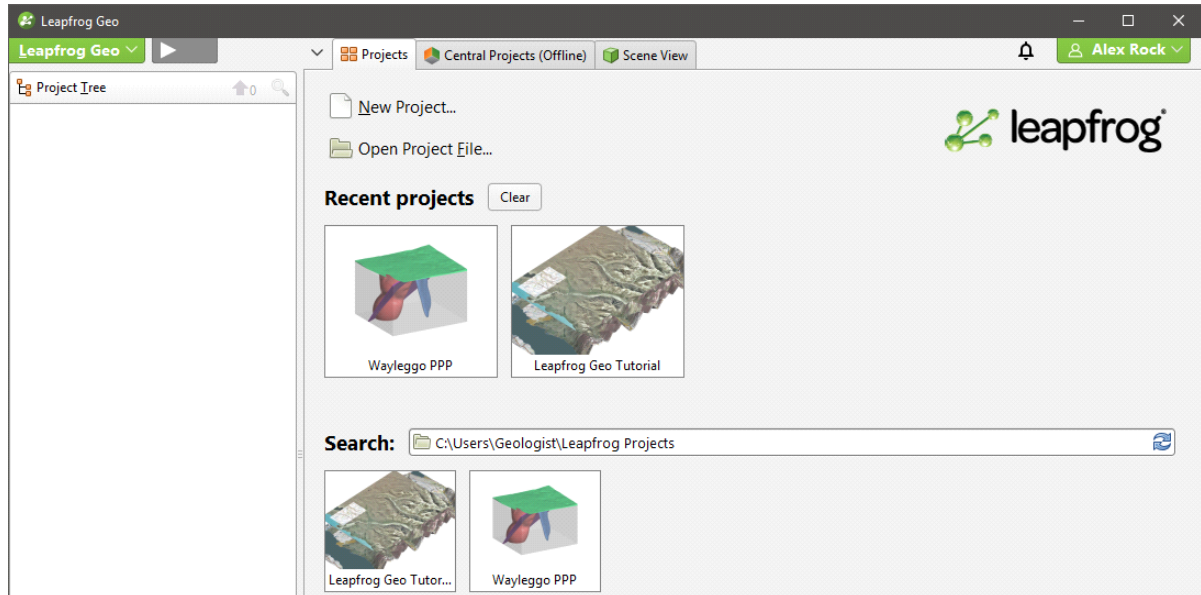

Thumbnails for the most recent projects are displayed in the **Recent projects** list. The second set of thumbnails is for projects contained in the **Search** folder:

- Click on the folder button (📁) or press the F5 key to change the **Search** folder. The **Search** folder is useful if you have one folder in which you keep most of your Leapfrog Geo projects.
- Click on the **Refresh** button (🔄) or press the F4 key to update the list of projects in the **Search** folder.

Leapfrog Hydro projects are indicated in the **Projects** tab. See [Converting Leapfrog Hydro Projects](#) for more information.

Click on a thumbnail to open a project. You can also navigate directly to the required project file by clicking on **Open Project File**.

Once a project file has been opened, Leapfrog Geo switches to displaying the **Scene View** tab.

See [Managing Leapfrog Geo Projects](#) below for more information on saving, compacting and upgrading projects.

Managing Leapfrog Geo Projects

If you and your team need to share projects, see <http://www.leapfrog3d.com/products/leapfrog-central> for information about Central, which is a model management system that lets groups of Leapfrog users share projects. See the [Central Integration](#) topic for more information on how Central and Leapfrog Geo work together.

To create a new project, click **New Project** at the top of the **Projects** tab. The new project will be saved in the **Search** folder.

Leapfrog Geo project files use the extension **.proj**. A folder is also created that contains information used by the project.

Do not change the name of your project folder or alter its contents. Doing so could render your project file unusable.

A **.lock** file is created when a project is opened. The **.lock** file protects the project from being moved while the project is open and from being opened by another instance of Leapfrog Geo, which can happen when projects are saved on shared network drives.

If processing and display of objects in your project is too slow and your project is stored on a network drive or on a USB drive, consider moving your project onto a local drive. Leapfrog Geo is optimised for working off your local hard drive, and working from network drives and USB drives risks corrupting the project.

Saving Projects

Leapfrog Geo automatically saves an open project each time a processing task has been completed or settings have changed. Projects are also saved when they are closed so that scene settings can be restored when the project is next opened.

Saving Zipped Copies of Projects

You can save a zipped copy of a project by selecting **Save A Zipped Copy** from the **Leapfrog Geo** menu. You will be prompted to choose a name and location for the zipped project. Click **Save** to create the zip file.

Saving Backup Copies of Projects

You can save a backup copy of a project by selecting **Save A Copy** from the **Leapfrog Geo** menu. You will be prompted to choose a new name and location for the saved project. Click **OK** to create the new project file. Leapfrog Geo will save a copy of the project in the location selected.

Once the backup copy is saved, you can open and use it from the **Projects** tab. Otherwise, you can keep working in the original copy of the project.

Compacting Projects

When you delete objects from a project file, Leapfrog Geo retains those objects but notes that they are no longer used. Over time, the project file will grow in size and data stored in the database may become fragmented.

Compacting a project removes these unused objects and any unused space from the database. When you compact a project, Leapfrog Geo will close the project and back it up before compacting it. Depending on the size of the project, compacting it may take several minutes. Leapfrog Geo will then reopen the project.

To compact a project, select **Compact This Project** from the **Leapfrog Geo** menu. You will be asked to confirm your choice.

Upgrading Projects

When you open a project that was last saved in an earlier version of Leapfrog Geo, you may be prompted to upgrade the project. A list of affected objects will be displayed. For large projects with many objects that need to be reprocessed, the upgrade process may take some time.

It is a good idea to back up the project before opening it. Tick the **Back up the project before upgrading** button, then click **Upgrade and Open**. Navigate to the folder in which to save the backup and click **Save**.

For large projects with many objects, upgrading without backing up the project is not recommended.

Converting Leapfrog Hydro Projects

Leapfrog Hydro projects can be converted to Leapfrog Geo projects. However, the process is one-way, and projects opened in Leapfrog Geo can no longer be opened in Leapfrog Hydro.

When you open a Leapfrog Hydro project, you will be prompted to save a backup before converting the project.

It is strongly recommended that you back up the project before converting it.

What is Implicit Modelling?

Implicit modelling is a game-changing innovation in geological modelling.

Traditionally, geological models are produced using a manual drawing process. Sections are defined, and lithologies, faults and veins are drawn on the sections. Lines are then drawn to connect surfaces across multiple sections. Modelling geology in this manner is time-consuming and inflexible as it is difficult to update the model when more data becomes available. Early assumptions that later are proved incorrect could shape a model in a way that is never corrected because of the effort involved in starting over. Instead of using their knowledge to reveal important information about the study site, geologists spend significant proportions of their time engaged in mechanical drawing.

Implicit modelling, on the other hand, allows geologists to spend more time thinking about the geology. Implicit modelling eliminates the laborious legwork by using mathematical tools to derive the model from the data. A mathematical construct is built that can be used to visualise different aspects of the data in 3D. Leapfrog Geo uses FastRBF™, a mathematical algorithm developed from radial basis functions. FastRBF uses the data and parameters supplied by the geologist to derive any one of a number of variables to be modelled. Discrete variables such as lithologies can be used to construct surfaces, as well as continuous variables such as ore grades.

Instead of presenting a model constructed from rigid geometric constructs, the visualisations echo the natural forms found in reality.

What are the Advantages of Implicit Modelling?

Implicit models are easy to keep up-to-date with the latest data. New drillhole data can quickly be integrated, instead of taking weeks or longer manually modifying the model.

Implicit modelling allows several alternative hypothetical models to be produced from the data, quickly and easily. New data that affects the model, even in very significant or fundamental ways, can be assimilated and integrated with little effort. Models can be built rapidly, which means that a range of geological interpretations can be continually tested.

Because less effort is involved in creating a model, more time is available to spend on understanding the geology and studying more complex details such as faulting, stratigraphic sequences, trends and veins. The model can be developed to reflect reality to a greater degree of precision than was previously possible.

Geological risk is reduced when modelling is done implicitly. With traditional modelling, the effort involved means that the first model developed may be held to as the ground truth, despite mounting evidence that may discredit it. Instead, implicit modelling supports an approach that follows the proven scientific method, developing hypothetical models, experimenting to find new data to corroborate or discredit models and, ultimately, allowing the best model to be revealed. A geologist can experiment with alternative parameters at the limits of what is geologically reasonable to determine if there is any significant variation in the resulting models, which can then bracket the model with conceptual error bars. Geostatistical analysis can be conducted to identify what models are the most valid.

It is easy to change your mind when modelling implicitly. Perhaps models have been produced demonstrating isometric shells enclosing specific grades of ore. Commodity price changes then make it desirable to recreate the model using alternative ore grade values. If the model had been produced manually, doing so would not be practical. But with implicit modelling, the ease of generating a new model with new interpolation parameters means this valuable business information can be readily produced.

New questions can be answered more easily. A model tends to answer one question or class of questions well, and new questions require new models. If a model takes months to produce, those new questions may remain forever unanswered. If it can be produced with only days or hours worth of effort, valuable insights can be gained that could provide critical business value.

Implicit Modelling Makes Assumptions Explicit

Often, there is insufficient information in the data alone. For instance, drillhole data may well need to be supplemented with known details about the geology. When a geologist is constructing a model using traditional techniques, they use their knowledge of the geology to make decisions about the model as it is constructed. This is something the geologist will do automatically, which irretrievably conflates measured data with hypothesised data, hiding away subjective assumptions that have influenced the development of the model.

Implicit modelling, however, keeps the measured data separate from interpretations. The geologist can use polylines and structural disks to interpret the data without equating them to measured data. Implicit modelling makes assumptions explicit; there is a clear separation between hard data and user-introduced interpretations.

Implicit modelling and the presentation of a selection of models communicating different aspects of the geology provide new tools a geologist can use to communicate with professionals in other parts of the business.

On a purely business level, specialist staff can be putting their skills to use in productive, valuable geological modelling, rather than drawing lines on sections ad infinitum.

Implicit models are more repeatable and, therefore, more auditable, because they are derived from actual data and explicitly communicated geological interpretations, with selected parametric variables as inputs and processed using a mathematical algorithm.

The only thing implied in implicit modelling is the unknown value between two known values. Everything else is explicit. For this reason, it is best to refer to traditional modelling techniques as 'traditional modelling' rather than 'explicit modelling', assuming that it should be labelled with a name that is the inverse of 'implicit modelling'. Implicit modelling is much more explicit than traditional modelling.

Best Practices

- **Analyse data.** Analyse your data using drillhole interpretation and data visualisation tools. Use 3D visualisation to look for errors in the data set.
- **Stay focussed.** Produce a model that answers a specific question or addresses a specific problem. Don't unnecessarily model all the data available just because it is there. When a new question is asked, produce a model that answers that question using the necessary data.

- **Experiment and explore.** Produce variations of the same model, or even models, using quite different fundamental assumptions. Plan drillholes that will help reveal what model fits best and then discard models that are inconsistent with new data.
- **Understand risk.** Model using a range of input parameters and assumptions to understand the level of geologic risk.
- **Share.** Discuss and explore alternatives.
- **Adapt.** Previously, the effort of production and review of traditional models meant that there is reluctance to rebuild a model when new data becomes available soon after model completion. However, with implicit modelling, you should integrate new data and refine the model as soon as the new data is available. The revised model could indicate that planned activities should be redirected as expensive resources would be wasted persisting with the original plan, for little return.
- **Evaluate and review.** Don't assume that because it's easy to generate a model that you have quickly produced the right model. Understanding the geology is vital for validating the model and producing something that is geologically reasonable.

An Overview of Leapfrog Geo

This topic provides an overview of the different parts of the Leapfrog Geo main window. For more detailed information on using the controls in the different parts of the main window, see the following topics:

- [The Project Tree](#)
- [The 3D Scene](#)
- [Visualising Data](#)
- [Drawing in the Scene](#)
- [Organising Your Workspace](#)

If you are new to Leapfrog Geo, it is a good idea to go through the tutorials, which introduce basic concepts. The tutorials take two to four hours to complete and will get you to the point where you can start processing your own data. To download the tutorials, visit

<http://help.leapfrog3d.com/Geo/4.5/en-GB/Content/tutorials.htm>.

The Leapfrog Geo main window is divided into three main parts:

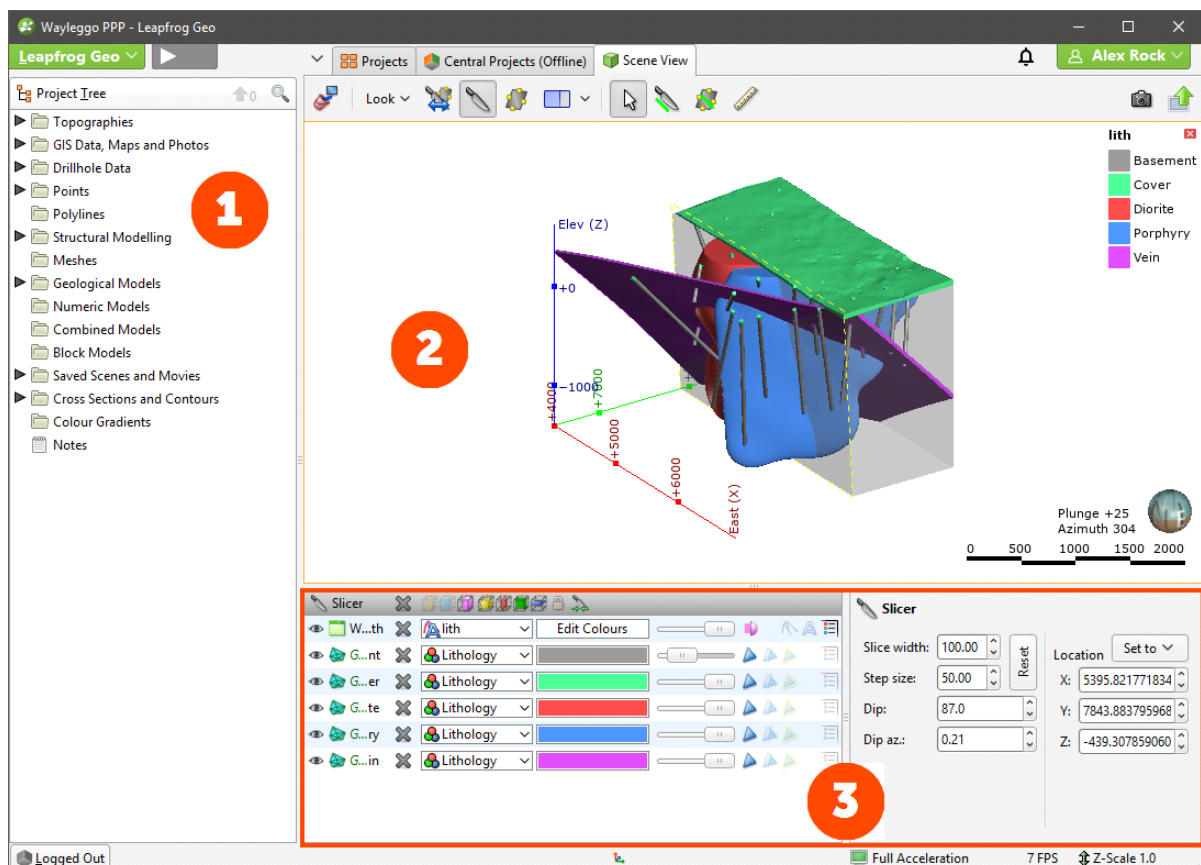

1

The **Project Tree** contains all the data in the project and tools for working with that data. When you want to change how this data is used in the project, work with the objects in the project tree. See [The Project Tree](#).

2	The Scene View tab displays a 3D representation of selected objects from the project tree. Changing how you view objects in the scene window does not change those objects in the project tree. See The 3D Scene .
3	Tools for changing the appearance of data in the scene window are available in the shape list and the shape properties panel. Changing the appearance of these objects does not change those objects in the project tree. See Visualising Data .

You can add objects to the scene window by dragging them from the project tree. You can temporarily hide them in the scene or remove them altogether using the controls in the shape list.





Leapfrog Geo is unit-less and adopts the units used in the data you import. For example, if your imported data is in metres, the units displayed will be metres, and figures such as resolution, measured distances and slicer thickness will be in metres. It is important, therefore, to be consistent in the units used in the data you import. If you are importing data that uses different coordinate systems, you will need to pre-process the data so that it is using the same coordinate system.

When you open a Leapfrog Geo project, the project is displayed in the state it was in when it was closed.

Keyboard Shortcuts in the Main Window

Use the Tab and Shift+Tab keys to move between the different parts of the main window in the following order:

- Project tree
- Scene toolbar
- Scene window
- Shape list
- Shape properties panel

Key(s)	Action
F8	Maximise scene, minimise project tree and shape list. Press F8 again to restore.
Ctrl+1	Activate the Select tool 
Ctrl+2	Activate the Draw slicer line tool 
Ctrl+3	Activate the Draw plane line tool 
Ctrl+4	Activate the Ruler tool 
F10 or Alt L	Open the Leapfrog Geo menu
F1	Open Leapfrog Geo help
Ctrl+Q	Quit Leapfrog Geo

The Project Tree

The series of folders in the project tree are used to organise objects such as datasets, maps and images into categories. These folders also provide tools that let you import information into the project and generate models. Right-click on each folder to view the actions you can perform using that folder.

This topic provides an introduction to working with the project tree. It is divided into:

- [Organising Objects in the Project Tree](#)
- [Restricted Objects](#)
- [Object Properties](#)
- [Comments](#)
- [Processing Tasks](#)
- [Project Tree Keyboard Shortcuts](#)

You can also right-click on objects within the top-level folders to view more information on that object or carry out actions specific to that object. For example, right-clicking on a table of imported drillhole data reveals a menu showing possible actions:

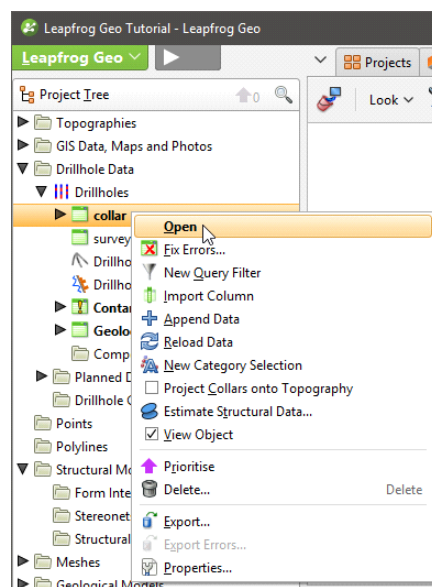

When a bold option appears in the right-click menu, as **Open** does in the menu above, that option can also be selected by double-clicking on the object.

You can select more than one object in the project tree by holding down the Shift key or the Ctrl key while clicking. This is useful for viewing or deleting multiple objects at once.

The way folders and objects are organised in the project tree lets you reveal or hide information about an object to focus on objects you are currently working with. This is also useful when you are exploring a project and want to determine how something was put together. The arrows next to objects in the project tree let you reveal or hide an object's details to focus on objects you are currently working with. Here, the **Topographies** folder is expanded to show a **Topography** object that is made up of a mesh:

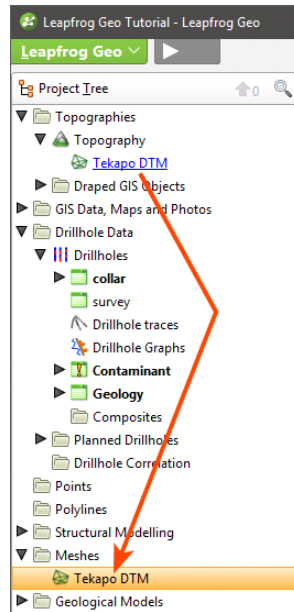

Also note that:

- The mesh itself is stored in the **Meshes** folder, but is hyperlinked to from wherever it is used in the project.
- The **Drillhole Data** folder and the **Drillholes** object have been expanded to show the drillhole data tables.
- Folders that have no arrow have no detail stored.

Expanding a data table (📄) shows the columns in that table contains, including category data columns (📁), numeric data columns (📊) and query filters (🔍):

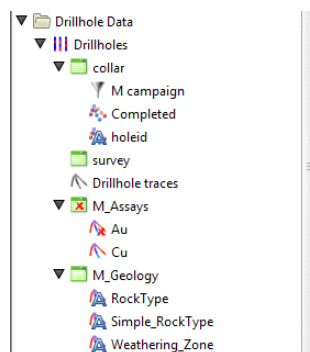

Some tables are marked as having errors (🚫), which are discussed in [Identifying Errors in Data Tables](#).

Expanding a geological model reveals information about how it was built. Here, a geological model has been expanded to show the basic objects that make up a model:

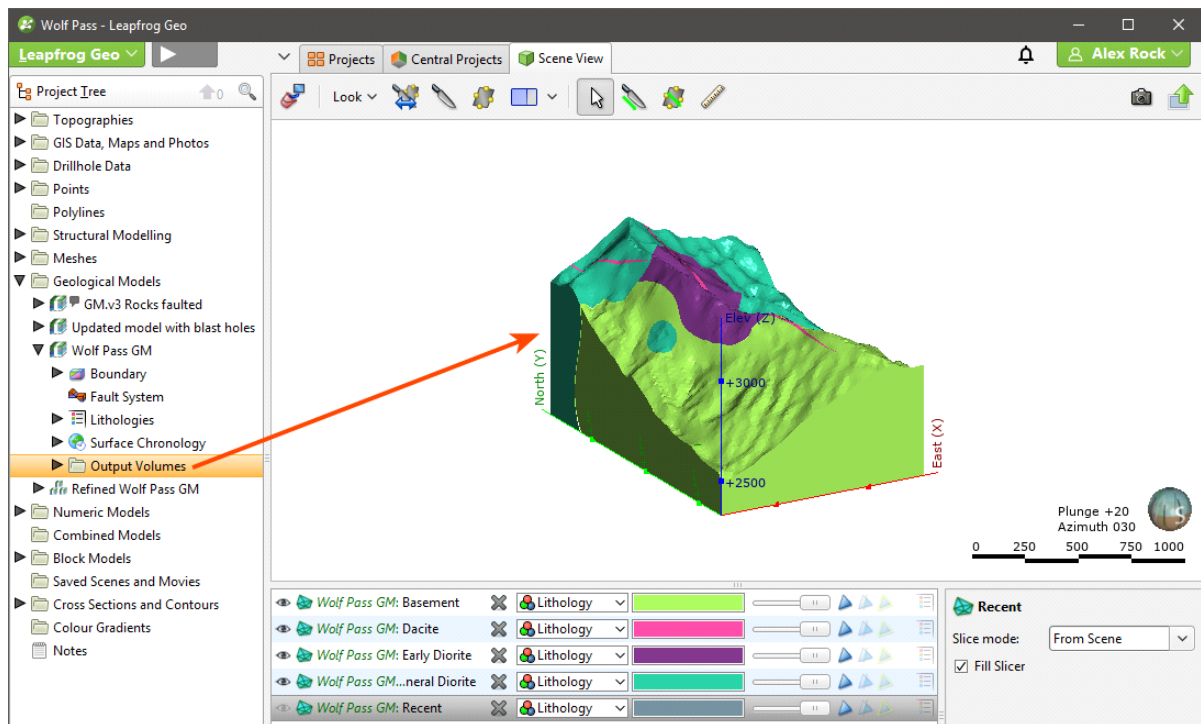

The five objects underneath the geological model “GM” represent the five basic parts of a geological model:

- The **Boundary** object defines the outer limits of the geological model.
- The **Fault System** object defines faults and their interactions in the geological model.
- The **Lithologies** object defines the lithologies in the model.
- The **Surface Chronology** object defines the structure of the model’s contact surfaces.
- The **Output Volumes** folder contains the generated units (outputs) that make up the geological model.

Here, boundary objects for a geological model have been expanded to show how they were created:

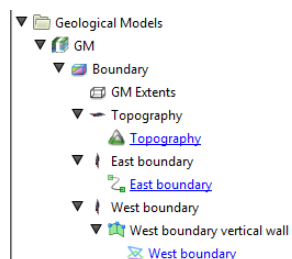

The **Topography** object is included as the model’s upper boundary. The “East boundary” object was created using a polyline from the **Polylines** folder and the “West boundary” object was created using a GIS data object in the **GIS Data, Maps and Photos** folder. Clicking on the hyperlinks will locate the object from which the extent was created.

Organising Objects in the Project Tree

Leapfrog Geo has a number of tools to help you organise the large numbers of objects in a project. One of these tools is the use of display lines in the project tree to better show relationships:

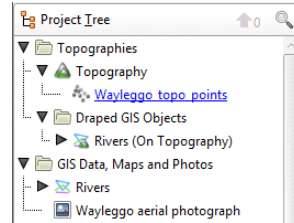

If you wish to display line in the project tree, open the **Settings** window from the **Leapfrog Geo** menu. Click on **User Interface** and enable **Show Tree Lines**.

When you have a large number of folders open in the project tree, you can close all folders by right-clicking on the top of the project tree and selecting **Collapse All**:

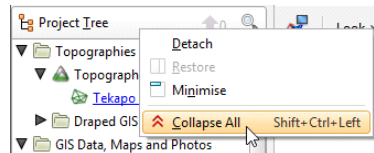

Hotkeys for opening and closing folders include:

- Ctrl + shift + left arrow collapses all folders.
- Right arrow expands a collapsed folder or object but keeps child objects collapsed.
- Shift + right arrow expands a collapsed folder or object and child objects.
- Left arrow collapses an expanded folder or object but keeps child objects expanded.
- Shift + left arrow collapses an expanded folder or object and child objects.

Hotkeys work with more than one object selected.

Subfolders

In many project tree folders, you can create subfolders that help in organising large numbers of data objects. For example, here colour gradients have been organised into subfolders:

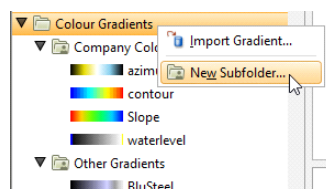

To add a subfolder, right-click on a folder in the project tree and select **New Subfolder**. Add objects to subfolders by dragging and dropping them. You can also use **Cut** (Ctrl-X) and **Paste** (Ctrl-V) shortcuts to move objects and subfolders.

Subfolders can be renamed, moved and deleted, but cannot be moved to other top-level folders.

Subfolders have the same right-click commands as their parent folder, which means you can import or create new data objects inside the subfolder rather than in the parent folder. You can also add comments to folders to aid in keeping data organised:

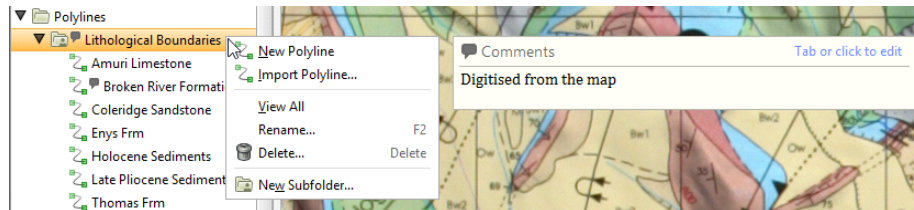

You can view all objects in the subfolder by dragging the folder into the scene or by right-clicking on the subfolder and selecting **View All**.

When lists of objects are displayed, the subfolder organisation will be reflected in the list. For example, when creating an interpolant, the list of data objects that can be interpolated is displayed organised by subfolder:

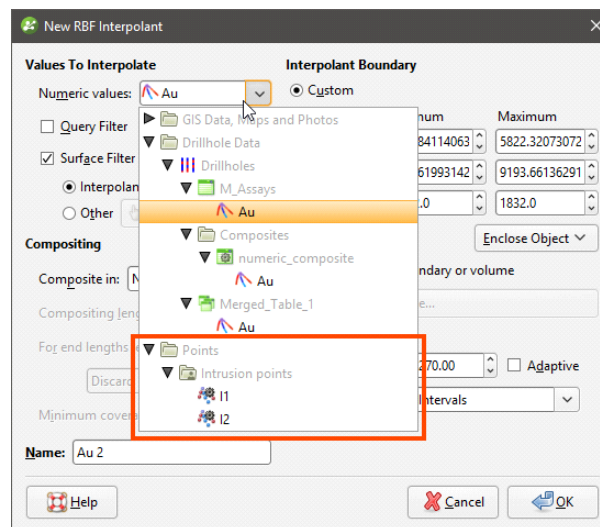

Subfolders cannot be created in the **Drillhole Data** folder, although they can be created in the **Composites** and **Planned Drillholes** folders.

Copying Objects

Many objects in the project tree can be copied. Right-click on an object and select **Copy**. You will be prompted to enter a name for the object's copy.

The copied object is not linked to the original object. However, if the original object is linked to other objects in the project, the copy will also be linked to those objects.

Renaming Objects

When an object is created in Leapfrog Geo, it is given a default name. It is a good idea to give objects in Leapfrog Geo names that will help you distinguish them from other objects, as large projects with complicated models will contain many objects.

To rename an object in the project tree, right-click on the object and select **Rename**. The **Rename Object** window will be displayed:

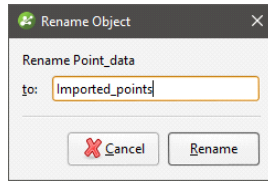

Enter a new name for the object. Click **Rename** to change the object's name.

Finding Objects

To find objects in the project tree, click the search button at the top of the project tree:

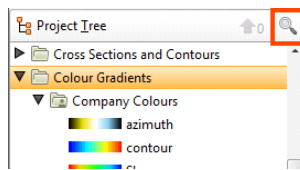

You can also click anywhere in the project tree and type "Ctrl-F".

The **Find** window will be displayed:

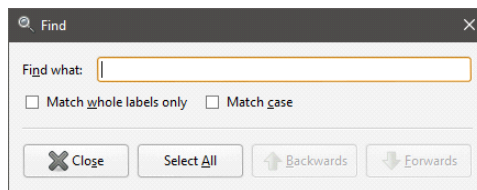

Enter the information you are searching for, then click **Backwards** or **Forwards** to locate the object in the project tree.

Deleting Objects

When you delete an object from the project tree, a window will be displayed listing all other objects in the project that will also be deleted and those that will be reprocessed. Some objects will be put into an error state; you will need to correct those errors before the affected object can be used elsewhere in the project.

Consider carefully the effects on other objects in the project, as once an object is deleted, it cannot be recovered.

Deleting data from the project may cause other objects to be reprocessed, which can take some time.

To delete more than one object from the tree, hold down the Shift key or the Ctrl key while selecting objects.

Sharing Objects

Some objects are created as part of working with other objects and are not available elsewhere in the project. An example of this is a polyline drawn as part of creating a model boundary. To share such objects within the project, right-click on the object in the project tree and click **Share**. The shared object will be copied to the relevant location in the project tree and a hyperlink added to the object it was shared from.

For example, here a polyline created as part of a lateral extent is shared:

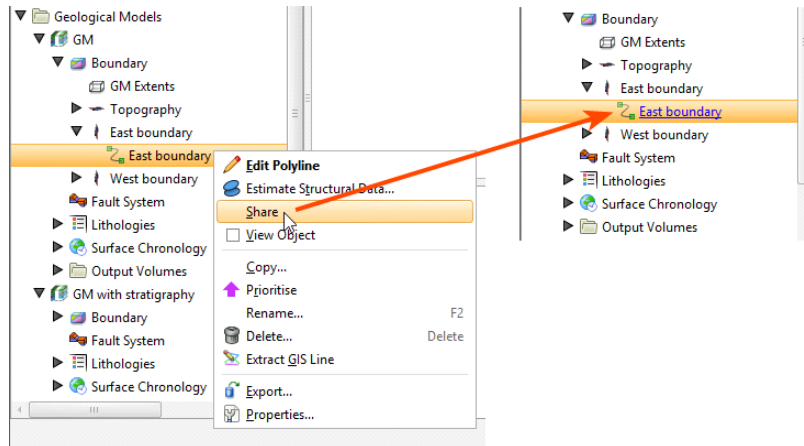

The polyline is saved to the **Polylines** folder and a hyperlink to it appears as part of the model's boundary. Whenever the polyline is updated, changes will be made wherever it is shared in the project.

Polylines that have been shared can be unshared. See [Sharing and Unsharing Polylines](#) for more information.

Restricted Objects

Some objects may appear in the project tree as restricted:

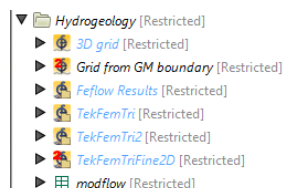

Restricted objects were created using features only available in modules. You can display restricted objects in the scene and change how they are displayed, but you cannot make changes to the objects themselves. When changes are made to objects that are inputs to restricted objects, the restricted objects will not be processed. Instead, they will remain in the processing queue marked as "frozen". Frozen objects are indicated in the project tree in blue.

Contact Customer Support as described in [Getting Support](#) for more information about licensing modules.

Object Properties

You can view the properties of most objects imported into or created in Leapfrog Geo. To do this, right-click on the object in the project tree and select **Properties**.

The information available in the **Properties** window depends on the type of object. Tabs may include:

- A **Processing** tab that shows the current status of the processing (queued to process, processing, finished).
- An **Errors** tab that displays errors that have occurred while processing the object. See [Processing Tasks](#).
- A **General** tab that summarises information about the object. The amount of information in the **General** tab will vary according to the type of object. For example, for table objects, the **General** tab shows the table's data structure.
- A **Statistics** tab that shows statistics for some types of interpolants.
 - For RBF interpolants, see [RBF Interpolant Statistics](#).
 - For multi-domained RBF interpolants, see [Sub-Interpolant Statistics](#).
 - For indicator RBF interpolants, see [Indicator RBF Interpolant Statistics](#).

Comments

Another aid to documenting work in a project is comments.

You can record comments on many objects in the project tree, including subfolders. This can be helpful when the project contains many objects and when several different people are working on a model. Objects that have comments are indicated in the project tree by a comment balloon (🗨). The comment will be displayed when you right-click on the object:

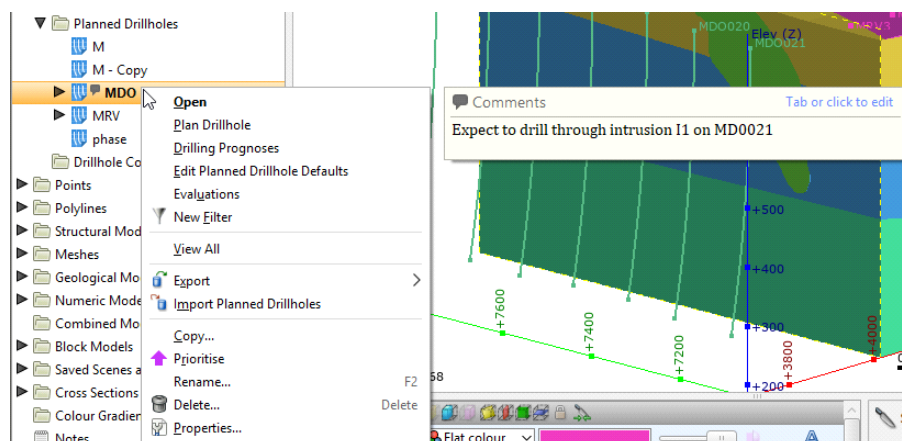

Tab or click to add a new comment or edit an existing one. You can also add standard information to a comment, such as date and time. If you add a URL to a comment, it will be converted to a clickable link.

You can add information about the project as a whole using the **Notes** object (📄), which is the last object in the project tree. Double-click on the **Notes** object to open it and add information. When viewing projects in the **Projects** tab, information in a project's **Notes** will be displayed when you hold the mouse cursor over the project's thumbnail:

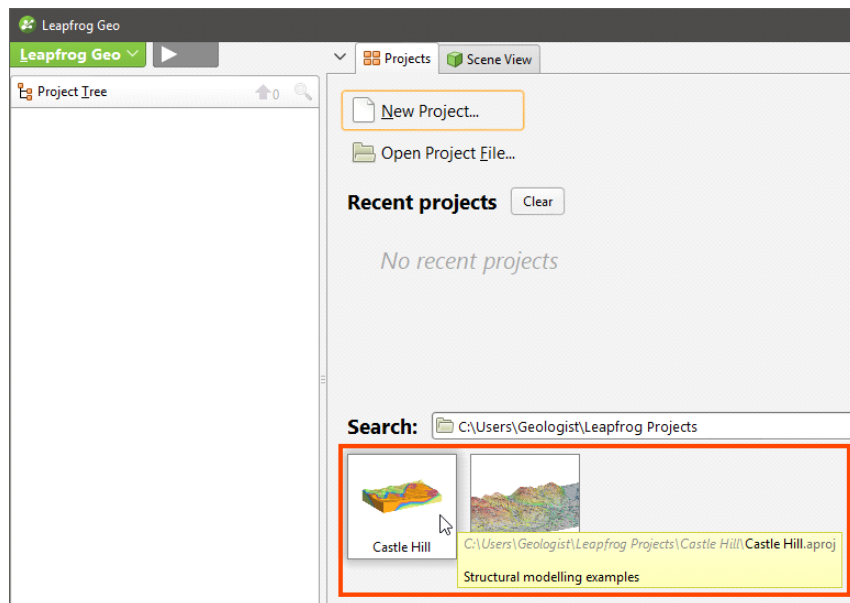

Processing Tasks

The processing queue button shows how many tasks are currently being processed:

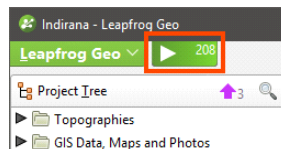

Objects will be added to the processing queue when you make changes to them via the project tree.

- To view the queue and progress on processing, click the queue button or press Alt + P.
- To pause processing, press Ctrl + P. To resume processing, press Ctrl + P again.

The button will turn grey when all processing is complete. Some items may remain in the processing queue, marked as "frozen". These objects are restricted objects that cannot be reprocessed without a licence. See [Restricted Objects](#) for more information.

You can close a project while it is still running tasks. When you next open the project, the remainder of the tasks in the processing queue will be processed.

Prioritising Tasks

Tasks can be prioritised and their inputs processed before other objects. To prioritise a task, right-click on an object in the project tree and select **Prioritise**. Prioritised tasks are marked in the project tree with an arrow:

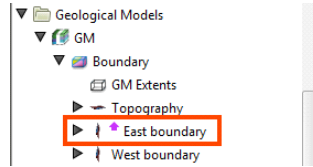

Prioritising an object is useful when you are editing it and wish to view the effect of changes without reprocessing all objects in the project. For example, you may be modifying a surface that is used for a model boundary. You can prioritise the surface, then run it each time you make changes.

To run only prioritised tasks, click the processing queue button, then click **Priority Only**:

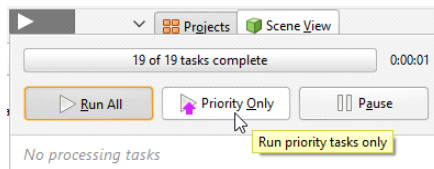

The processing queue button will change to show that only priority tasks will be run:

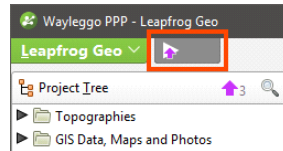

The number of objects that have been prioritised is indicated by the button at the top of the project tree (↑ 3). To view prioritised tasks, click the button. All prioritised objects will be selected and displayed in the project tree.

To reset a priority object, right-click on it and select **Clear Priority**.

Click the processing queue button, then click **Run All** to resume normal processing.

Correcting Errors

If processing of an object fails, all other objects dependent on that object will also fail. Click the processing queue button to view the errors. To inspect the source of error, right-click on the object in the task queue and select **Go to Project Tree > Show Error**:

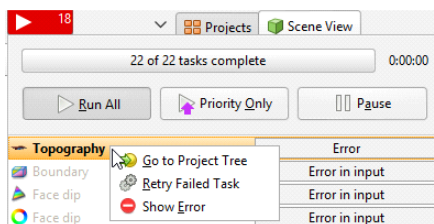

The object's **Properties** window will be opened with the **Errors** tab displayed. The information in this tab may be helpful in fixing the error.

Project Tree Keyboard Shortcuts

Keyboard shortcuts for navigating in the project tree are as follows:

Key(s)	Action
Up and down arrows	Navigate up and down the tree
Right arrow	Expand folder/object or go down one level
Left arrow	Close folder/object or go up one level
Ctrl+shift+left arrow	Close all folders/objects
Shift+right arrow	Expand the selected folder/object and any objects in it
Shift+left arrow	Close the selected folder/object and any objects in it
Ctrl+A and Ctrl+/ Ctrl+F	Selects all folders and objects
Ctrl+F	Search for objects
Enter	The equivalent of double-clicking on an object
Ctrl-X	Cut an object or subfolder. Use with Ctrl-V to move objects and subfolders.
Ctrl-V	Paste an object or subfolder

Some actions are not available until data has been imported into the project.

The 3D Scene

This topic describes how to interact with the 3D scene. It is divided into:

- [Locating an Object from the Scene](#)
- [Slicing Through the Data](#)
- [Measuring in the Scene](#)
- [Working With Split Views](#)

How to change the way objects are displayed in the scene is described in a separate topic, [Visualising Data](#).

The best way to navigate the 3D scene in Leapfrog Geo is using the mouse. If you are running Leapfrog Geo on a laptop, it is recommended that you plug in a mouse rather than using the laptop's touchpad for navigation. However, you can also navigate in the scene using the keyboard.

Action	Mouse	Keyboard
Changing the viewing angle	Click and drag to rotate the scene	Press the arrow keys to rotate the scene For smaller steps, hold down the Shift key while pressing the arrow keys
Zooming in and out of the scene	Use the scroll wheel Hold the right mouse button while moving the mouse	Press the Page Up or Page Down keys For smaller steps, hold down the Shift key while pressing the Page Up or Page Down keys
Panning the scene	Click and hold both mouse buttons, then drag Hold the scroll wheel and drag	Hold down the Alt key while pressing the arrow keys
Centre an object in the scene	Click the scroll wheel Click both mouse buttons together	

Use the **Look** menu above the scene window to switch to different viewing angles:

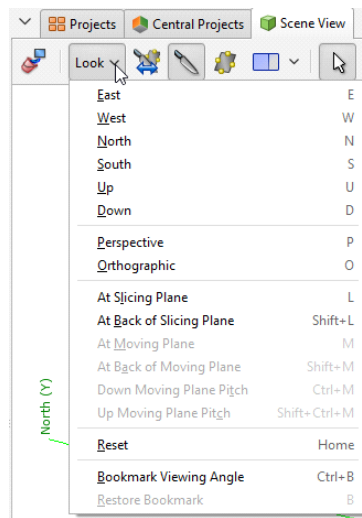

If you prefer to navigate using the keyboard, use the following keyboard shortcuts:

Key(s)	Action
Arrow keys	Rotate the scene in 10 degree steps
Shift+Arrow keys	Rotate the scene in 2 degree steps
Home	Reset the view, showing all visible objects in scene
U, D, E, W, N, S	Look Up, Down, East, West, North and South
L	Look at the slicing plane
Shift+L	Look at the back of the slicing plane
M	Look at the moving plane
Shift+M	Look at the back of the moving plane
Ctrl+M	Look down the moving plane pitch
Shift+Ctrl+M	Look up the moving plane pitch
P	Select Perspective view
O	Select Orthographic view
Ctrl+Delete	Clear the scene
Ctrl+B	Bookmark the viewing angle and zoom
B	Display the bookmarked viewing angle and zoom
Ctrl+'	Save the scene
Ctrl+C	Copies the scene to the clipboard. The image can then be pasted into another application, such as an image editor.
Ctrl+/'	Add the slicer to the scene. Press Ctrl+/' to remove the slicer from the scene.
Ctrl+;	Add the moving plane to the scene. Press Ctrl+; to remove the moving plane from the scene.

The current viewing angle and scale are displayed in the lower right-hand corner of the scene window:

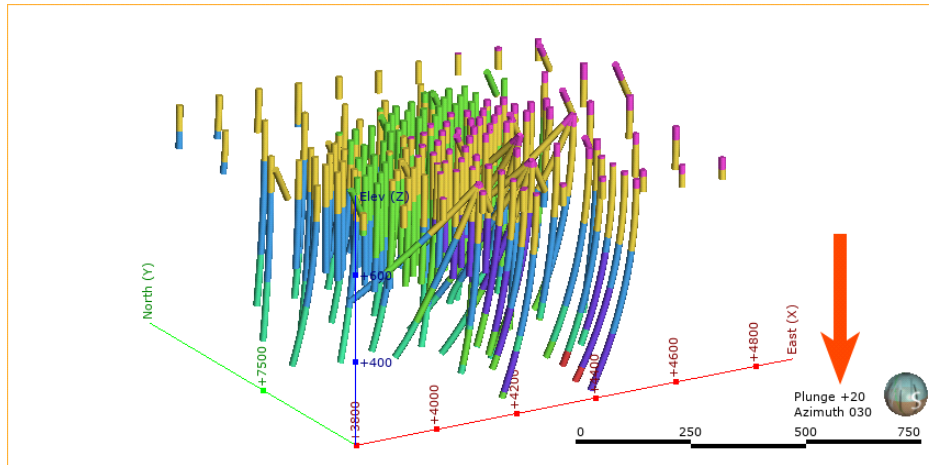

You can change how the viewing angle and scale are displayed in the **Overlays** tab of the **Settings** window.

You can save the current viewing angle as a bookmark by selecting **Bookmark Viewing Angle** from the **Look** menu or by pressing Ctrl+B. Restore the bookmark by selecting **Look > Restore Bookmark** or by pressing B.

Only one viewing angle bookmark can be saved. The bookmark is not saved when Leapfrog Geo is shut down.

The scene window displays a 3D representation of selected data from the project tree. You can add objects from the project tree to the scene in two ways:

- Click on the object and drag it into the scene. Hold down the Shift key or the Ctrl key while clicking to select multiple items, then add them to the scene.
- Right-click on the object and tick the **View Object** box.

Dragging objects into the scene window may be blocked by other applications on your computer. For example, if you are sharing a screen using Skype, you will not be able to drag objects into the scene.

Once you have added objects to the scene window, you can change the appearance of those objects using the controls in the shape list and the shape properties panel.

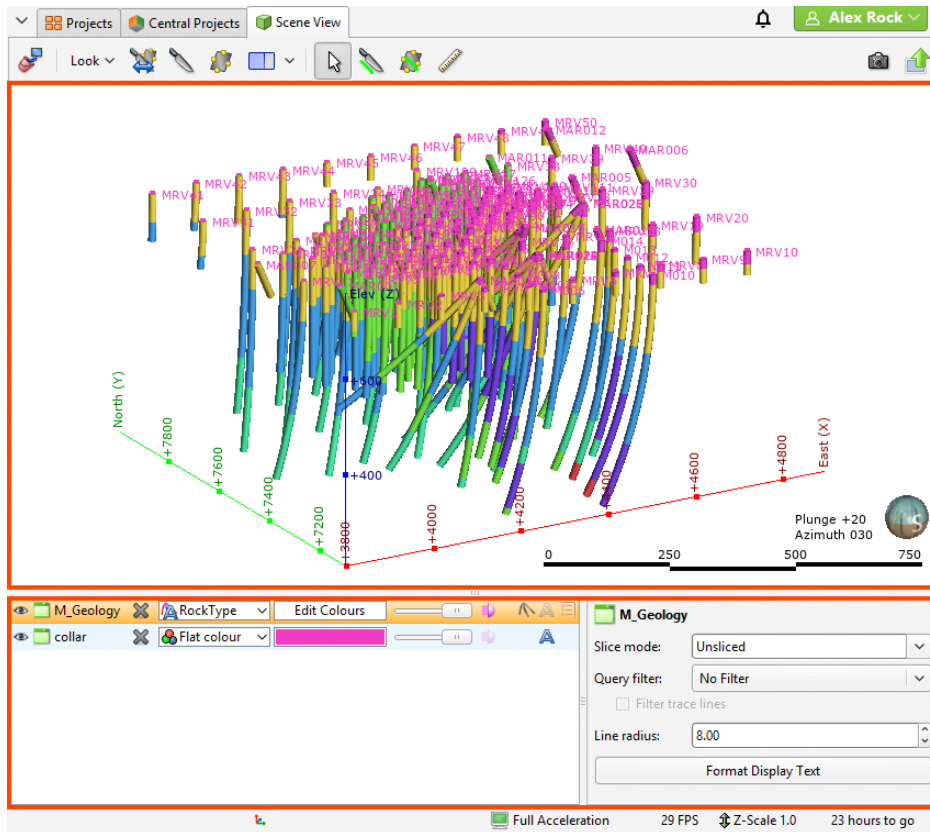

This is described further in [Visualising Data](#).

Changing how you view objects in the scene window does not change those objects in the project tree.

All objects in the shape list have a button (✕) that will remove the object from the scene. Most objects also have a visibility button (👁) that can temporarily hide that object in the scene. It is often easier to make an object temporarily invisible than to remove it from the list. Some objects have an edit button (🍷) that you can click to begin editing the object.

Locating an Object from the Scene

When you have a number of objects displayed in the scene, it may not be readily apparent where you can find more information about those objects. Leapfrog Geo helps you find the object in the project tree and the shape list in two ways, by [Clicking in the Scene](#) and by [Clicking in the Shape List](#).

Clicking in the Scene

Clicking on an object in the scene displays a window that contains a summary of the data and, for many objects, a link to the corresponding data in the project tree. For example, here drillhole data is displayed in the scene and clicking on a segment displays the corresponding data:

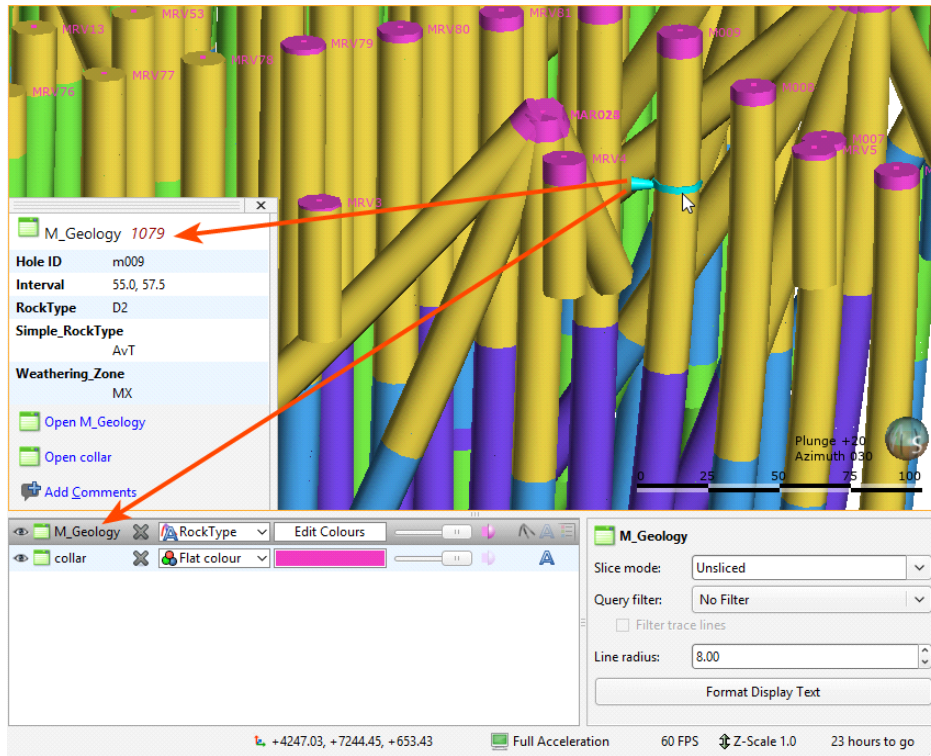

Note that clicking on an object in the scene also selects it in the shape list.

Clicking in the Shape List

When you have objects displayed in the shape list and want to locate them in the project tree, simply right-click on the object in the shape list and select **Go to Project Tree**:

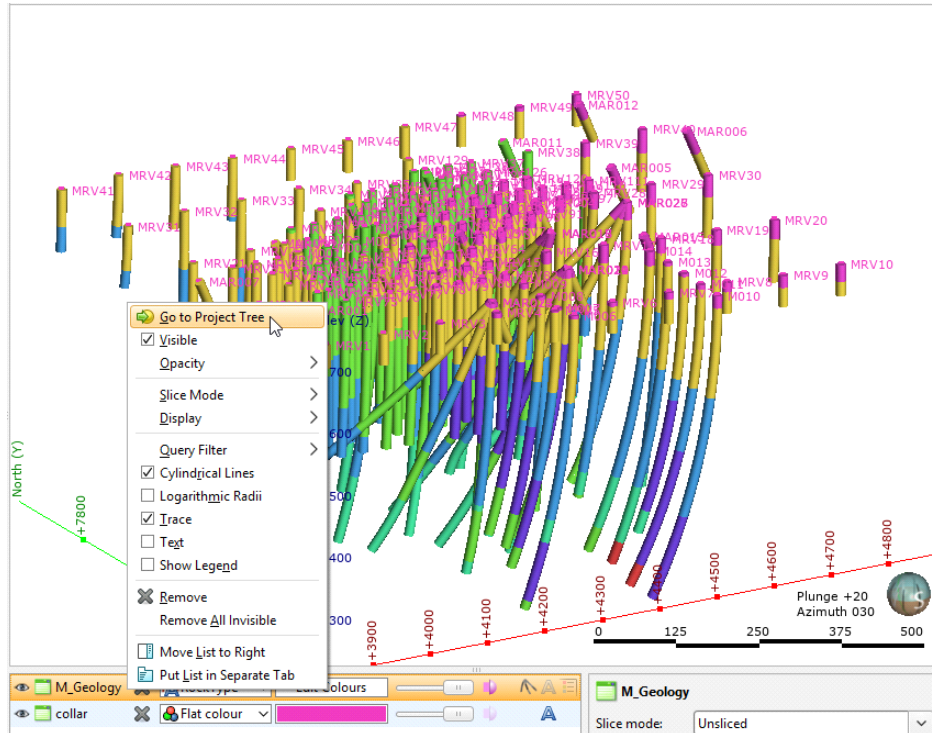

The object's location in the project tree will be expanded and the object will be selected.

Slicing Through the Data

The slicer is a powerful tool for revealing data that is concealed behind other objects and for emphasising data. Slicing can be considered a form of dynamic sectioning.

Two buttons in the toolbar can be used to add the slicer to the scene:

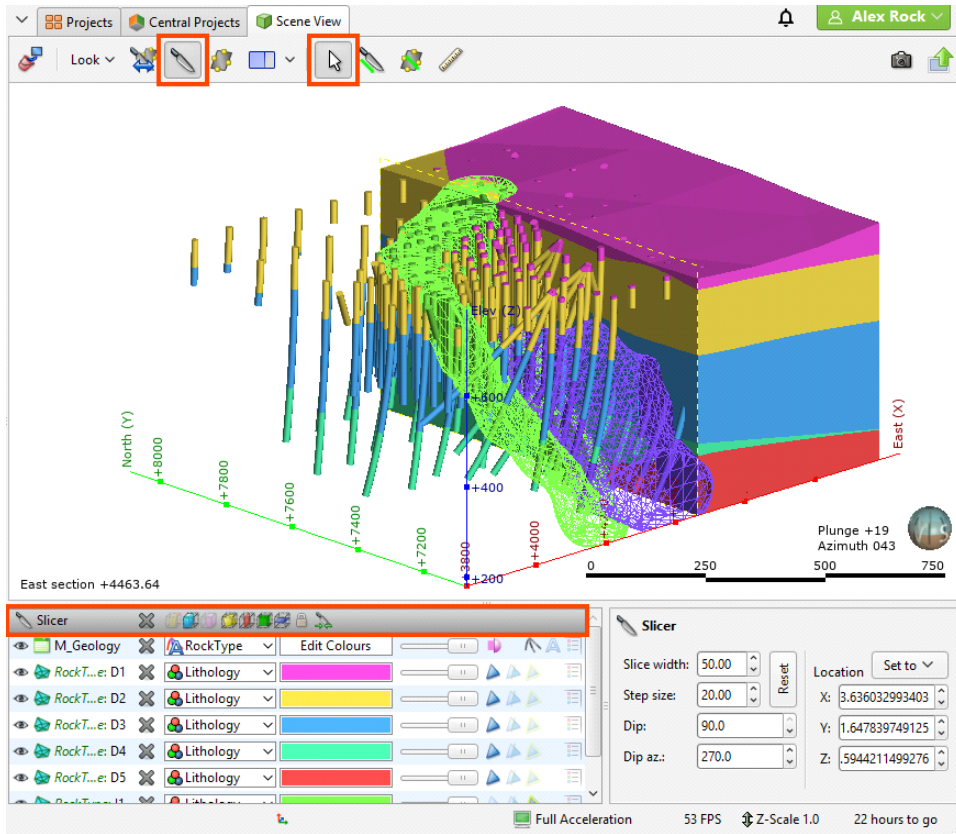

You can add the slicer to the scene by clicking the **Show slicer** button (□). The slicer will appear in the scene and you can adjust its position using the controls in the shape list:

You can also click the **Draw slicer line** button (✎), then click and drag in the scene to cut a slice through the scene.

The scene may appear empty because the slicer has removed all visible data. Reposition the slicer or turn it off.

Slicer Properties

You can change the way the slice appears in the scene using the controls in the shape list, and finer controls are available in the shape properties panel:

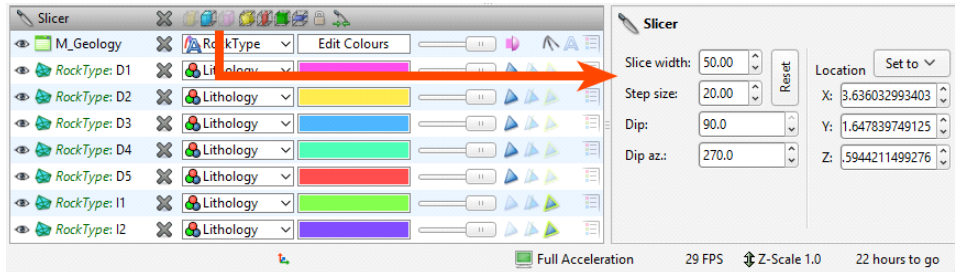

Right-click on the slicer in the shape list to view more information about each option:

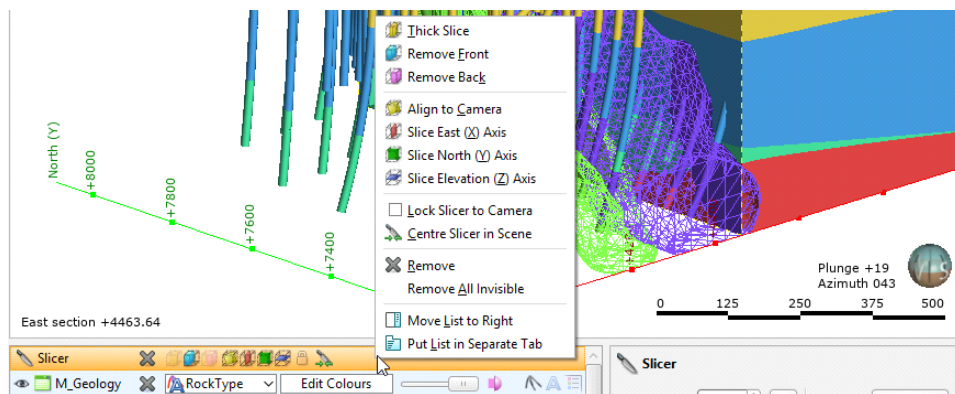

The **Lock to Camera** (🔒) option locks the slice to the current view so that moving the scene changes the direction of the slice.

These options can also be controlled from the **Look** menu:

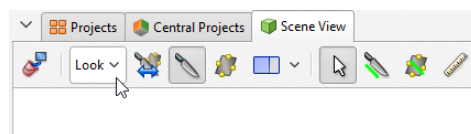

The **Set to** list in the shape properties panel contains standard views, together with any sections displayed in the scene:

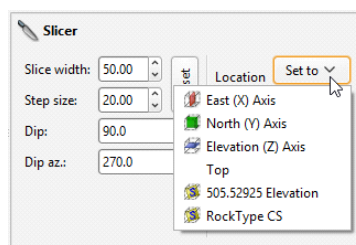

To move the slicing plane in a direction orthogonal to the slicing plane, hold down the Ctrl key and the right mouse button while dragging the mouse.

To change the thickness of a thick slice, hold down the Ctrl key and the middle mouse button while dragging the mouse. If you have a two-button mouse, hold both buttons.

Object Slice Mode

When you draw a slice in the scene, how objects in the scene are displayed in relation to the slicer is controlled in the properties panel for that object. For example, here the M_Geology table is selected in order to change how the drillholes are displayed in relation to the slicer:

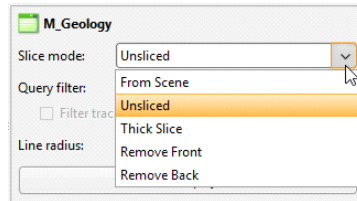

The **From Scene** setting is the default; the object is sliced according to the properties set for the slicer.



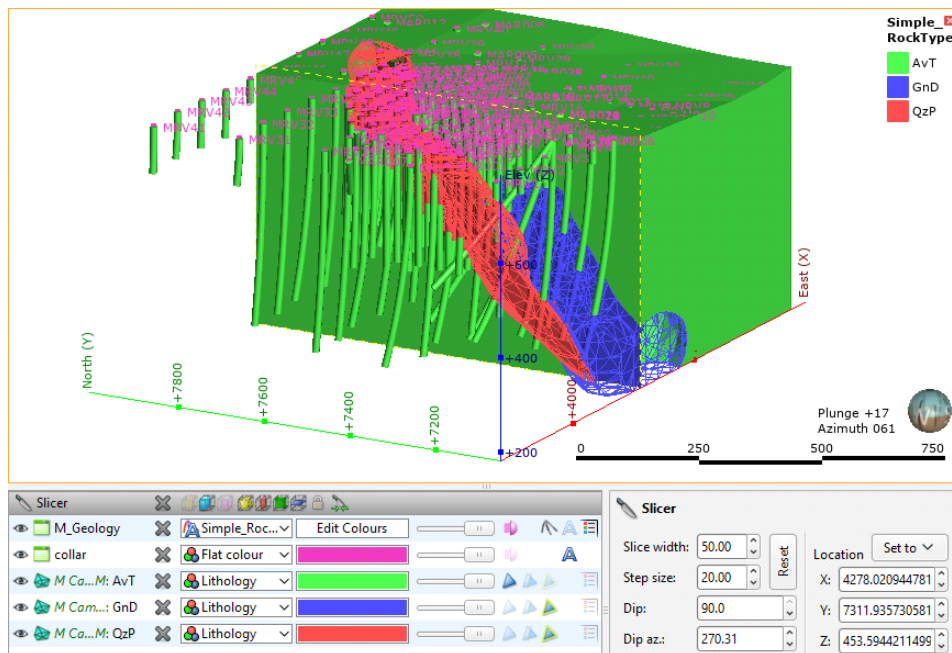



By changing the **Slice mode** for objects in the scene, you can illustrate how a model has been constructed:



Slicer Shortcuts

Use the following keyboard shortcuts to control the slicer:

Key(s)	Action
Ctrl+/-	Add the slicer to the scene. Press Ctrl+/- to remove the slicer from the scene.
L	Look at the slicing plane
Shift+L	Look at the back of the slicing plane
T	Thick slice (🔪)

Key(s)	Action
F	Remove front 
K	Remove back 
Ctrl+V	Orient the slicer to the current view
Ctrl+E	Slice the east (X) axis 
Ctrl+N	Slice the north (Y) axis 
Ctrl+D	Slice the elevation (Z) axis 
Ctrl+L	Lock the slicer to the camera 
C	Centre the slicer in the scene
Ctrl+right mouse button	Move the slicer forward and backward in the scene
Ctrl+middle (or left+right) mouse button	Change the slice width
, (comma)	Step the slicer forward
. (full stop)	Step the slicer backward

Measuring in the Scene

Leapfrog Geo has a number of tools for making quantitative measurements in the scene. These include:

- Clicking on an object in the scene. This will open a window containing more information about the object.
- Viewing an object's properties to determine its size. Right-click on the object in the project tree and select **Properties**. Information on the size of the object will be displayed in the **General** tab.
- Using the cursor to determine an approximate location in the scene. See [Determining a Location](#).
- Using the moving plane to measure trends. See [The Moving Plane](#).
- Using the ruler to measure in the scene. See [The Ruler](#).

Determining a Location

The simplest way of measuring an approximate location in the scene is to first display an object in the scene window, then position the cursor over the location. The position of the cursor is displayed at the bottom of the Leapfrog Geo window:

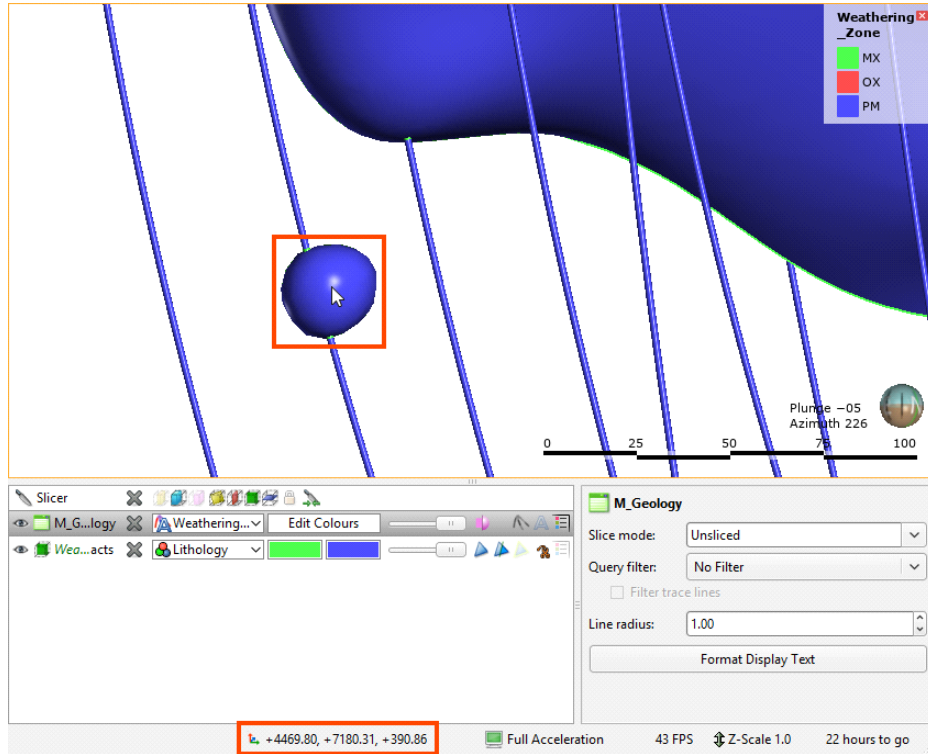

The position of the cursor in the scene is calculated using the depth buffer on the graphics card and so is not an exact method of measuring in the scene.

If you require an exact position, click on the object. Leapfrog Geo will compute the exact position of the point highlighted in the scene and display it in a pop-up window:

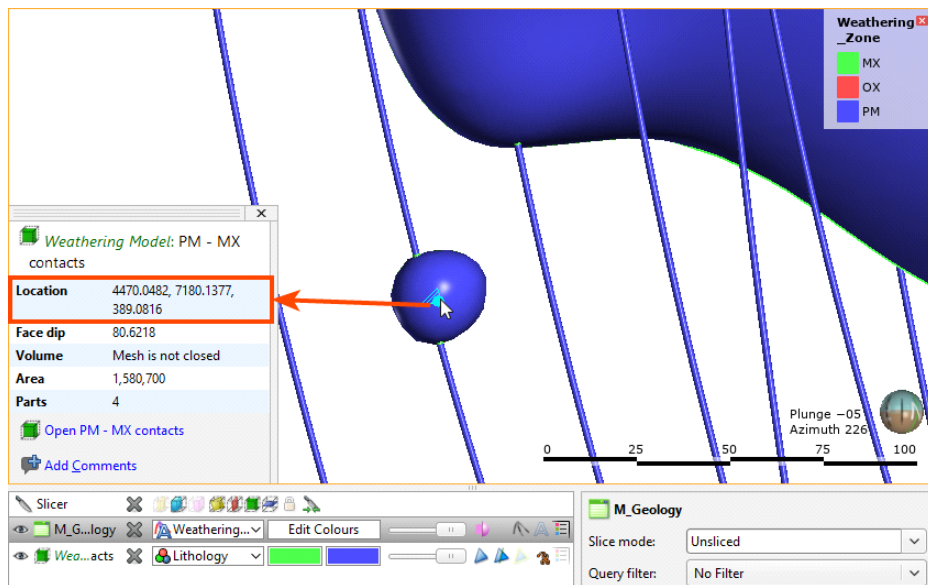

The Moving Plane

In Leapfrog Geo, the moving plane is used for measuring planar structures and defining coordinate system orientations. There are two tools in the toolbar that relate to the moving plane:

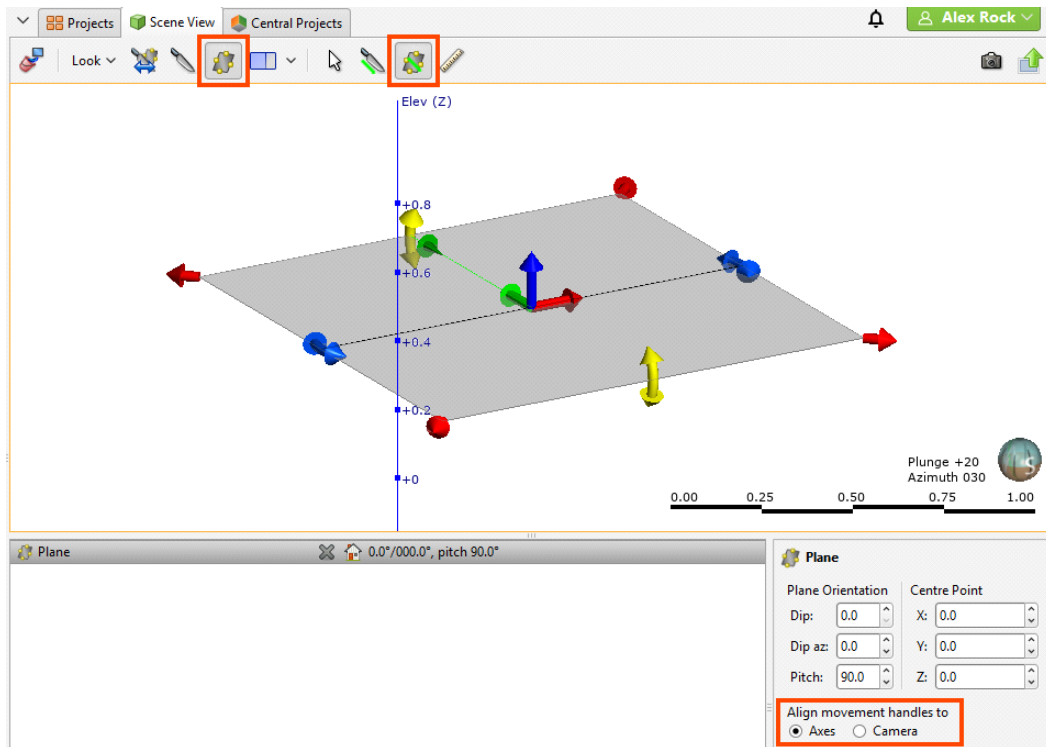

To use the moving plane, click the **Show plane** button (📐) and position the plane in the scene. The main axis of the moving plane is defined by the green line. The second axis is defined to be in the plane at right angles (orthogonal) to the main axis. Third axis is perpendicular to the plane.

There are three ways to position the plane. You can:

- Use the handles in the scene window to move the plane. If you cannot see the handles, click on the moving plane.
- Use the **Plane** controls in the shape properties panel to change the **Dip**, **Dip Azimuth**, **Pitch** and **Centre Point**.
- Orient the scene to look parallel to the required plane position, then click on the **Draw plane line** button (📐). Draw the required line in the scene.

Plane movement can be aligned to the **Axes** or to the **Camera**:

- With the **Axes** option, the handles move in cartesian coordinates. This is the only option available in older versions of Leapfrog Geo.
- With the **Camera** option, the handles move relative to the camera angle. This is the way the moving plane handles worked in Leapfrog Mining.

Drawing the plane line is usually the most convenient method of defining a planar structure.

To remove the moving plane from the scene:

- Click the **Show plane** button (🗑️).
- In the shape list, click the delete button (✖️) for the moving plane.

Use the following keyboard shortcuts to control the moving plane:

Key(s)	Action
Ctrl+;	Add the moving plane to the scene. Press Ctrl+; to remove the moving plane from the scene.
M	Look at the moving plane
Shift+M	Look at the back of the moving plane
Ctrl+M	Look down the moving plane pitch
Shift+Ctrl+M	Look up the moving plane pitch

The Ruler

You can use the ruler to measure distances in three dimensional space and between drillholes and planned drillholes.

The easiest way to use the ruler is to click on the **Ruler** button (📏) and click and drag between points in the scene to start making measurements. A ruler line will appear in the scene to indicate the measurement. Information about the distance measured will appear in the scene and in the shape properties panel:

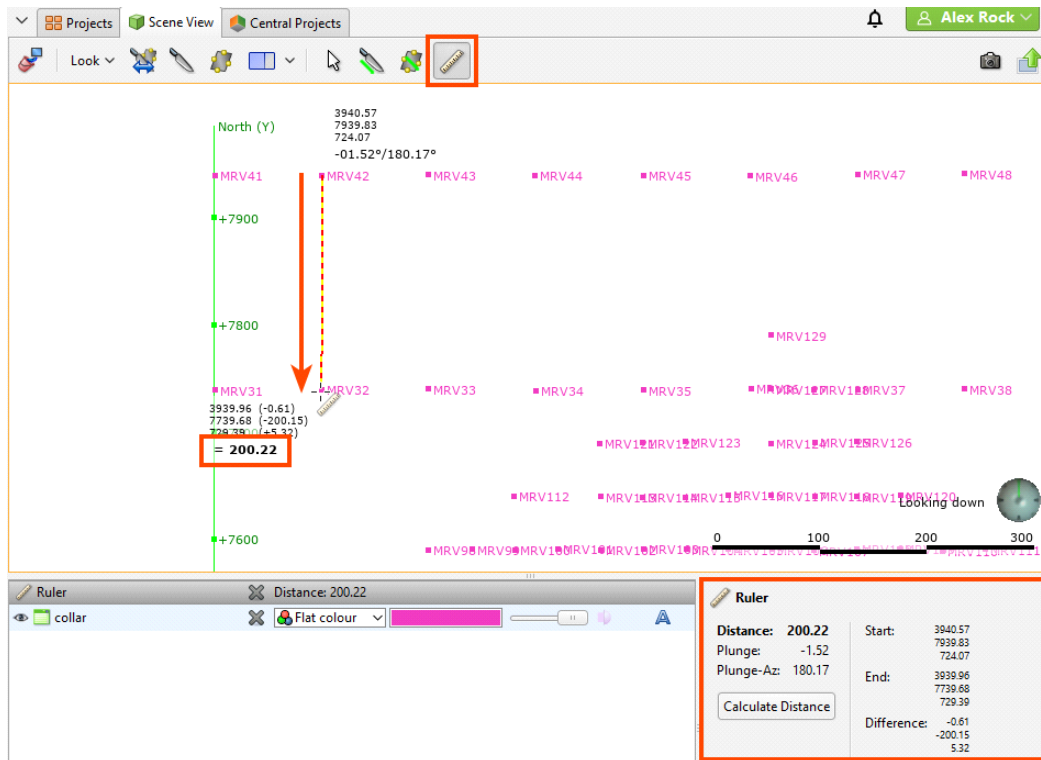

The ruler tool stays active in the scene so you can make as many measurements as required.

You can also measure the distance between drillholes or between drillholes and a point. To do this, click on the **Calculate Distance** button in the shape properties panel. The **Distance Calculator** window will appear:

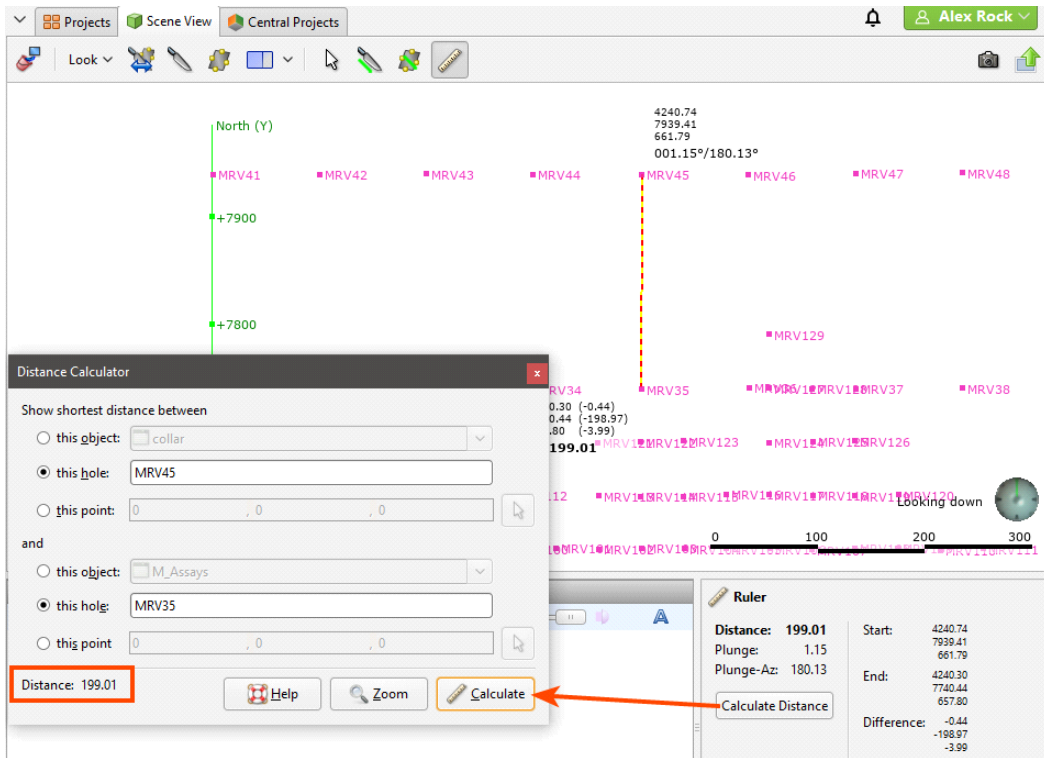

You can select both drillholes and planned drillholes. Click **Calculate** to calculate the distance and update the ruler in the scene. The distance value will appear in the **Distance Calculator** window.

You can also select a point in the scene by clicking the **Select** button (📍) in the **Distance Calculator** window, then clicking in the scene. The location of the point in the scene will appear in the **Distance Calculator** window.

After measuring a distance, it is a good idea to change the viewing angle to confirm that the measurement has been made between the correct points in three dimensions.

There are two ways to remove the ruler from the scene:

- Click the **Select** button (📍).
- Click the delete button (✖) for the ruler object in the shape list.

Working With Split Views

The **Split View** button () in the toolbar allows you to view up to two alternative views of the objects displayed in the scene:

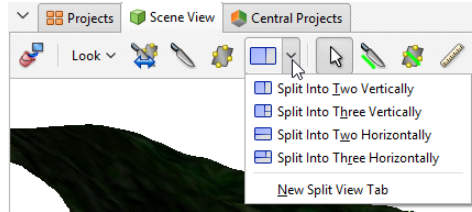

The alternative views available are a **Plan View** or a **Zoomed Out** view:

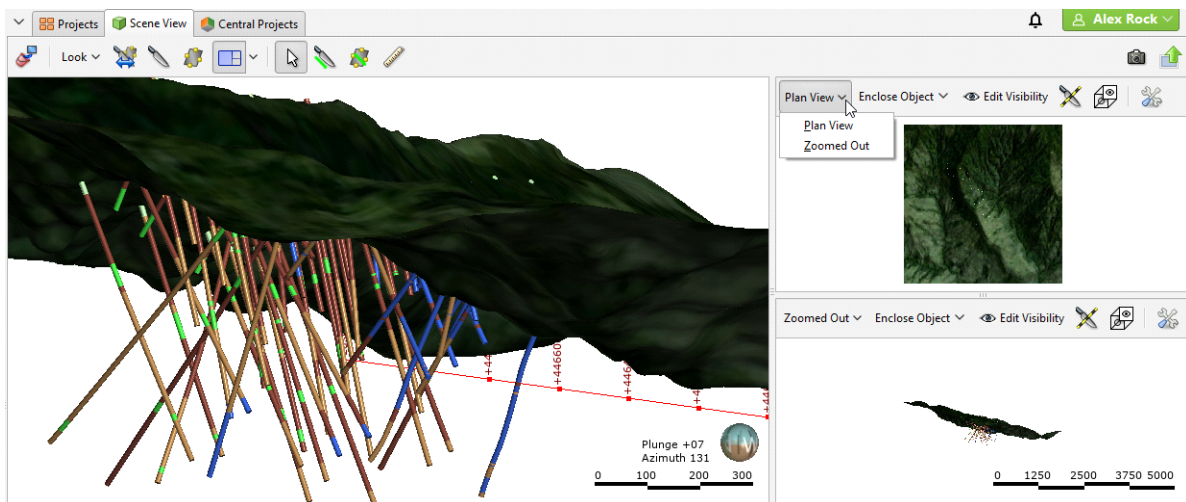

You can also open an alternative view in a new tab by choosing the **New Split View Tab** option:

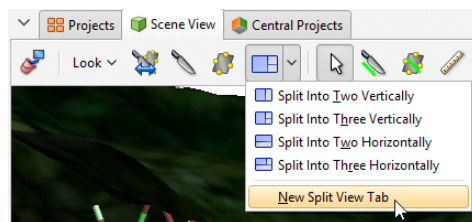

You can resize the scene and the alternative views and Leapfrog Geo will remember the position of each view when you switch to that split view again.

To return to displaying only the scene view, click the **Split View** button ()

Each alternative view has a toolbar that gives you different options for displaying the view. Use the **Enclose Object** list to zoom into or out of the alternative view:

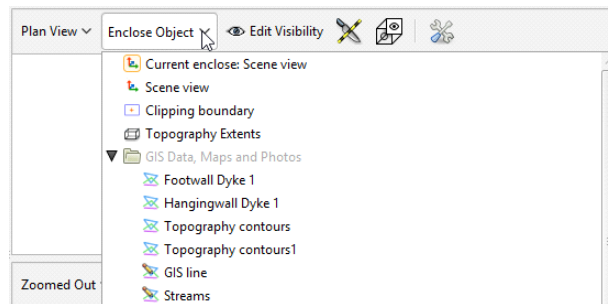

The list displayed includes all objects available in the project, plus the clipping boundary and the current scene view.

Click the **Edit Visibility** button (👁️) to change what objects from the scene view are visible in the alternative view:

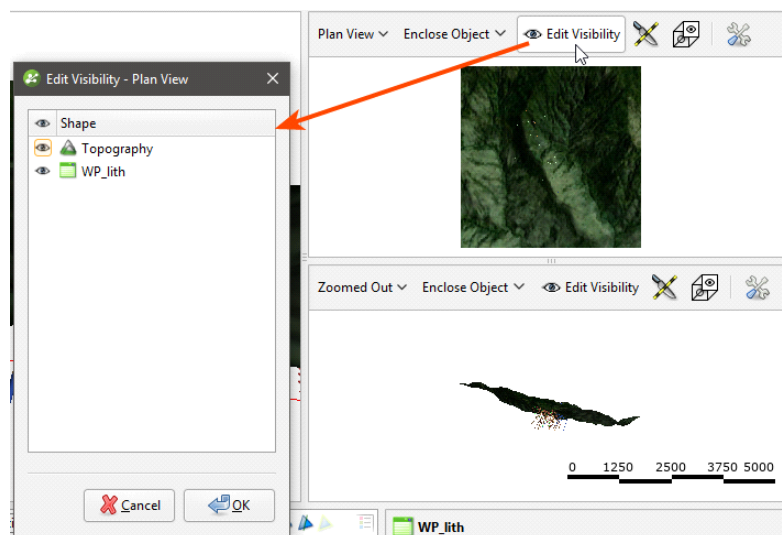

An object must be visible in the scene view's shape list for its visibility to be controllable from the alternative view's **Edit Visibility** list. What this means is that objects hidden in the scene view cannot be made visible in an alternative view.

When the slicer is in the main scene view, you can display the contents of the alternative view sliced or unsliced. Click the **View Unsliced** button (✕). The slicer, shown in blue in this image, remains displayed in the alternative views, but the view's contents are displayed unsliced:

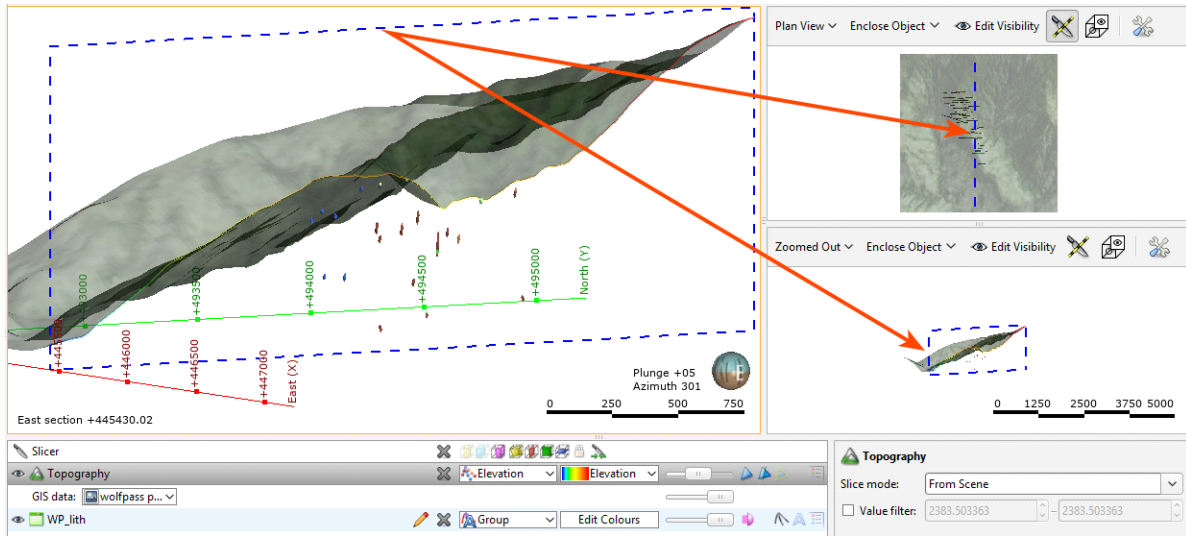

In alternative views, you can display a view window that shows what part of the alternative view is displayed in the scene view. Click the **Enable View Window** button (☞):



Each alternative view has a **Settings** button (⚙️) that lets you change what overlays are displayed for that view. The alternative view can use the scene view settings, or you can customise the display of the screen grid, axis lines and scale bar:

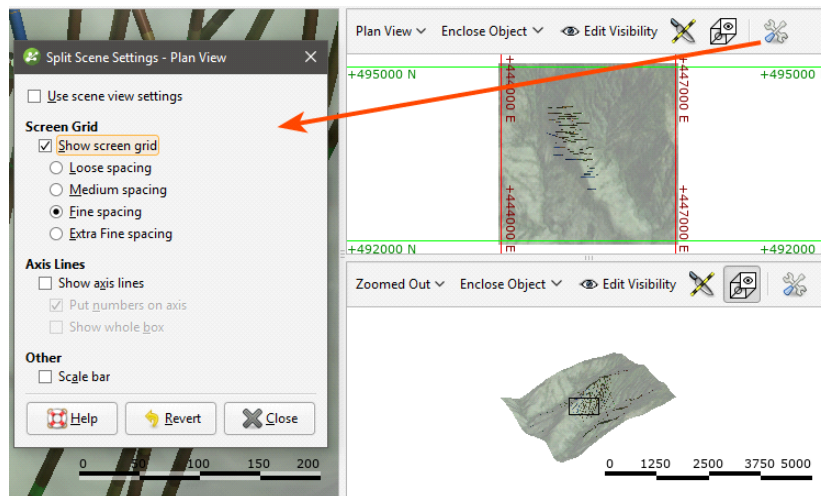

Visualising Data

Visualising data is an important part of interpreting and refining data and making modelling decisions. This topic describes the tools available for changing how data objects are displayed in the scene. It is divided into:

- [Colour Options](#)
- [Opacity](#)
- [Property Buttons](#)
- [Legends](#)
- [Slice Mode](#)
- [Filtering Data Using Queries](#)
- [Filtering Data Using Values and Categories](#)

Tools for visualising data are accessed via the shape list and the shape properties panel:

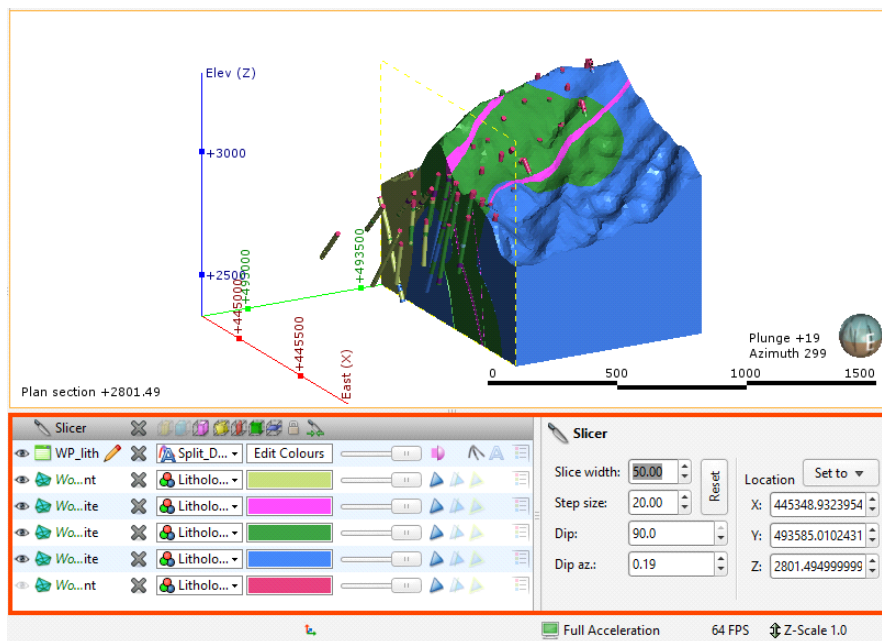

The tools available depend on the type of object being displayed.

Changing how you view objects in the scene window does not change those objects in the project tree.

The view list is available for objects that can be displayed in different ways. For example, a lithology data table may contain several columns and the column displayed can be selected from the view list:

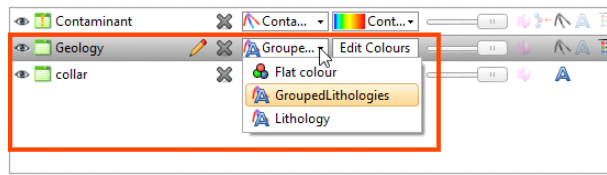

Geological and numeric model evaluations are also selected from the view list. See [Evaluations](#).

The shape properties panel adjacent to the shape list provides more detailed control of the appearance of the selected object:

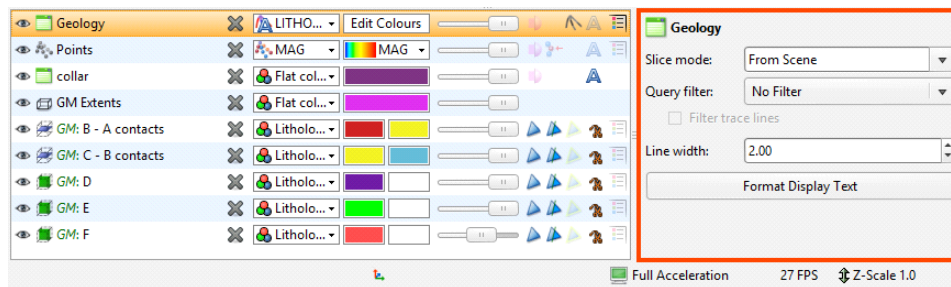

You can select multiple objects in the shape list and change their display properties using the shape properties panel. To do this, hold down the Shift or Ctrl key while clicking each object you wish to change:

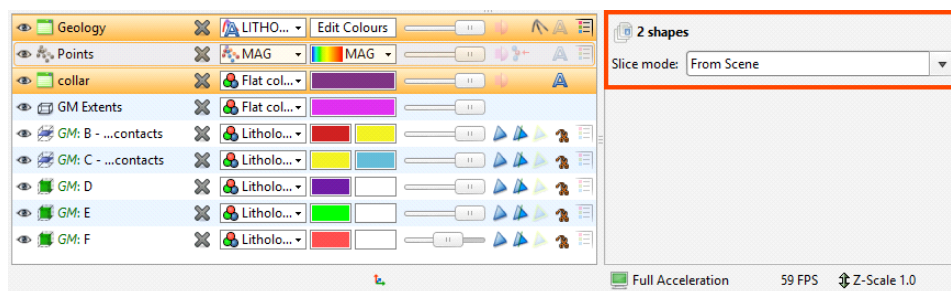

Only controls common to the selected objects are available.

Colour Options

The colour options for an object are changed in the shape list, and the options available depend on the type of object. Three different colour display options are shown below:

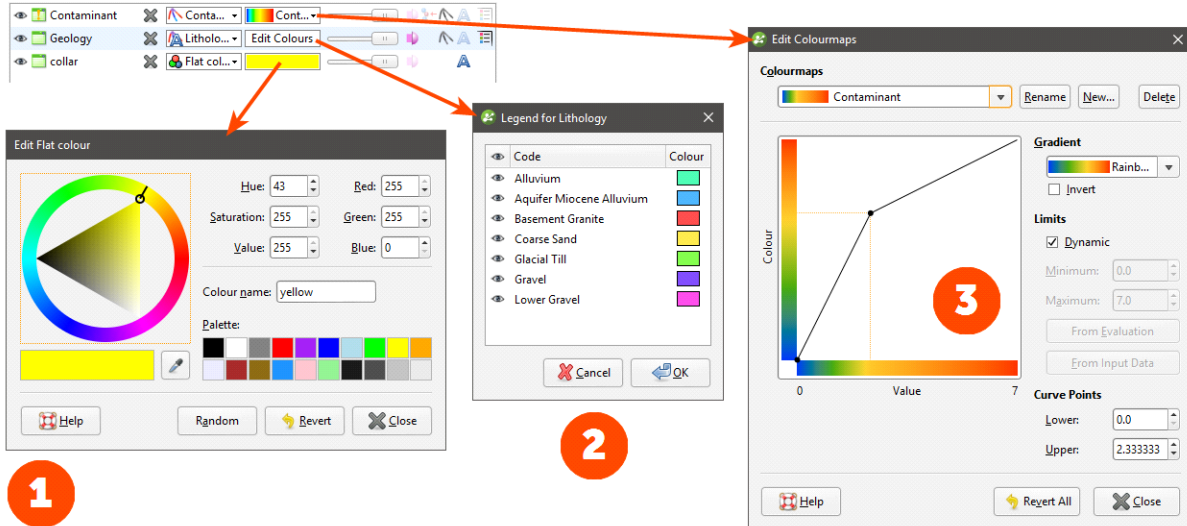

- The collar table is displayed using a single colour. Click the colour chip to change the colour. See [Single Colour Display](#).
- The Geology table is displayed according to a colourmap of the categories in the table. These colours can be changed by clicking on the **Edit Colours** button, then clicking on each colour chip in the **Legend** window.
- The Contaminant table uses a colourmap to display the numeric data. See [Colourmaps](#) for more information.

If your organisation uses standard colour coding for category and numeric data, you can import colourmaps for these data types. See [Colourmaps](#) below.

Single Colour Display

Many objects viewed in the scene are displayed using a single colour. To change the colour, add the object to the scene window, then click on the colour chip in the shape list. A window will appear in which you can change the colour:

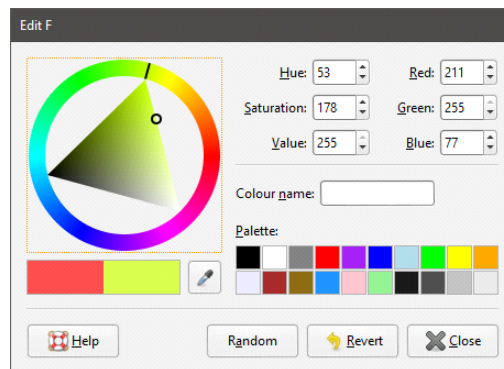

You can:

- Click and drag the ring to pick a colour, then select the darkness or lightness of the colour from the triangle.
- Click on the eyedropper tool () , then click on something elsewhere on the screen to select the colour of that part of the screen.
- Select a colour chip from the palette.
- Set a random colour.
- Enter specific values for the colour to use.

Changes made are automatically applied to the scene. The **Revert** button changes back to the colour assigned when the window was first opened.

Colourmaps

Numeric and category data are displayed using colourmaps that Leapfrog Geo automatically generates based on the data. Manually changing a colourmap often helps in understanding the data.

Colourmaps can easily be shared between projects on a column-by-column basis, which is useful if your organisation uses standard colourmaps. To import or export a colourmap, expand the data object in the project tree and right-click on a column. The **Import** and **Export** options are available from the **Colours** menu:

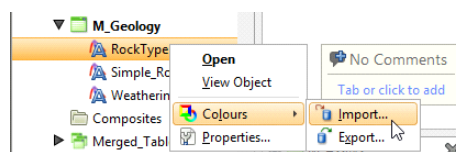

To export a colourmap, right-click on the data object and select **Colours > Export**. If more than one colourmap is associated with the selected object, you will be prompted to choose from those available. Click **Export**.

In the window that appears, navigate to the folder where you wish to save the colourmap. Enter a filename and click **Save**. The colourmap will be saved in *.lfc format.

When you import a colourmap:

- For category colourmaps, the existing colourmap will be overwritten.
- For numeric colourmaps, the imported colourmap will be added to those already defined.

To import a colourmap, right-click on the data object and select **Colours > Import**. Navigate to the folder containing the colourmap file and click **Open**.

If the object has more than one colourmap associated with it, you will be prompted to choose which one to overwrite.

If the column you expected is not listed, check to see if you have selected the correct file. The columns displayed are those that correspond to the type of data in the selected file (category or numeric).

Click **Import**.

Leapfrog Geo will map the information in the file to the information in the selected data column.

Category Colourmaps

Category data colourmaps can be edited by adding the data column to the scene, then clicking on the **Edit Colours** button in the shape list:

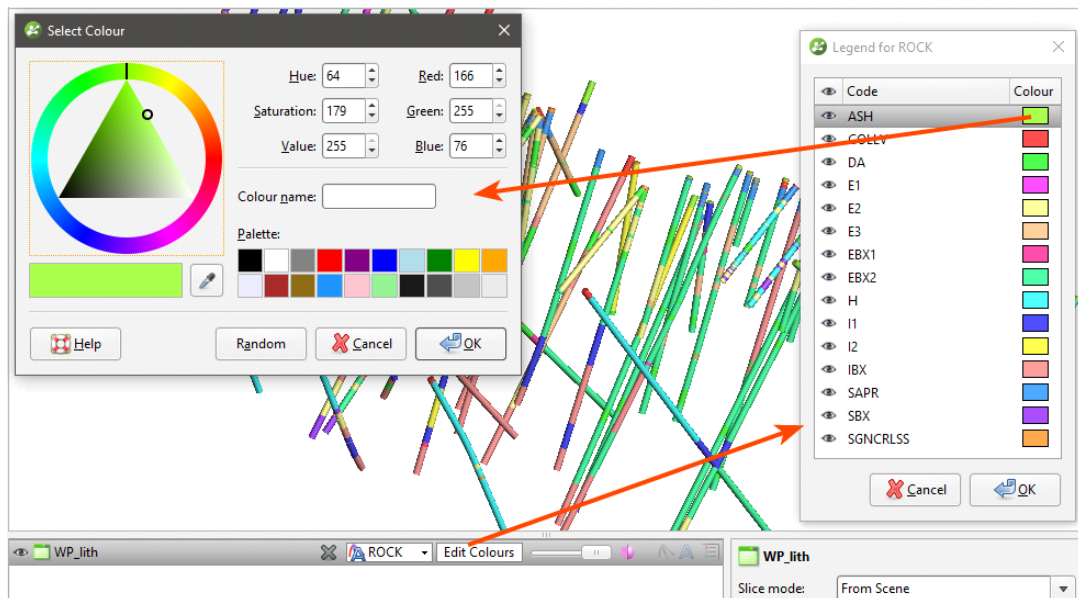

To change the colour used for a category, click on its colour chip in the **Legend** window.

Category colourmaps can also be imported and exported, as described in [Colourmaps](#) above.

Numeric Data Colourmaps

There are two types of colourmap used for displaying numeric data:

- [Continuous Colourmaps](#)
- [Discrete Colourmaps](#)

Leapfrog Geo contains a number of preset colour gradients that are used in displaying both continuous and discrete numeric colourmaps. These are:

- **Rainbow (bgyr)**. This is a perceptually uniform rainbow.
- **Rainbow (bgyrm)**. This is similar to Rainbow (bgyr), but follows red with magenta, which is common in geophysics software and RQD (geotech).
- **Viridis**. This is a good linear gradient.
- **Plasma**. This is the default colourmap for face dip.
- **Linear (gow)**. This gradient is useful for elevation data.
- **Diverging (bwr)**. This colourmap can be used when you are interested in data at either end of the spectrum.

- **Spectral.** With this colourmap, the middle is not white, and white is reserved for bins that have no data.
- **Cyclic (mygbm).** This is a good colourmap for azimuth data. Northern directions are displayed in blue and southern in yellow.
- **Grey (10-95).** This grey colourmap works well on white and black backgrounds as it doesn't start or end in white or black.

Additional colour gradients can be imported into a project in the following formats:

- Geosoft Colour Files (*.tbl)
- ERMapper Lookup Tables (*.lut)
- MapInfo Colour Files (*.clr)
- Leapfrog Colour Files (*.lfc)

Perceptually uniform colourmaps are available at <http://peterkovesi.com/projects/colourmaps/>, where they can be downloaded in ERMapper (*.lut), Geosoft (*.tbl) and Golden Software Surfer (*.clr) format.

Colourmaps used in earlier versions of Leapfrog Geo can be downloaded from http://downloads.leapfrog3d.com/Colourmaps/older_leapfrog_gradients.zip.

Matplotlib colour gradients can be downloaded from http://downloads.leapfrog3d.com/Colourmaps/matplotlib_colour_gradients.zip.

Imported colour gradients are stored in the project tree in the **Colour Gradients** folder. To import a colour gradient right-click on the **Colour Gradients** folder and select **Import Gradient**. In the window that appears, navigate to the folder containing the gradient file and click **Open**. The gradient will be added to the **Colour Gradients** folder.

If you delete a colour gradient from the **Colour Gradients** folder and it is in use in the project, you will need to select a replacement gradient for all colourmaps that use that gradient. Select the replacement colour gradient from those available in the project:

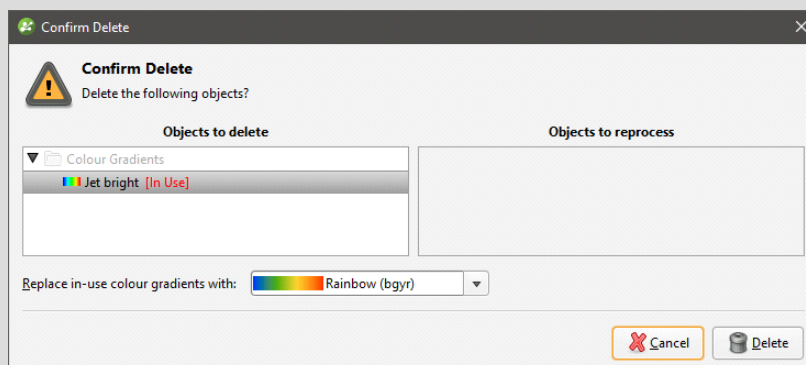

To edit the colourmap for an object, add the object to the scene. Click on the colourmap in the shape list and select **Edit Colourmaps**:

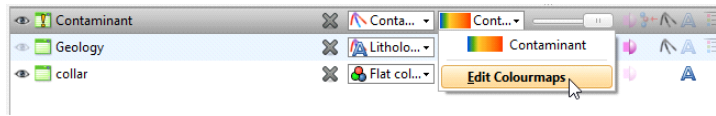

The **Edit Colourmaps** window will display the colourmap that is currently being used to display the data. The scene will be updated to reflect the changes you make in this window. To save the currently displayed colourmap and return to the main window, click **Close**.

Clicking **Revert All** deletes all custom colourmaps and cannot be undone.

Continuous Colourmaps

The **Gradient** list includes all inbuilt and imported gradients. This is the **Edit Colourmaps** window for editing continuous colourmaps, showing imported gradients from the **Colour Gradients** folder (top of the list) and the **Built-in Gradients**:

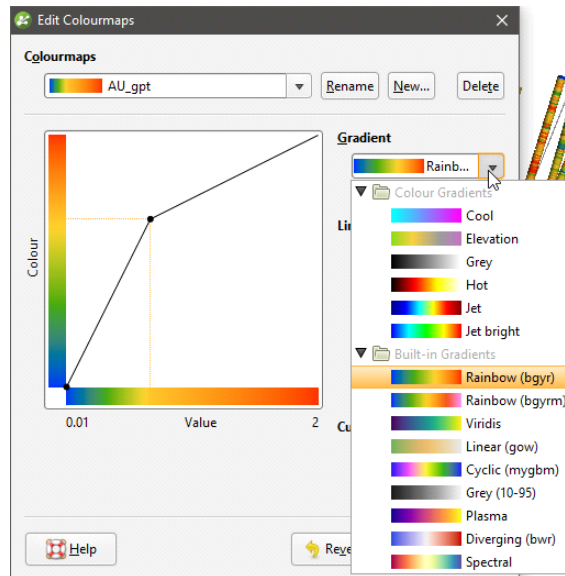

Once you have selected a gradient, you can change how it is used to display the data by adjusting the limits and the curve points.

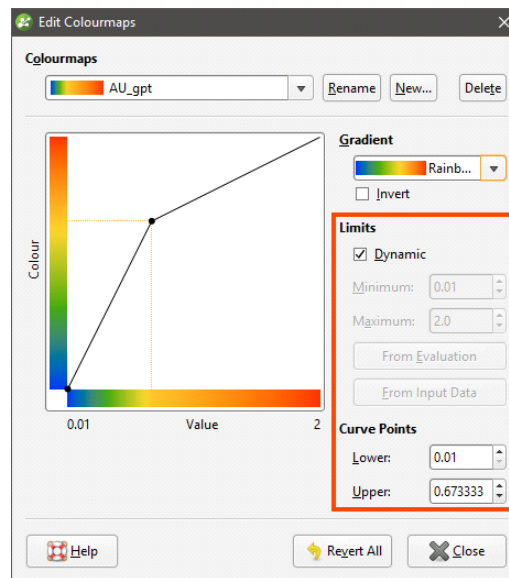

The values that lie outside the **Limits** are coloured with the last colour at the relevant end of the colourmap. If the **Dynamic** box is ticked, the gradient will be updated when the data is updated, such as when drillhole data is appended. If the box is unticked, the values manually set for the **Minimum** and **Maximum** limits will control the lower and upper bounds of the colourmap. Reducing the range of the upper and lower bounds is useful if the bulk of the data points have values in a range much smaller than the overall range of the data. This is common in skewed data.

The **From Input Data** button automatically adjusts the **Minimum** and **Maximum Limit** values so that the colourmap would follow the actual data distribution of the input data. The **From Evaluation** button appears for data columns that are part of tables produced from other data sources in the project. For example, a numeric data column that is part of a merged table will have the **From Evaluation** option. **From Input Data** uses all the data in the source data, whereas **From Evaluation** uses only the local data.

The transformation of the colourmap can be adjusted by dragging the dots:

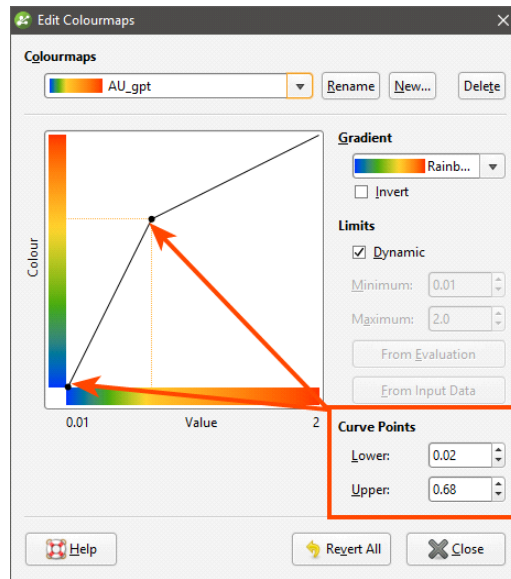

It can be helpful to view the histogram of the data when adjusting the curve points.

Both continuous and discrete colourmaps can be used to display date information. If a date is displayed using a continuous colourmap, the curve points represent the start and end dates:

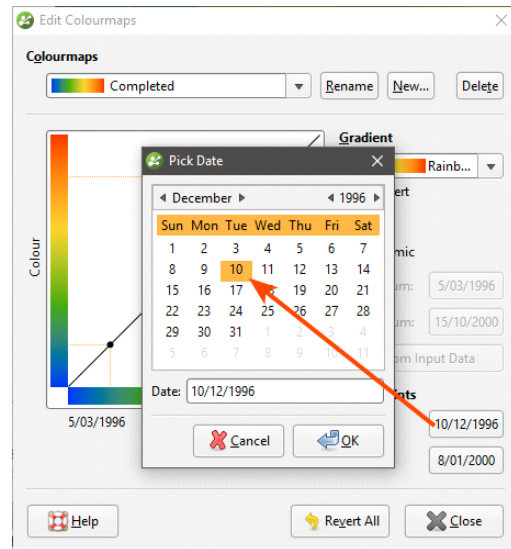

Discrete Colourmaps

With discrete colourmaps, the selected gradient can be used in generating intervals.

When you create a discrete colourmap, intervals are defined and applied to the data displayed in the scene:

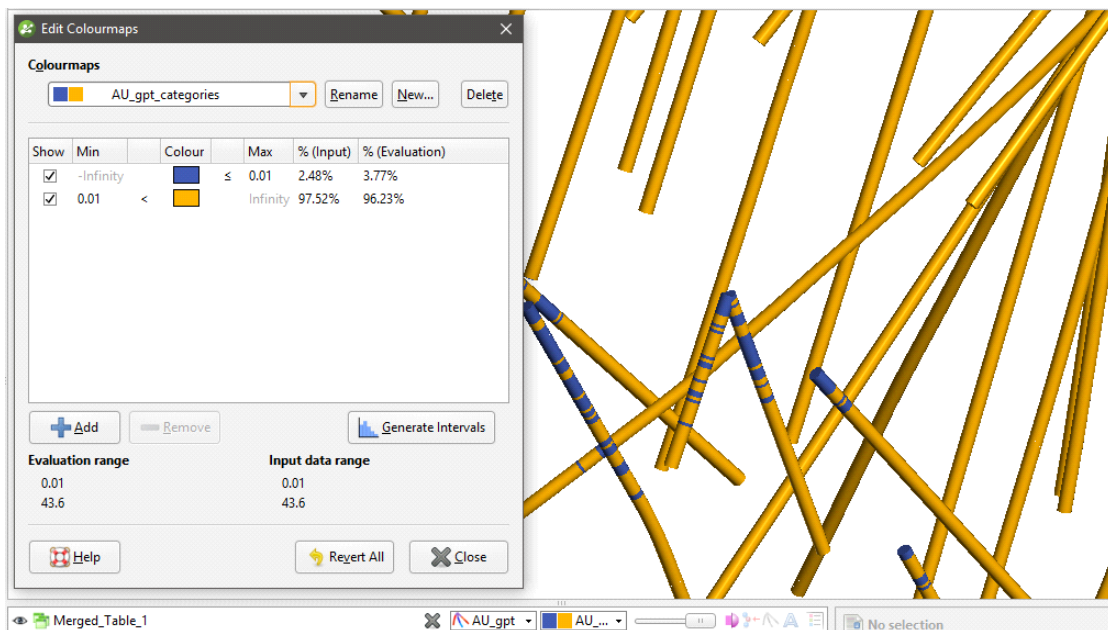

Click the **Generate Intervals** button to generate intervals based on various statistical methods:

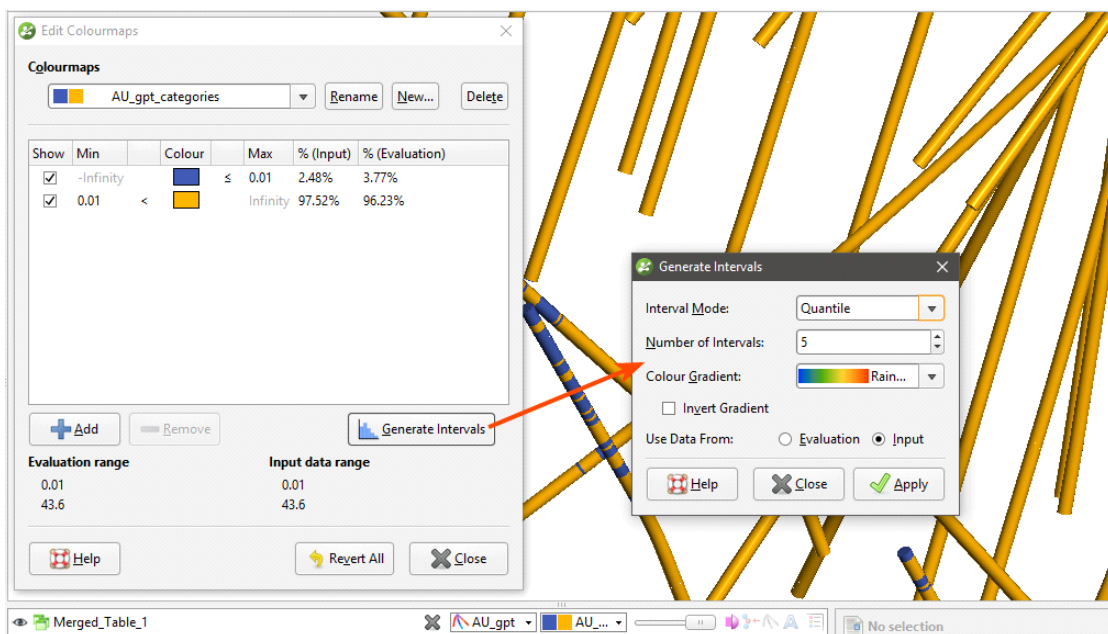

Select an **Interval Mode**. The options are:

- **Quantile**. This attempts to create the specified number of intervals so that each interval contains the same number of values.
- **Progressive**. This attempts to create intervals that enclose progressively smaller percentages of values. For example, 1000 unique values organised into 5 intervals would have the following percentiles: ~33%, ~27%, ~20%, ~13%, ~6%.

- **Progressive Double.** This is similar to **Progressive**, but is “steeper”. For example, 1000 values organised into 5 intervals would have the following percentiles: ~50%, ~25%, ~12.5%, ~6.25%, ~3%.
- **Equal Intervals.** This creates intervals at equal spacing across the range of the values.
- **Logarithmic Intervals.** This creates intervals at equal spacing, in log-space, across the range of values.
- **K Means Clustering.** This is an iterative algorithm that sorts values into clusters in which each value belongs to the cluster with the nearest mean. This option can take some time, especially with large datasets and a large number of intervals.

Set the **Number of Intervals** and the **Colour Gradient** to be used as the basis for the interval colourings.

The data used can be the **Input** data or the **Evaluation** data. The **Evaluation** option only appears for data columns that are part of tables produced from other data sources in the project. For example, a numeric data column that is part of a merged table will have the **Evaluation** option. The **Input** option uses all the data in the source data, whereas the **Evaluation** option uses only the local data.

The first interval is assigned the first colour of the selected colour gradient and the last interval is assigned the gradient’s last colour; selecting **Invert Gradient** swaps this around. Remaining intervals are assigned equally along the gradient.

Experiment with the different settings and click **Apply** to see the effects of changes:

The screenshot displays the 'Edit Colourmaps' interface. At the top, there's a 'Colourmaps' section with a dropdown menu showing 'AU_gpt_categories' and buttons for 'Rename', 'New...', and 'Delete'. Below this is a table with the following data:

Show	Min	Colour	Max	% (Input)	% (Evaluation)
<input checked="" type="checkbox"/>	-Infinity	Blue	≤ 0.19	20.18%	21.29%
<input checked="" type="checkbox"/>	0.19	Green	≤ 0.4	20.68%	19.97%
<input checked="" type="checkbox"/>	0.4	Yellow	≤ 0.64	19.71%	19.31%
<input checked="" type="checkbox"/>	0.64	Orange	≤ 1.16	19.73%	19.60%
<input checked="" type="checkbox"/>	1.16	Red	Infinity	19.71%	19.82%

The 'Generate Intervals' dialog is open, showing 'Interval Mode' set to 'Quantile', 'Number of Intervals' set to 5, 'Colour Gradient' set to 'Rain...', and 'Use Data From' set to 'Input'. The 'Apply' button is highlighted with an orange arrow.

You can also add intervals manually by clicking the **Add** button. For example, if you create a discrete colourmap to show the different stages of a drilling campaign, the initial colourmap contains only two intervals:

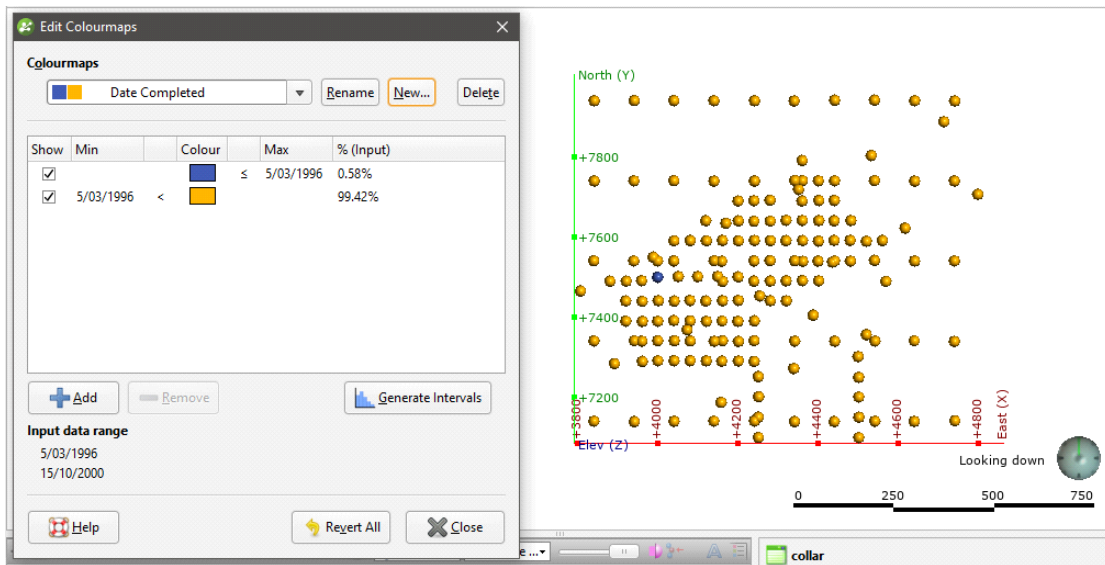

Click the **Add** button to add new intervals and use the **Min** and **Max** entries in the table to set the start and end points of each interval:

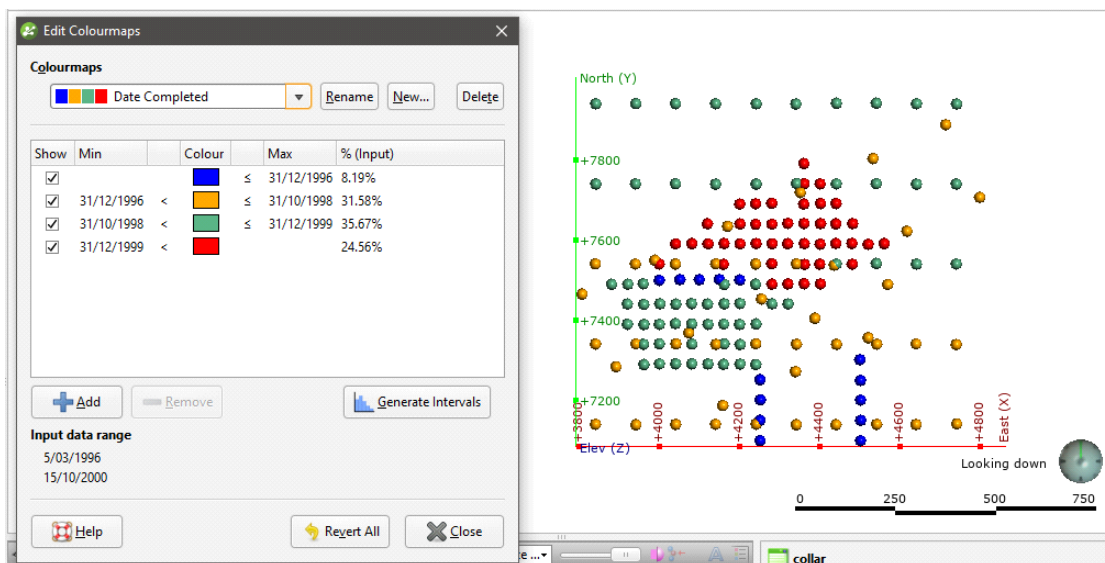

Opacity

The opacity slider in the shape list controls the transparency of objects in the scene:

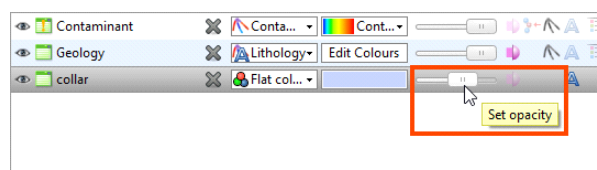

Property Buttons

The property buttons available in the shape list vary according to the type of object selected. For example, property buttons can show or hide the triangles on a mesh, render points as spheres or display a surface clipped to a model boundary. You can always find out what a button does by holding the cursor over the button:



Legends

You can display a legend for many objects, including lithologies. To do this, click the legend button in the shape list:



To remove the legend from the scene, either click the legend button again or click the red X in the scene window:



Slice Mode

When an object is selected in the shape list, a **Slice mode** property is available in the properties panel. See [Object Slice Mode](#) for more information.

Filtering Data Using Queries

When a data table is selected in the shape list, you can use the controls in the shape properties panel to apply filters to the data in the scene. If query filters are available for the selected object, they will be listed in the **Query filter** list:

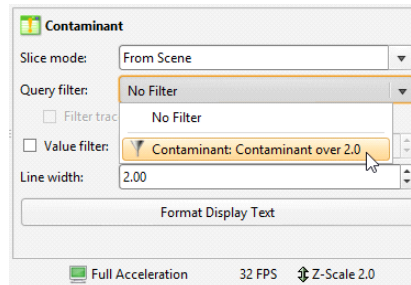

Filtering Data Using Values and Categories

In the shape properties panel, you can also filter the range of values displayed. Tick the **Value filter** box, then set the upper and lower limits of the range of data displayed:

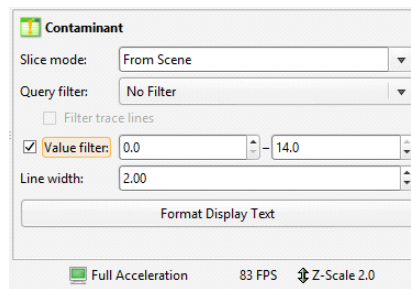

If the data includes date information, you can use the **Value filter** option to restrict the display to a range of dates.

Drawing in the Scene

In Leapfrog Geo, you can draw polylines to define many surfaces, including lateral extents and contact surfaces. You can also use polylines to make adjustments to surfaces and create new GIS lines.

This topic describes drawing polylines in Leapfrog Geo. It is divided into:

- [The Drawing Toolbar](#)
- [Drawing Hotkeys](#)
- [Drawing 3D Lines](#)
- [Drawing 2D Lines](#)
- [Polyline Properties](#)
- [Tangents and Ribbons](#)
- [Drawing Points](#)
- [Editing Normals](#)

For information on importing and exporting polylines, see [Polylines](#).

When drawing in Leapfrog Geo, you can draw on surfaces or on the slicer.

- If you are drawing on surfaces, the line will be in 3D.
- If you are drawing on the slicer, the line will be in 2D and locked to the plane it was drawn in. It can be converted to a 3D line.

When you start drawing a polyline, drawing tools are added to the scene window. If you are drawing a GIS line or if the slicer was already in the scene, the drawing mode will be set to be on the slicer. Toggle between the two options using the toolbar buttons:

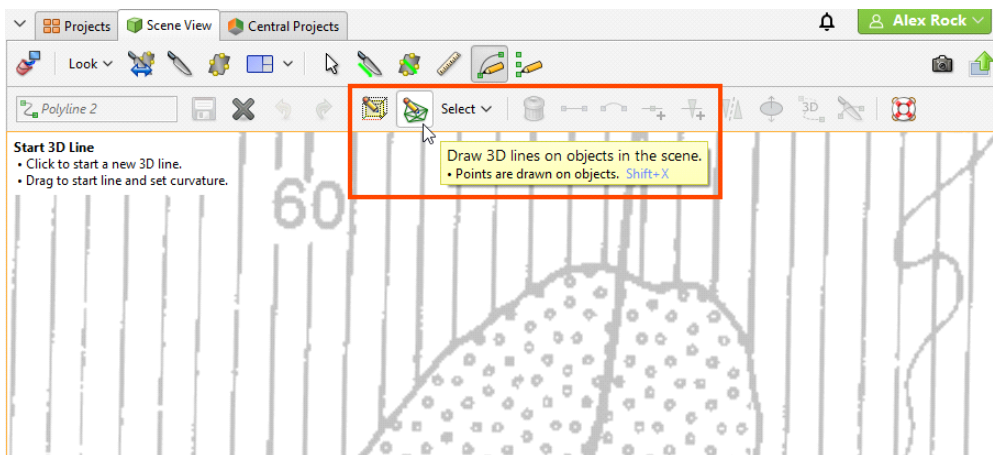

When drawing and otherwise working with the polyline, tooltips are displayed in the scene that show what actions are currently possible:

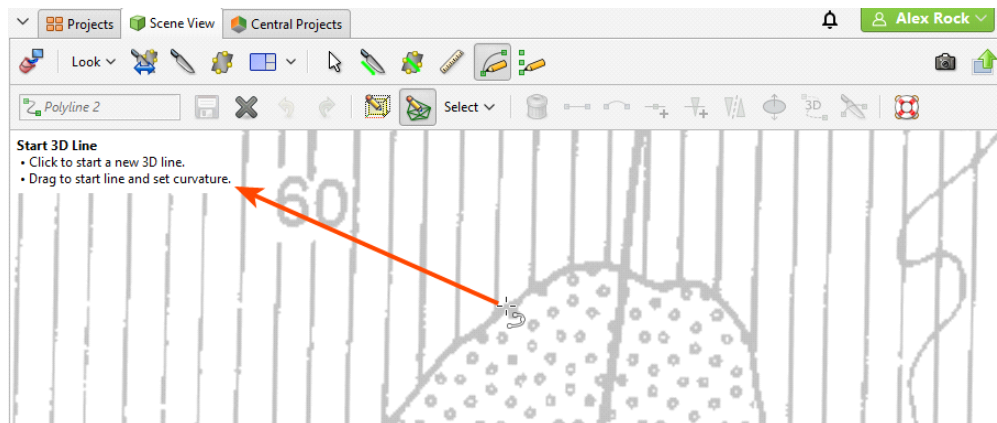

For example, if the drawing mode is set to on slicer (🔲), you will be warned if the slicer is not in the scene:

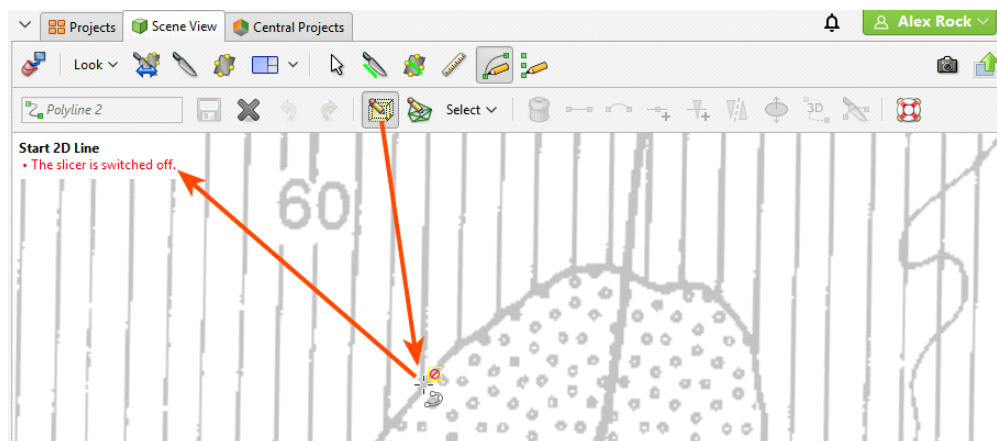

You can disable these tooltips once you are more familiar with how the polyline tool works. Open the **Settings** window by clicking on the **Leapfrog Geo** menu and selecting **Settings**. Click on **Overlays** and disable the **Polyline help text** option.

The Drawing Toolbar

The **Draw lines** (🖋️) and **Draw points** (📍) tools are used to create new lines and points. The tools in the second row are for controlling whether the polyline is drawn (on the slicer (🔲) or on surfaces (🌐)). The **Select** list lets you select different parts of the polyline.

The other tools are for working with selected parts of the polyline:

- Making line segments straight (📏) or curved (📐)
- Adding nodes (📍) to lines
- Adding tangents to lines or reorienting selected tangents (📐)
- Flipping selected tangents and disks (🔄)

- Add disks to points (📍)
- Converting a 2D polyline to 3D (📏)
- Setting the slicer to a 2D polyline (🔪)

There are also buttons for undoing (↶) and redoing actions (↷), as well as saving the polyline (💾) or deleting selected parts of it (🗑️).

Drawing Hotkeys

Use the following keyboard shortcuts while drawing:

Key(s)	Action
Ctrl+5	Draw lines (📏)
Ctrl+6	Draw points/disks (📍)
Ctrl+S	Save (💾)
Ctrl+W	Close editor (✖)
Ctrl+Z	Undo (↶)
Ctrl+Y	Redo (↷)
Delete	Delete the selected segment, node, tangent or disk (🗑️)
X	Draw/move on slicer (🔪)
Shift+X	Draw/move on objects (📏)
Q	Make segments curved (↩)
Shift+Q	Make segments straight (↪)
Shift-A	Add node (📍)
A	Add/reorient tangent (📏)
V	Flip tangent/disks (📏)
Shift+D	Add/remove disk (📍)
Shift+E	Make selected line 3D (📏)
Shift+W	Set slicer to selected 2D line (🔪)
Ctrl+A	Select all
Shift+Ctrl+Alt+L	Select all lines
Shift+Ctrl+Alt+T	Select all tangents
Shift+Ctrl+Alt+P	Select all points without disks
Shift+Ctrl+Alt+D	Select all points with disks

Drawing 3D Lines

Polylines are made up of nodes, which are added where you click in the scene using the **Draw lines** (🎨) tool. This is a 3D polyline, which is indicated in the scene by the dashed line:

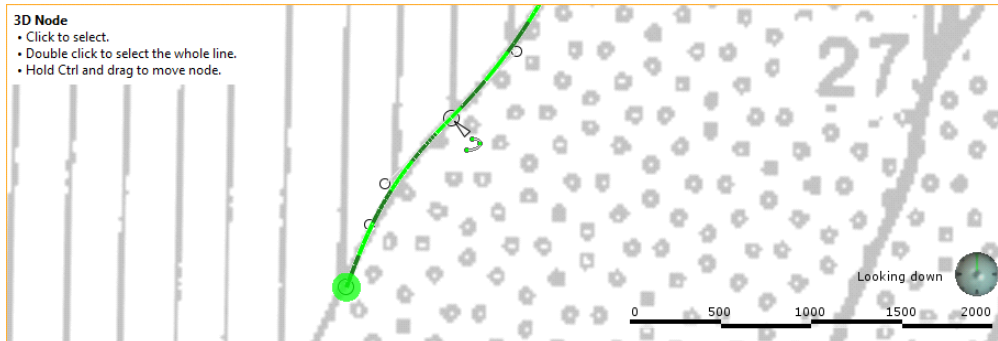

Click to select a node and drag to move it in the scene parallel to the screen. If you hold down the Ctrl key while moving the node, it will snap onto surfaces in the scene.

When drillhole segments are in the scene, the polyline tool will snap to the end of nearby intervals.

When you click to add a node, dragging the mouse before releasing the button lets you control the curvature:

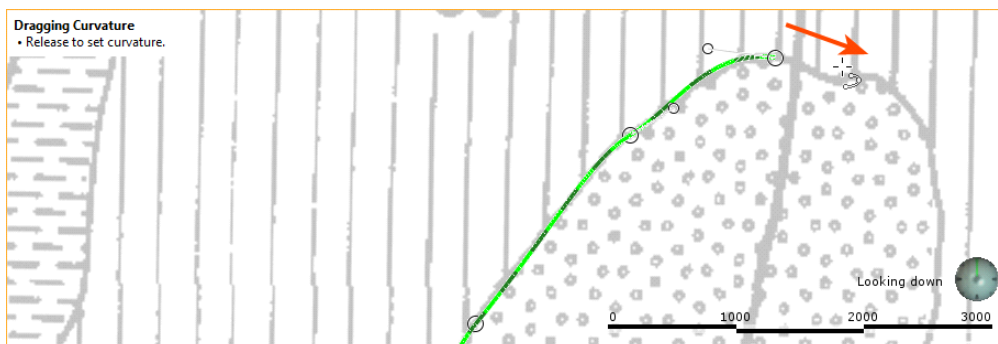

When you start drawing a polyline, a tangent is automatically added to the first node. This is oriented in the direction of the camera, and you will need to rotate the scene to see that it is a cone.

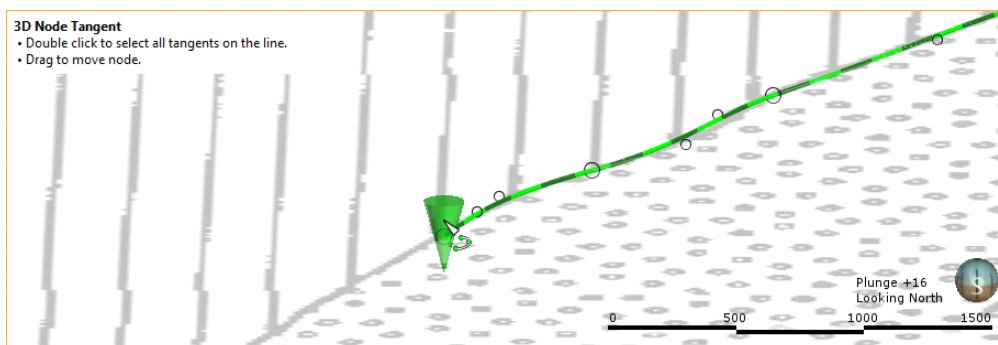

You can hide the tangent cones in the scene, if it makes drawing difficult. To do this, click on the polyline in the shape list and disable the **Show tangent cones** option:

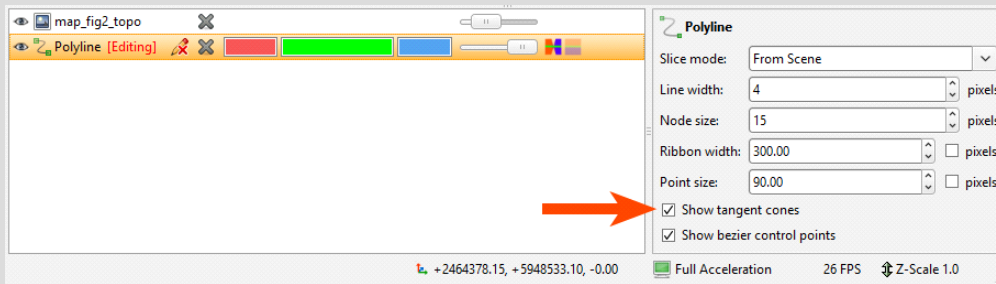

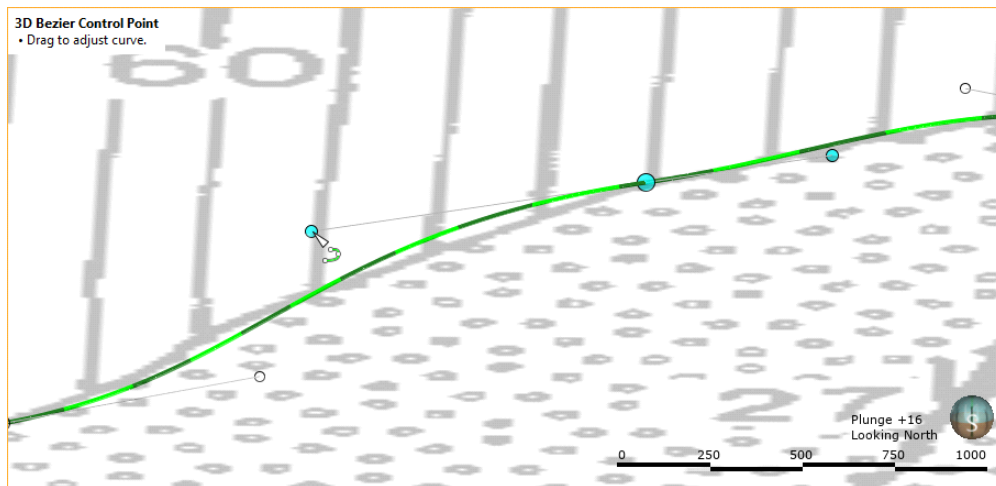

There are also bezier control points for curved segments. Bezier control points are used to control the curvature of the segment. Click on a control point and drag it to change the curve of the segment:

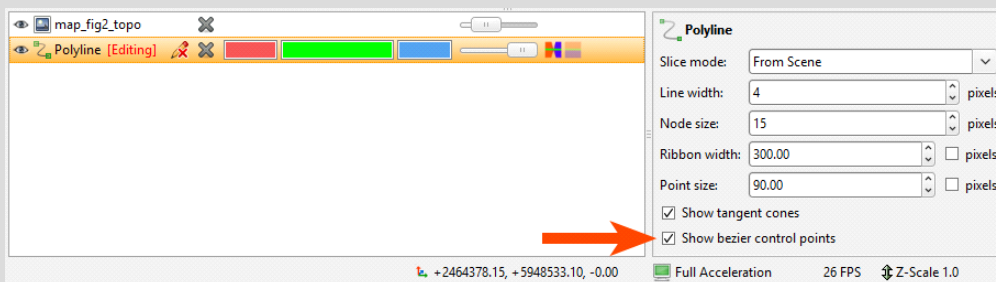

If you can't see the bezier control points, click on the polyline in the shape list and enable the **Show bezier control points** option:



When you have finished drawing, right-click to end the polyline. Switch to the **Select** tool () to make changes to the polyline.

- Click on a node to move it.
- Click on a segment away from a node and drag it to change its curvature.
- Click on one or more segments, then make them straight () or curved (.

- Select a point on the polyline, then click (📍) to add a node.
- Select a point on the polyline. The point selected is indicated in the scene by a red cone. You can then click (📍) to add a tangent oriented in the direction of the camera.
- Select a tangent and click (📍) to change the orientation of the segment to that of the camera.
- Select a tangent and click (📍) to flip it.

Begin drawing again by selecting the **Draw lines** button (🖌️). To continue from an existing node at the start or end of a polyline, click on the node.

Although you can make the line curved while adding nodes, an easy way to draw a curved polyline is to simply click to add a series of points. Set the curvature of the whole line by selecting all segments and then clicking the **Make selected segments curved** button (📐):

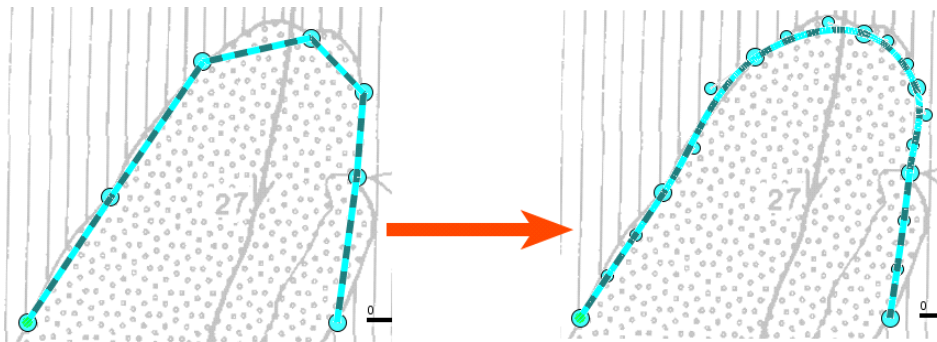

You can then make any adjustments to the curves required by dragging the segments or using the bezier control points.

Drawing 2D Lines

Working with a 2D polyline is similar to working with a 3D polyline, except that drawing is restricted to the 2D plane set by the slicer. A 2D polyline is indicated in the scene by an unbroken line:

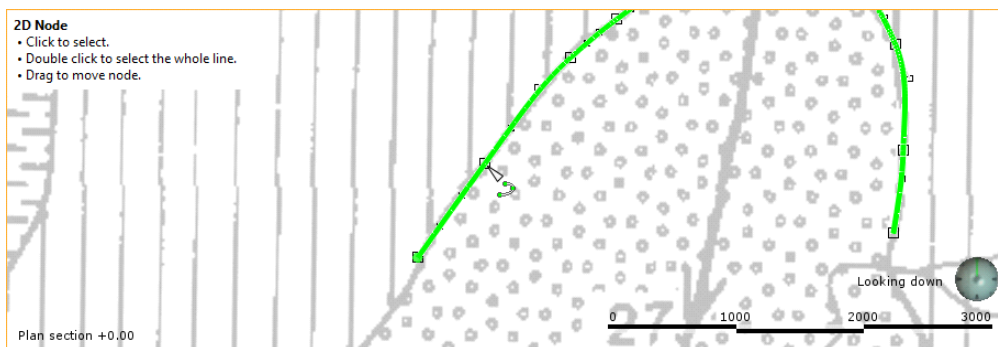

To convert a 2D polyline into a 3D polyline, click the 3D polyline button (📍).

Polyline Properties

In the shape list, you can control the colour of the positive (red) and negative (blue) surfaces of the line and of the line itself (green):

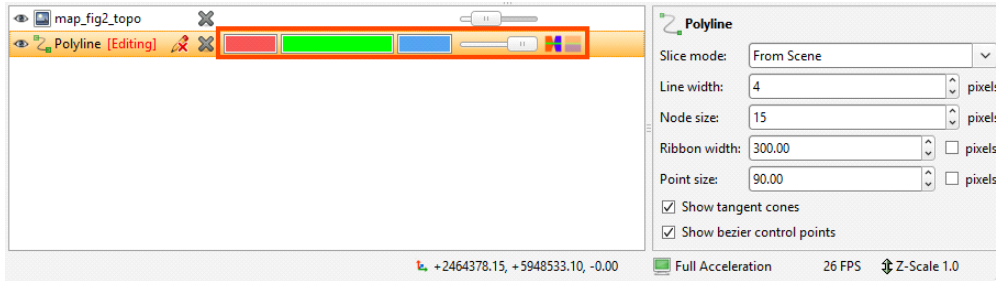

For contact surfaces, the colour of the positive and negative sides of a ribbon will be determined by the lithologies or categories assigned to either side of the surface.

With the controls in the properties panel, you can change the size of different parts of the polyline to make working with the polyline easier.

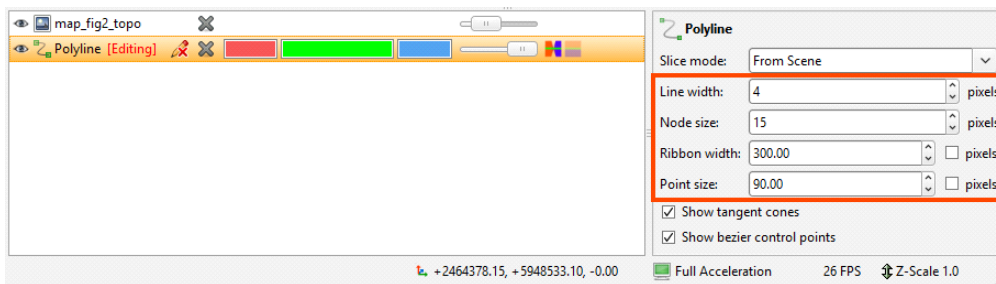

For **Ribbon width** and **Point size**, the setting is, by default, in pixels, but both can be displayed in real-world size, which may make editing the polyline easier in some circumstances.

You can also choose whether or not to show tangent cones and bezier control points.

Tangents and Ribbons

The **Surface ribbon** (🚩) and **Normal ribbon** (🚩) help you to determine the orientation of the polyline in the scene. The surface ribbon reflects the orientation of the polyline and the normal ribbon is perpendicular to the surface ribbon.

For example, click on the **Surface ribbon** button (🌈) to determine which side of the polyline is positive (red) and which side is negative (blue):

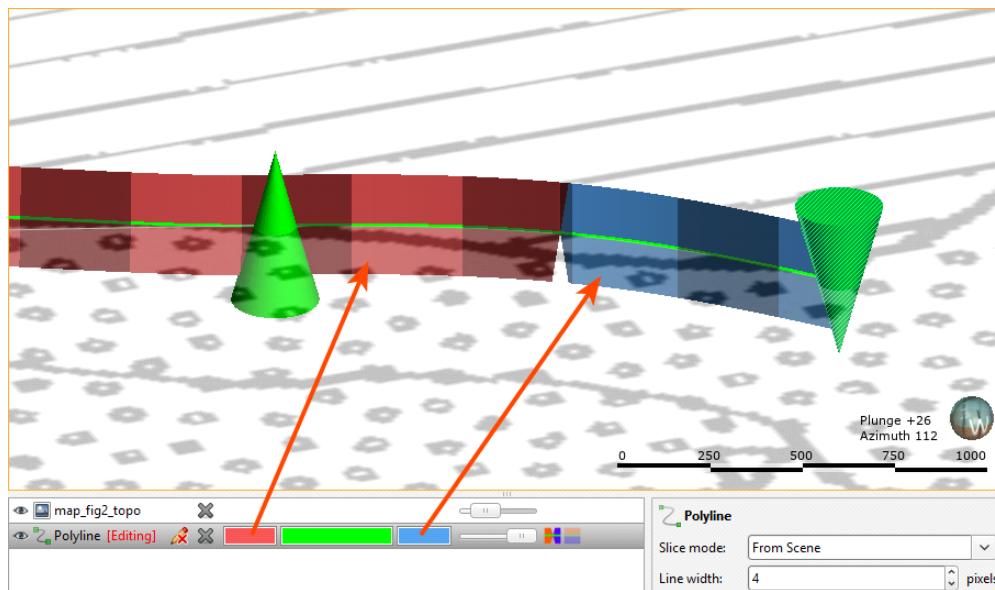

If you are having trouble seeing the ribbons, you can change their size using the **Ribbon width** control in the properties panel.

When you first draw a polyline, it has only one tangent, located at the first node and oriented in the direction of the camera. You can add more nodes by clicking at a point along the polyline and then clicking the **Tangent** button (📐). A tangent is added to the polyline, which is updated to reflect the new information. The tangent's orientation is taken from the camera angle. To reorient a tangent, click on it in the scene, change the camera angle to reflect the orientation you wish to set, then click the **Tangent** button (📐).

You can also flip selected tangents by clicking on the **Flip tangents and disks** button (🔄).

You can add as many tangents as required, although it is best to keep them to a minimum.

Drawing Points

Polylines can also include points, which are drawn using the **Draw points** tool (📍). Clicking adds a point, and clicking and dragging adds a point with a normal:

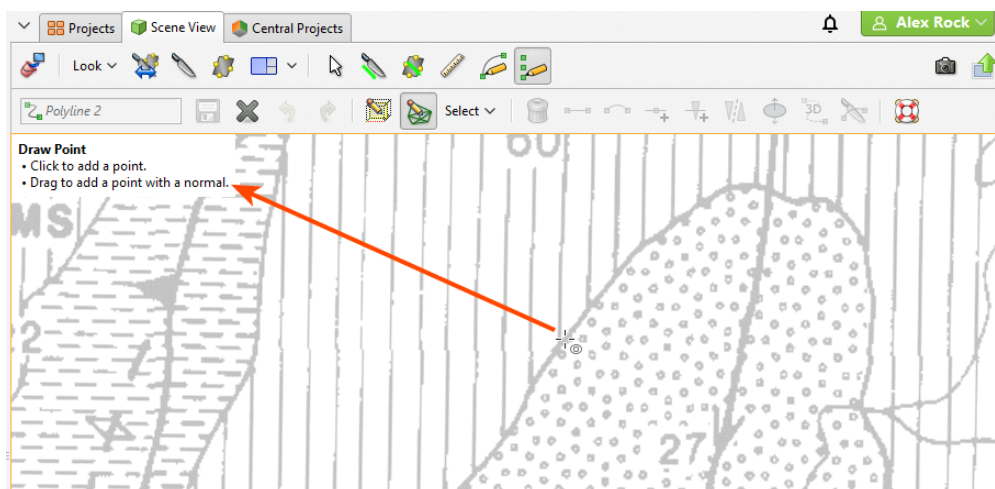

Normals are shown in the scene as disks intersecting the points.

The scene below shows one point with a normal and one without:

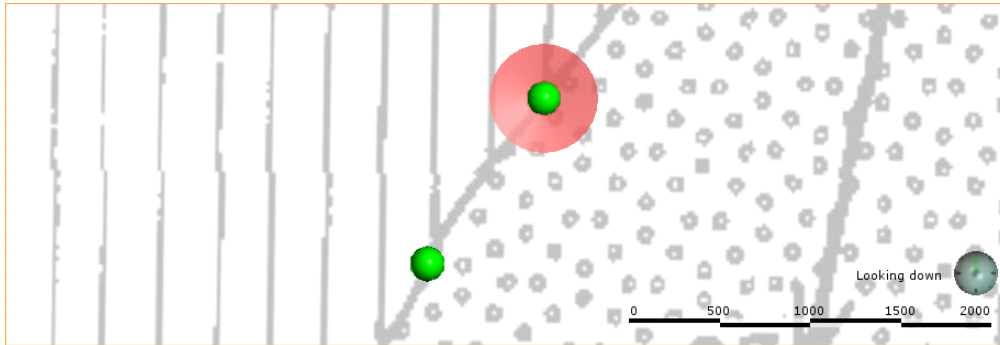

To move a point without a normal, switch to the **Select** tool (⌨). Click on the point and drag it. To add a normal to the point, click on it in the scene and click the **Add disk** button (🔲).

Editing Normals

To edit the orientation of a point with a normal, click on it in the scene. There are two rotation modes. In the first, the handles adjust the dip and azimuth of the disk:

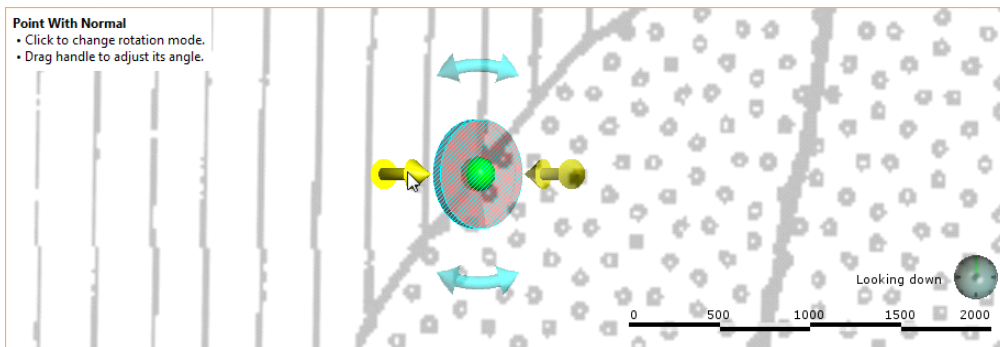

Click on the disk to change the rotation mode.

In the second rotation mode, dragging the disk rotates it in the plane indicated by the handles:

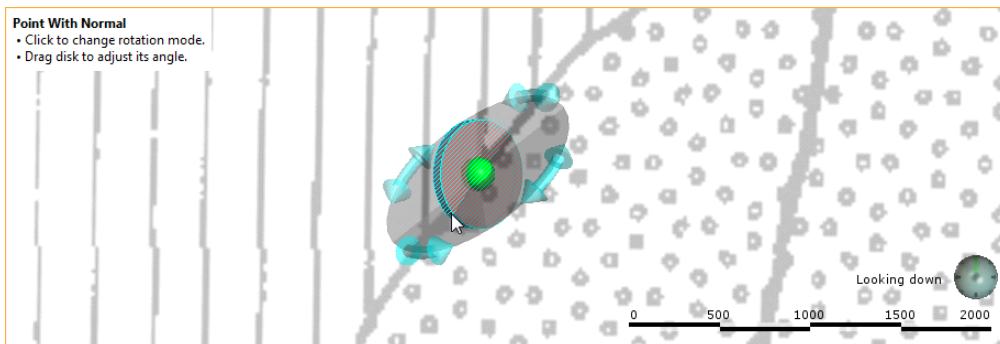

Change the angle of the plane by moving the mouse cursor over the disk.

You can also change the orientation of a disk by drawing over it. To do this, make sure the **Draw points** tool () is selected. Hold the cursor over the point you want to edit. The cursor will turn green to indicate that you can adjust the disk's angle:

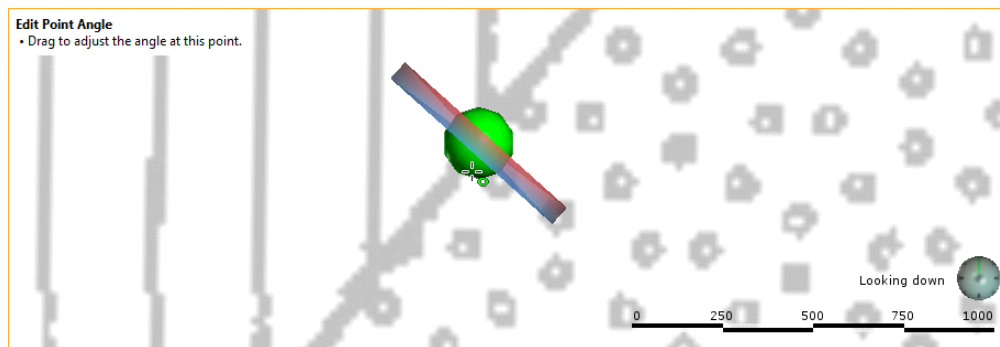

Drag to adjust the angle and release the mouse button when finished:

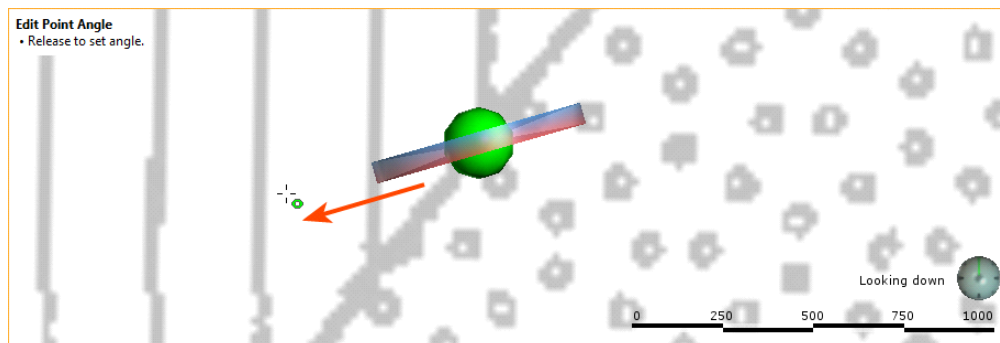

You can also flip selected disks by clicking on the **Flip tangents and disks** button ()

Organising Your Workspace

You can split the Leapfrog Geo main window into separate parts to make better use of your screen space. In addition, some Leapfrog Geo windows open in separate tabs that can be used either docked or detached. This topic describes how to change the main window to make the best use of your screen space. It is divided into:

- [Detaching Tabs](#)
- [Detaching and Minimising the Project Tree](#)
- [Organising the Scene View Tab](#)

Detaching Tabs

To detach a tab, either:

- Click on it and drag it away from the main window.
- Right-click on it and select **Move to New Window**.

You can then move and resize the detached tab.

To dock a detached tab, click on it and drag it to where you want to dock it:

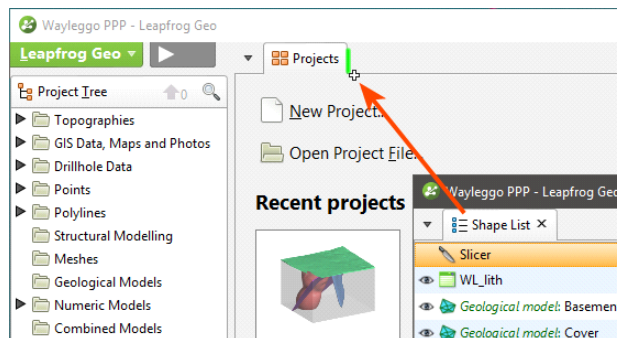

When the plus sign appears, release the mouse and the tab will dock.

Tabs can be docked to the main window or to other tabs. Drag tabs to reorder them.

You can view a list of all open tabs by clicking the down arrow to the right of the processing queue button:

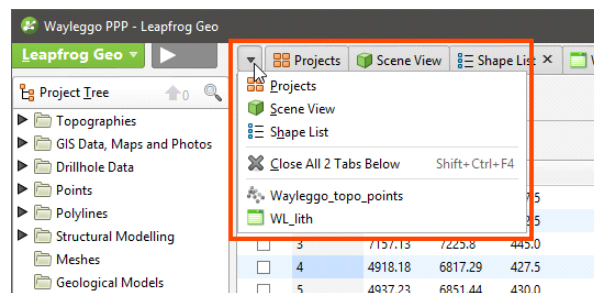

When you close a project, the position of open tabs will be saved and restored when the project is next opened.

For Leapfrog Geo windows that open in separate tabs, the position in which tabs open is determined by the **New tab position** setting in the **Settings** window:

- Open all tabs in the main window.
- Open all tabs in separate windows.
- Tabs can open where the last tab was moved to. This setting can be used for creating a window in which all tables and dockable windows open, with the scene window, project tree and shape list in another window.

To change this setting, click on the **Leapfrog Geo** menu, select **Settings** and then click on the **User Interface** tab.

Detaching and Minimising the Project Tree

The project tree can also be detached from the main window. To do this, right-click at the top of the project tree and select **Detach**:

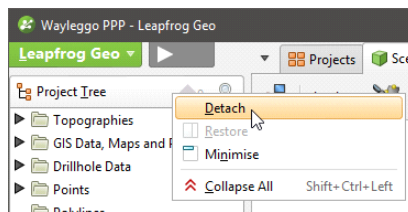

To reattach the project tree, click the red X to close the tab. It will reappear docked to the main window.

You can also minimise the project tree. To do this, right-click on it and choose **Minimise** or press the F8 key. Restore the project tree by clicking the button:

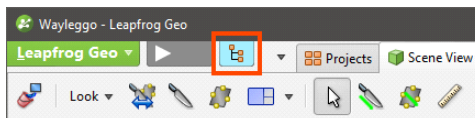

Pressing the F8 key once again also restores the project tree.

Organising the Scene View Tab

The **Scene View** tab is made up of the scene window, the shape list and the shape properties panel. The shape list and shape properties panel can be displayed on the right-hand side of the scene rather than below the scene. To do this, right-click in the shape list and select **Move List to Right**:

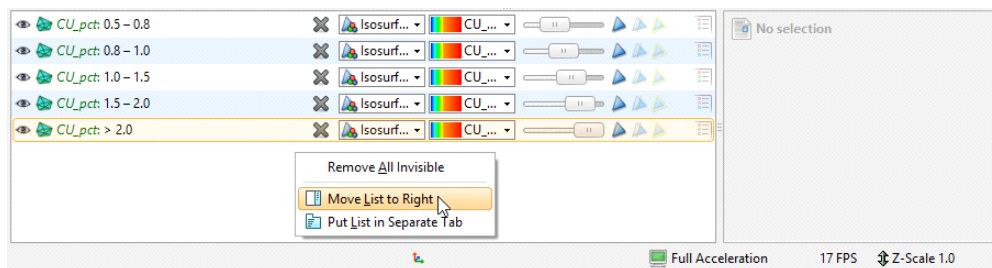

You can also detach the shape list and display it as a tab, which can then be detached from the main window. To do this, right-click in the shape list and select **Put List in Separate Tab**:

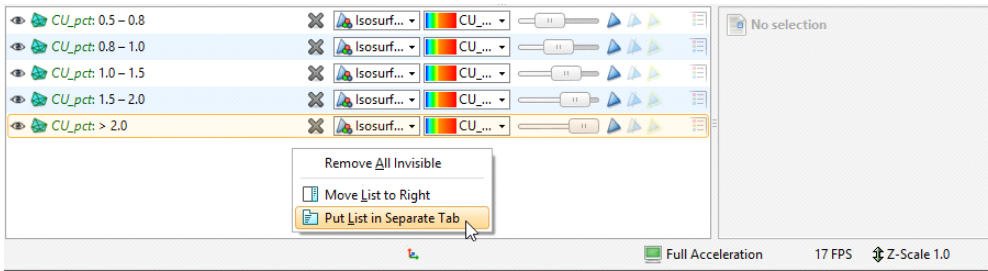

You can then detach the tab from the main window:

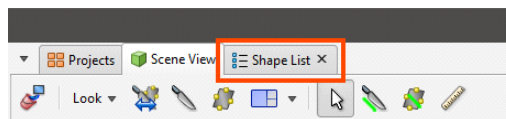

To dock the shape list to the **Scene View** tab, right-click in the **Shape List** tab and choose where you wish to dock the list:

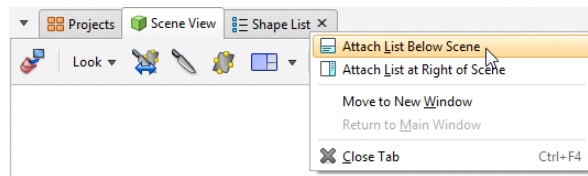

Interpolant Functions

Leapfrog Geo's powerful 3D interpolation engine can interpolate any numeric data (e.g. ore grade or piezometric head measurements) to describe how a real, numerical quantity varies in three dimensional space. Interpolation produces an estimate or "interpolated value" of a quantity that is not known at a point of interest but is known at other points.

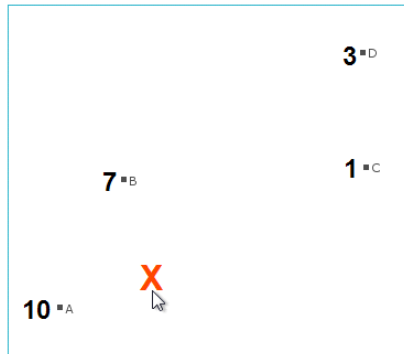

The simplest way to estimate values is to take the average of known values. Using this method, estimated values are the same everywhere, regardless of the distance from known data. However, this is not ideal as it is reasonable to assume that an estimated value will be more heavily influenced by nearby known values than by those that are further away. The estimates for unknown points when varying the distance from known point values is controlled by the interpolant function. Any interpolation function and the various parameters that can be set for each will produce a model that fits all the known values, but they will produce different estimates for the unknown points. It is important to select interpolation functions and parameters that make geologic sense. It may be necessary to identify a location that models predict differently, and plan drillholes to identify the best fit option.

Leapfrog Geo uses two main interpolant functions: the spheroidal interpolant function and the linear interpolant function. See [The Spheroidal Interpolant Function](#) and [The Linear Interpolant Function](#) for more information.

The Spheroidal Interpolant Function

In common cases, including when modelling most metallic ores, there is a finite range beyond which the influence of the data should fall to zero. The spheroidal interpolant function can be used when modelling in these cases.

The spheroidal interpolant function closely resembles a spherical variogram, which has a fixed range beyond which the value is the constant sill. Similarly, the spheroidal interpolant function flattens out when the distance from X is greater than a defined distance, the range. At the range, the function value is 96% of the sill with no nugget, and beyond the range the function asymptotically approaches the sill. The chart below labels the y-axis interpolant. A high value on this axis represents a greater uncertainty relating to the known value, given its distance from X. Another way to think of this is that higher values on this axis represent a decreasing weight given to the known value.

Known values within the range are weighted proportionally to the distance from X. Known values further from X than the range will all be given approximately the same weight, and have

about the same influence on the unknown value. Here, points A and B are near X and so have the greatest influence on the estimated value of point X. Points C and D, however, are outside the range, which puts them on the flat part of the spheroidal interpolant curve; they have roughly the same influence on the value of X, and both have significantly less influence than A or B:

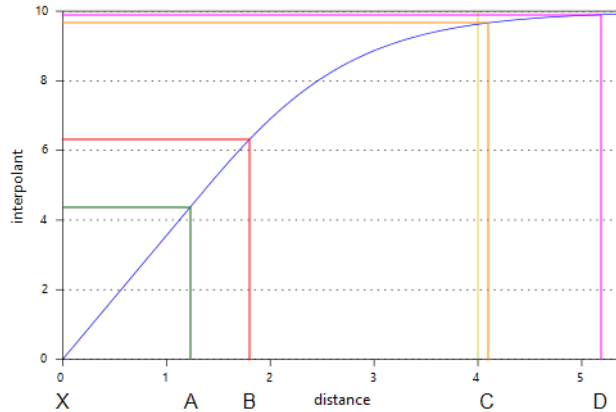

The rest of this topic describes the parameters used to define a spheroidal interpolant. These parameters are **Total Sill**, **Nugget**, **Nugget to Total Sill Ratio**, **Base Range**, **Alpha**, **Drift** and **Accuracy**.

To edit the parameters for an interpolant, double-click on the interpolant in the project tree and click on the **Interpolant** tab. The graph on the tab shows how the interpolant function values vary with distance and is updated as you change interpolant parameters:

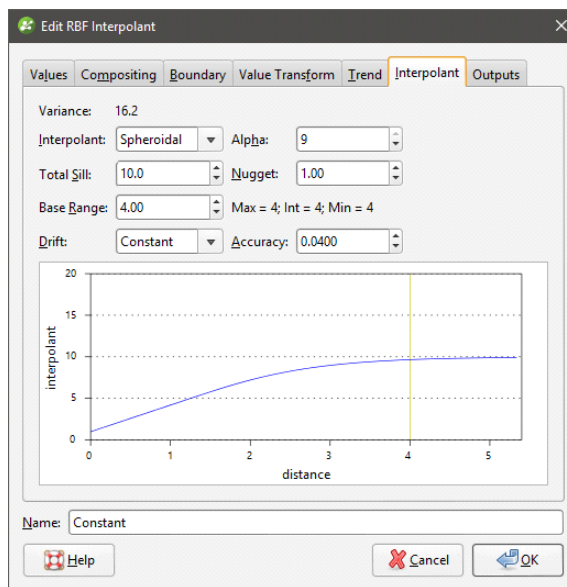

The yellow line indicates the **Base Range**. For this interpolant, the value of the interpolant is offset by the value of **Nugget**.

Total Sill

The **Total Sill** defines the upper limit of the spheroidal interpolant function, where there ceases to be any correlation between values. A spherical variogram reaches the sill at the range and

stays there for increasing distances beyond the range. A spheroidal interpolant approaches the sill near the range, and approaches it asymptotically for increasing distances beyond the range. The distinction is insignificant.

Nugget

The **Nugget** represents a local anomaly in sampled values, one that is substantially different from what would be predicted at that point, based on the surrounding data. Increasing the value of **Nugget** effectively places more emphasis on the average values of surrounding samples and less on the actual data point, and can be used to reduce noise caused by inaccurately measured samples.

Nugget to Total Sill Ratio

It is the **Nugget** to **Total Sill** ratio that determines the shape of the interpolant function. Multiplying both these parameters by the same constant will result in an identical interpolant. Here, the interpolant on the left has a nugget of 3 and a sill of 10; the one on the right has a nugget of 9 and a sill of 30. Note that because the nugget and sill have been increased by the same factor, the function has the same shape.

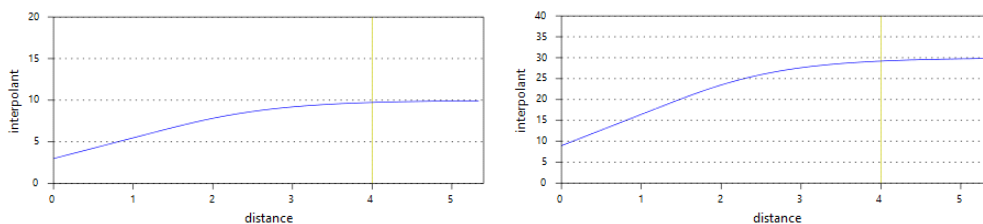

Base Range

The **Base Range** is the distance at which the interpolant value is 96% of the **Total Sill**, with no **Nugget**. The **Base Range** should be set to a distance that is not significantly less or greater than the distance between drillholes, so it can reach between them. As a rule of thumb, it may be set to approximately twice the average distance between drillholes.

Here the effect of different range settings on the value of X is demonstrated using our trivial example of four drillholes:

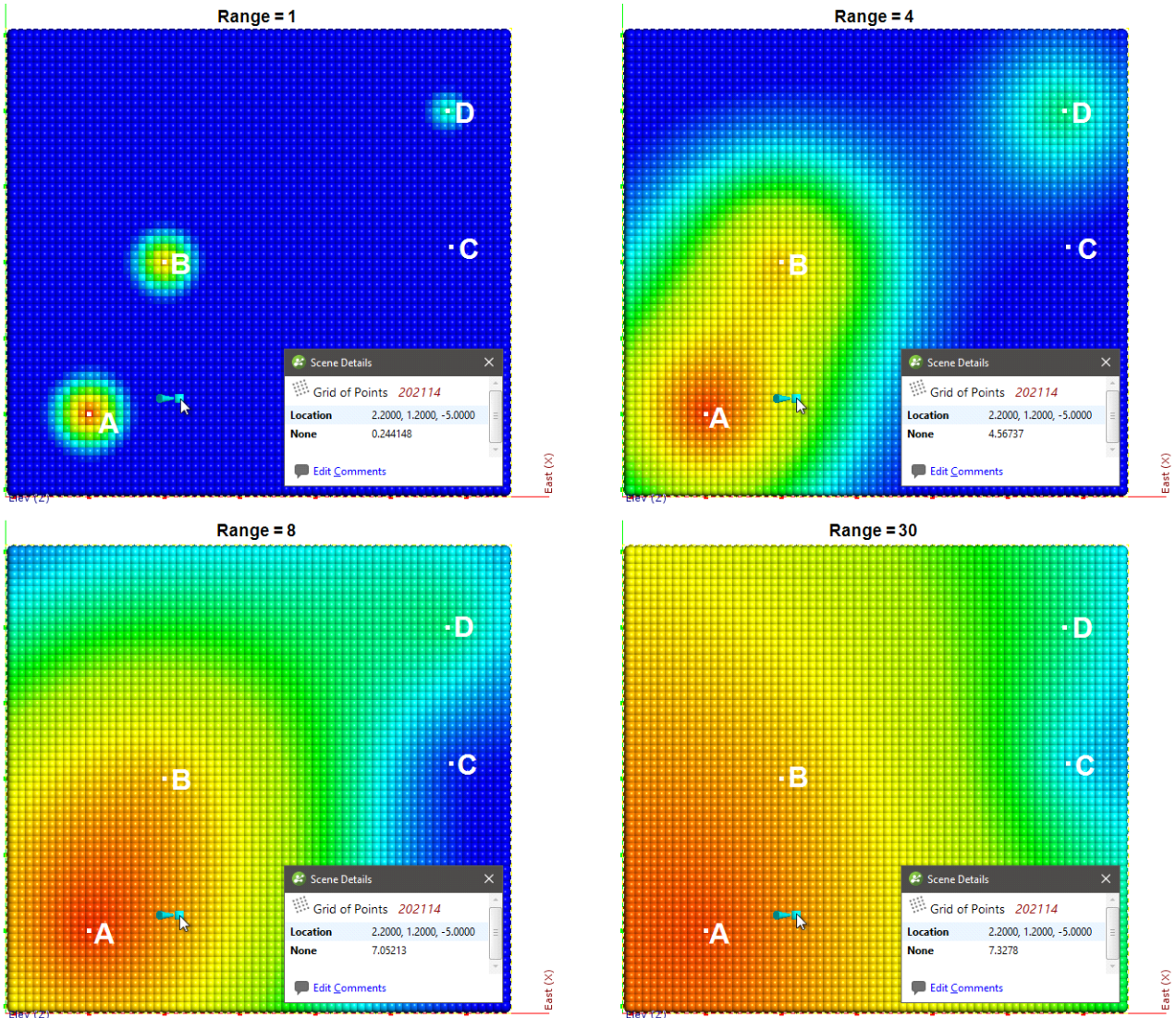

When the range is set to 1, it is too small to describe any real effect between drillholes. When the range is set to 30, distant drillholes have more influence, increasing the spatial continuity. Also illustrated is the range set to approximately the average distance between drillholes (range = 4) and the range set to about twice the average distance between drillholes (range = 8). Of these, the range set to 8 might be the best choice.

Alpha

The **Alpha** constant determines how steeply the interpolant rises toward the **Total Sill**. A low **Alpha** value will produce an interpolant function that rises more steeply than a high **Alpha** value. A high **Alpha** value gives points at intermediate distances more weighting, compared to lower **Alpha** values. This figure charts an interpolant function for each alpha setting, using a nugget of 8, sill of 28, and range of 5000. A spherical variogram function is included for comparative purposes. The inset provides a detailed view near the intersection of the sill and range.

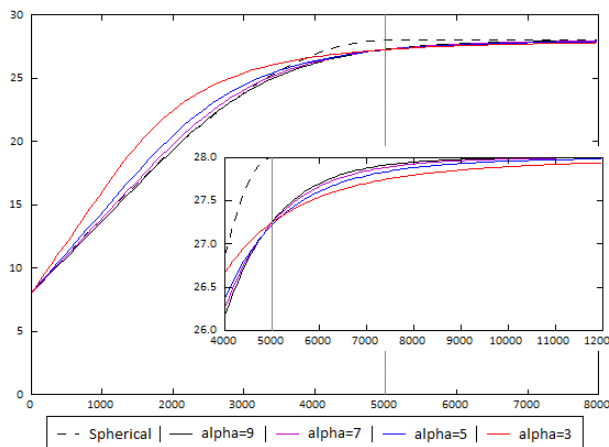

An alpha of 9 provides the curve that is closest in shape to a spherical variogram. In ideal situations, it would probably be the first choice; however, high alpha values require more computation and processing time, as more complex approximation calculations are required. A smaller value for alpha will result in shorter times to evaluate the interpolant.

The following demonstrates the difference between alpha = 3 and alpha = 9:

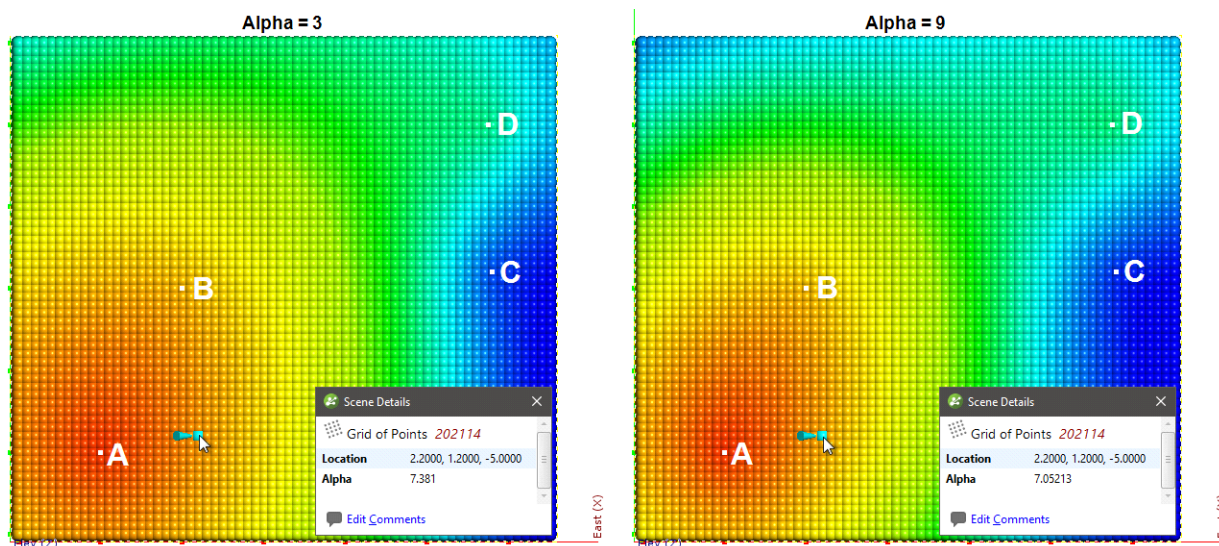

There is a measurable difference between the estimates at the point being examined, but for many purposes, using a lower alpha will result in satisfactory estimates and reduced processing time.

The effect of the alpha parameter on the spheroidal interpolant in Leapfrog Geo is different to the effect of the alpha parameter in Leapfrog Mining 2.x. If Alpha is set to 9 in Leapfrog Geo, the range corresponds to the range in Leapfrog Mining 2.x. To convert from Leapfrog Mining 2.x to Leapfrog Geo where the alpha is not 9, apply the following scale factors to the Leapfrog Mining 2.x range value to find the corresponding range in Leapfrog Geo:

Alpha	Scale factor
3	1.39
5	1.11
7	1.03

For example, if in a Leapfrog Mining 2.x project, the alpha is 5 for a range of 100, the corresponding range in Leapfrog Geo will be 111.

Drift

The **Drift** is a model of the value distribution away from data. It determines the behaviour a long way from sampled data.

- **Constant:** The interpolant goes to the approximated declustered mean of the data.
- **Linear:** The interpolant behaves linearly away from data, which may result in negative values.
- **None:** The interpolant pulls down to zero away from data.

Here, the three **Drift** options for the interpolant are shown evaluated on grids:

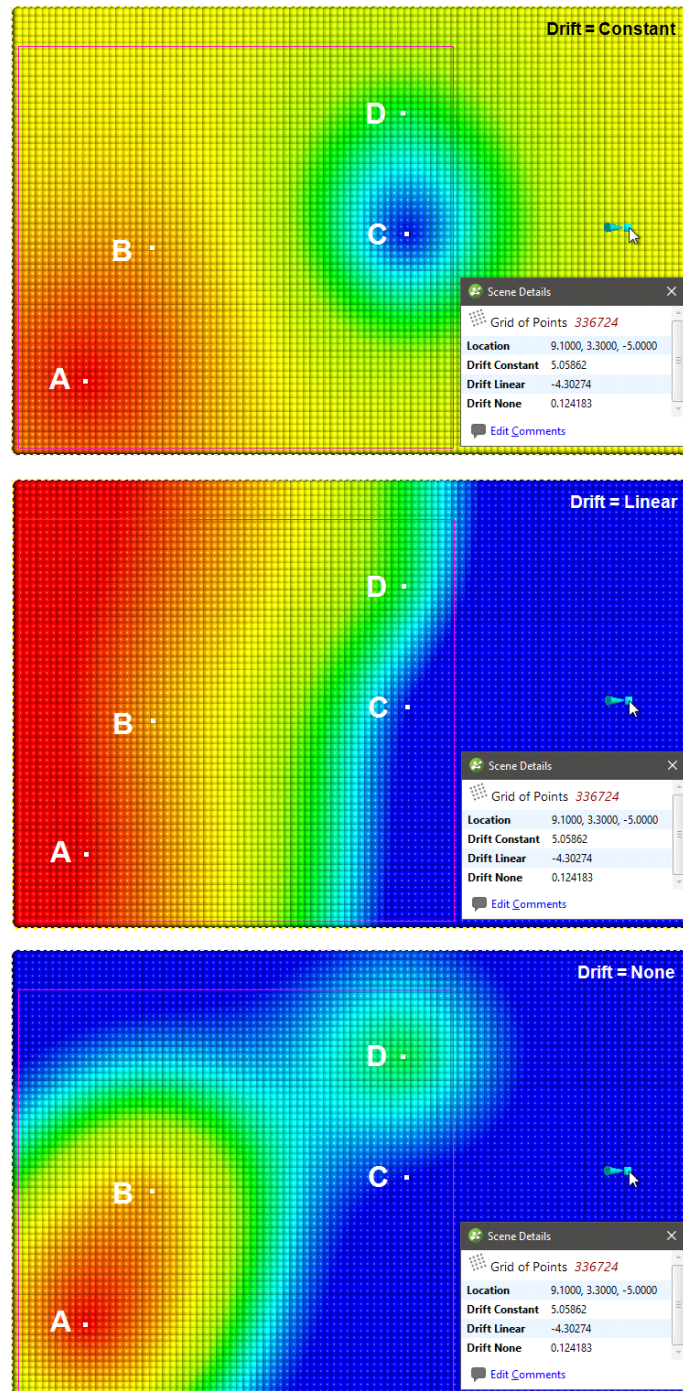

In this example, the boundary is larger than the extent of the data to illustrate the effect of different **Drift** settings.

Away from the data, the value of the interpolant when **Drift** is **Constant** and **Linear** is not reasonable in this case, given the distance from the data. The low value when **Drift** is **None** is more realistic, given the distance from the data.

If when using the spheroidal interpolant you get a grade shell that fills the model extents, it is likely that the mean value of the data is higher than the threshold chosen for the grade shell in question. If this occurs, try setting the **Drift** to **None**.

Accuracy

Leapfrog Geo estimates the **Accuracy** from the data values by taking a fraction of the smallest difference between measured data values. Although there is the temptation to set the **Accuracy** as low as possible, there is little point to specifying an **Accuracy** significantly smaller than the errors in the measured data. For example, if values are specified to two decimal places, setting the **Accuracy** to 0.001 is more than adequate. Smaller values will cause the interpolation to run more slowly and will degrade the interpolation result. For example, when recording to two decimals, the range 0.035 to 0.044 will be recorded as 0.04. There is little point in setting the accuracy to plus or minus 0.000001 when intrinsically values are only accurate to plus or minus 0.005.

The Linear Interpolant Function

Generally, estimates produced using the linear interpolant will strongly reflect values at nearby points and the linear interpolant is a useful general-purpose interpolant for sparsely and/or irregularly sampled data. It works well for lithology data, but is not appropriate for values with a distinct finite range of influence.

The linear interpolant function is multi-scale, and, therefore, is a good general purpose model. It works well for lithology data, which often has localised pockets of high-resolution data. It can be used to quickly visualise data trends and whether or not compositing or transforming values will be required. It is not appropriate for values with a distinct finite range of influence as it aggressively extrapolates out from the data. Most ore grade data is not well interpolated using a linear interpolant function.

The linear interpolant function simply assumes that known values closer to the point you wish to estimate have a proportionally greater influence than points that are further away:

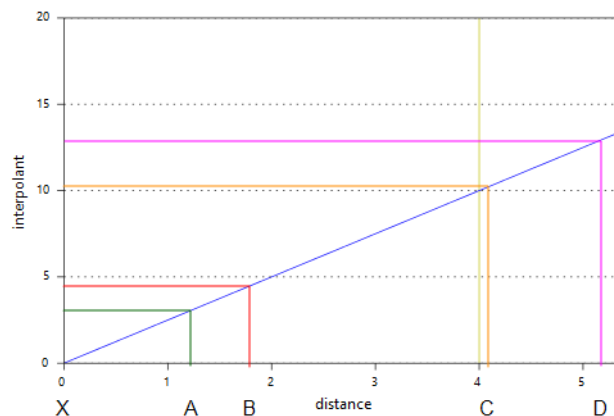

In the above diagram, points A and B will have the most effect on point X as they are closer to X than points C and D. Using the linear interpolant function in Leapfrog Geo gives a value of 7.85, which is between the nearby high grade values of A (10) and B (7). Because of their distance from X, the low grade values at C and D have a much weaker effect on the estimate of point X, and they have not dragged the estimate for X lower.

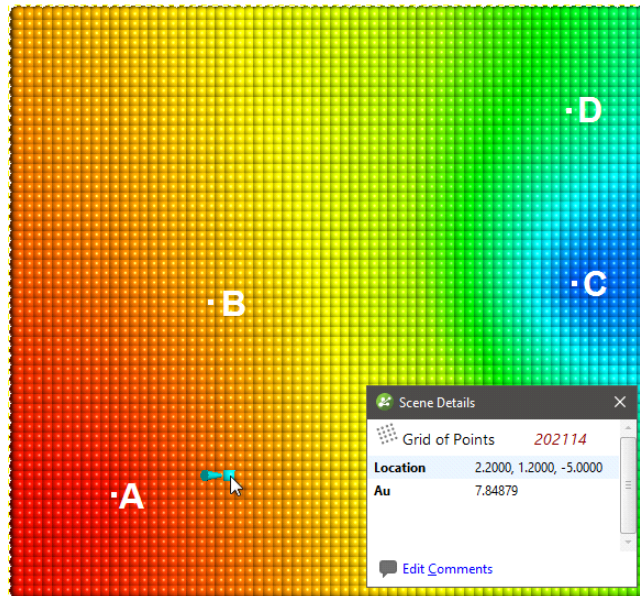

This topic describes the parameters used to define a linear interpolant. These parameters are **Total Sill and Base Range**, **Nugget**, **Drift** and **Accuracy**.

To edit the parameters for an interpolant, double-click on the interpolant in the project tree and click on the **Interpolant** tab. The graph on the tab shows how the interpolant function values vary with distance and is updated as you change interpolant parameters:

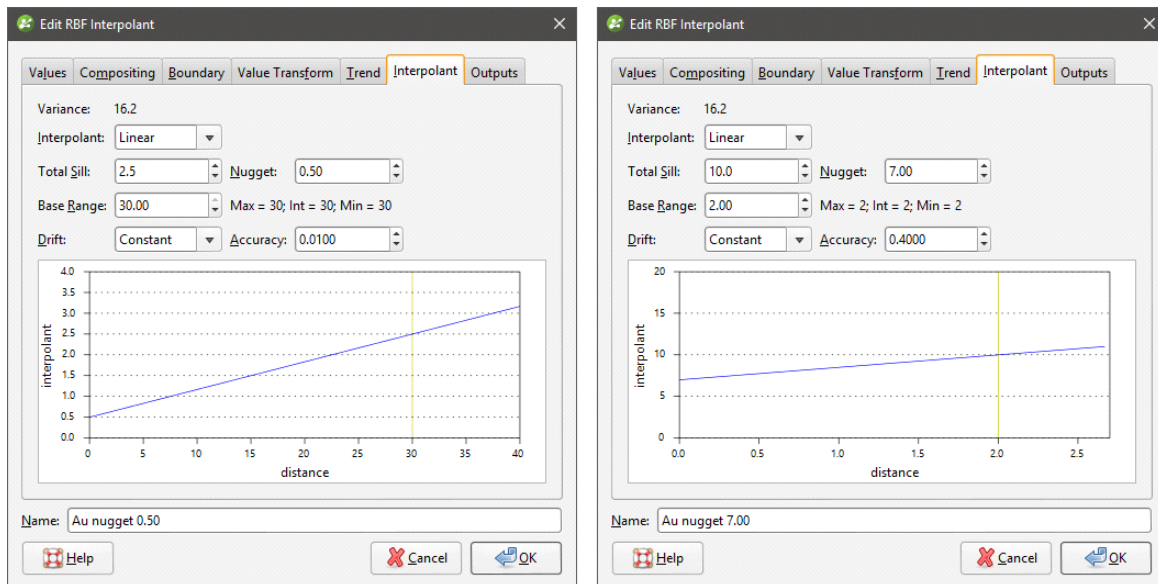

The yellow line indicates the **Base Range**. For this interpolant, the value of the interpolant is offset by the value of **Nugget**.

Total Sill and Base Range

A linear interpolant has no sill or range in the traditional sense. Instead, the **Total Sill** and **Base Range** set the slope of the interpolant. The **Base Range** is the distance at which the interpolant value is the **Total Sill**. The two parameters sill and range are used instead of a single gradient parameter to permit switching between linear and spheroidal interpolant functions without also manipulating these settings.

Nugget

The **Nugget** represents a local anomaly in values, one that is substantially different from what would be predicted at that point based on the surrounding data. Increasing the value of **Nugget** effectively places more emphasis on the average values of surrounding samples and less on the actual data point, and can be used to reduce noise caused by inaccurately measured samples.

Drift

The **Drift** is a model of the value distribution away from data. It determines the behaviour a long way from sampled data.

- **Constant**: The interpolant goes to the approximated declustered mean of the data.
- **Linear**: The interpolant behaves linearly away from data, which may result in negative values.

Here, the two **Drift** options for the interpolant are shown evaluated on grids:

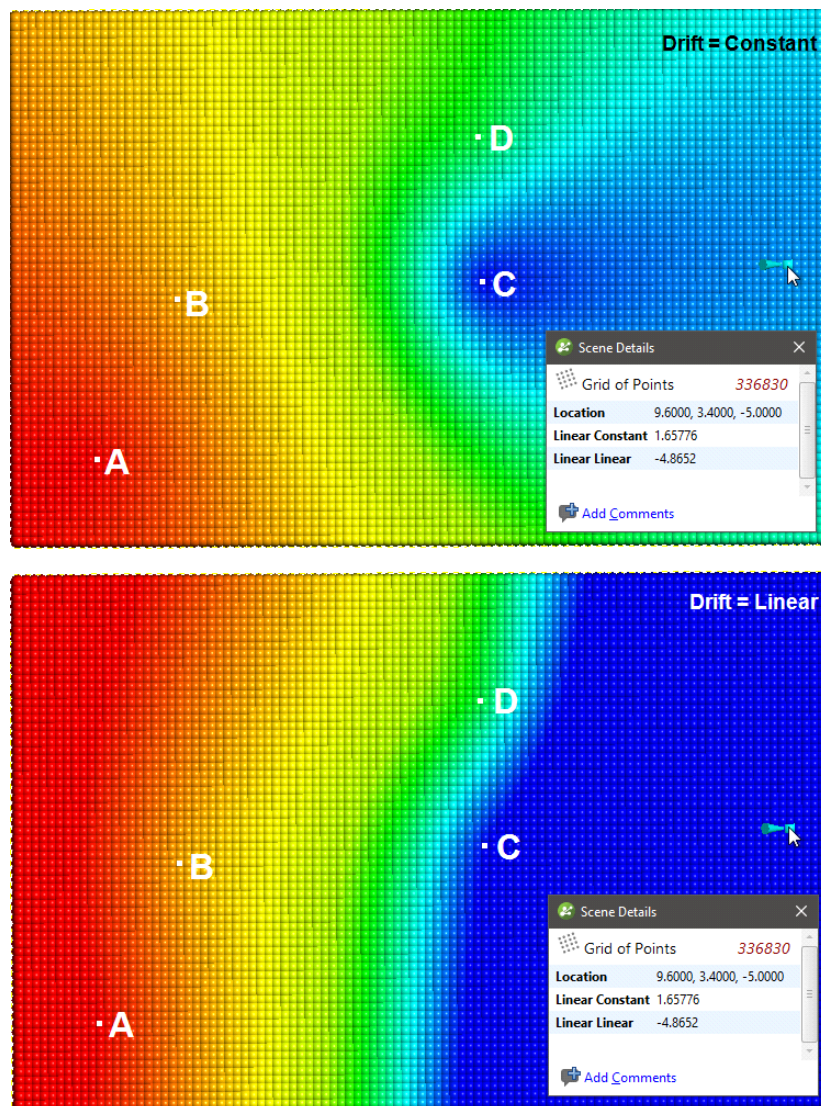

In this example, the boundary is larger than the extent of the data to illustrate the effect of different **Drift** settings.

Accuracy

Leapfrog Geo estimates the **Accuracy** from the data values by taking a fraction of the smallest difference between measured data values. Although there is the temptation to set the **Accuracy** as low as possible, there is little point to specifying an **Accuracy** significantly smaller than the errors in the measured data. For example, if values are specified to two decimal places, setting the **Accuracy** to 0.001 is more than adequate. Smaller values will cause the interpolation to run more slowly and will degrade the interpolation result. For example, when recording to two decimals, the range 0.035 to 0.044 will be recorded as 0.04. There is little point in asking Leapfrog Geo to match a value to plus or minus 0.000001 when intrinsically that value is only accurate to plus or minus 0.005.

Central Integration

The Central platform is a model management system. Central's integration with Leapfrog Geo lets you work in different project revisions, publish models to the server, view documents and annotations and reply to annotations.

Projects shared within Central can be downloaded and worked on locally in Leapfrog Geo. When you have finished working on a project, select the objects you wish to publish to Central and add notes about the revision. New projects can be added to Central by building them from scratch or by uploading an existing project.

This topic describes how to set up and work with Central from within Leapfrog Geo. It is divided into:

- [Enabling Central](#)
- [Setting Up the Connection](#)
- [Connecting to Central](#)
- [Viewing a Project's History](#)
- [Sharing Projects](#)
- [Downloading a Local Copy of a Project](#)
- [Publishing to Central](#)
- [New Central Projects](#)
- [Troubleshooting Connectivity Issues](#)

To learn more about Central, see the [Central help](#).

Enabling Central

To enable Central, open the **Settings** window by clicking on the **Leapfrog Geo** menu. Select **Central** and tick the box to enable Central. A **Central Projects** tab will appear in the main window.

When you connect to Central, you can download projects and work on them locally. To change the location where projects are saved, click the **Change** button under **Project Files** and navigate to where you want to save projects:

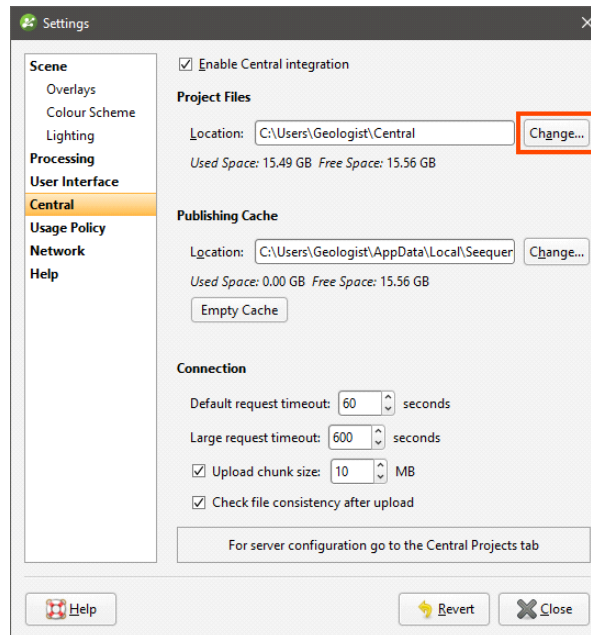

The **Publishing Cache** settings determine where Central data is stored while publishing to Central. If you have a small local drive and use network storage for most of your data, you can change where temporary publishing data is stored. To do this, click on the **Change** button and navigate to the required location.

The **Empty Cache** button clears the publishing cache folder for the connected Central Server. This button is only active when you are connected to a Central server and should only be used if you are having problems publishing to Central.

The **Connection** settings determine the timeout settings for connection to the Central server. The **Large request timeout** is used for publishing, uploading attachments and getting a revision. All other communication with the Central server uses the **Default request timeout**. The **Default request timeout** and **Large request timeout** should only be adjusted upward if you have problems with a poor connection. The default values are 60 seconds and 600 seconds.

The **Upload chunk size** setting is useful if you have a poor connection. It determines the size of the chunks used to upload large files. For example, if the **Upload chunk size** is 10MB and you are uploading a 100MB file, the file will be uploaded in 10 chunks. If your connection is poor and you are experiencing issues, you can decrease the value of the **Upload chunk size**.

There is an option for checking the integrity of a revision after it has been uploaded. If you wish to do this, enable the **Check file consistency after upload** option.

Setting Up the Connection

The first time you connect to Central, you will need to set up your connection. Request an account from your Central administrator, who will provide you with your connection details.

Once you have these details, click on the **Central Projects** tab. Click the **Add** button to add a new server:

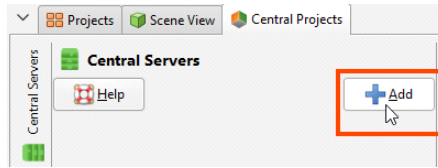

Click **New user** to enter your activation code, then enter the information provided to you by your Central administrator.

The activation code can be used a single time and is for the purposes of setting up your user name and password.

Enter a new password, then accept the terms and conditions and click **Save**.

Connecting to Central

Once Central integration has been enabled, you can see the status of your connection to Central in the lower left-hand corner of the Leapfrog Geo main window. Click this button to logout or change Central settings:



If you are logged out, click on the **Central Projects** tab and click the server you wish to connect to:

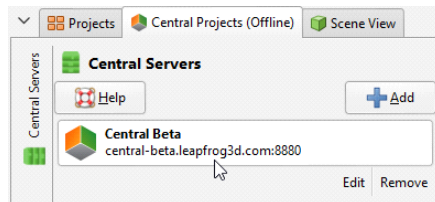

Leapfrog Geo version 4.5 is only compatible with Central Server version 2.2. If you get a message saying that the version of Leapfrog Geo you are using is not compatible with the Central Server you are trying to connect to, follow the instructions in the message, then try connecting again.

To hide the **Central Servers** panel, click the button:

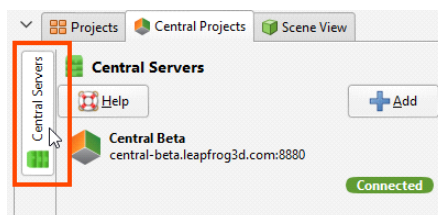

Viewing a Project's History

The **Central Projects** tab shows thumbnails of the projects available in Central. Projects will be organised by location if there are multiple projects at a given location; otherwise projects will simply appear in a list.

A project's location is set in the Central Portal. You cannot change its location from Leapfrog Geo.

Click on a project to view its history, which will open in a new tab.

Central projects are organised into revisions and branches:

- Different points in the modelling process are captured as revisions, which are specific points in time.
- A revision can be the basis for a new branch, exploring an alternative hypothesis.

These are displayed visually in a project's history tab, with local copies of projects shown in the panel at the top of the tab:

Graph	ID	Local	Locked	Project	Size	App Name	App Version	Project Stage	Branch	D
533	1	1	🔒	Leapfrog Geo	66.0MB	Leapfrog Geo	4.4.0 beta	Experimental	default	5
473				Leapfrog Geo	67.0MB	Leapfrog Geo	4.3.0 beta	Experimental	default	2
472				Leapfrog Geo	67.0MB	Leapfrog Geo	4.3.0 beta	Experimental	default	2
407				Leapfrog Geo	9.0MB	Leapfrog Geo	4.2.0 beta	Peer review	default	1
406				Leapfrog Geo	9.0MB	Leapfrog Geo	4.2.0 beta	Peer review	default	1
232				Leapfrog Geo	66.0MB	Leapfrog Geo	4.1.1	Peer review	default	6
110				Leapfrog Geo	128.0MB	Leapfrog Geo	4.0.0	Peer review	default	8
109				Leapfrog Geo	9.0MB	Leapfrog Geo	4.0.0	Peer review	default	2
108				Leapfrog Geo	9.0MB	Leapfrog Geo	4.0.0	Peer review	default	1
107				Leapfrog Geo		Leapfrog Geo	4.0.0	Peer review	default	8
18	2	2	🔒	Leapfrog Geo	125.0MB	Leapfrog Geo	3.1.0	Peer review	Dacite fold	1
17				Leapfrog Geo		Leapfrog Geo	3.1.0	Peer review	Dacite fold	1
15			🔒	Leapfrog Geo	116.0MB	Leapfrog Geo	3.1.0	Peer review	Cover re-model	2
14				Leapfrog Geo		Leapfrog Geo	3.1.0	Peer review	Cover re-model	1
13				Leapfrog Geo	114.0MB	Leapfrog Geo	3.1.0	Peer review	Cover re-model	1
12				Leapfrog Geo	112.0MB	Leapfrog Geo	3.1.0	Peer review	default	3
11				Leapfrog Geo	107.0MB	Leapfrog Geo	3.1.0	Resource Ready	default	9
10			🔒	Leapfrog Geo	123.0MB	Leapfrog Geo	3.1.0	Peer review	Dacite Dykes	2

Each local copy is numbered so that it can easily be seen what versions have local copies in the **Local** column. The number in the column corresponds to the project in the **Local copies** panel. You can also:

- Click a thumbnail to open a local copy.
- Click the branch/copy number button (🔗) to identify the parent version of the local copy in the project history.

- Click the **Publish** button (🌐) to publish the copy being edited to Central.
- Click the **Delete** button (🗑️) to delete a local copy, if the project is not open.

In the **Project history**, revisions are displayed chronologically, from the most recent down to the oldest. In the **Graph**, offshoots from a revision are branches where an alternative hypothesis has been investigated. Changes made in a branch do not appear in other branches; branches effectively diverge from the base revision. The dots on the graph line up with the revision information.

To view more information about a revision, click on it in the history.

Locking Branches

When working on a branch in Leapfrog Geo, the branch can be locked so no other Central users can make changes to it. This is useful for letting others users know that a model is being worked on.

The **Locked** column indicates whether or not the branch is available to be worked on. If a branch is locked, hold the cursor over it to see who locked it and when it will be available once again.

To lock a branch, right-click on it in the project history and select **Lock branch**:

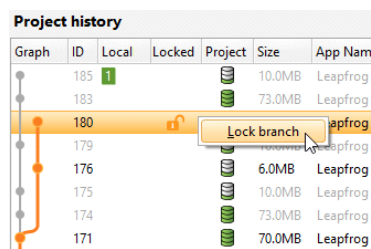

In the window that appears, set the **Lock duration** and add any comments. The lock can be set for as little as one day; when the lock expires or when a new publish is completed, the branch will be unlocked for other users. While the branch is locked, other users are still able to download projects, create new branches and publish to branches that are not locked.

If you locked a branch, you can unlock it before the lock expires by right-clicking on it and selecting **Unlock branch**:

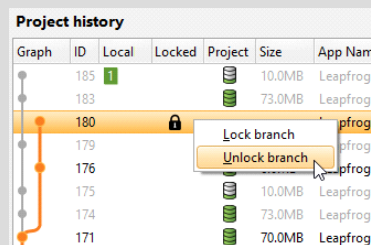

You can also ask your Central administrator to unlock a branch.

Project Included

The **Project** column indicates whether or not the Leapfrog Geo project was included when the revision was published. If there is no icon displayed, then no project was uploaded when the revision was published. You can view the revision in the Central Browser, but you cannot work on it in Leapfrog Geo.

When Leapfrog Geo projects are included in a revision, they can be published in a **Complete** state (🟢) or in an **Unprocessed** state (🟡). The difference between the two is whether or not stored modelling calculations are included in the published project. Removing stored modelling calculations can make the upload/download size of a revision considerably smaller and is useful when internet connectivity is poor. The tradeoff is that when the project is downloaded by a Leapfrog Geo user, the project will have to be reprocessed before they can use it. This may take some time.

Project Stages

The **Project Stage** is useful for promoting projects through an organisation's procedures. For example, your organisation may have project stages defined that include "Experimental", "Ready for Peer Review" and "Ready for Production". Different stages are displayed in different colours so it is easy to see at a glance what revisions belong to each stage.

Annotations and Attachments

With **Annotations**, Central Browser and Leapfrog Geo users can carry out conversations about specific aspects of the model. Annotations include a scene. If you already have the project open in Leapfrog Geo, you can load any scene from that project's history by clicking on it. Information about the selected scene will be displayed and you will be prompted to load all the objects or only the unchanged objects:

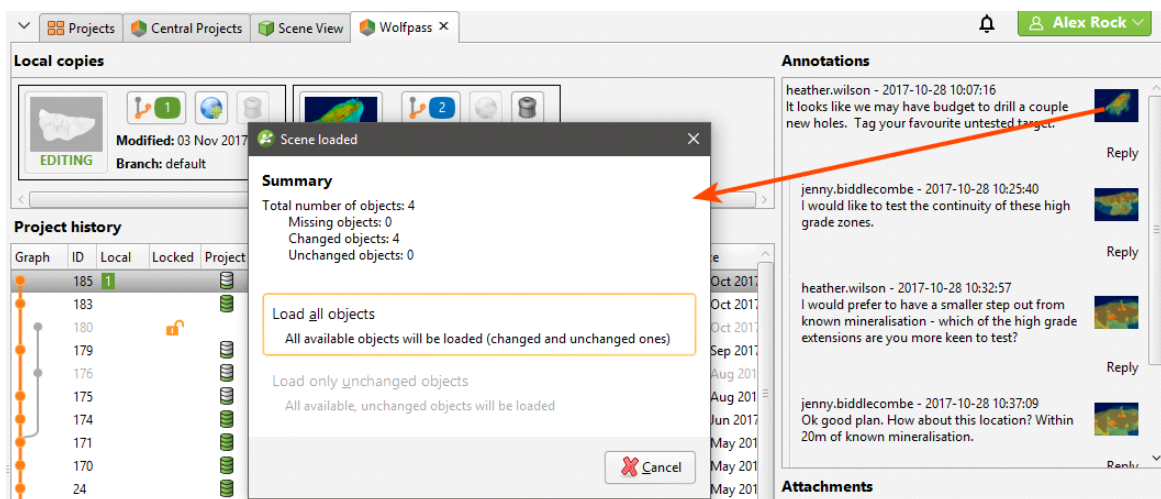

If the selected scene has a geotag, it will be added to the shape list and displayed in the scene. Central Browser users can also attach files, which can be downloaded in Leapfrog Geo.

Sharing Projects

If you are a project's owner, you can share it with other Central users by clicking the **Share Project** button in the project's history tab:

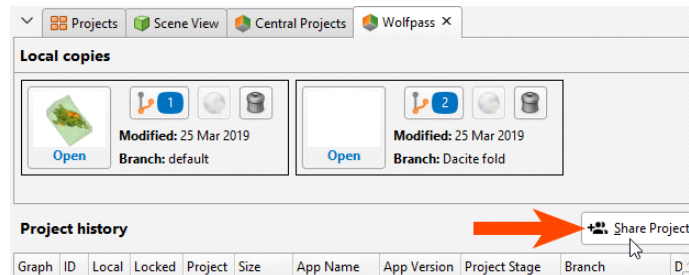

Clicking **Share Project** opens the Central Portal, displaying the list of users for that project:

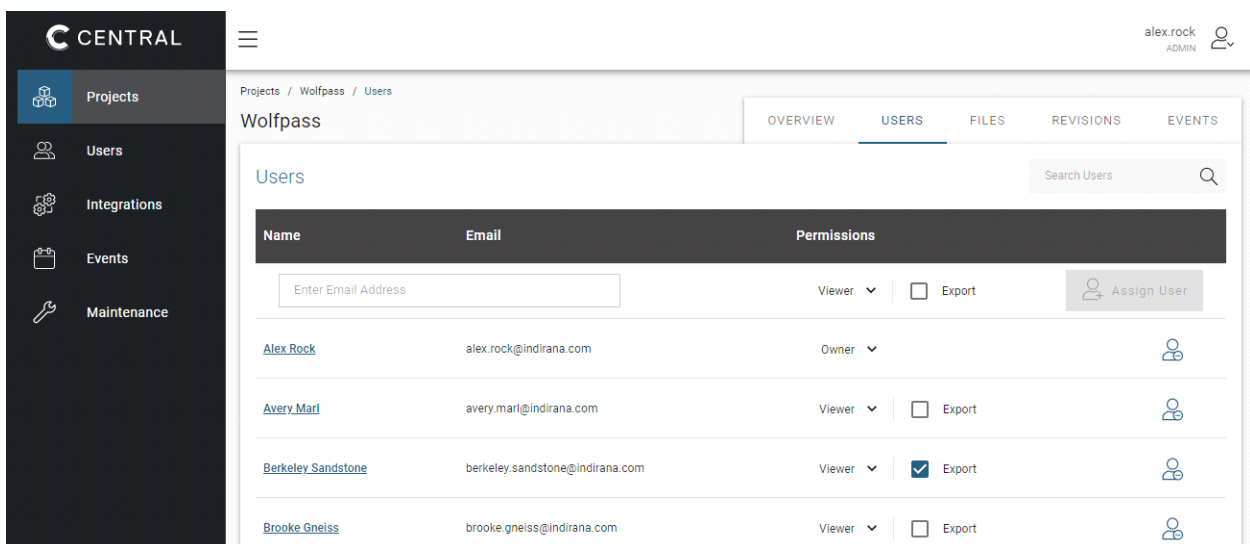

You may need to sign in to the Portal.

You can select from the other users in the system or enter a user's email address, then assign their permissions.

There are four levels of project permissions in Central: **Owner**, **Editor**, **Viewer+Export** and **Viewer**.

An **Owner** can:

- Assign other users as the owner. A project can have more than one owner.
- Configure and add an integration to a project they own.

A user who uploads a new project to Central is automatically assigned as the project owner.

Editor access allows a user to work in a project in Leapfrog.

Viewer+Export access allows a user to open a project in the Central Browser and export data from the project.

Viewer access allows a user to open a project in the Central Browser and make annotations. They cannot export data from the project.

Downloading a Local Copy of a Project

Select a revision and then click **Download** to download a local copy of the project. The project will be downloaded to the location on your local drive specified in the **Settings > Central** window. A new revision of the project will be created in the history, as an unpublished project.

Click the **Open** button in the **Local copies** panel to open the project:

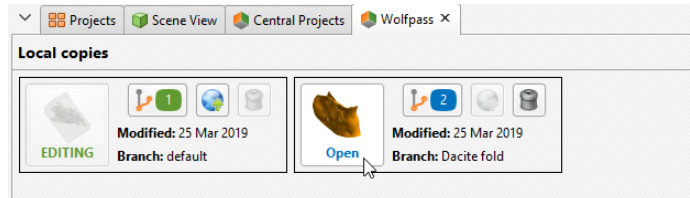

Work in the project as you would any other Leapfrog Geo project.

Publishing to Central

When you are ready to submit your project to Central, you can start the publishing process by clicking on the Central button in the lower left-hand corner of the screen and selecting **Publish**:

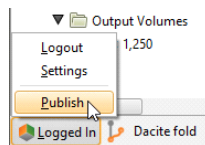

You can also select the **Publish** button (🌐) in the **Local copies** panel:

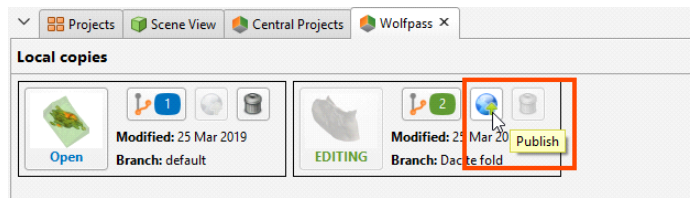

The steps in publishing a project to Central are:

- [Unfinished Publish Events](#)
- [Selecting Objects](#)
- [Setting the Project Workflow Stage](#)
- [Including the Project](#)
- [Adding Revision Information](#)
- [Preparing the Package](#)
- [Uploading the Package](#)

Unfinished Publish Events

When you click **Publish**, you may receive a message saying there is an unfinished publish event:

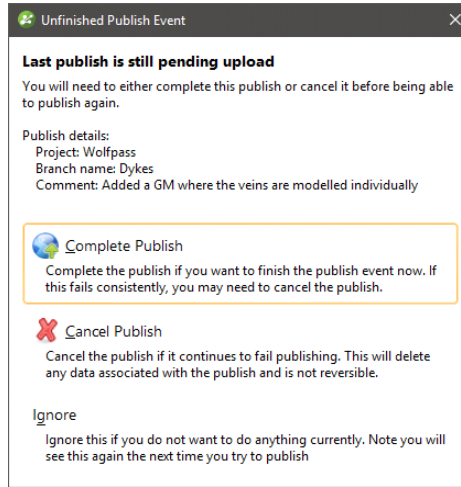

This occurs when a previous publish event was interrupted. Choose from the options presented. If the publish event was abandoned, it can be removed via the Central Portal.

Selecting Objects

Select the objects you wish to publish from those available in the project:

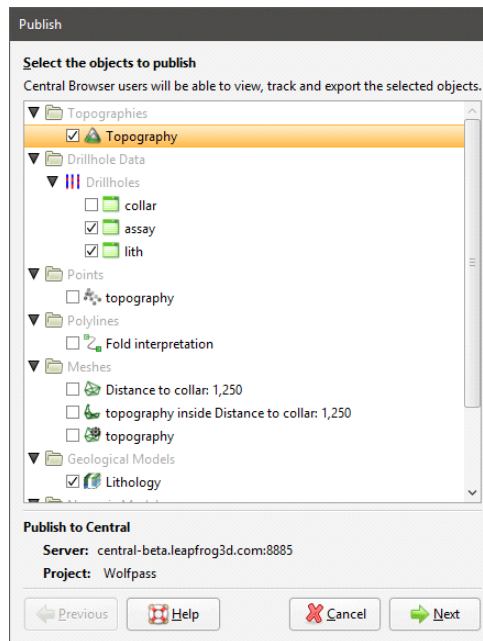

Although sub-blocked models can be published to Central, the dip will not be included.

Click **Next** to choose options for how the project will be uploaded.

Setting the Project Workflow Stage

Project stages are useful for advancing projects through an organisation's processes. If the project is ready to be moved on to a different stage, select a different **Project Workflow Stage** from the list.

Project stages can later be changed in the Central Browser.

Including the Project

Select whether or not to include the Leapfrog Geo project. There are three options:

- **No.** The Leapfrog Geo project will not be published. Other Central users will not be able to download the project and work on it in Leapfrog Geo. They will, however, be able to review the published objects and their history in the Central Browser.
- **Complete.** This option publishes the complete Leapfrog Geo project, including stored modelling calculations. Other Central users will be able to download the project and work on it in Leapfrog Geo without reprocessing the project.
- **Unprocessed.** An unprocessed project has a smaller upload/download size because stored modelling calculations are removed. When an unprocessed project is downloaded again, all of the modelling calculations will need to be reprocessed from the underlying data. Other Central users will be able to download the project and work on it in Leapfrog Geo. Depending on the size of the project, reprocessing may take some time.

Click **Next**.

Adding Revision Information

Enter information about the new revision. If you want to create a new branch, click the **New Branch** button and enter a name for the branch.

Once you branch from a timeline, you cannot merge back into it. There's no reason, however, that you can't keep working in a branch and start considering that the main branch, if that's the conclusion you and your team reach.

Preparing the Package

Click **Next** to begin the processes of packaging the project for publication.

Uploading the Package

Once the project has been packaged, there are two options for starting the upload:

- If you want the upload to begin automatically once the package has been prepared, tick the **Auto upload** box.

- If you want the option to cancel the upload once it has been packaged, leave the **Auto upload** box unticked. Once the project has been packaged, click **Publish** to upload the project to Central.

If for some reason you need to stop the upload, click on the Central button in the lower left-hand corner of the screen and select **Stop Upload**:

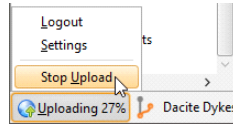

You can resume the upload by clicking **Publish** in the project history. You will be prompted to resume the unfinished publish event, as described in [Unfinished Publish Events](#) above.

If the upload is interrupted because the connection to the server is lost, you will be prompted to finish the publish event the next time you log in to Central.

If you exit Leapfrog Geo while a publish event is in progress, you will be warned that a publish event is in progress. You can:

- Cancel exiting Leapfrog Geo, in which case the publish event will continue.
- Confirm that you wish to exit Leapfrog Geo. The next time you connect to this Central server or publish from this project or from another project on the same server, you will be prompted to resume the interrupted publish event. You can complete the interrupted publish event, if you wish, or ignore it.

New Central Projects

There are two options for putting a project into Central:

- Create a new Central project.
- Put an existing project into Central.

Creating a New Central Project

Use this option to create a new Leapfrog Geo project and put it into Central. In the **Central Projects** tab, click **Create blank project**. Enter a name for the project and click **OK**. A new Leapfrog Geo project will be created and saved in the location on your local drive specified in the **Settings > Central** window.

Work in the project as you would any other Leapfrog Geo project. When you are ready to publish the project to Central, click on the Central button in the lower left-hand corner of the screen and select **Publish**:

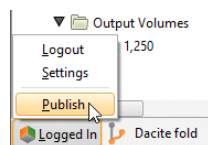

Adding a Project to Central

Use this option to add an existing project to Central.

Open the project you wish to import, then in the **Central Projects** tab, click **Import open project**. Enter a new name for the project, if you wish, then click **OK**. The project will be opened and copied to the location on your local drive specified in the **Settings > Central** window.

Work in the project as you would any other Leapfrog Geo project. When you are ready to publish the project to Central, click on the Central button in the lower left-hand corner of the screen and select **Publish**.

Troubleshooting Connectivity Issues

Leapfrog Start checks to see if your network will support the connection of Leapfrog web-based services to your desktop applications. If you are having trouble with your connection to Central, see [Checking Connectivity with Leapfrog Start](#).

Settings

Open the **Settings** window by clicking on the **Leapfrog Geo** menu and selecting **Settings**:

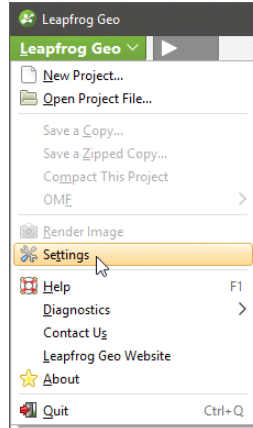

The settings available in this window are described below:

- [Display and Navigation Settings](#)
- [Overlay Settings](#)
- [Colour Scheme](#)
- [Lighting Settings](#)
- [Processing Settings](#)
- [User Interface Settings](#)
- [Central Settings](#)
- [Network Settings](#)
- [Help Settings](#)

To close the **Settings** window and leave settings unchanged, click the **Revert** button, then click **Close**.

Display and Navigation Settings

In the **Settings** window, click on **Scene** to change scene display and navigation settings.

3D Acceleration Mode

Leapfrog Geo can run in one of three acceleration modes. Click the **Acceleration mode** button in the **Settings > Scene** window to use a different mode. The modes available are:

- **Software Rendering** uses software only, for maximum compatibility with any hardware. This option can be very slow displaying all but the simplest scenes, and is provided as a fall-back if display issues cannot be resolved with either of the other two options.

- **Partial Acceleration** uses hardware acceleration that has been provided on graphics cards for many generations. In this mode, Leapfrog Geo renders scenes using “fixed function pipeline” hardware acceleration features that have been superseded in modern graphics cards by programmable shaders, but this legacy capability is widely supported and offers performance advantages over software rendering. Using **Partial Acceleration** can sometimes fix anomalies or problems encountered in **Full Acceleration** mode that may be due to bugs in old drivers, and it should work with even old or lower-featured hardware.
- **Full Acceleration** is the best option, assuming you have good hardware and up-to-date drivers. Because it makes use of programmable shaders provided by modern graphics cards, it is the fastest of the three modes and uses your available graphics memory more efficiently. It is the mode you should use, if your system supports it.

First, try using **Full Acceleration** and see how it renders scenes. If you seem to be having issues with how data is displayed in the scene, see [Running the Graphics Test](#) for information on testing your computer’s graphics capabilities. Note that especially when graphics cards are new on the market, there may be a number of driver versions released to address anomalies, so the use of a recent driver version is important. If using a laptop with dual graphics cards, use it with the power supply connected, and select the **Performance Graphics** option over the **Power Saving** option.

If that doesn’t resolve the graphics problems, then try **Partial Acceleration** mode. If possible, avoid using **Software Rendering** as it can be very slow.

If your current hardware is unable to support **Full Acceleration** mode, it may be worth considering upgrading your graphics card. Medium- to high-end home PC and gaming graphics cards are sufficient. High-end workstation grade cards also work very well, but you will also be paying for further capabilities that are not utilised by Leapfrog Geo.

The acceleration mode can also be changed by clicking the button at the bottom of the Leapfrog Geo main window:

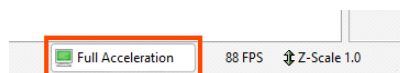

Font Size

This setting is the size of text used to display information on the grid and axes.

Z Axis Scale

The **Z-axis scale** setting lets you set a value greater than 1.0 for the z-axis relative to the x- and y-axes. This is useful when the area under study is very planar and extends over a wide area. In such cases, scaling the z-axis can accentuate the distribution of data along the z-axis. If you have a project open when you change this setting, the change will be reflected in the scene so you can experiment with different values before choosing the one that best accentuates the distribution of data.

The z-axis setting can also be changed by clicking the **Z-Scale** button at the bottom of the Leapfrog Geo main window:

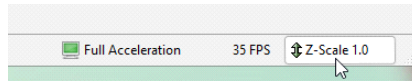

The **Scale Z Axis** window will appear:

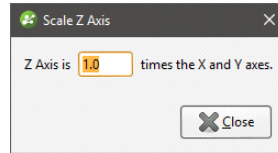

Note that each project saves the z-axis scaling setting when the project is closed. In addition, when saving scenes (see [Saved Scenes](#)), the z-axis scale is saved as part of the scene.

Rotation Settings

The **Geographic rotation** and **Free rotation** settings determine whether or not the model displayed in the scene window can be “rolled”. With the **Geographic rotation** option, the azimuth and elevation can be varied, but the z-axis is constrained to be vertical. With the **Free rotation** option, however, the rotation of the model is not fixed to any axis and the model can be freely rolled around any axis. Select the option you prefer. When Leapfrog Geo is installed, **Geographic rotation** is set as the default option as it is the most commonly used.

The **Rotate with left button** and **Rotate with right button** settings determine how the mouse is used to rotate the scene:

- When **Rotate with left button** is selected, you can rotate the scene by holding down the left mouse button and dragging in the scene. Clicking and holding the right mouse button zooms in and out of the scene.
- When **Rotate with right button** is selected, holding down the right mouse button and dragging rotates the scene. However, zooming and rotating functions are not swapped. Instead, the left mouse button can only be used for clicking on different objects in the scene. Select this option if you tend to accidentally move the scene when you intend to click.

Camera Settings

The **Orthographic projection** and **Perspective projection** settings determine the view of the model in the scene window.

If **Perspective projection** is selected, you can change the **Perspective angle** using the slider. This is similar to adjusting the zoom setting on a camera. Higher angles make nearby objects larger and more distant objects smaller. Lower angles will compress the scene. Experiment with the settings to see the effect on objects in the scene.

Select the option you prefer.

Overlay Settings

In the **Settings** window, click on **Scene > Overlays** to change what objects are included in the scene.

Changes you make to these settings are automatically updated in the scene so you can easily experiment to see what overlays you prefer.

Select **Revert** to return to the settings in place when the **Settings** window was first opened.

Screen Grid Settings

The **Show screen grid** setting determines whether or not the screen grid is displayed. Select the option you prefer. The **Loose Spacing**, **Normal Spacing** and **Fine Spacing** options determine the spacing of the grid.

Axis Lines Settings

The **Axis Lines** settings determine how X-Y-Z coordinates are displayed in the scene. When axis lines are enabled, the axes indicate the extent of data currently displayed in the scene.

- Enable **Show axis lines** to display the east (red), north (green) and elevation (blue) axis lines.
- Enable **Put numbers on axes** to display scale ticks along the grid. These are automatically adjusted to fit the extent of the data and the current zoom setting.
- Enable **Show whole box** to display the axis lines as a box that encloses the current data set.

Other Overlay Settings

The scale bar, compass ball and viewing angle text are the navigation aids in the lower right-hand corner of the scene window.

When the slicer is in the scene and the slice is aligned with the x-, y- or z-axis, text describing the slicer position can be displayed in the lower left-hand corner of the scene. To do this, enabled the **Slicer position text** option.

When drawing polylines, tooltips are displayed. If you do not wish to view these tooltips, untick the box for **Polyline help text**.

Colour Scheme

In the **Settings** window, click on **Scene > Colour Scheme** to change the colour scheme used in the scene. The options that can be changed include:

- The background colour used in the **Scene View** tab
- The colour and width used to display drillhole traces

- The colour and width of mesh edges, together with the width of the line used when a mesh is sliced and the highlight colour used when mesh parts are selected in the scene
- The colours used for displaying the x, y and z axes
- Grid line width, style and colour
- Axes box line width, style and colour
- Slicer edge width, style and colour

Leapfrog Geo is installed with three colour schemes: **Default**, **Black Background** and **White Background**. The scheme selected in the **Schemes** list will be used for all new Leapfrog Geo projects and for existing projects when they are next opened.

- Experiment with the settings to see how they affect the scene window. The scene will be updated as you make changes.
- Select **Revert** to return to the settings in place when the **Settings** window was first opened.
- To create a new scheme, click on an existing scheme. This is the scheme that will be used as a basis for defining the new scheme. Next, click the **New Scheme** button and change its settings.
- Click **Factory Reset** to revert to the colour schemes defined when Leapfrog Geo was first installed.

Clicking on **Factory Reset** to revert to the original colour schemes deletes any custom colour schemes.

If you are working on a slow connection, you can download a copy of the help that can be saved to your hard drive. To do this:

- [Click here to download a copy of the help.](#)
- Once you have downloaded a copy of the help and installed it, select **Settings** from the **Leapfrog Geo** menu.
- Click on the **Help** tab and then select **Local folder**.

Leapfrog Geo help is updated at each release. If you are using a downloaded copy, you will need to download a new copy each time you update Leapfrog Geo.

Lighting Settings

In the **Settings** window, click on **Scene > Lighting** to change how visual effects are displayed in the scene window. You may be able to use these settings to emphasise significance in the data displayed in the scene.

- The **Ambient level** setting determines the overall brightness of the scene.
- The **Specular brightness** and **Specular shininess** settings determine how light appears to fall on the surfaces in the scene. The **Specular brightness** setting has a stronger effect when **Specular shininess** is soft.

You can have up to four light sources defined for a project. By default, two light sources are defined.

Changes made to these settings are automatically applied to the scene.

- Click **Revert** to return to the settings in place when the **Settings** window was first opened.
- Click **Factory Reset** to revert to the lighting sources and settings defined when Leapfrog Geo was first installed.

Processing Settings

In the **Settings** window, click on **Processing** to change how background processing is used to run changes to data and models. The **Automatic** option creates one process for each physical CPU core on your computer or one for every 2.5 GB of RAM, whichever is smaller. However, there is an upper limit of 8 processes.

You can manually set the number of **Background processes** you would like to commit resources to. For example, you might want to use all but one process for Leapfrog Geo and reserve one for other application use.

Select **Revert** to return to the settings in place when the **Settings** window was first opened.

User Interface Settings

In the **Settings** window, click on **User Interface** to change project tree and scene toolbar options and to enable uploading to View.

Show Tree Lines

Ticking the box for **Show Tree Lines** displays objects in the project tree with lines:

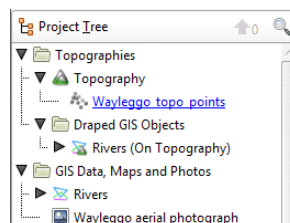

Enable this option if you find it useful for displaying relationships between objects in the project tree.

Show Save Scene Button

Ticking the **Show Save Scene** box adds an extra button to the scene toolbar:

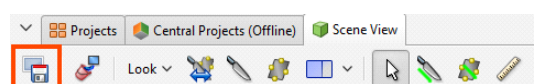

Click this button to save the current scene.

You can also change the scene toolbar by right-clicking on it and selecting **Customise**.

Upload to View

Ticking the box for **Show View upload** displays the **View** button (📁) in the **Scene View** toolbar. See [Uploading to View](#) for more information.

Tab Position

Some Leapfrog Geo windows open in separate tabs that can be used either docked or detached. The position in which tabs open is determined by the **New tab position** setting:

- Open all tabs in the main window.
- Open all tabs in separate windows.
- Tabs can open where the last tab was moved to. This setting can be used for creating a window in which all tables and dockable windows open, with the scene window, project tree and shape list in another window.

Central Settings

To enable Central, open the **Settings** window by clicking on the **Leapfrog Geo** menu. Select **Central** and tick the box to enable Central. A **Central Projects** tab will appear in the main window.

When you connect to Central, you can download projects and work on them locally. To change the location where projects are saved, click the **Change** button under **Project Files** and navigate to where you want to save projects:

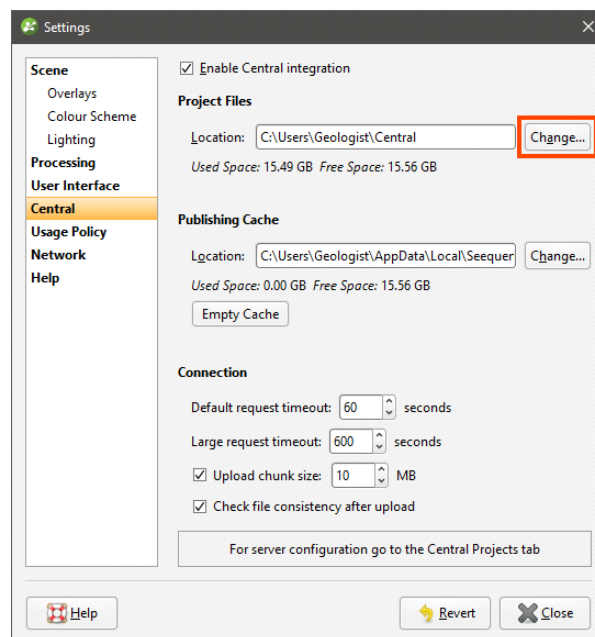

The **Publishing Cache** settings determine where Central data is stored while publishing to Central. If you have a small local drive and use network storage for most of your data, you can change where temporary publishing data is stored. To do this, click on the **Change** button and navigate to the required location.

The **Empty Cache** button clears the publishing cache folder for the connected Central Server. This button is only active when you are connected to a Central server and should only be used if you are having problems publishing to Central.

The **Connection** settings determine the timeout settings for connection to the Central server. The **Large request timeout** is used for publishing, uploading attachments and getting a revision. All other communication with the Central server uses the **Default request timeout**. The **Default request timeout** and **Large request timeout** should only be adjusted upward if you have problems with a poor connection. The default values are 60 seconds and 600 seconds.

The **Upload chunk size** setting is useful if you have a poor connection. It determines the size of the chunks used to upload large files. For example, if the **Upload chunk size** is 10MB and you are uploading a 100MB file, the file will be uploaded in 10 chunks. If your connection is poor and you are experiencing issues, you can decrease the value of the **Upload chunk size**.

There is an option for checking the integrity of a revision after it has been uploaded. If you wish to do this, enable the **Check file consistency after upload** option.

See [Central Integration](#) for more information on using Central.

Network Settings

If your organisation uses a proxy server to connect to the internet, you can set this up in the **Settings > Network** window.

If you choose the **Autodetect proxy server** option, Leapfrog Geo will detect the authentication type, server address and port; there are no further settings for you to change.

If **Autodetect proxy server** does not work or if you need to switch between proxy servers in different network environments, choose the **Manually configure proxy server** option and enter the information provided by your IT department. The advanced settings are optional and you should only change them from the default values if you have been instructed to do so by your IT department.

You can manually configure more than one proxy server. Click the **New** button to add a new profile and enter the required settings. When you want to swap from one proxy server to another, simply select a **Profile** from those already defined.

If you have multiple Seequent products running on your computer, you only need to configure network proxy settings once. Once you have, for example, configured the proxy for Leapfrog Geo, the same settings will be used for the Central Browser.

Help Settings

If you are working on a slow connection, you can download a copy of the help that can be saved to your hard drive. To do this:

- [Click here to download a copy of the help.](#)
- Once you have downloaded a copy of the help and installed it, select **Settings** from the **Leapfrog Geo** menu.
- Click on the **Help** tab and then select **Local folder**.

Leapfrog Geo help is updated at each release. If you are using a downloaded copy, you will need to download a new copy each time you update Leapfrog Geo.

Reporting a Problem

If Leapfrog Geo encounters an error, the **Leapfrog Geo Problem** window will be displayed. Enter as much information as you can about the problem, then click **Send**.

Getting Support

Technical support is available by visiting <http://www.leapfrog3d.com/contact/support>.

Checking Connectivity with Leapfrog Start

Leapfrog Start checks to see if your network will support the connection of Leapfrog web-based services to your desktop applications.

To run Leapfrog Start, either click the **Test Web Services** button in the **Settings > Network** window or click on the **Leapfrog Geo** menu and select **Diagnostics > Test Web Services**:

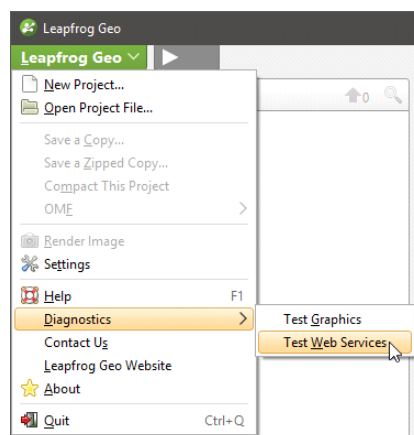

Supplying Your Licence Details

When contacting technical support, please include your licence number and a full description of the problem or query, including any information provided in system error messages.

You can access your licence information by selecting **About** from the **Leapfrog Geo** menu:

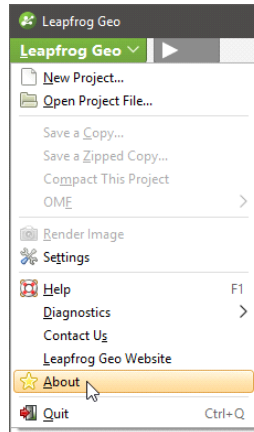

You may also be asked to provide a copy of the log files. To find out where these are stored, select **About** from the **Leapfrog Geo** menu, then click on the **System Info.** tab. Click on the link to open the folder that contains the log files:

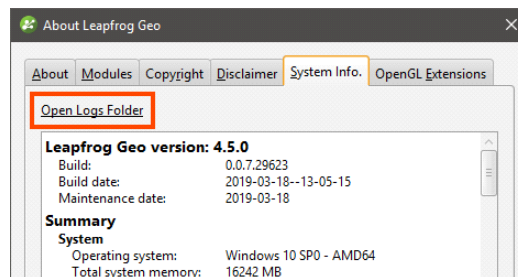

Data Types

Leapfrog Geo has tools for importing, creating and working with many different types of data, including:

- [GIS Data, Maps and Images](#)
- [Drillhole Data](#)
- [Points Data](#)
- [Structural Data](#)
- [Meshes](#)
- [Polylines](#)
- [Geochemical Data](#)

Leapfrog Geo is unit-less and adopts the units used in the data you import. For example, if your imported data is in metres, the units displayed will be metres, and figures such as resolution, measured distances and slicer thickness will be in metres. It is important, therefore, to be consistent in the units used in the data you import. If you are importing data that uses different coordinate systems, you will need to pre-process the data so that it is using the same coordinate system.

The rest of this topic describes how to open, edit and correct errors in data tables in Leapfrog Geo. It is divided into:

- [Working with Data Tables](#)
- [Identifying Errors in Data Tables](#)
- [Exporting Data Errors](#)
- [Correcting Data Errors in Leapfrog Geo](#)
- [Common Errors and How to Fix Them](#)
- [Handling Special Values](#)

Working with Data Tables

To view the contents of a data table, double-click on it in the project tree. To view the contents of the attribute table for a GIS object, right-click on the object and select **Attribute Table**. The **Table** window will appear:

Ignored	trench	id	holeid	x	y	z	maxdepth	Completed
<input type="checkbox"/>	<input type="checkbox"/>	1	M001	3999.231	7499.063	727.169	250.0	1996-03-05
<input type="checkbox"/>	<input type="checkbox"/>	2	M002	4050.382	7500.755	726.926	250.0	1996-03-09
<input type="checkbox"/>	<input type="checkbox"/>	3	M003	4098.904	7500.572	727.68	250.0	1996-03-14
<input type="checkbox"/>	<input type="checkbox"/>	4	M004	4149.058	7501.102	728.876	275.0	1996-03-20
<input type="checkbox"/>	<input type="checkbox"/>	5	M005	4199.59	7499.877	729.739	300.0	1996-03-27
<input type="checkbox"/>	<input type="checkbox"/>	6	M006	4250.21	7099.258	707.249	480.0	1996-04-09
<input type="checkbox"/>	<input type="checkbox"/>	7	M007	4249.95	7149.795	703.073	425.0	1996-04-23
<input type="checkbox"/>	<input type="checkbox"/>	8	M008	4250.86	7200.874	706.324	409.0	1996-04-30
<input type="checkbox"/>	<input type="checkbox"/>	9	M009	4250.021	7250.971	710.789	410.0	1996-05-10
<input type="checkbox"/>	<input type="checkbox"/>	10	M010	4500.726	7099.169	693.874	500.0	1996-05-18
<input type="checkbox"/>	<input type="checkbox"/>	11	M011	4500.938	7149.709	696.017	500.0	1996-05-27
<input type="checkbox"/>	<input type="checkbox"/>	12	M012	4500.737	7200.416	698.098	425.0	1996-06-05
<input type="checkbox"/>	<input type="checkbox"/>	13	M013	4500.385	7249.337	699.921	500.0	1996-06-15

If the **Ignored** column is ticked, then Leapfrog Geo completely ignores that row, as though it has been deleted. This is useful for suppressing erroneous data from being processed.

If a row in a collar table is ignored, then all other data associated with that hole (e.g. surveys and interval measurements in other tables) are also ignored.

Collar tables have a **trench** column that indicates whether or not the drillhole is from a trench. When the **trench** column is ticked for a drillhole, the trench will be desurveyed in a different manner from other drillholes. See [The Raw Tangent Algorithm](#) for more information.

Cells in a table are editable, apart from the **id** column, which Leapfrog Geo uses as unique identifier. Double-click in a cell to edit it. If the cell you wish to edit is already selected, press the space bar to start editing.

When you edit a cell, the change will be indicated in bold text:

Ignored	trench	id	holeid	x	y	z	maxdepth	Completed
<input type="checkbox"/>	<input type="checkbox"/>	1	M001	3999.231	7499.063	727.169	250.0	1996-03-05
<input type="checkbox"/>	<input type="checkbox"/>	2	M002	4050.39	7500.755	726.926	250.0	1996-03-09
<input type="checkbox"/>	<input type="checkbox"/>	3	M003	4098.904	7500.572	727.68	250.0	1996-03-14
<input type="checkbox"/>	<input type="checkbox"/>	4	M004	4149.058	7501.102	728.876	275.0	1996-03-20
<input type="checkbox"/>	<input type="checkbox"/>	5	M005	4199.59	7499.877	729.739	300.0	1996-03-27

When you save the table, the edited text will no longer be displayed in bold.

The controls in the table toolbar provide quick access to table operations:

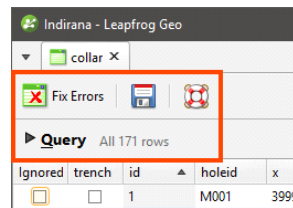

Click on **Fix Errors** to begin correcting errors in the table. See [Correcting Data Errors in Leapfrog Geo](#) and [Handling Special Values](#) below for more information.

Click on **Query** to open up the query editor:

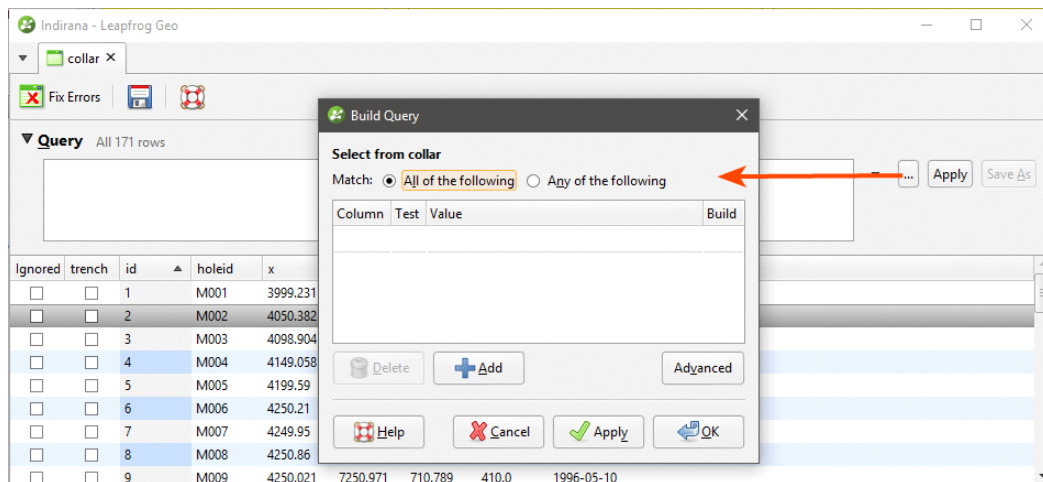

See the [Query Filters](#) topic for more information on how to build and use queries.

With drillhole data, survey tables have **Compatibility** options for changing the desurveying method for the survey table as a whole. See [Drillhole Desurveying Options](#) for more information.

Identifying Errors in Data Tables

Leapfrog Geo automatically identifies and flags common data errors when data tables are imported. In the project tree, there are three ways Leapfrog Geo marks tables that contain conflicts or errors:

- Tables marked with a red X (✖) contain errors that mean data cannot be used for processing. These errors can be corrected by opening the **Errors** window, which is described in [Correcting Data Errors in Leapfrog Geo](#) below.
- Numeric data columns marked with a red X (✖) contain non-numeric values, which means that the rules that are used to handle non-numeric and negative values need to be reviewed. If a table has data that contain non-numeric and negative values, the affected rows cannot be used for further processing until the rules are verified, which is described in [Handling Special Values](#) below.

- Tables marked with a yellow exclamation mark (🚩) contain warnings. Affected rows can be used for further processing, but the information in the warning can indicate that the data requires further attention. For example, if a warning indicates there is data missing for a drillhole defined in the collar table, it may be that a drillhole has been duplicated or that not all required data files have been loaded. Warnings are listed along with table errors in the **Errors** window.

Until errors are corrected, the rows that contain those errors are excluded for all processing that uses the table, including viewing in the scene. For example, if the ID for a collar position contains an invalid coordinate, that collar will not be displayed in the scene as its location is not known. Likewise, any processing will ignore data associated with this drillhole.

It is worth correcting errors as soon as possible, as correcting them later can result in significant recomputation time.

When a table contains errors and warnings, only the errors will be apparent in the project tree view. However, all errors and warnings relevant to a particular table will be displayed in the **Database Errors** window.

There are two approaches to correcting errors in data:

- Correct the data in the primary source. Export the errors as described in [Exporting Data Errors](#) below. Then, when the errors have been corrected, reload the drillhole data as described in [Reloading Drillhole Data](#).
- Correct the data in Leapfrog Geo. If you need a record of corrected errors, first export the errors as described in [Exporting Data Errors](#) below. Then correct errors as described in [Correcting Data Errors in Leapfrog Geo](#).

Exporting Data Errors

If you need a record of corrected errors, first export the errors. This must be done first, as once errors have been corrected in Leapfrog Geo, they cannot be exported, as they no longer exist.

For individual drillhole tables, points tables and structural data tables, export the errors by right-clicking on the table and selecting **Export Errors**. Choose a location where the file will be saved and click **Save**.

To export all errors in the drillhole data set, right-click on the **Drillholes** object and select **Export Errors**. The **Export Drillhole Errors** window will appear:

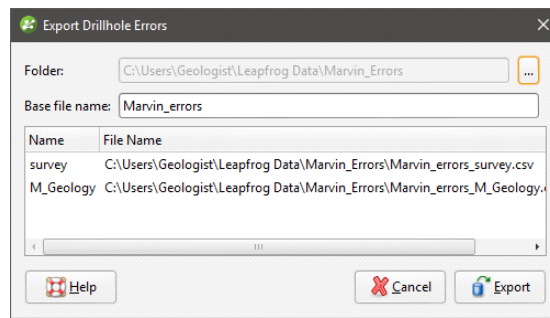

The list shows the files that will be created, one for each table that contains errors. Choose a folder where the files will be saved, then enter a **Base file name**, which will be added to the front of each file name.

Click **Export** to export the error files.

Correcting Data Errors in Leapfrog Geo

If you require a record of the errors in drillhole data, export the errors as described in [Exporting Data Errors](#) above before starting to correct the errors in Leapfrog Geo.

To correct errors in a data table, right-click on the table and select **Fix Errors**. The **Drillhole Errors** window will appear. Leapfrog Geo identifies a range of common errors, and all errors identified in a table are grouped by type. Click on an error type to expand it and see the source of a specific error:

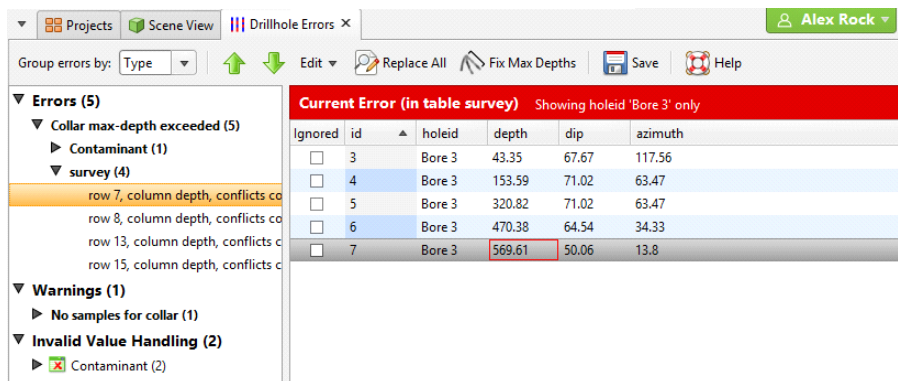

You can change the size of the **Drillhole Errors** window and the columns in the table to view more information easily. When you have finished fixing errors, click the **Save** button (📁). Leapfrog Geo will then update the database.

Errors are automatically grouped by **Type**, but if there are many errors, you may find it useful to view them grouped by **Table** or **HoleID**:

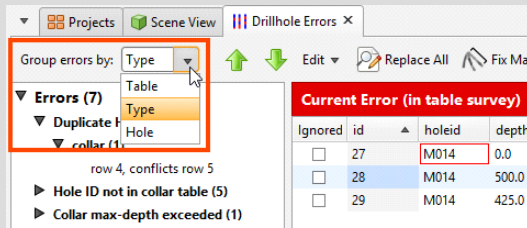

When a row that contains an error is selected, a red box indicates the source of the error. When two rows of data conflict, both rows will be displayed, which may be useful in determining how to fix the error:

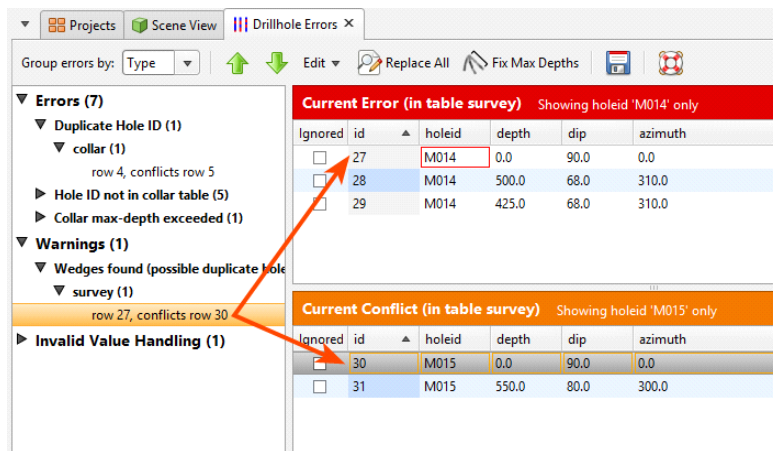

Some typical errors and how to correct them are described in [Common Errors and How to Fix Them](#) below.

Replacing Values in a Column

The **Replace All** button in the toolbar may be useful in correcting any errors without closing the **Drillhole Errors** window. With the **Replace All** button, you can replace an incorrect value that occurs multiple times in a column. To do this, click the **Replace All** button (🔍). Select the **Column** to search and enter the new value:

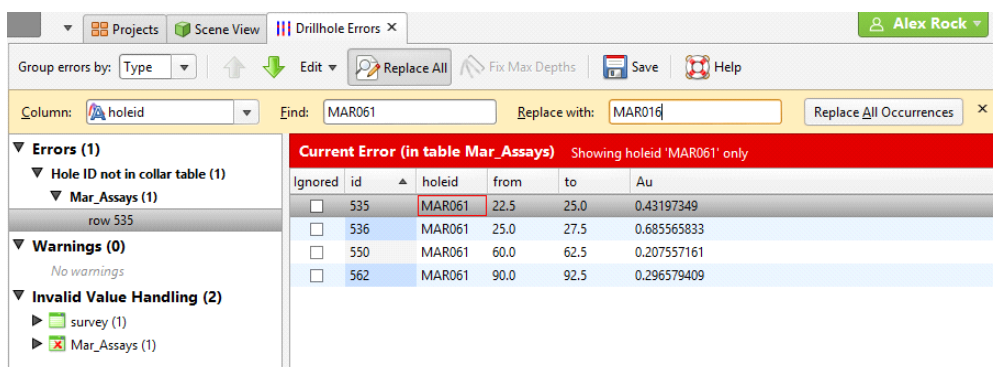

Click **Replace All Occurrences** to make the changes.

You can also select a number of rows and replace values in a selected column with a single value. To do this, use the Shift and Ctrl keys to select the rows you wish to edit, then click the **Edit** button and select **Write to Selected Rows**:

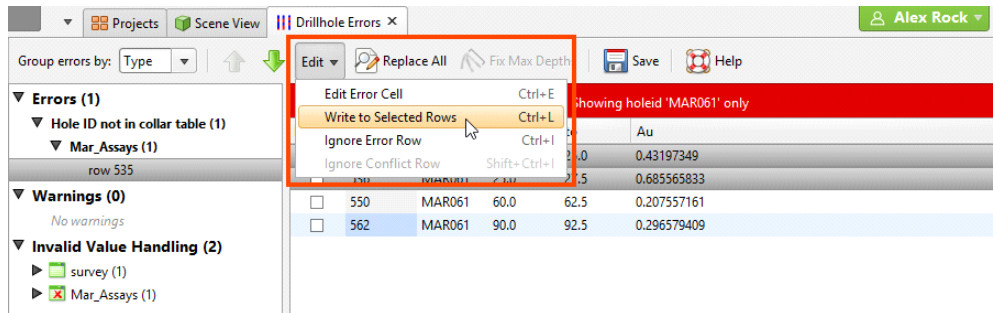

In the fields that appear, enter the **New value**, then click the **Write to Selected Rows** button:

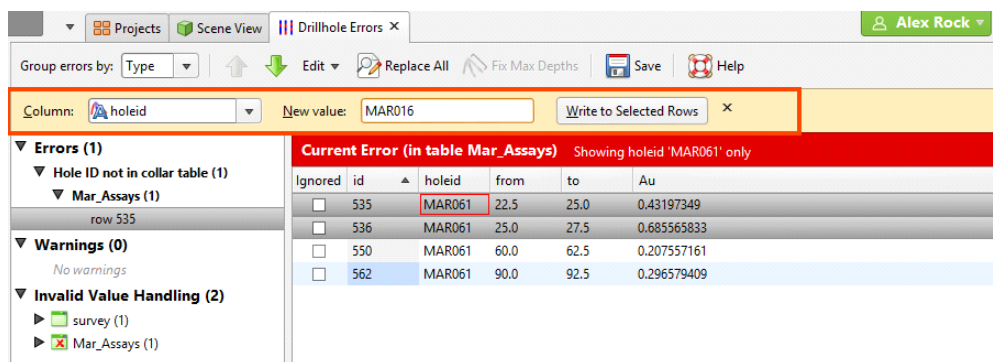

Common Errors and How to Fix Them

There are many possible sources of error in the data itself and you may be able to correct the errors directly in the **Errors** window. With drillhole data, however, the message given in the **Errors** may actually point to an error elsewhere in the dataset, in which case you will need to open the other table from the project tree and edit it directly.

The errors and warnings described are:

- [Duplicate Points Error \(Points Tables\)](#)
- [Duplicate Hole ID Error](#)
- [Hole ID Not in Collar Table Error](#)
- [Collar Max Depth Error](#)
- [Invalid Max Depth Error](#)
- [From Depth Exceeds To Depth Error](#)
- [Overlapping Segments Error](#)
- [No Samples for Collars Warning](#)
- [No Surveys for Collar Warning](#)
- [Wedges Found Warning](#)

Duplicate Points Error (Points Tables)

Points tables will have **Duplicate Points** errors when rows have identical x, y and z values:

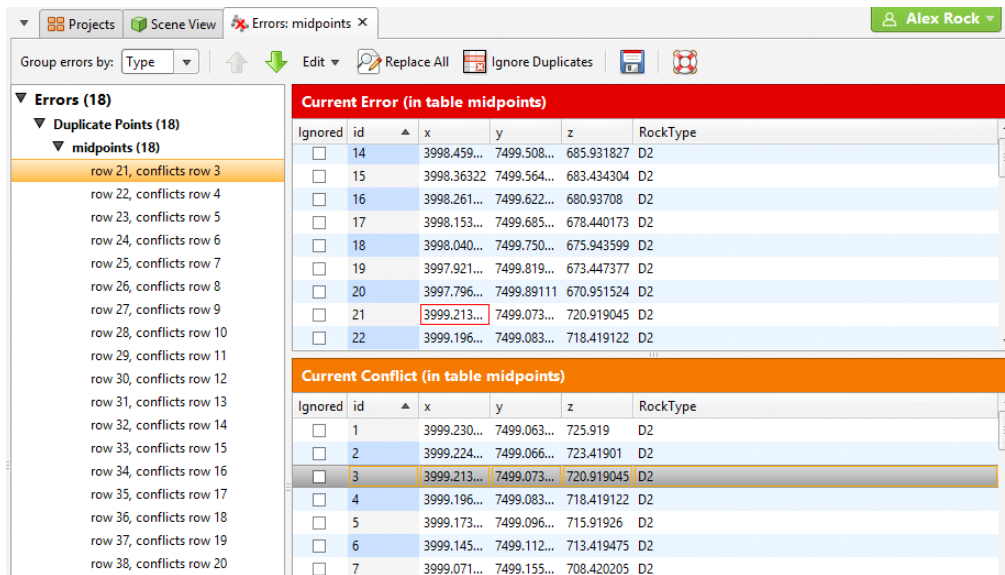

Tick **Ignored** for the rows you wish to ignore. If there are many duplicate points in the table, click the **Ignore Duplicates** button (🗑️). When you save the table, all duplicate rows will be marked as **Ignored**.

Duplicate Hole ID Error

Collar tables will have **Duplicate Hole ID** errors when collars have been assigned the same ID. Here, rows 4 and 5 have the same ID but are clearly different holes:

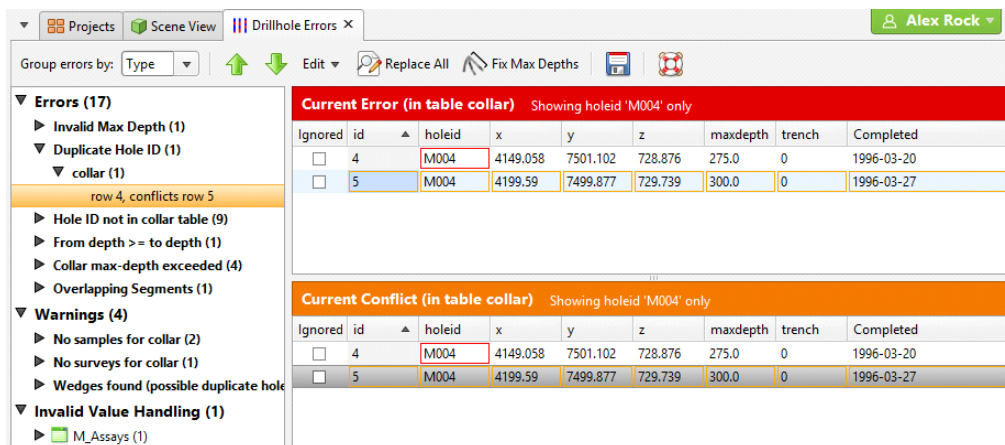

Changing the hole ID for one of the drillholes will correct the error. If the collar has been recorded twice by accident, tick the **Ignored** box for the duplicate collar.

Hole ID Not in Collar Table Error

Interval tables will have **Hole ID not in collar table** errors when the hole ID specified in the interval table is not found in the collar table.

The screenshot shows the 'Drillhole Errors' window with a tree view on the left and a table of errors on the right. The tree view shows a hierarchy of errors, with 'Hole ID not in collar table (10)' expanded to show 'M_Assays (4)'. The table on the right is titled 'Current Error (in table M_Assays) Showing holeid 'M005' only' and contains the following data:

Ignored	id	holeid	from	to	Au
<input type="checkbox"/>	415	M005	0.0	2.5	0.02
<input type="checkbox"/>	416	M005	2.5	5.0	0.02
<input type="checkbox"/>	417	M005	5.0	7.5	0.02
<input type="checkbox"/>	418	M005	7.5	10.0	0.02
<input type="checkbox"/>	419	M005	10.0	12.5	0.132019027
<input type="checkbox"/>	420	M005	12.5	15.0	0.130456449
<input type="checkbox"/>	421	M005	15.0	17.5	0.714647081
<input type="checkbox"/>	422	M005	17.5	20.0	0.734139351
<input type="checkbox"/>	423	M005	20.0	22.5	0.48973995
<input type="checkbox"/>	424	M005	22.5	25.0	0.922992852
<input type="checkbox"/>	425	M005	25.0	27.5	1.570789879
<input type="checkbox"/>	426	M005	27.5	30.0	0.481513287

Affected intervals cannot be displayed. There are two possibilities for fixing this error:

- The collar table uses the wrong hole ID. Edit the collar table to correct the hole ID.
- The interval table uses the wrong hole ID. Use the **Replace All** tool to the incorrect values with the correct one. See [Replacing Values in a Column](#) above.

Collar Max Depth Error

Interval tables will have **Collar max-depth exceeded** errors when the **depth** values in the interval table exceeds the **maxdepth** value defined in the collar table. The **maxdepth** defined in the collar table is often a theoretical value established before drilling. If the **depth** value flagged as an error is not unrealistic, click on the **Fix Max Depths** button (🔧):

The screenshot shows the 'Drillhole Errors' window with a tree view on the left and a table of errors on the right. The tree view shows a hierarchy of errors, with 'Collar max-depth exceeded (1)' expanded to show 'survey (1)'. The table on the right is titled 'Current Error (in table survey) Showing holeid 'M015' only' and contains the following data:

Ignored	id	holeid	depth	dip	azimuth
<input type="checkbox"/>	30	M015	0.0	90.0	0.0
<input type="checkbox"/>	31	M015	550.0	80.0	300.0

This results in the collar table being updated with a maximum depth value that reflects the data in the interval tables.

Invalid Max Depth Error

Collar tables will have **Invalid Max Depth** errors when the **maxdepth** value is negative or non-numeric:

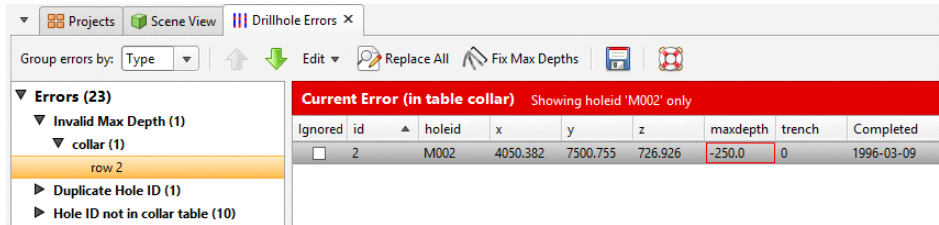

These errors are often the result of data entry mistakes and can be corrected by editing the table in the **Errors** window.

From Depth Exceeds To Depth Error

Interval tables will have **From depth > = to depth** errors when the **from** and **to** values in a row do not make sense:

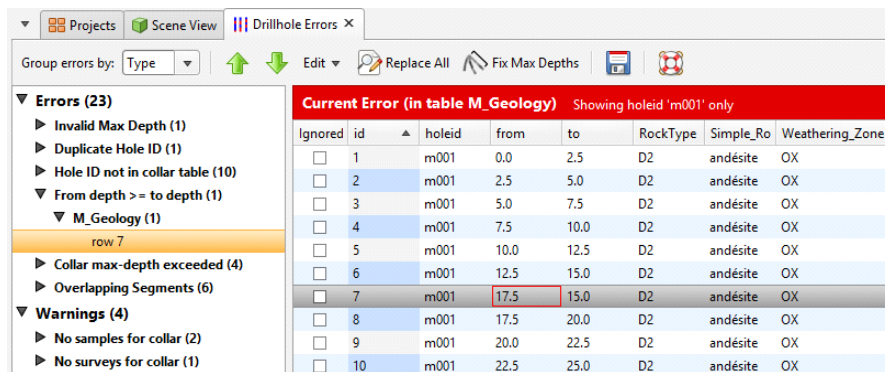

These errors are often the result of data entry mistakes and can be corrected by editing the table in the **Errors** window.

Until the error is corrected, the affected interval cannot be displayed, although all non-conflicting intervals will still be displayed for that drillhole.

Overlapping Segments Error

Interval tables will have **Overlapping Segments** errors when intervals are in the same place for the same hole or when two holes are in the same place. Here, row 12 overlaps row 13 and the error can be corrected in the **Drillhole Errors** window by entering the correct **to** value for row 12:

The screenshot shows the Drillhole Errors window with the following data tables:

Current Error (in table M_Geology) Showing holeid 'm001' only

Ignored	id	holeid	from	to	RockType	Simple_Ro	Weathering_Zone
<input type="checkbox"/>	6	m001	12.5	15.0	D2	andésite	OX
<input type="checkbox"/>	7	m001	17.5	15.0	D2	andésite	OX
<input type="checkbox"/>	8	m001	17.5	20.0	D2	andésite	OX
<input type="checkbox"/>	9	m001	20.0	22.5	D2	andésite	OX
<input type="checkbox"/>	10	m001	22.5	25.0	D2	andésite	OX
<input type="checkbox"/>	11	m001	25.0	27.5	D2	andésite	OX
<input type="checkbox"/>	12	m001	27.5	31.0	D2	andésite	OX
<input type="checkbox"/>	13	m001	30.0	32.5	D2	andésite	OX
<input type="checkbox"/>	14	m001	32.5	35.0	D2	andésite	OX
<input type="checkbox"/>	15	m001	35.0	37.5	D2	andésite	OX
<input type="checkbox"/>	16	m001	37.5	40.0	D2	andésite	OX
<input type="checkbox"/>	17	m001	40.0	42.5	D2	andésite	MX
<input type="checkbox"/>	18	m001	42.5	45.0	D2	andésite	MX
<input type="checkbox"/>	19	m001	45.0	47.5	D2	andésite	MX
<input type="checkbox"/>	20	m001	47.5	50.0	D2	andésite	MX

Current Conflict (in table M_Geology) Showing holeid 'm001' only

Ignored	id	holeid	from	to	RockType	Simple_Ro	Weathering_Zone
<input type="checkbox"/>	5	m001	10.0	12.5	D2	andésite	OX

If an interval has been defined twice, click **Ignored** for one of the rows. Until the error is corrected, the affected intervals cannot be displayed, although all non-conflicting intervals will still be displayed for that drillhole.

No Samples for Collars Warning

Interval tables will have **No values for Hole ID** warnings when there are no values in the interval table that correspond to a collar defined in the collar table. In this example, a hole called M090 has been defined in the collar table, but there is no data for it in the M_Assays table.

The screenshot shows the Drillhole Errors window with the following data tables:

Current Error (in table M_Assays) Showing holeid 'M090' only

Ignored	id	holeid	from	to	Au
---------	----	--------	------	----	----

Warning (4)

- No samples for collar (2)
 - M_Assays (1)
 - No values for Hole ID M090, collar row 16

There are three possibilities:

- There are no values in this interval table for that collar. There is no need to do anything to remedy the warning as it will not affect further processing of the data.
- The collar table uses the wrong hole ID. This may be the case if there is also a **Hole ID not in collar table** warning listed. Edit the collar table to correct the hole ID.
- There are values for that collar in the interval table but they use the wrong collar ID. Again, there may also be a **Hole ID not in collar table** warning listed. Edit the interval table and correct the hole ID for the affected intervals.

No Surveys for Collar Warning

This survey table error is similar to **No Samples for Collars Warning** above: there are no values in the survey table that correspond to a collar defined in the collar table. Check that the collar table and the survey table are using the right hole ID. You will need to edit the survey table or collar table directly before this warning can be cleared.

Wedges Found Warning

Wedges found warnings occur in the collar table or in the survey table when drillholes appear to be duplicates because they are very close together in space.

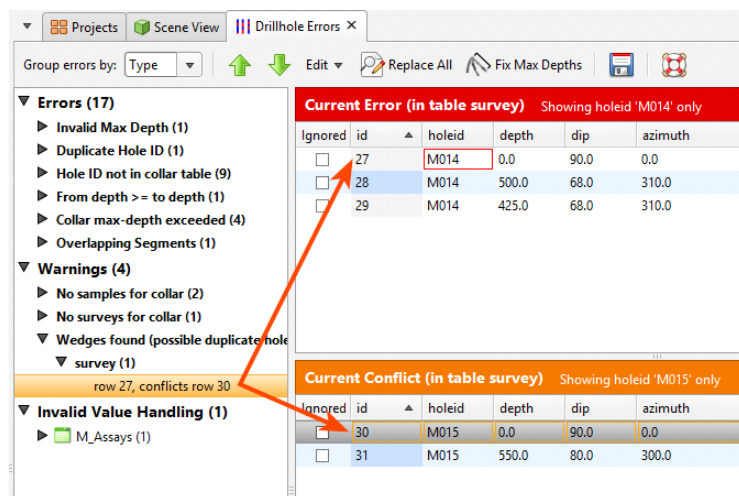

Leapfrog Geo flags drillholes that are less than 1° apart as possible duplicates; if you have two drillholes that are that close together, you may need to adjust the collar location of one of the drillholes to clear the warning. You can do this by editing the collar table.

Handling Special Values

Assay data often contains special values to represent different situations, such as grade values that are below a detection limit, cores that have been lost or segments that were not sampled. In addition, it is not uncommon for a drillhole to contain some intervals that have no values.

When drillhole data tables and points data are imported, Leapfrog Geo will mark columns containing non-numeric special values and missing intervals so that you can review these missing and non-numeric values and determine how Leapfrog Geo will handle them. For example, here numeric data columns that contain errors are marked with a red X:

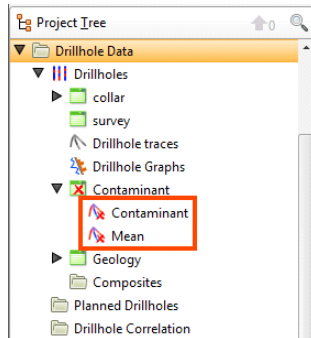

To review these errors, double-click on the column. The **Errors** window will appear with the error displayed for the selected column:

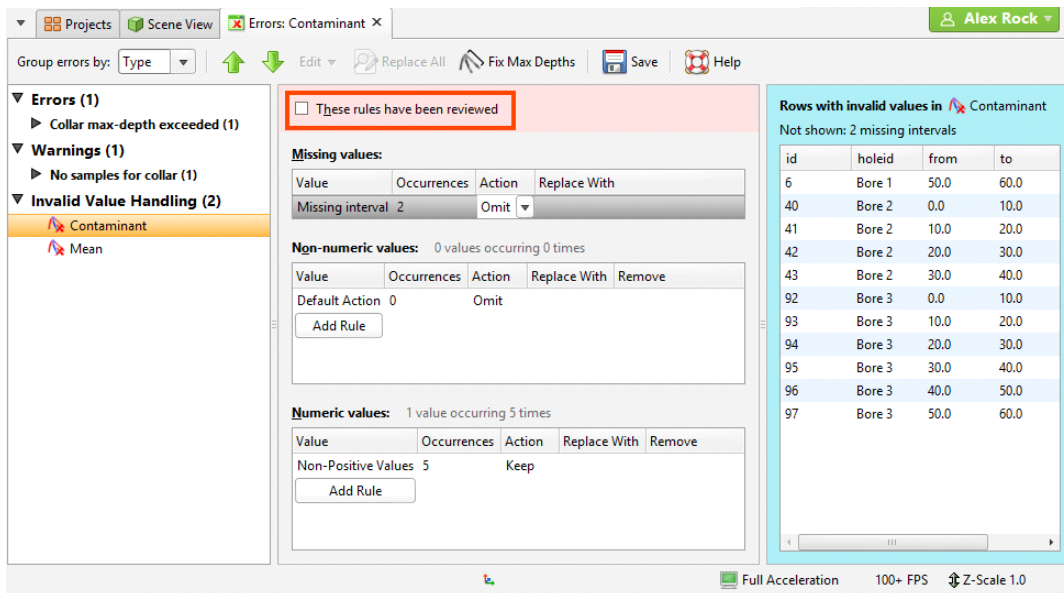

Leapfrog Geo will automatically set missing and non-numeric intervals to be omitted from further processing. Negative values are automatically set to **keep**. To change the **Action**, select another action from the list:

- Select **replace** to enter a numeric value to be used for further processing.
- Select **keep** to use a negative value in further processing.

For non-numeric and negative values, all values are initially treated as a single rule. However, if values have different meanings, you can define specific rules to determine how each value is handled. To do this, click on the **Add Rule** button. The window that appears will show the values present in the data. To define a new rule for a specific value:

- Select that value in the list.
- Tick the box for **The value I want is not in the list**.

- Enter the **Value**.
- Click **OK**.

In the **Invalid Value Handling** window, the value will be listed separately and you can choose the **Action** to apply.

Once you have reviewed the rules that will be applied to the column, tick the **These rules have been reviewed** box and click **OK**. The rules will be applied and used in further processing.

When you open a data table, the original values will be displayed. In all further processing of that data, the assigned special values will be used.

Boundaries

This topic discusses boundaries in Leapfrog Geo. It is divided into:

- [The Clipping Boundary](#)
- [Object Extents](#)
- [Extending a Surface](#)

A newly-created project has only a basic set of X-Y-Z coordinates, and the coordinate system used by the project is determined by the data imported to the project. It is not necessary to specify what coordinate system is used; however, it is necessary to ensure that data you import into the project uses the same coordinate system.

Often the best way to set the coordinates for the project as a whole is to import a map or aerial photo. Adding georeference data to a map will set the location of the map in three-dimensional space and set the coordinates for the project. See [Importing a Map or Image](#) for more information.

An important consideration in defining the project space is setting the clipping boundary. See [The Clipping Boundary](#).

It is not necessary to define a topography to model in Leapfrog Geo, but a defined topography can be used as an upper boundary for all models built in the project. See [Defining a Topography](#).

Part of creating many objects in Leapfrog Geo is defining the basic rectangular boundary that defines the object's extents. See [Object Extents](#).

You can modify the extents of geological models and interpolants using surfaces created from different types of data. See [Modifying a Geological Model's Boundary](#) and [Modifying an RBF Interpolant's Boundary with Lateral Extents](#).

The Clipping Boundary

An important consideration in defining the project space is setting the clipping boundary.

The default clipping boundary in a new project file encompasses everything in the project and grows as more data is added to the project. It is not necessary to set the clipping boundary.

However, the clipping boundary defines the limits of the X-Y coordinates for the region in which

data will be imported and models built and so defines the region in which calculations are made. Restricting the size of the clipping boundary limits the area in which calculations are made and is especially important if you are working with a large dataset.

The best way to set the clipping boundary is using an imported map or aerial photo, as this provides a visual reference that is helpful in working with data added to the project in the future. GIS data or drillhole data can also be used to set the clipping boundary.

To set the clipping boundary, add to the scene the objects you wish to reference in setting the boundary. Right-click on the **Topographies** folder or on the **GIS Data, Maps and Photos** folder and select **Set Clipping Boundary**. The **Set Clipping Boundary** window will be displayed, together with controls in the scene you can use to resize the clipping boundary:

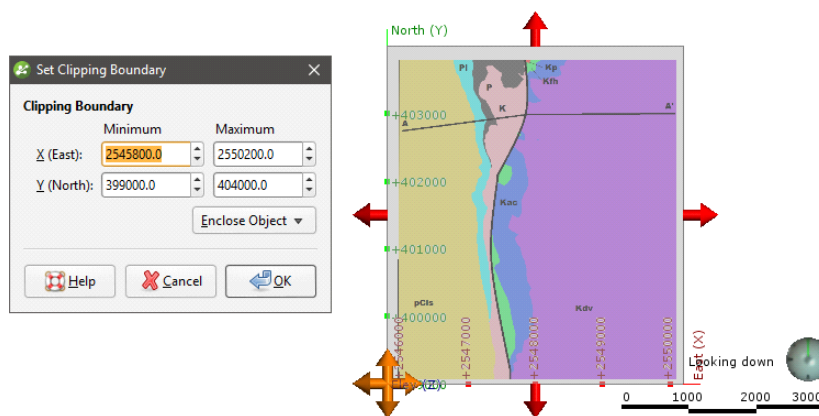

There are three ways to define the rectangular clipping boundary:

- Enter the coordinates.
- Select **Enclose Object** and choose from the list of objects in the project. The clipping boundary will be updated using the selected object.
- Use the controls that appear in the scene. The orange handle adjusts the corner of the clipping boundary and the red handles adjusts its size.

When you have finished adjusting the clipping boundary, click **OK**.

If you are going to import elevation data and use it to create a topography, it is important to set the clipping boundary before creating the topography. For example, here a map has been imported and a topography (yellow) created from an elevation grid. The map is displayed draped on the topography:

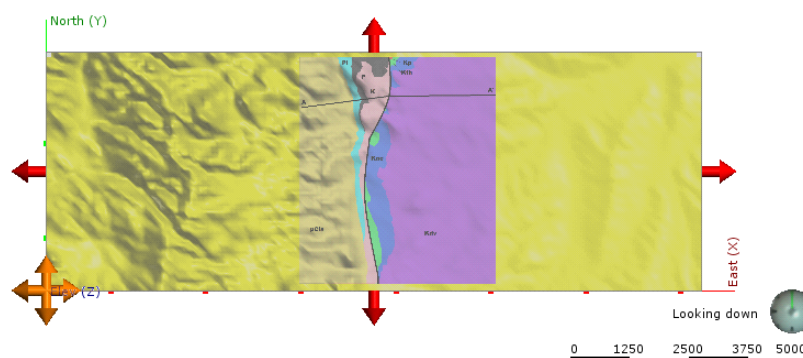

The red arrows and orange handle show the clipping boundary, which has been allowed to expand to encompass all data imported to the project. Because the topography was created before the clipping boundary was set, all the data in the imported elevation grid has been used and the resulting topography is larger than might be practical. Clearly, if the intention is to model within the area on the map, the clipping boundary should be limited to the region indicated by the map.

If the map is the only object in the project, it can easily be used to set the clipping boundary by selecting **<Everything>** from the **Enclose Object** list:

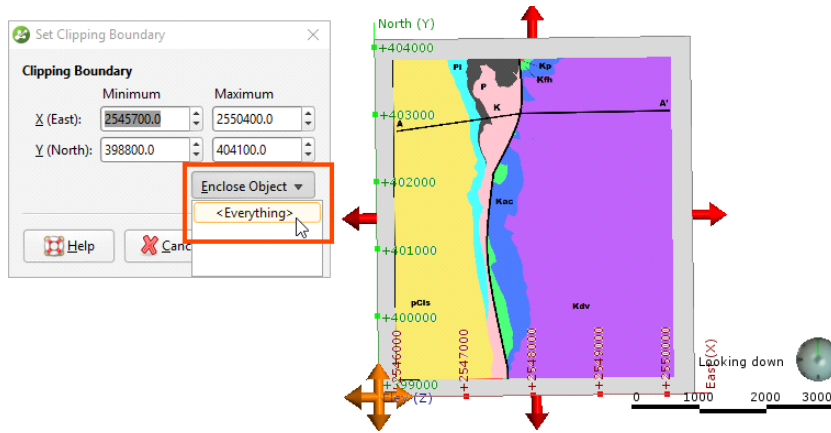

This results in a clipping boundary that is limited to the extents of the map:

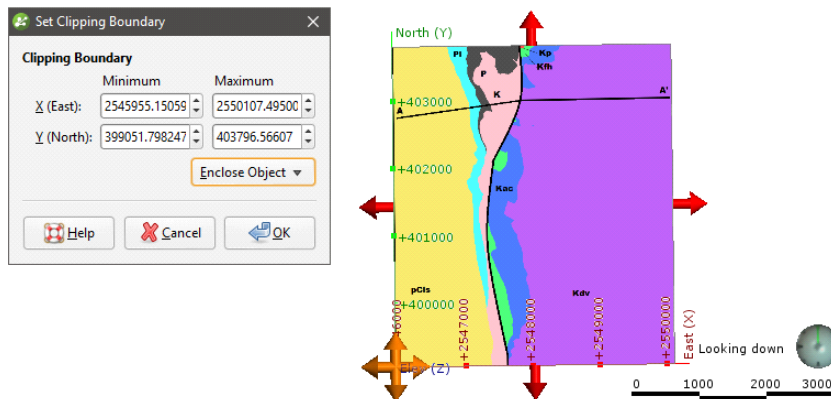

Once the clipping boundary has been set, further data imported into the project will be clipped to it. For example, importing the elevation grid and using it to create a topography only after the clipping boundary has been set to the map extents will result in a topography (with the map draped) that looks like this:

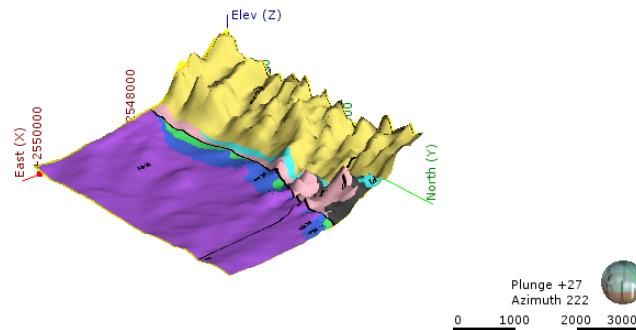

Once the clipping boundary has been set, a good next step is defining the topography. See [Defining a Topography](#).

Object Extents

Part of creating many objects in Leapfrog Geo is defining the basic rectangular boundary that defines the object's extents. There are generally two options for defining an object's extents:

- The first option is to define extents that are independent of other objects in the project. You can do this by entering coordinates or adjusting controls in the scene to set the size and shape of the extents. The new object's extents are fixed to the specified size. This is a good choice if, for example, you are building a geological model from a map and wish to define the model extents based on information on the map.
- The second option is to define extents based on other objects in the project. This is done by selecting the other object from the **Enclose Object** list that appears in many Leapfrog Geo screens.

For both methods, the new object's extents are fixed to the selected size. Using the **Enclose Object** list does not link the two objects; it is simply using the X-Y-Z coordinates of the original object as the basis for the new extents.

For example, here, a geological model's extents could be defined using the lithology segments used as the base lithology:

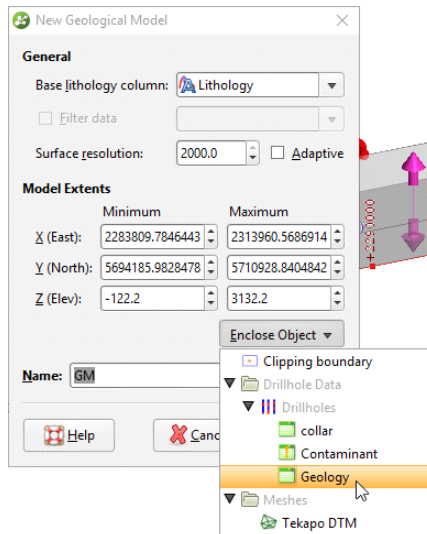

When creating some objects, you have the option of sharing extents with another object. This is the case with editable meshes (🌐), where you can choose whether the mesh has its own extents or shares extents with other objects in the project. Shared extents are updated when the original object's extents are updated.

If you are unsure about relationships between objects, expand them in the project tree to view more information. Here, two meshes have been defined from the same set of points:

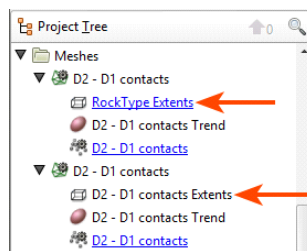

The first mesh shares its extents with another object in the project, which is indicated by the hyperlink. The second mesh has no hyperlink; it has its own extents that are not updated by other objects in the project.

Geological models and interpolants are created with a basic set of rectangular extents that can then be refined by adding extents created from other data in the project. Creating extents is a useful way of restricting modelling to a particular area of interest. For example, modelling can be restricted to a known distance from drillhole data by applying a distance function as a lateral extent. See [Modifying a Geological Model's Boundary](#) for more information.

Extending a Surface

Geological models created in a Leapfrog Geo project automatically use the defined topography as an upper boundary. If a model is defined that extends outside the topography, an error will occur. A similar error occurs when surfaces used in geological models do not extend outside the model's extents. In all cases, Leapfrog Geo cannot process the surface and an error will be displayed.

In this example, an error has occurred during the process of creating a geological model because the topography (yellow) does not enclose the model extents (pink):

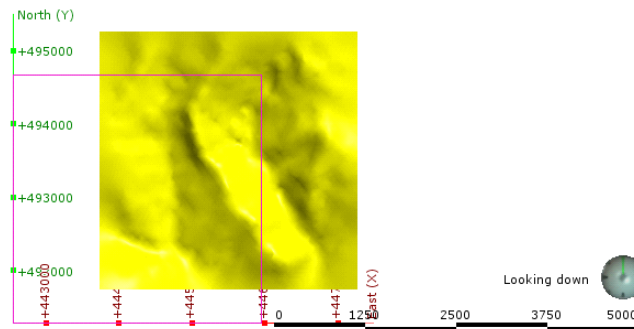

In order for Leapfrog Geo to be able to divide the model into separate volumes, the topography needs to be extended to enclose the model's boundary or the model's boundary needs to be restricted so it falls inside the topography. When the model is processed, the following error results:

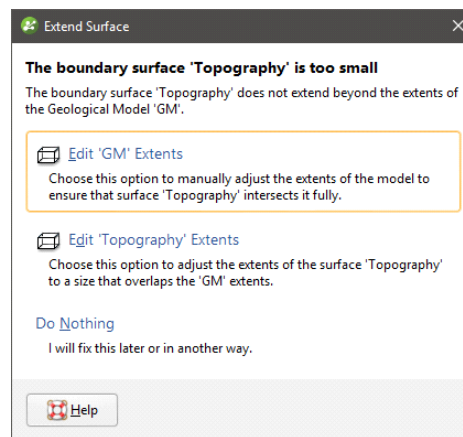

The solutions proposed will depend upon the data used to create the surfaces that conflict, but fall into three broad categories:

- Reduce the size of the model's or interpolant's extents. Click the **Edit Extents** button. This will open the object's **Boundary** window and you can change the boundary.
- Enlarge the topography by manually adjusting it. Click on the **Edit Topography Extents** button. This option is only available when the topography has been created from more than one data source. See [Adding Height Data to the Topography](#) and [Changing Topography Settings](#).
- Use the surface's vertices to create the boundary or contact with extents large enough to be used in the model or interpolant. Click the **Use Vertices** button to create a new vertices object and use it as the source data for the boundary or contact.

If you have a solution to the problem that is not covered by the options presented, click **Do Nothing**. For example:

- If the topography is not large enough, there may be additional data available. If it is not already in the project, import the data and add it to the topography as described in [Adding Height Data to the Topography](#).

- If a surface being used to define a contact surface or boundary in a geological model or interpolant is not large enough, you can add additional data to the surface.

Using vertices to create the boundary or contact results in the creation of a new points object that will be saved in the **Points** folder.

Earlier versions of Leapfrog Geo (up to 1.3) would automatically create the new vertices object and use it to interpolate the surface.

In the case of using topography vertices as an upper boundary, the vertices will be applied as a lateral extent and the defined topography will not be used. For example, here the geological model does not use the defined topography but instead uses the “GM: Topography” surface created from the vertices:

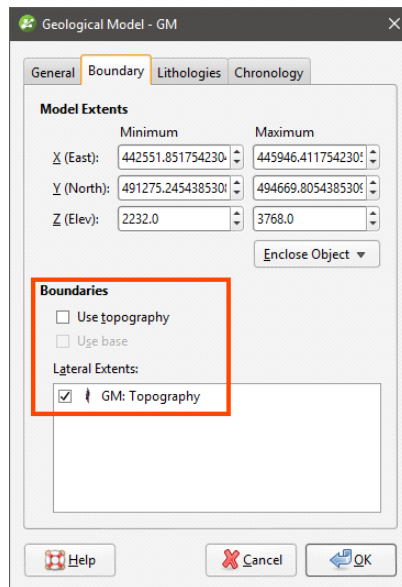

Using topography vertices can take some time to process.

An additional disadvantage to using vertices is that the vertices object created is not linked to the original object. When the object used to create the vertices changes, the vertices will not be updated.

Query Filters

Query filters can be used to select or view a subset of rows in a table. When used on a collar table, this amounts to selecting collars. When used on an interval table, measurement intervals are selected. Query filters can be used to model using a subset of data and to filter information displayed in the scene window.

A query can be created for any type of table in a project, including GIS data, points data and structural data.

When a query filter has been defined for an object and the object is displayed in the scene, the query filter can be applied by clicking on the object in the shape list and selecting the query filter in the shape properties panel:

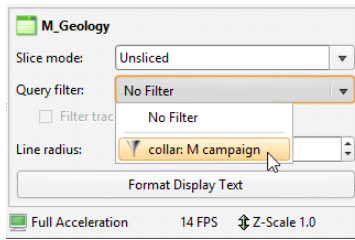

For a drillhole data table, this displays only the data selected by the filter. The trace lines remain displayed in the scene. To filter trace lines, tick the **Filter trace lines** box:

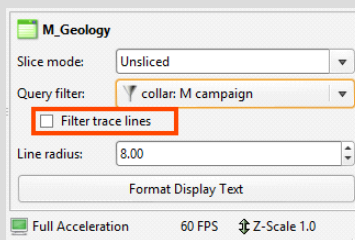

Query filters defined for collar tables are available to all other drillhole data tables.

Creating a New Query Filter

To create a query filter, right-click on the required table in the project tree and select **New Query Filter**. The **Query Filter** window will appear:

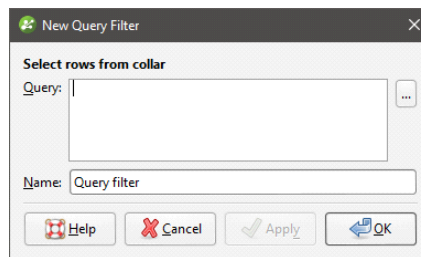

Type the required criteria into the **Query** box, using the query syntax described below. Press Ctrl-Enter for a new line in longer queries. Click the ... button for more advanced query building options, which are described in [Building a Query](#) and [Advanced Queries](#) below.

Assign the filter a name and click **OK** to save it. It will appear in the project tree under the table to which it applies. To apply a query filter to the scene, select the object in the shape list, then select the filter from the **Query filter** list in the shape properties panel:

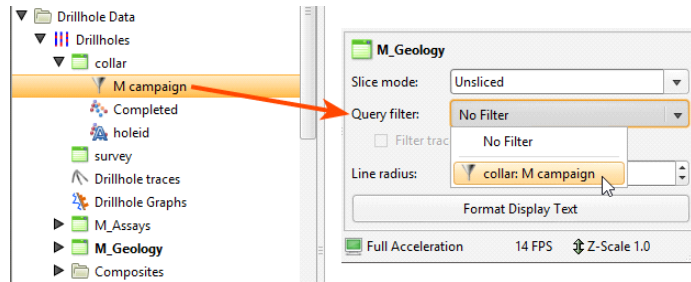

In this case, because the query filter was created for the collar table, it is also available for the lithology table.

Leapfrog Geo Query Syntax

The Leapfrog Geo query syntax is based on the WHERE clause of the Structured Query Language (SQL) with some restrictions:

- Unary operators are not allowed
- SQL functions cannot be used
- The SELECT statement should not be used (as in 'holeid in (SELECT holeid FROM ...)')
- Following statements are also prohibited: CASE, WHEN or MATCH

There is also one main SQL extension:

- IN and NOT IN will accept a partition group for the value list. E.g. 'zone IN layers.weathered' where "layers" is a partition of the "zone" column that has a group called 'weathered'.

These are some examples of valid Leapfrog Geo query statements:

- holeid in ('m-001', 'm-002')
- holeid not in ('m-001', 'm-002')
- holeid not like 'MAR%'

To enter a query that contains an apostrophe, enter two apostrophes. For example, the following query will result in an error:

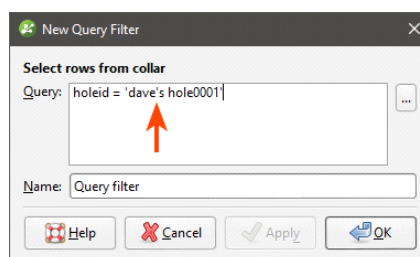

Adding the second apostrophe results in a valid query:

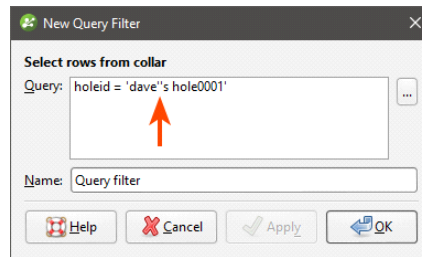

The **Query** box allows the following shortcut queries:

- Typing a single word will match all hole-ids starting with that string. For example, typing "MAR" is a shortcut for "holeid like 'MAR%'"
- Typing a comma-separated list of words will match all hole-ids that exactly match the given words. For example typing "M001, M002" is a shortcut for "holeid in ('M001', 'M002)'".

Building a Query

Many common queries can be built using the **Build Query** window:

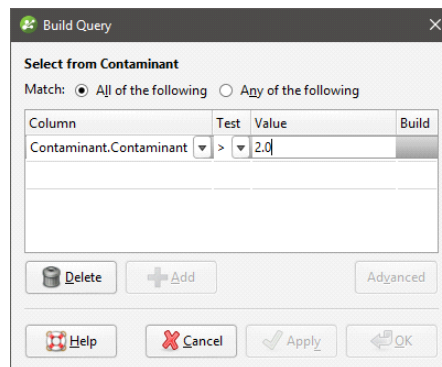

This window aims to be easy to use rather than comprehensive in its support for the full Leapfrog Geo query syntax. For more advanced queries, click on the **Advanced** button. See [Advanced Queries](#) for more information.

To add a criteria, click **Column** to view a list of columns available in the table. Select a **Test** and enter a **Value**. What can be entered for the **Value** depends on the type of column and test selected.

Quotes are not required around text values entered in the value column as they are in SQL. Leapfrog Geo will add quotes and brackets to the value "MX, PM" to make a valid SQL list of strings "('MX', 'PM')" when the query is saved.

Click on the **Apply** button to apply to query to the context in which the dialog was opened.

Use the **Delete** button to delete the criteria in the selected row and the **Add** button to add a blank row.

Advanced Queries

The **Advanced Query** window provides a powerful and flexible query building using the Leapfrog Geo query language.

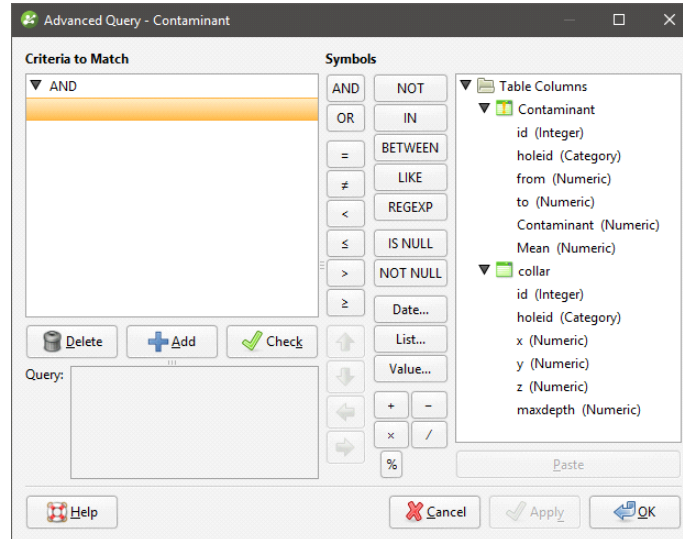

Enter the query in the **Criteria to Match** area on the left. The query is displayed as a tree structure with AND and OR terms as the branch nodes and conditions as the leaves. Use the **Delete** button to delete a row from the query and the **Add** button to add a blank row. The **Check** button can be used at any time to check if the current query statement is valid. Below the buttons is a box showing the raw SQL form of the query.

Except for the arrow buttons, the buttons down the middle of the dialog are used for entering values into the query. The arrow buttons are used for moving the currently selected criteria to a different position in the query. The **Date**, **List** and **Value** buttons will open a builder dialog for the column selected in the current row. If there is no column found or the column is of the wrong type, an error message is displayed.

The tree on the right contains all the columns available to the query. Double-click on a column name to insert it into the query.

Defining a Topography

It is not necessary to define a topography to model in Leapfrog Geo, but a defined topography can be used as an upper boundary for all models built in the project.

A key advantage of defining a topography is that it provides consistent elevation data for objects imported to and created in the project. The quality of elevation information can be poor compared to X- and Y-coordinates, which can create problems when using objects to build a model. A topography can be created from the most reliable elevation data, and other objects can have elevation set from this topography.

An important consideration when defining the topography is ensuring that it is large enough to encompass the models you will be building in the project. If you create a small topography but then later create a model that extends outside the topography, you will need to enlarge the

topography, which can result in considerable reprocessing of all objects in the project that use the topography as a boundary. See [Extending a Surface](#) for more information.

This topic describes creating and working with a topography. It is divided into:

- [Topography From Elevation Grid](#)
- [Topography From Surfaces, Points or GIS Vector Data](#)
- [Fixed Elevation Topography](#)
- [Adding Height Data to the Topography](#)
- [Changing Topography Settings](#)
- [Topography Display Options](#)
- [Projecting Collars onto the Topography](#)

The topography can be created from an imported elevation grid, points data, surfaces and GIS data. It is not necessary to decide on a single source of information, as information can be combined, and you can add and remove data as required.

Once defined, you can export the topography as a mesh or as an elevation grid. See:

- [Exporting Meshes](#)
- [Exporting an Elevation Grid](#)

Topography From Elevation Grid

There are two ways to create the topography from an elevation grid:

- Right-click on the **Topographies** folder and select **New Topography > Import Elevation Grid**. Import the grid as described in [Importing an Elevation Grid](#).
- Import the grid using the **Meshes** folder and then right-click on the **Topographies** folder and select **New Topography > From Surface**.

Enter a name for the topography and click **OK**. A hyperlink to the elevation grid will appear in the **Topographies** folder under the defined topography.

Once the topography has been defined, additional height data can be added by right-clicking on the topography and selecting from the options available. See [See "Adding Height Data to the Topography"](#) for more information.

Topography From Surfaces, Points or GIS Vector Data

To create the topography from a surface, points or GIS data, first import the data into the project.

- Import surfaces into the **Meshes** folder.
- Import drillhole data into the project or points data into the **Points** folder.
- Import GIS vector data into the **GIS Data, Maps and Photos** folder.

Next, right-click on the **Topographies** folder and select one of the **New Topography** options. A list of suitable objects available in the project will be displayed. Select the required object and click **OK**. Enter a name for the topography and click **OK**. A hyperlink to the source object will appear in the **Topographies** folder under the defined topography.

Once the topography has been defined, additional height data can be added by right-clicking on the topography and selecting from the options available. See [See "Adding Height Data to the Topography"](#) for more information.

See also [Changing Topography Settings](#) below.

Fixed Elevation Topography

If you don't have any data suitable for creating a topography, you can set a fixed elevation. To do this, right-click on the **Topographies** folder and select **New Topography > Fixed Elevation**. In the window that appears, enter a value for the elevation and click **OK**. Enter a name for the new topography and click **OK**.

The new topography will appear in the project tree under the **Topographies** folder.

Once a topography has been defined, the only way to set a fixed elevation is to remove the objects that have been used to define the topography. To do this, right-click on the hyperlinked object and click **Remove**. You will then be able to set a fixed elevation for the topography.

Adding Height Data to the Topography

When creating the topography, it is not necessary to decide on a single source of information, as information can be combined. Once the topography has been defined, additional height data can be added by right-clicking on the topography and selecting from the options available:

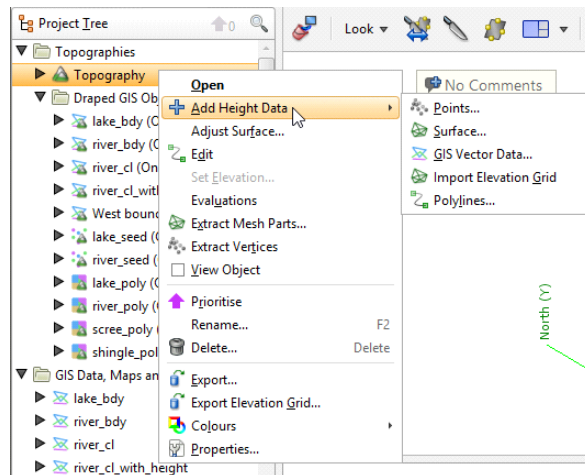

It is not possible to add structural data or polylines with orientation information to the topography. If you edit the topography with a polyline, your options for editing the polyline will be limited.

For points, surfaces and GIS vector data, you will be prompted to select from the data sources available in the project. For an elevation grid, see [Importing an Elevation Grid](#).

All data objects used to define the topography will appear under the topography, hyperlinked to their parent objects:

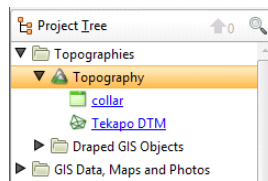

When you have added data to the topography, you may need to enlarge the topography extents. See [Changing Topography Settings](#) below.

To remove data objects from the topography, either:

- Delete the object from the topography. To do this, right-click on the hyperlinked object and click **Remove**.
- Delete the object from the project. If you choose this option, consider carefully the effects on other objects in the project, as once an object is deleted, it cannot be recovered.

When the topography is defined from multiple objects, you can set the resolution of the topography by double-clicking on it. See [Changing Topography Settings](#) below.

Changing Topography Settings

When the topography is created from points or GIS data or when the topography is created by combining data, you can change its boundary and resolution and apply a trend. To do this, double-click on the topography in the project tree. The **Edit Topography** window will appear:

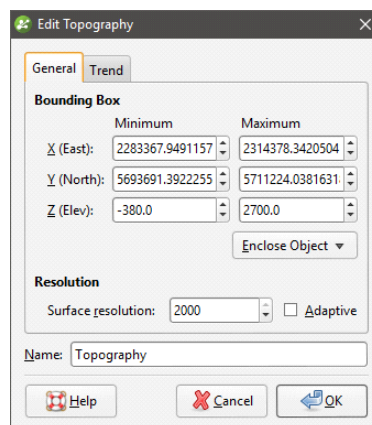

Changing the Size of the Topography

In the **General** tab, you can change the topography extents. Use the controls in the scene or enter the required values in the **Bounding Box** fields.

Topography Resolution

The resolution of the topography depends on how it was created.

- When the topography is created from a single mesh, the resolution of the topography is set from the resolution of the mesh and can only be changed when the mesh is imported. If you wish to change the resolution of the topography, you must first add more height data to the topography. See [Adding Height Data to the Topography](#).
- When the topography is created by setting a fixed elevation, the resolution cannot be set.

When the topography is created from points or GIS data or when the topography is created from combining data, you can set its resolution in the **Edit Topography** window.

When you set a specific **Surface resolution** without enabling the **Adaptive** option, the triangles used will be the same size for the whole topography. When you enable the **Adaptive** option, the resolution of the topography will be affected by the availability and density of real data. See [Surface Resolution in Leapfrog Geo](#) for more information on these settings.

Applying a Trend to the Topography

In the **Trend** tab, you can apply a trend to the topography:

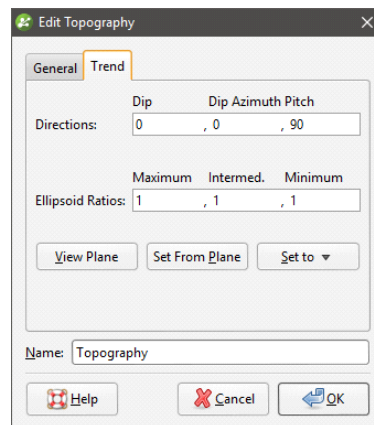

See [Global Trends](#) for more information.

Topography Display Options

To display the topography in the scene window, either:

- Right-click on the topography in the project tree and select **View Object**.
- Click on the topography object and drag it into the scene.

The topography will be displayed in the scene window and in the shape list:

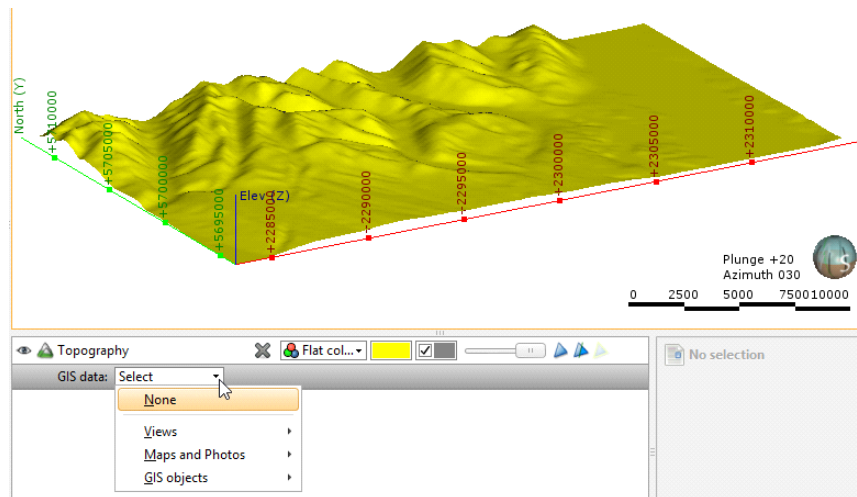

The topography object in the shape list provides additional controls that can be used to change the way the topography is displayed and highlight features of interest. For example, selecting an imported map from the list results in it being displayed draped onto the topography:

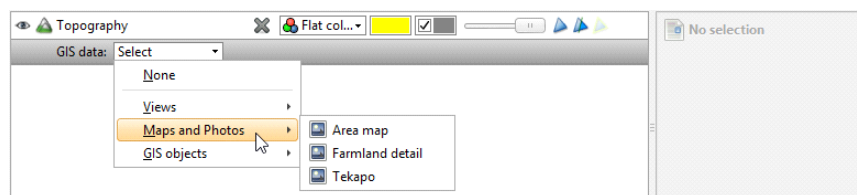

The list is organised into:

- **Views.** This contains options for creating and editing custom topography views and also lists any views already defined. With custom topography views, you can view multiple GIS objects, maps and contours. See [Custom Topography Views](#) for more information.
- **Maps and Photos.** This lists all images stored in the **GIS Data, Maps and Photos** folder.
- **GIS objects.** This lists all GIS data objects stored in the **GIS Data, Maps and Photos** folder.

Projecting Collars onto the Topography

If the collars are not lying on the topography, Leapfrog Geo can make adjustments to the collar depth values so that the collars lie on the topography. This adjustment is reversible.

To make this adjustment, right-click on the collars table and tick the box for the **Project Collars Onto Topography** option. If you then open the collar table, the depth values will reflect the topography. Right-click on the collar table and untick the box for **Project Collars Onto Topography** to return to the uncorrected collar depth values.

GIS Data, Maps and Images

Often the first data imported into a new project is information that sets the coordinates for the project as a whole. This includes GIS data, maps, aerial photos and 2D grids. This section describes importing and working with GIS data and images.

You can view the attribute table for most GIS data objects by right-clicking and selecting **Attribute Table**. You can also create query filters that can be used when displaying the GIS object. See the [Query Filters](#) topic for more information.

If, during the course of a project, GIS data changes, it can be reloaded and models that are dependent on that data will automatically be updated.

Displaying GIS Data

In Leapfrog Geo, there are three ways of viewing GIS data:

- In its "native" form, as it was imported to the project. Add the GIS data object to the scene as you would any other object.
- On the topography. GIS data objects added to a project are automatically projected onto the topography and saved in the **Topographies > Draped GIS Objects** folder. Add the draped GIS object to the scene.
- Combined with other data draped on the topography. See [Custom Topography Views](#) below.

The reason for having different ways of displaying GIS data is the difficulty posed by inconsistent height data. Not all height data is correct or wanted. In practice, it is important for all the data to be consistent. For this reason, a single elevation field is defined as part of the topography and available data is assigned heights from this object. The native height information is available and can be used to define the height of layers in the models.

Custom Topography Views

In Leapfrog Geo, topography can be displayed with any of the GIS data and images available in the project. With a custom view, you can display multiple GIS data objects, maps and aerial photos.

To create a custom view, add the topography object to the scene. Select **Views > Edit views** from the **GIS data** list:

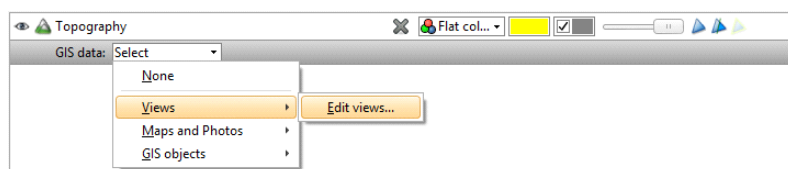

The **Edit GIS Views** window will appear. Click **New** to create a new view. Enter a name for the new view and click **Create**:

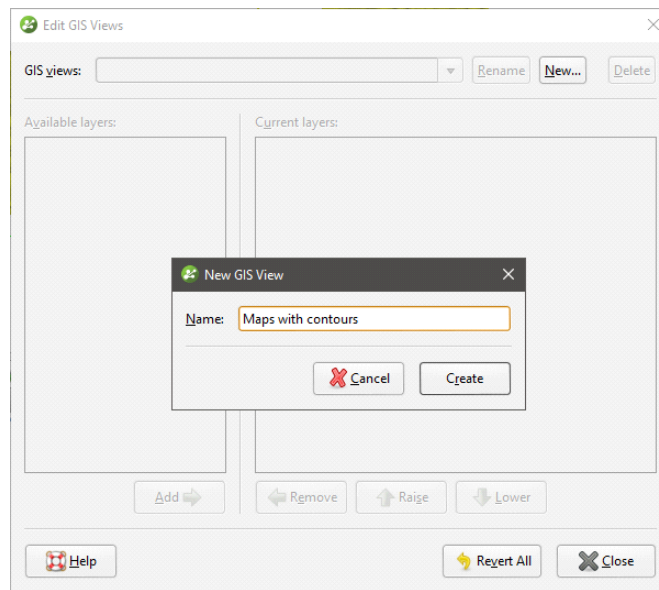

The new view will be created in the **Edit GIS Views** window, together with a list of **Available layers**. Click the **Add** button to move layers into the **Current layers** list and use the **Raise** and **Lower** buttons to arrange them:

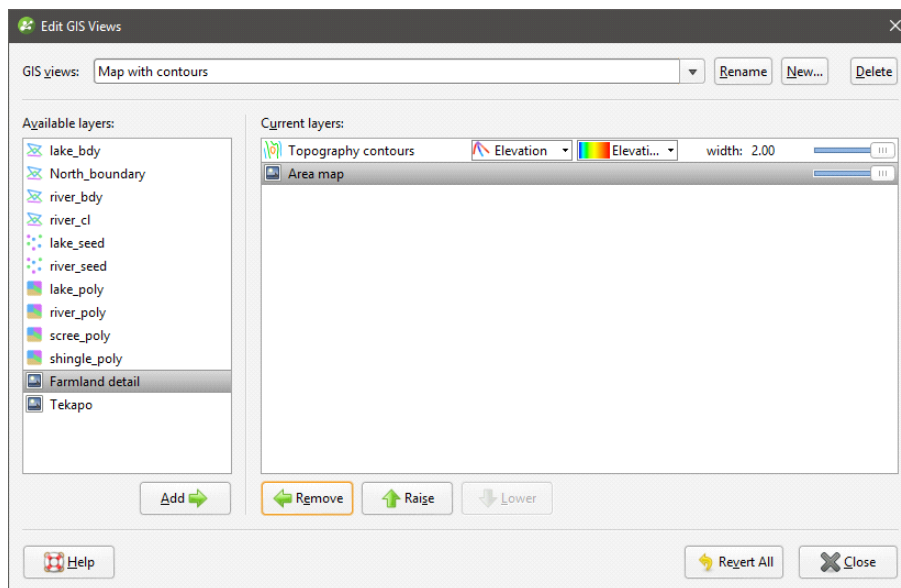

Use the transparency and point and line size controls to emphasise data.

Click **Close**. The topography will be displayed in the scene with the new view applied:

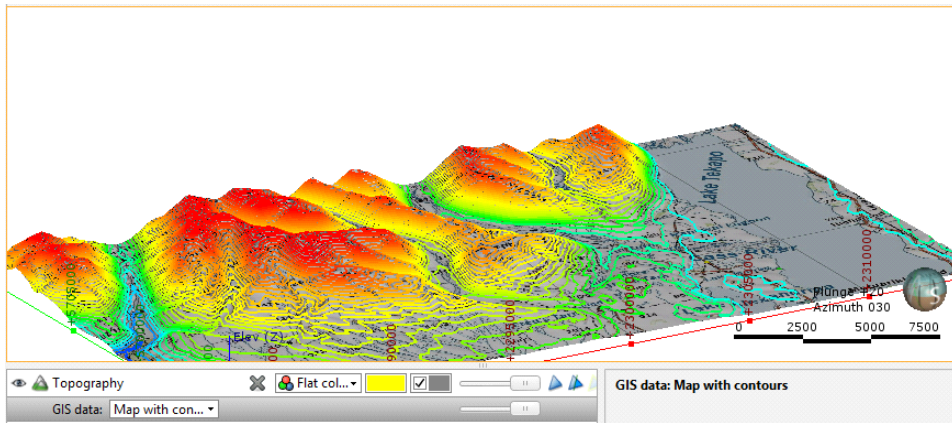

Importing Vector Data

Vector data formats Leapfrog Geo supports include:

- Shape Files (*.shp)
- MapInfo Files (*.tab, *.mif)
- ESRI Personal GeoDatabase Files (*.mdb, *.acddb)

You can also import data from MapInfo and ESRI databases. See [Importing a MapInfo Batch File](#) and [Importing Data from an ESRI Geodatabase](#) for more information.

To import vector data, right-click on the **GIS Data, Maps and Photos** folder and select **Import Vector Data**. Navigate to the folder that contains the GIS data and select the file. You can select multiple files using the Shift and Ctrl keys.

Click **Open** to begin importing the data.

If you are importing a single file, the **Import GIS Vector Data** window will show a summary of the data in the selected file:

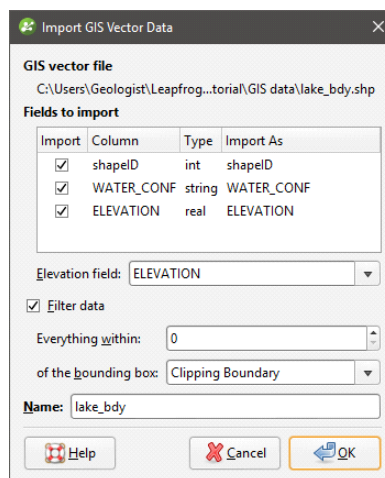

You can choose what field in the data to use for the **Elevation Field** from the list.

If you are importing multiple files, all files being imported are listed in the **Import GIS Vector Data** window and no summary of each file is displayed:

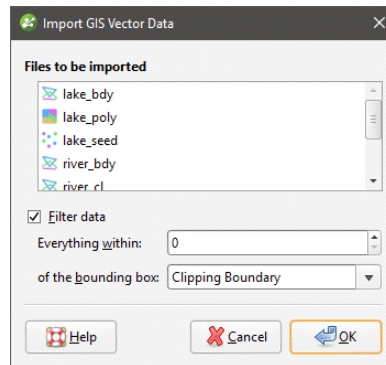

Data is automatically clipped to the clipping boundary, but you can change how the data is filtered to suit any bounding box that exists in the project. If you do not wish to clip the data, untick the **Filter data** box.

Click **OK** to add the data to the project. The object or objects will appear in the project tree under the **GIS Data, Maps and Photos** folder. If a topography has been defined for the project, the imported GIS data objects will automatically be projected onto the topography and saved in the **Topographies > Draped GIS Objects** folder.

You can then view an object's attributes by right-clicking on it and selecting **Attribute Table**.

When importing files, you may be prompted to select whether or not to filter elevation data. If you wish to use another data source for your elevation data, select **Filter data**. For example, if you import a GIS line that has suspect elevation data, you can discard the elevation data and set the elevation from the topography, as described in [Setting Elevation for GIS Objects and Images](#).

If data changes outside the project, it can be reloaded as described in [Reloading GIS Data](#).

Importing a MapInfo Batch File

You can import a collection of GIS data exported from MapInfo. The MapInfo file can include points, lines, polygons, images and elevation grids.

To import GIS data in this way, right-click on the **GIS Data, Maps and Photos** folder and select **Batch Import > from MapInfo**. In the window that appears, navigate to the folder that contains the MapInfo batch file, which is an XML file. Click **Open**.

The data that can be imported will be displayed and you can select which files to import:

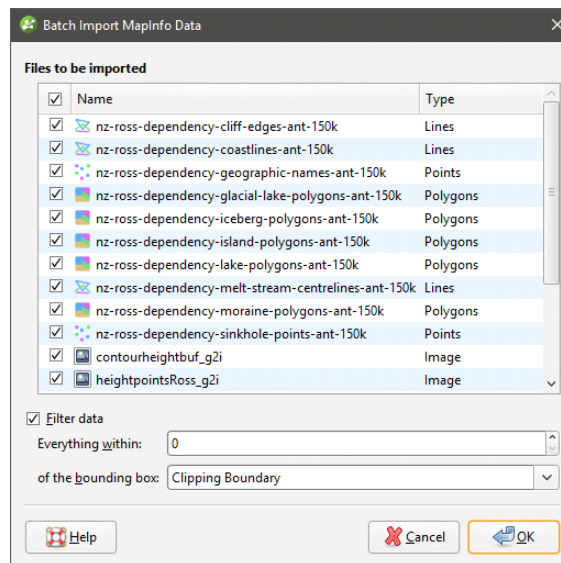

You can select multiple files using the Shift and Ctrl keys.

Data is automatically clipped to the clipping boundary, but you can change how the data is filtered to suit any bounding box that exists in the project. If you do not wish to clip the data, untick the **Filter data** box.

Click **OK** to import the selected files, which will be added to the **GIS Data, Maps and Photos** folder as a group (📁), with the exception of elevation grids, which will be added to the **Mesher** folder.

Points, lines and polygons can be reloaded on an individual basis, which is described in [Reloading GIS Data](#).

Importing Data from an ESRI Geodatabase

You can import points, lines and polygons from an ESRI geodatabase. However, the import of raster data is not supported.

To import GIS points, lines and polygons in this way, right-click on the **GIS Data, Maps and Photos** folder and select **Batch Import > from ESRI Geodatabase**. In the window that appears, navigate to the folder that contains the database and click **Open**.

Leapfrog Geo imports uncompressed ESRI geodatabases.

The data that can be imported will be displayed and you can select which files to import:

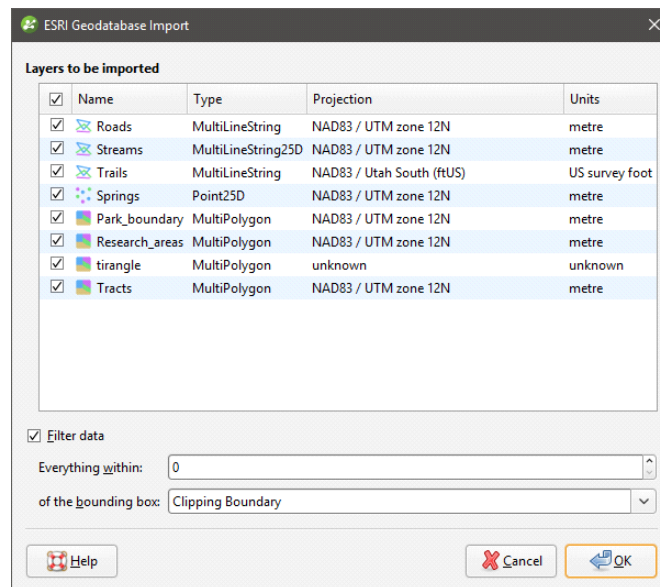

You can select multiple files using the Shift and Ctrl keys.

Data is automatically clipped to the clipping boundary, but you can change how the data is filtered to suit any bounding box that exists in the project. If you do not wish to clip the data, untick the **Filter data** box.

Click **OK** to import the selected files, which will be added to the **GIS Data, Maps and Photos** folder as a group (🗂️). Data in the group can be reloaded individually or as a group, which is described in [Reloading GIS Data](#).

Reloading GIS Data

If during the course of a project GIS points, lines and polygons change, they can be reloaded and dependent models will automatically be updated. Objects originally imported as part of an ESRI database (🗄️) can be reloaded individually or as part of the group.

Although the GIS data will be overwritten, any elevation data set in Leapfrog Geo will be retained.

Reloading Points, Lines and Polygons

To reload a GIS point, line or polygon, right-click on it in the project tree and select **Reload Data**. Navigate to the folder containing the GIS file and select the file. Click **Open**.

The process is the same as importing GIS data. Click **OK** to reload the data. The original data will be overwritten and dependent objects will be updated to reflect the new data.

Reloading an ESRI Database

To reload an ESRI database, right-click on it in the project tree and select **Reload Data**. In the window that appears, select the layers to reload, then click **OK**.

Points, lines and polygons imported as part of an ESRI database can also be reloaded on an individual basis.

2D Grids

Leapfrog Geo imports the following 2D grid formats:

- Arc/Info ASCII Grid (*.asc, *.txt)
- Arco/Info Binary Grid (*.adf)
- Digital Elevation Model (*.dem)
- Intergraph ERDAS ER Mapper 2D Grid (*.ers)
- ESRI .hdr Labelled Image (*.img, *.bil)
- SRTM .hgt (*.hgt)
- Surfer ASCII or Binary Grid (*.grd)

2D grids can also be imported from MapInfo files. See [Importing a MapInfo Batch File](#) for more information.

To import a 2D grid, right-click on the **GIS Data, Maps and Photos** folder and select **Import 2D Grid**. Navigate to the folder that contains grid and select the file. Click **Open** to begin importing the data.

The **Import 2D Grid** window will appear, displaying the grid and each of the bands available. Select the data type for each band and set the georeference information, if necessary. See [Importing a Map or Image](#) for information on georeferencing imported files.

Once the grid has been imported, you can set its elevation, which is described in [Setting Elevation for GIS Objects and Images](#).

When you display the grid in the scene, select the imported bands from the shape list:

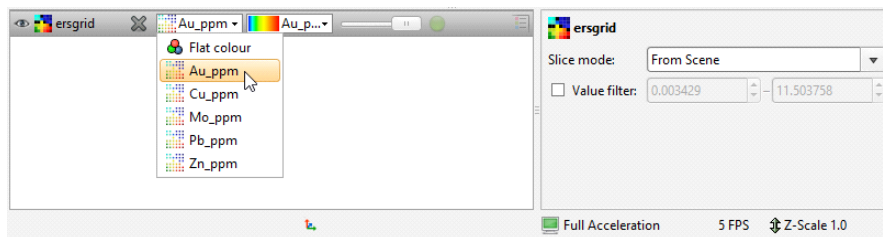

Grids can be displayed as points (●) or as cells and the values filtered, as described in [Displaying Points](#).

Importing a Map or Image

Image formats Leapfrog Geo supports include:

- PNG Files (*.png)
- JPEG Files (*.jpg, *.jpeg)
- TIFF and GeoTIFF Files (*.tiff, *.tif)
- Windows Bitmap Files (*.bmp)
- Graphics Interchange Format Files (*.gif)

Images larger than 16384 by 16384 pixels will be scaled down. Reducing your images in size below this limit will avoid scaling; you can do this by cropping the image during the import process or by scaling down the image in an external image editor.

If the file contains georeference information, it too will be imported.

To import a map or image, right-click on the **GIS Data, Maps and Photos** folder and select **Import Map**. Navigate to the folder that contains the image and select the file. The **Import Image** window will be displayed:

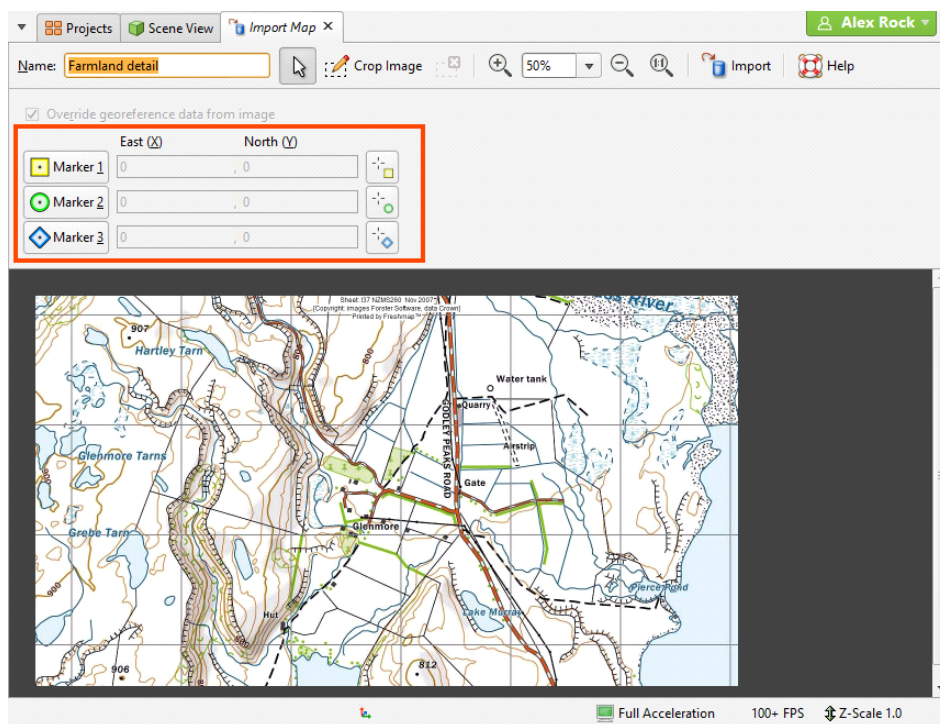

The rest of this topic describes georeferencing images. It is divided into:

- [Manual Georeferencing](#)
- [Automatic Georeferencing](#)
- [Exporting a Georeferenced Image](#)

Adding georeference data to a map will set the location of the map in the three-dimensional viewer. It is often used as a first step in setting the coordinates for the project as a whole.

The three reference markers (📍, 🟢, 🔵) are used to set coordinates for the image in the scene. If the image is the first object added to the project, this will, in effect, set the coordinate system for the project. The scene markers (📍, 🟢, 🔵) let you copy georeference information from the scene.

Cropping the image to only the area of interest will reduce video RAM usage and may improve graphics performance. To crop the image, click on the **Crop Image** button (📏) at the top of the window, then drag around the part of the image you wish to use. Click on the **Remove Crop** button (🗑️) to clear the cropping.

Manual Georeferencing

If the image does not contain georeference information, you will need to add it manually by adding the three reference markers (📍, 🟢, 🔵) to the image. To select a marker, click on its marker button (**Marker 1**, **Marker 2** or **Marker 3**), then move it to the required location on the image using the mouse or the arrow keys.

Once each marker is correctly positioned, enter the real-world X and Y coordinates for each marker:

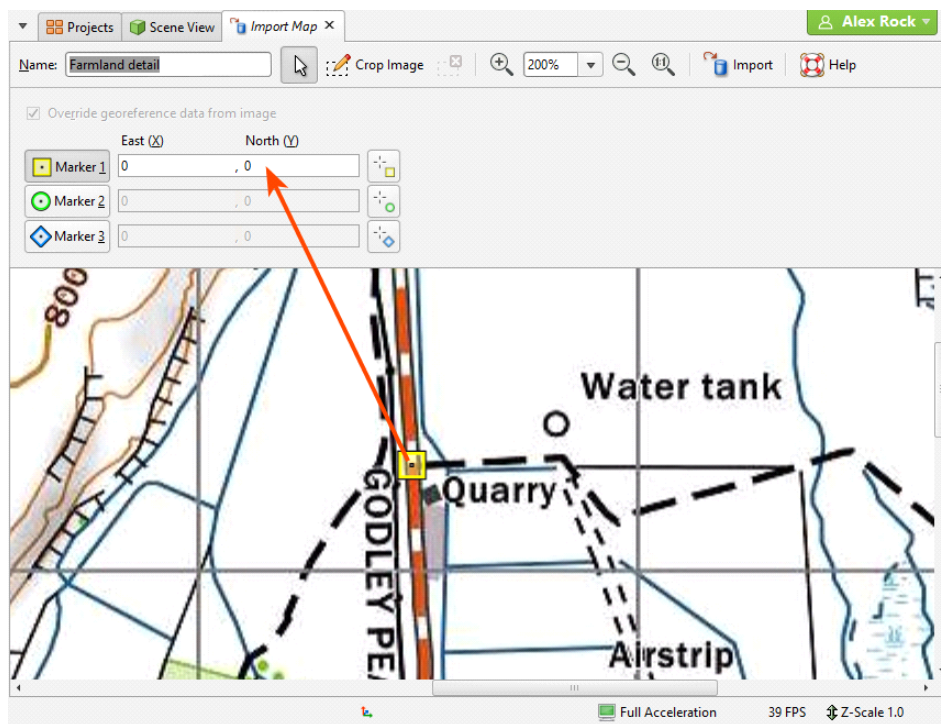

There are two ways to do this:

- Enter the coordinates for each marker in the **East (X)** and **North (Y)** fields. As you enter the coordinates, the positions of the markers will be displayed in the scene.
- Copy coordinates from the scene using the three scene markers (📍, 🟢, 🔵).

The second method is useful when you already have other objects correctly georeferenced in the project. For example, if you have a larger map in the project and wish to import a more detailed map, you can copy the coordinates from the georeferenced map to the detailed one. To do this, move the **Import Map** tab so you can see enough of the scene to work in both windows. Next:

- In the **Import Map** tab, position the marker (📍, 🟢, 🔵) on the image being imported.
- Click the corresponding copy coordinates marker (📍, 🟢, 🔵).

- Zoom in to the point in the scene window where you wish to place the marker and click.

The coordinates in the scene will be copied to the **Import Map** tab.

Once you have set the coordinates for each marker, click **OK** to return to the main window.

Once Leapfrog Geo saves the image, it will appear in the project tree under the **GIS Data, Maps and Photos** folder.

Automatic Georeferencing

If the image contains georeference data, it will automatically be displayed. If the georeference data in the imported image uses a different coordinate system than that used for the project, you can change the georeference data by ticking the **Override georeference data from image** box, then editing the information.

Click **OK** to import the image. It will appear in the project tree under the **GIS Data, Maps and Photos** folder.

Exporting a Georeferenced Image

Leapfrog Geo exports georeferenced images as GeoTIFFs. To do this, right-click on it in the project tree and select **Export**. You will be prompted for a filename and location. Click **Save**.

Setting Elevation for GIS Objects and Images

You can set the elevation for GIS objects and images by:

- Using a fixed elevation
- Using the elevation data from one of the object's attributes
- Using the elevation data from a surface in the project

The options available depend upon the type of object.

	Fixed Elevation	From Attribute	From Surface
GIS lines	X	X	X
GIS points	X	X	X
2D grids	X	-	X
GIS lines drawn in Leapfrog Geo	X	-	-
GIS lines extracted from polylines	X	-	X
Images	X	-	-

To set the elevation for a GIS object or an image, right-click on it in the project tree and select **Set Elevation**. The **Set Elevation** window will appear, displaying the available options. Select the option required and click **OK**.

Creating a New GIS Line

There are three ways to create a new GIS lines object in Leapfrog Geo:

- If you do not have GIS data for a topographical feature you wish to use in model building, you can draw a new GIS line. See [Drawing a New GIS Line](#)
- If you have two surfaces that intersect, you can generate a new GIS line from their intersection. You can use any surface in the project, including those that are generated in building models. See [Creating a New GIS Line from Intersecting Meshes](#).
- If you have a polyline you wish to use as a GIS lines object, right-click on it in the project tree and select **Extract GIS Line**. The new GIS line () will appear in the **GIS Data, Maps and Photos** folder. It is not linked to the original polyline.

To view new GIS line draped on the topography, select the object from the **GIS data > GIS objects** list, as described in [Topography Display Options](#).

Drawing a New GIS Line

GIS lines can be drawn on the slicer or on a surface.

Right-click on the **GIS Data, Maps and Photos** folder and select **New GIS Line > From New Drawing**. In the window that appears, enter a name for the new object and click **OK**.

The object will be created in the project tree and added to the shape list. The scene view will change to view the objects in the scene from above and tools for drawing polylines will appear. Click on the **Draw lines** button (📏) and start drawing in the scene, as described in [Drawing in the Scene](#).

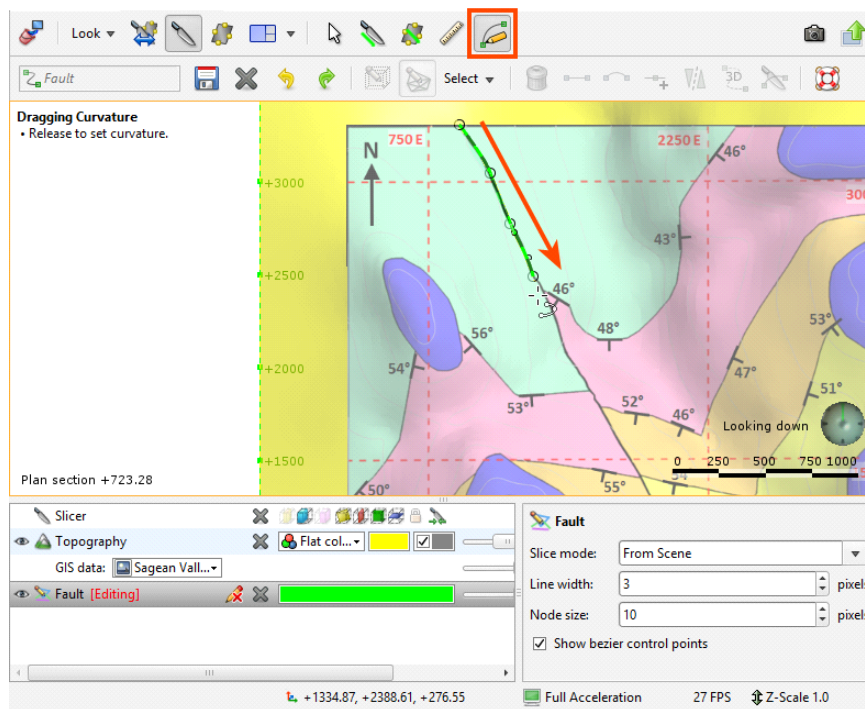

When you have finished drawing, click the **Save** button (💾). The new line (📏) will be saved in the project tree.

You can edit the GIS line by right-clicking on it in the project tree and selecting **Edit**. If it is in the shape list, you can edit it by clicking on the **Edit** button (📏).

Creating a New GIS Line from Intersecting Meshes

You can create a new GIS line from two intersecting meshes. You can use any surface in the project, including those that are generated in building models.

To create a new GIS line from two intersecting meshes, right-click on the **GIS Data, Maps and Photos** folder and select **New GIS Line > From Intersecting Meshes**. In the window that appears, select the meshes to use, enter a name for the new object and click **OK**.

The new line (📏) will be saved in the project tree. It is not linked to the meshes used to create it and will not be updated when the meshes are updated.

Exporting GIS Data

To export GIS data, right-click on the GIS data object in the **GIS Data, Maps and Photos** folder and select **Export**. The **Export GIS** window will be displayed:

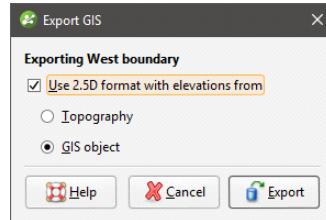

Select whether elevation information will come from the topography or from the GIS object itself, or untick the **Use 2.5D format with elevations from** box to export the object without elevation information.

Click **Export**. You be prompted for a filename and location.

Drillhole Data

Drillhole data forms the basis for creating models in Leapfrog Geo. Because drillhole data often contains errors that reduce the reliability of a model, Leapfrog Geo has tools that help you to identify and correct errors and work with the data.

Drillhole data defines the physical 3D shape of drillholes. It is made up of:

- A collar table, containing information on the location of the drillhole.
- A survey table, containing information that describes the deviation of each drillhole.
- At least one interval table, containing information on measurements such as lithology, date or any numeric or textual values. An interval table must also include collar IDs that correspond to those in the collar table and sample start and end depth.

If you have the Hydrogeology module, a screens table can also be imported.

When a project is first created, the only options available via the **Drillhole Data** folder are for importing data. See [Importing Drillhole Data](#) for more information on these options.

Once data has been added to the project, a **Drillholes** object will be created that serves as a container for the tables imported:

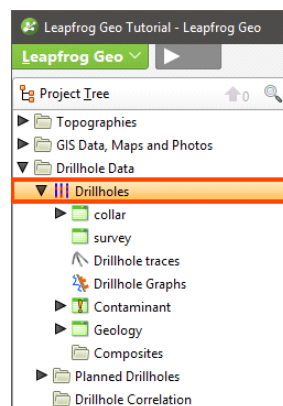

You can open each table by double-clicking on the table (📄). The table will be displayed and you can make changes. See [Working with Data Tables](#). When there are errors in the data, the relevant table will be marked with a red X (❌). See [Correcting Data Errors in Leapfrog Geo](#) for more information on fixing drillhole data errors.

Leapfrog Geo also has tools for creating new lithology data columns from existing columns in order to solve problems with the drillhole data. See [Processing Drillhole Data](#) for more information.

To delete a lithology or numeric data table, right-click on the table in the project tree and select **Delete**. You will be asked to confirm your choice.

When you right-click on the drillhole or collar table object in the project tree and select **Delete**, the resulting action will also remove all lithology and numeric data tables from the project. You will be asked to confirm your choice.

With Leapfrog Geo, you can also plan drillholes and evaluate them against any model in the project. See [Planning Drillholes](#) for more information.

The rest of this topic discusses options for displaying drillholes and viewing statistics on drillhole data tables. It is divided into:

- [Displaying Drillholes](#)
- [Viewing Drillhole Data Table Statistics](#)

Displaying Drillholes

Viewing drillhole data in the scene is an important part of refining drillhole data and building a geological model. Therefore, Leapfrog Geo has a number of different tools for displaying drillhole data that can help in making drillhole data processing and modelling decisions. Display drillhole data in the scene by dragging the **Drillholes** object into the scene. You can also drag individual tables into the scene.

Once drillhole data is visible in the scene, click on a drillhole to view the data being displayed. You can also display the data associated with each interval by clicking on the **Show text** button (A) in the shape list. Here, data display is enabled for two interval tables:

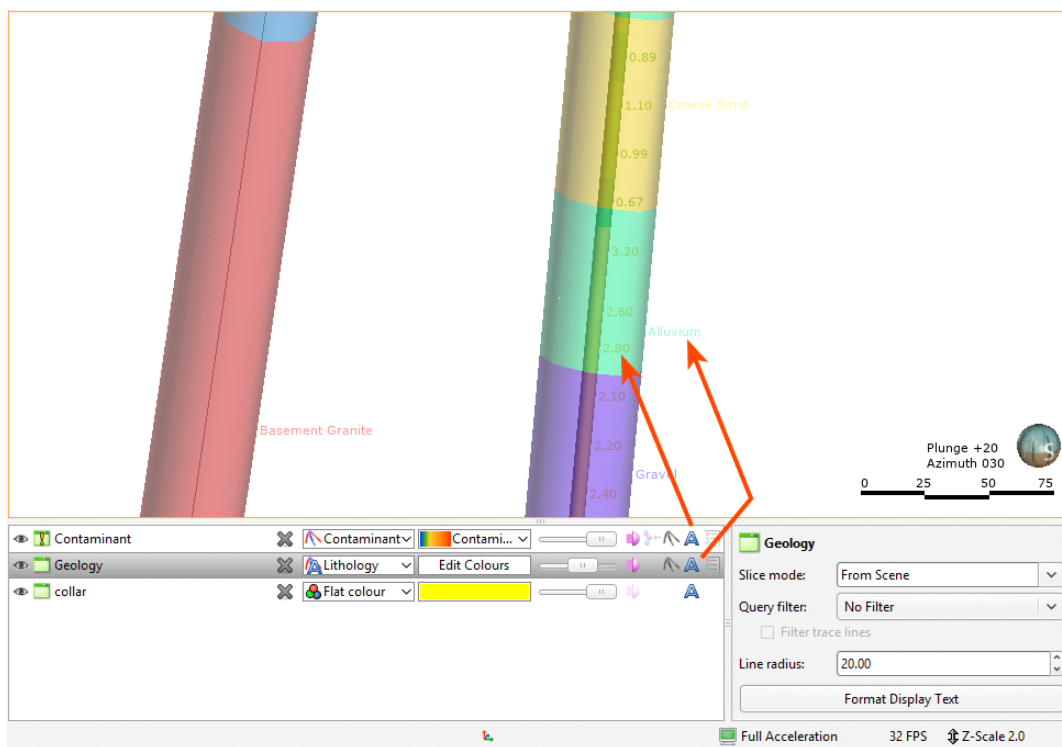

The **Show trace lines** button (A) in the shape list displays all trace lines, even if there is no data defined for some intervals. The **Filter trace lines** option in the shape properties panel displays only trace lines for drillholes selected by a query filter. See the [Query Filters](#) topic for more information.

Displaying Drillholes as Lines or Cylinders

You can display drillholes as lines or cylinders. You can also display the data associated with each segment. Here, the drillholes are displayed as flat lines:

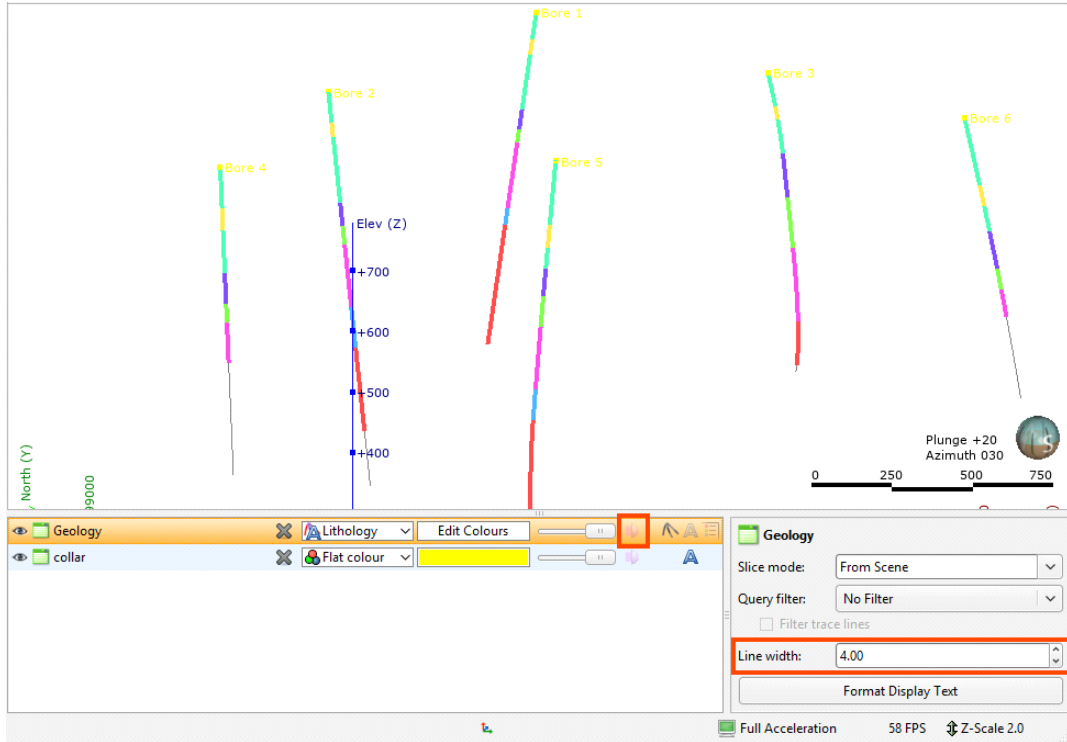

The width of the lines is set in the shape properties panel.

When the **Make lines solid** button (🔴) is enabled, the drillhole data is displayed as cylinders and the property that can be controlled is the **Line radius**:

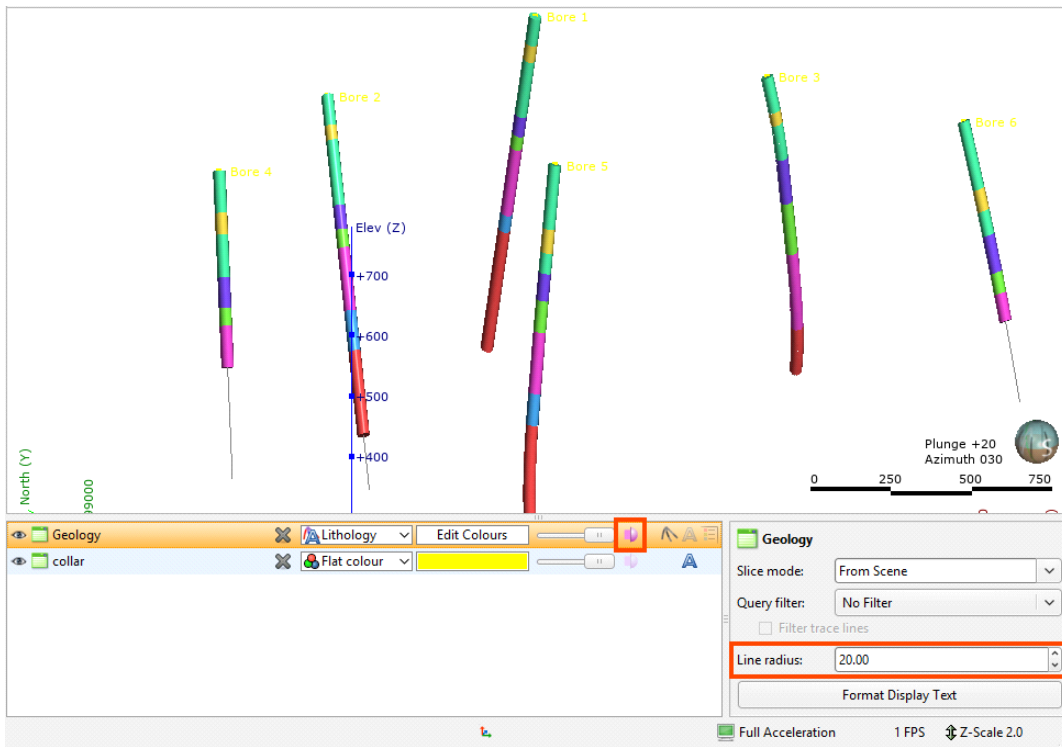

When numeric data is displayed, there is an additional option, to use a data column in the table for the cylinder radius:

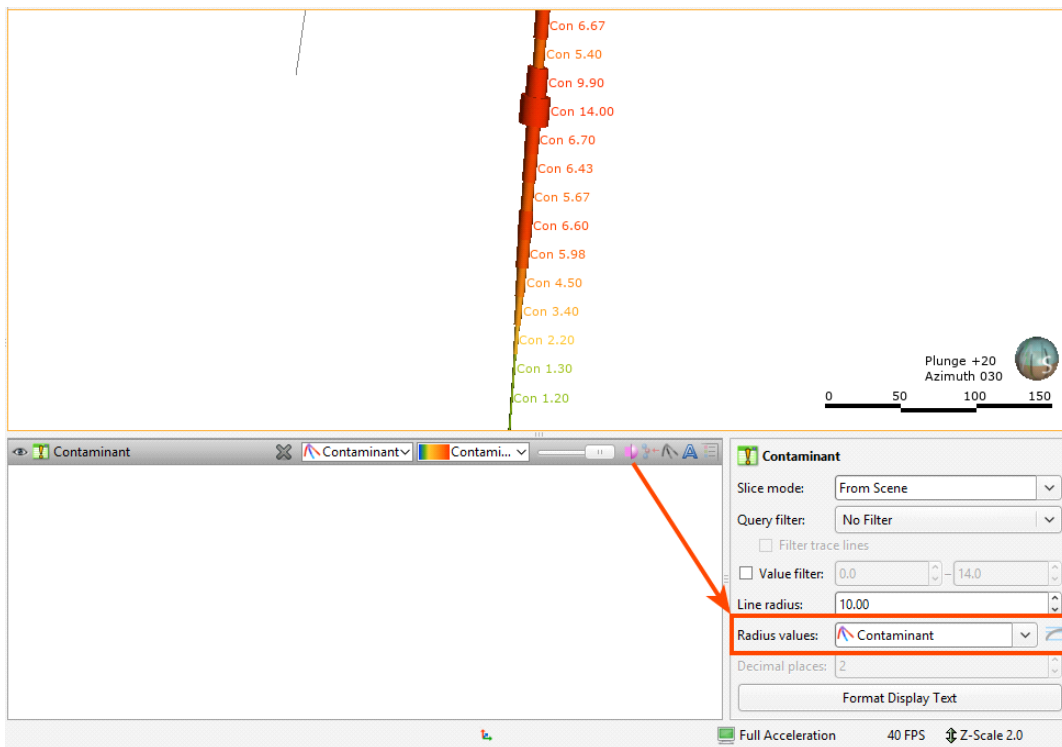

When the log button (📄) is enabled, the log of values is used for the radius.

Hiding Lithologies

When lithology tables are displayed, you can hide some of the lithologies to help make better sense of the information in the scene. Click on the **Edit Colours** button in the shape list. In the window that appears, use the **Show/Hide** buttons (👁️) to determine what segments are displayed:

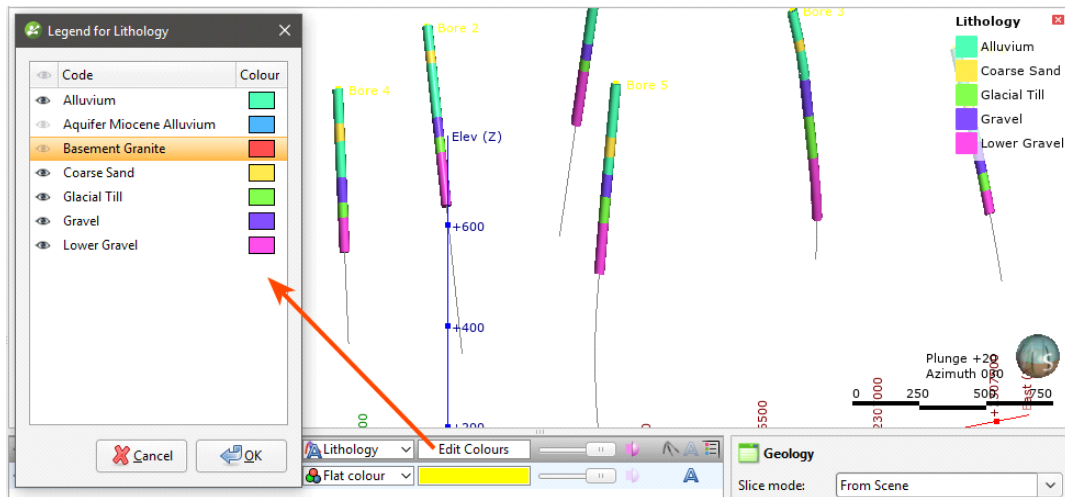

To select multiple lithologies, use the Shift or Ctrl keys while clicking. You can then change the visibility of all selected lithologies by clicking one of the visibility (👁️) buttons.

Hiding lithologies in this way only changes how the data is displayed in the scene. Another way of limiting the data displayed is to use a query filter (see the [Query Filters](#) topic), which can later be used in selecting a subset of data for further processing.

Displaying a Legend

To display a legend in the scene, click the **Show legend** button (📖) for the table:

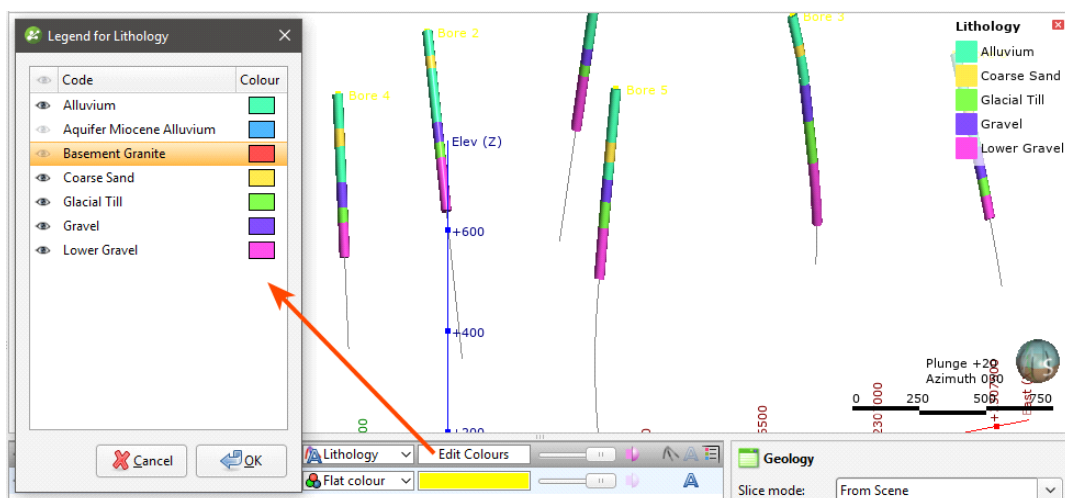

The legend in the scene will be updated to reflect lithologies that are hidden in the scene when you click **Edit Colours** and hide some lithologies.

Changing Colourmaps

To change the colours used to display lithologies, click on the **Edit Colours** button in the shape list. In the window that appears, click on the colour chip for each lithology and change it as described in [Single Colour Display](#).

To set multiple lithologies to a single colour, use the Shift or Ctrl keys to select the colour chips you wish to change, then click on one of the colour chips. The colour changes you make will be made to all selected lithologies.

You can also import a colourmap, which is described in [Colourmaps](#).

Viewing Multiple Interval Tables

When viewing multiple interval tables, use the line and point size controls and the transparency settings to see all the data at once. For example, here, the geology table has been made transparent to show the contaminant intervals inside:

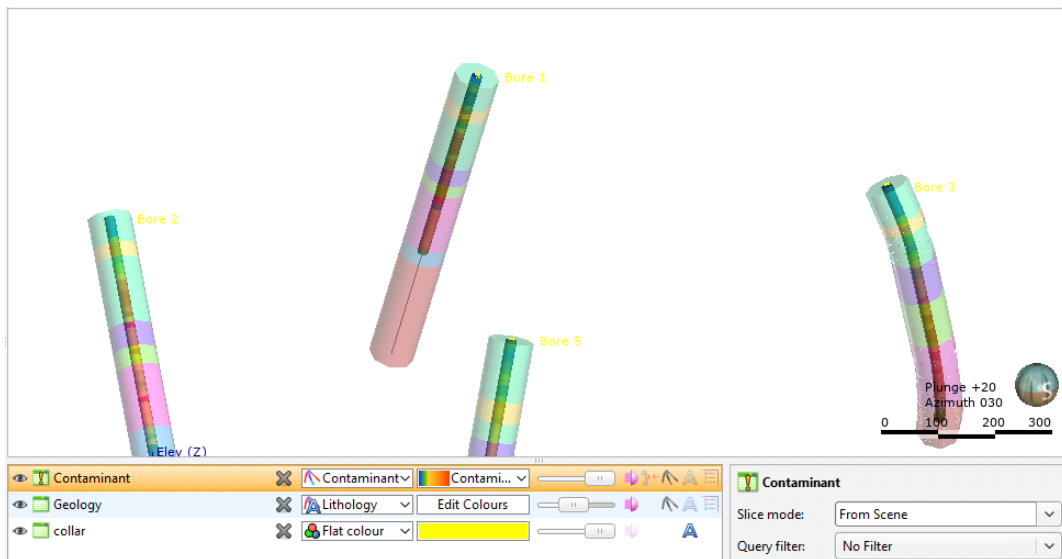

Selecting from Multiple Columns

When an interval table has more than one column of data, select the column to view from the view list:

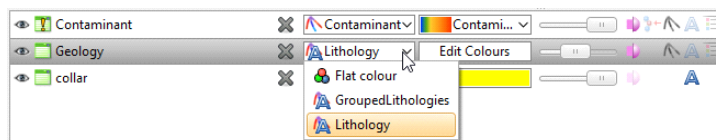

Some columns are editable, in which case you can click on the **Edit** button (✎) to start editing the table:

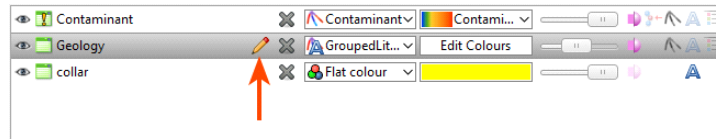

Displaying Interval Data in the Scene

Drillholes can be displayed with the data associated with each segment. For example, in the scene below, contaminant values are displayed along the drillhole:

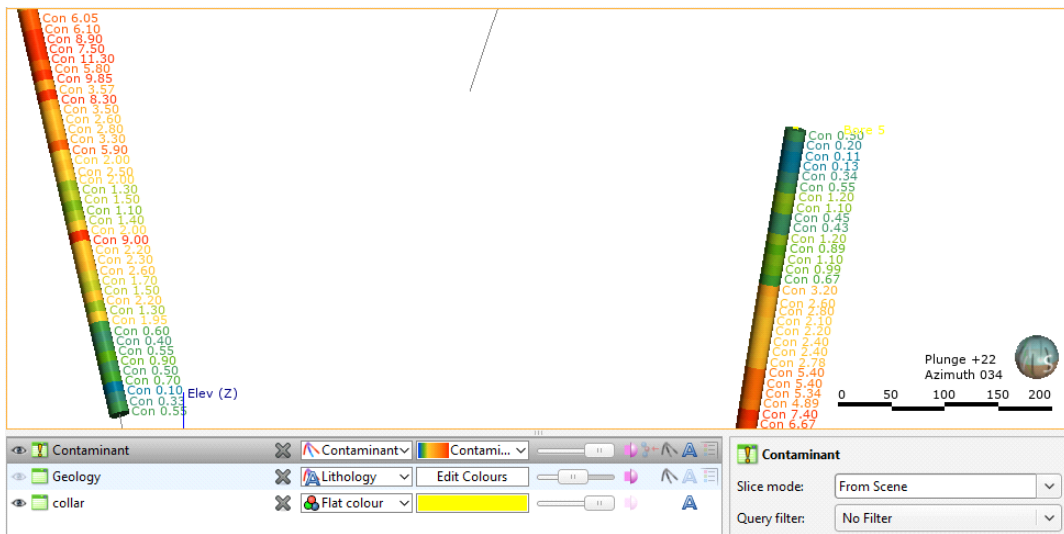

To view data in this way, select the table in the shape list, then click on the **Format Text** button. In the **Text Format** window, click **Insert Column** to choose from the columns available:

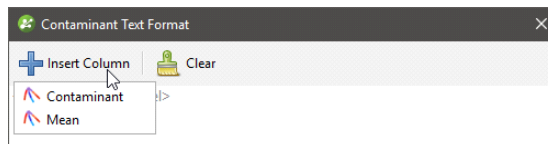

You can display multiple columns and add text:

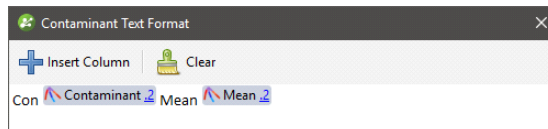

Click **OK** to update the formatting in the scene. You can conceal the formatting in the scene by clicking on the **Show text** button (A) in the shape list:

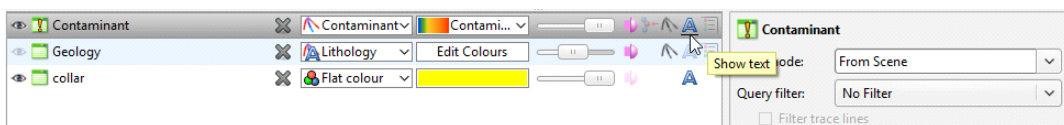

Clear text formatting by clicking on the **Format Text** button, then on **Clear**.

Displaying Drillhole Graphs

Downhole numeric data can be displayed in the scene as a bar graph and downhole points data can be displayed as a line graph. To display downhole data in this way, add the **Drillhole Graphs** object to the scene. The **Drillhole Graph Style Manager** will be displayed, showing the data columns available:

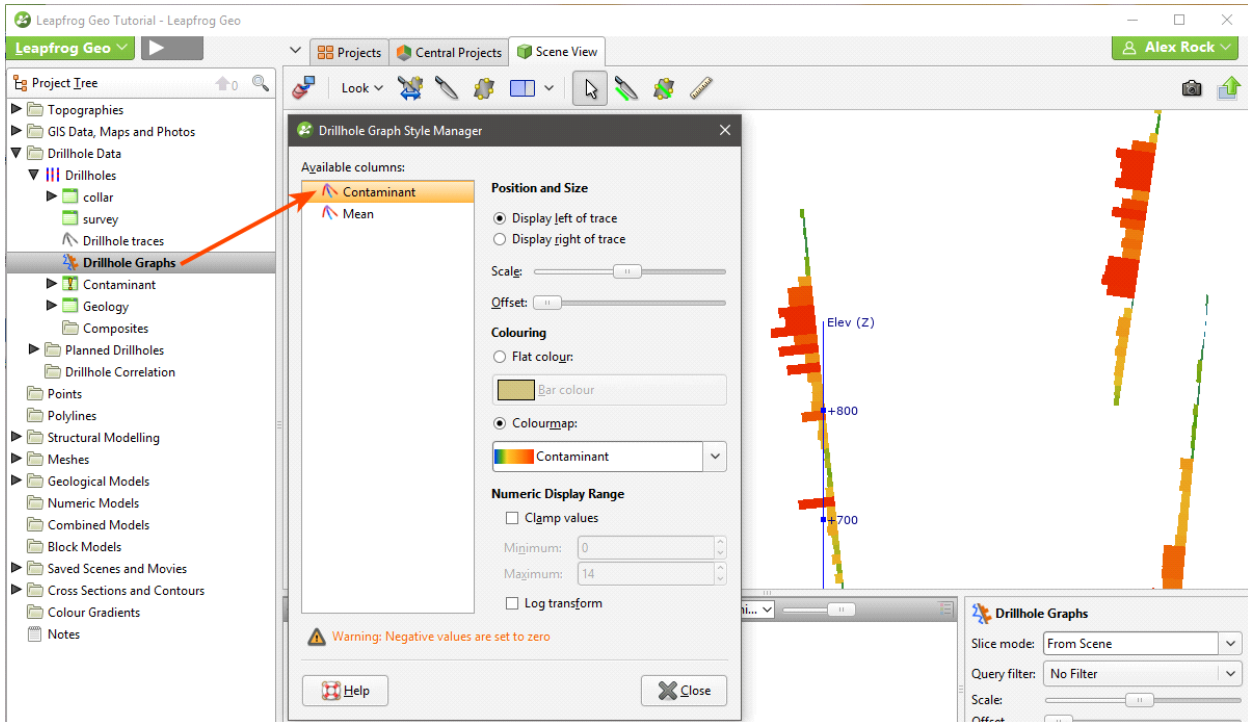

Data can be displayed to the right or the left of the drillhole trace. Use the sliders to change the **Scale** and the **Offset** from the trace.

Data can be clamped, e.g. all values above the set maximum value will be set to the maximum value.

If there are negative values in the data, they will be displayed on the graph with a value of zero.

Downhole points can be displayed as a line, and you can change the **Colouring**, **Scale** and **Offset** of the line:

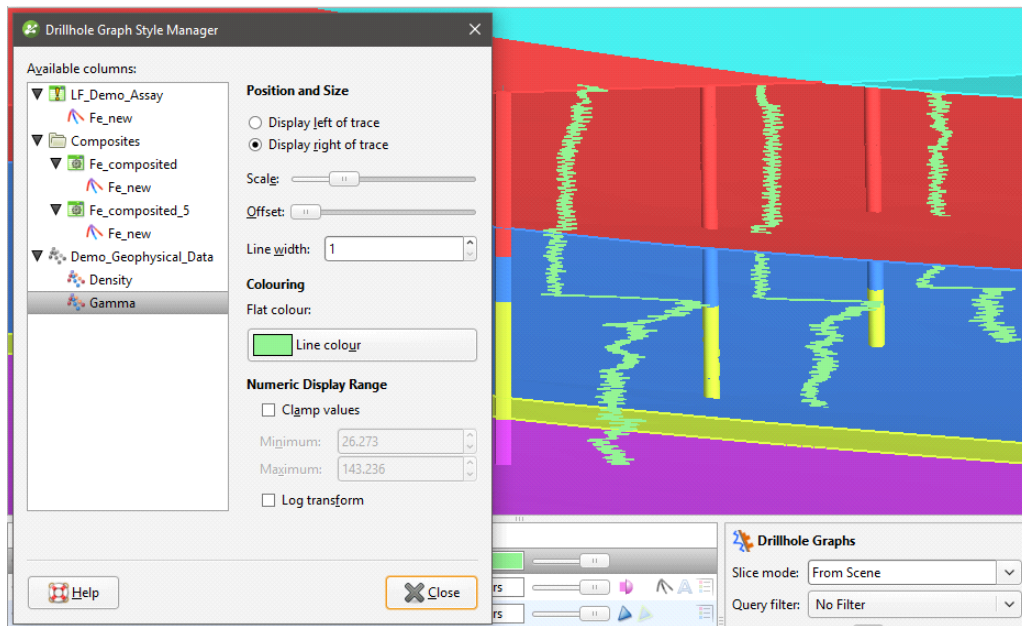

All changes made in the **Drillhole Graph Style Manager** are automatically updated in the scene so you can experiment with the settings. Once you have closed the window, you can also change the **Scale** and **Offset** by clicking on the **Drillhole Graphs** object in the shape list:

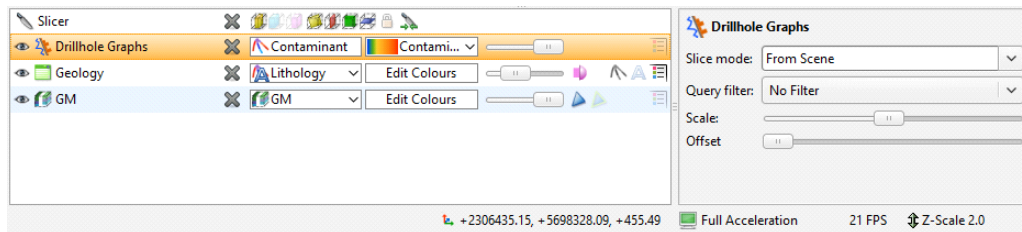

To select a different column to display, open the style manager by double-clicking on the **Drillhole Graphs** object in the project tree or select a new column from the shape list.

If you are working in a new project into which you have just imported drillholes, the **Drillhole Graph Style Manager** will open when you add it to the scene. If the **Drillhole Graph Style Manager** does not open when you add the **Drillhole Graphs** object to the scene, it is because the styles have already been set, perhaps by another user. You can change them by double-clicking on the **Drillhole Graphs** object.

Viewing Drillhole Data Table Statistics

To view statistics on an interval table, right-click on the table in the project tree and select **Statistics**. The following options are available:

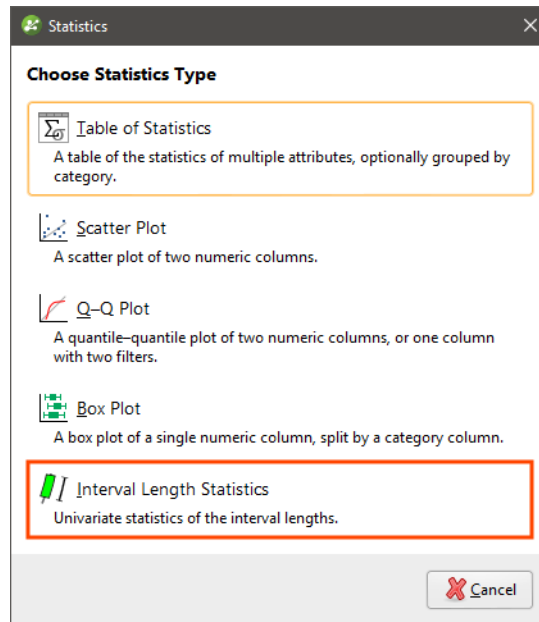

See the [Analysing Data](#) topic for more information on each option:

- [Table of Statistics](#)
- [Scatter Plots](#)
- [Q-Q Plots](#)
- [Box Plots](#)

The **Interval Length Statistics** graph is a univariate graph, so for more information on the options available, see [Univariate Graphs](#) in the [Analysing Data](#) topic.

Right-click on a numeric column and select **Statistics** to open a univariate graph for that column.

Importing Drillhole Data

Drillhole data can be imported from:

- Files stored on your computer or a network location. This process is described below.
- From any database that runs an ODBC interface. See [Selecting the ODBC Data Source](#).
- From an acQuire database. See [Connecting to an acQuire Database](#).

For each of these options, once the data source is selected, the process of importing drillhole data is the same.

The rest of this topic discusses the data format required and the steps for importing drillhole data. It is divided into:

- [Expected Drillhole Data Tables and Columns](#)
- [Selecting Files](#)
- [Working Through the Data](#)

Expected Drillhole Data Tables and Columns

Leapfrog Geo expects drillhole data that is stored in a collar table, a survey table and at least one interval table. A screens table can be imported if you are licensed for the Hydrogeology module.

The following formats are supported:

- CSV Text File (*.csv)
- ASCII Text File (*.asc)
- Plain Text Files (*.txt)
- Data Files (*.dat)
- TSV Text Files (*.tsv)

The Collar Table

The collar table should contain five columns:

- A drillhole identifier
- The location of the drillhole in X, Y and Z coordinates
- The maximum depth of the drillhole

A collar table can also contain a trench column, and collars marked as trenches will be desurveyed in a manner different from other drillholes. See [Drillhole Desurveying Options](#) for more information.

Leapfrog Geo expects a 0 for a normal hole and a 1 for a trench. If there is no trench column in the collar table, Leapfrog Geo will create one.

The drillhole ID is used to associate data in different tables with a single drillhole. The ID for a drillhole must be identical in all tables in order for data to be associated with that drillhole. Inconsistencies in the way drillholes are identified are common sources of errors.

The maximum depth column is optional. If it is present, is used to validate the data imported for the interval tables. The maximum depth specified is often a planned quantity, whereas the interval table records actual measurements. For this reason, Leapfrog Geo has an option for fixing the maximum depth value in the collar table to match the data in an interval table.

If maximum depth information is not included in a collar file, Leapfrog Geo will determine it from the maximum depth sampled as indicated by data in the interval tables.

The Survey Table

For the survey table, Leapfrog Geo expects a minimum of four columns:

- A drillhole identifier
- Depth, dip and azimuth values

By default, Leapfrog Geo assumes that negative dip values point up. If this is not the case, tick the **Negative survey dip points down** option.

See [Drillhole Desurveying Options](#) for more information on the drillhole desurveying algorithms used in Leapfrog Geo.

The Screens Table

A screens table can only be imported if you have the Hydrogeology module.

For the screens table, Leapfrog Geo expects a minimum of four columns:

- A drillhole identifier
- Start/from and end/to depths
- A value column

Interval Tables

For interval tables, Leapfrog Geo expects, at minimum, four columns:

- A drillhole identifier
- Start/from and end/to depths
- A column of measurements

If a drillhole ID in an interval table does not correspond to one in the collar table, the table can still be imported but the interval table will contain errors.

Supported column types are:

- Lithology columns containing lithologic data, which can be used for geological modelling.
- Numeric columns containing numeric values, which can be used for interpolating data.
- Category columns, which is text representing categories such as company, geologist, or mineralisation.
- Text columns containing text data that is not categorical, such as comments. Text columns are not validated when imported.
- Date columns containing date data. Custom date and timestamps formats are supported.
- URL columns. Use the prefix file:/// to link to local files.

When an interval table is displayed in the scene and an interval is selected, clicking on a link in the URL column will open the link. This is a useful way of linking to, for example, data files or core photo images from within Leapfrog Geo:

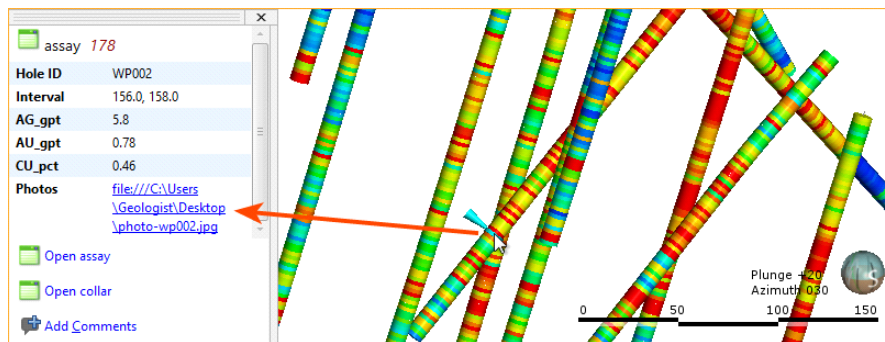

Selecting Files

To import drillhole data, right-click on the **Drillhole Data** folder and select **Import Drillholes**. The **Import Drillhole Data** window will appear:

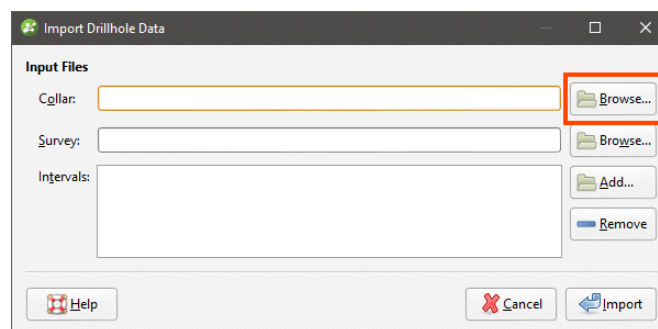

For the **Collar**, click on the **Browse** button to locate the collar file.

When a collar file is added to the **Import Drillhole Data** window, Leapfrog Geo will look for interval tables with names such as "lithology" or "geology" in the same location and will add them to the **Interval Tables** list. If an interval table file is not automatically added to the list, click **Add** and browse for the required file.

If you have the Hydrogeology module, you can also add any screens to import by clicking on the **Screens – Browse** button.

In the screen below, a collar file, a survey file and two interval tables have been selected for import:

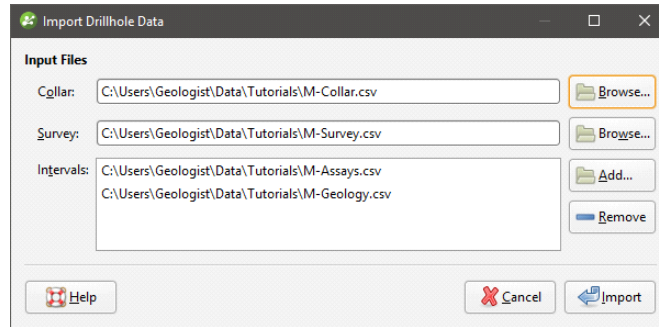

Working Through the Data

Clicking on **Import** starts the process of importing data, which involves matching the data in the selected files with the columns Leapfrog Geo expects for each type of table. Leapfrog Geo will display a series of windows and will attempt to match the data in the files with the columns expected, based on the header rows in each file.

Progress in working through the data is shown at the top of the window:

	Hole ID	East (X)	North (Y)	Elev (Z)	Max Depth	Not Imported/Completed
1	M001	East	North	Elev	Depth	Completed
2	M001	3999.231	7499.063	727.169	250	5/03/1996
3	M002	4050.382	7500.755	726.926	250	9/03/1996
4	M003	4098.904	7500.572	727.68	250	14/03/1996
5	M004	4149.058	7501.102	728.876	275	20/03/1996

The file currently displayed is shown in bold.

For *.csv files that use characters other than the comma as the separator, you can specify the delimiter, comment leader, quote and decimal characters in the **Import Drillhole Data** window. Click on **CSV characters** to enter the characters used in the data files:

The row at the top of the table indicates the data type to which Leapfrog Geo will assign each column:

	Hole ID	East (X)	North (Y)	Elev (Z)	Max Depth
1	HoleID	East	North	Elev	Depth
2	M001	3999.231	7499.063	727.169	250
3	M002	4050.382	7500.755	726.926	250

Click at the top of a column to view the column assignments available. The columns highlighted below are the column types required for the collar table:

	Hole ID	East (X)	North (Y)	Elev (Z)	Max Depth
1	"HoleID_1" Category		North	Elev	Depth
2	"HoleID_1" Text		7499.063	727.169	250
3	"HoleID_1" Numeric		7500.755	726.926	250
4	"HoleID_1" Time Stamp		7500.572	727.68	250
5	"HoleID_1" Date		7501.102	728.876	275
6	"HoleID_1" URL		7499.877	729.739	300
7	Not Imported		7099.258	707.249	480
8	Hole ID		7149.795	703.073	425
9	East (X)		7200.874	706.324	409
10	North (Y)		7250.971	710.789	410
11	Elev (Z)		7099.169	693.874	500
12	Max Depth		7149.709	696.017	500
13	Trench		7200.416	698.098	425
14	Custom Name...		7249.337	699.921	500
15	M014	4499.011	7301.024	701.815	500

Each type of table being imported will have different column assignments available, but all table types will display:

- The categories columns can be assigned to (top of the list)
- The option to not import the column
- The required columns, e.g. drillhole Id, East (X), North (Y) and Elev (Z) for the collar table
- Any optional columns, e.g. Max Depth and Trench
- The option to select a custom name

If the header row for a column cannot be matched, Leapfrog Geo will mark the column as "Not Imported" and you can select from the column assignments available. If you choose not to import a column then wish to do so later, you can add it later using the **Import Column** option. See [Importing Columns](#).

You can also work with the **Column Summary**:

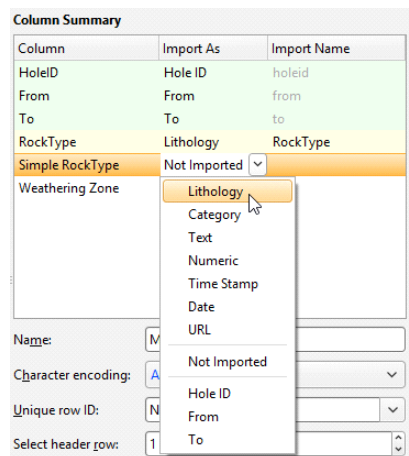

If you wish to import all columns, click on the **Import All Columns** button, then check that all columns have been correctly mapped.

You can select a column for import, then use it as a **Unique Row ID**. This can specify the column being used in other data systems to uniquely identify rows in a table. The column must not contain duplicate values. If a **Unique Row ID** is specified, Leapfrog Geo will use this column to match rows when appending columns or reloading tables.

If the data contains date and time information and the date and time format is not detected, click on **Date and Time Formats** to reveal more information:

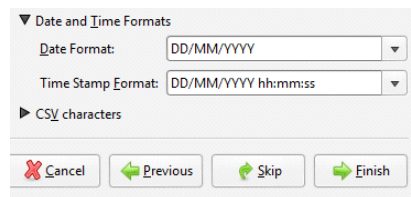

If the date and time format you wish to use is not among the options, you can create a custom format.

For each file, check the column mapping and click **Next** to proceed to the next step. If any of the information Leapfrog Geo expects is missing, an error message will appear. Return to the table and correct the problem described.

Once you have checked the last file, click on **Finish**. Once Leapfrog Geo has imported the data, it will appear in the project tree under a new **Drillholes** object.

Selecting the ODBC Data Source

To import drillhole data directly from any database that uses an ODBC interface, right-click on the **Drillhole Data** folder and select **Import Drillhole Data via ODBC**. The **Select ODBC Data Source** window will appear:

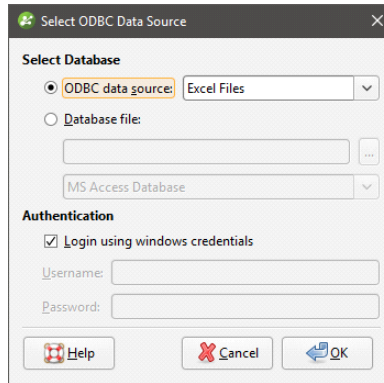

Leapfrog Geo supports database files in Access Database (*.mdb, *.accdb) formats. Enter the information supplied by your database administrator and click **OK**.

Selecting Tables

Leapfrog Geo will select the collar, survey and interval tables from the data in the file, which is displayed in the **Select Tables To Import** window:

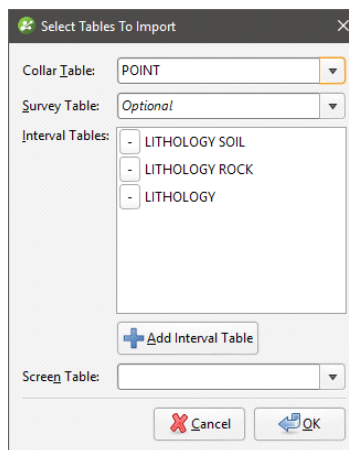

Click on the **Collar Table**, **Survey Table** and **Screen Table** dropdown lists to select from the data available in the file.

To change one of the **Interval Tables** to a different column in the file, click on the table name to highlight it, then click to the right of the column name to activate the dropdown list:

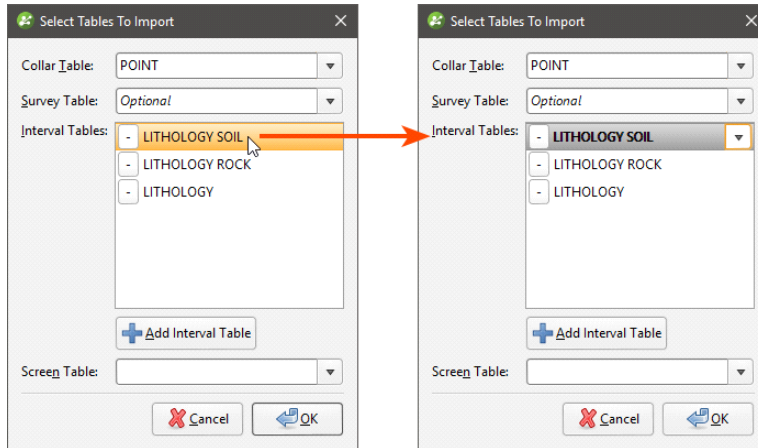

To remove an interval table from the list, click the - button.

To add an interval table, click the **Add Interval Table** button. A - button will be added to the **Interval Tables** list.

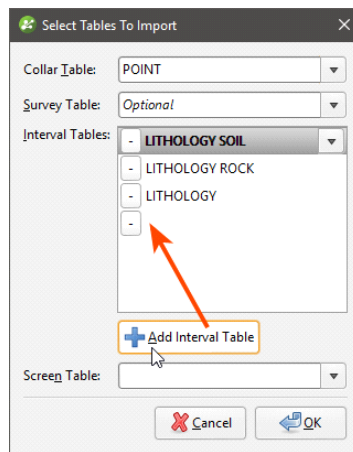

Click on the blank space to highlight it, then click to the right of the column name to activate the dropdown list:

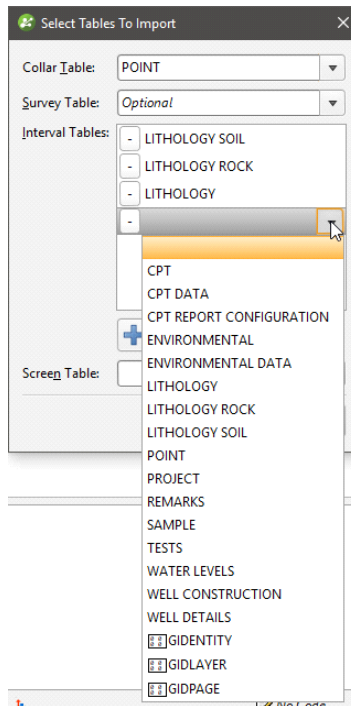

Click **OK** to begin the process of importing the data, which is similar to that described in [Importing Drillhole Data](#).

Connecting to an acquire Database

There are two options for connecting to an acquire database:

- Create a new connection. To do this, right-click on the **Drillhole Data** folder and select **Import Drillhole Data via acquire > New Selection**. Select the server and click **Connect**. Next, enter the login details supplied by your database administrator.
- Create a connection from an existing selection file. Right-click on the **Drillhole Data** folder and select **Import Drillhole Data via acquire > Existing Selection**. Navigate to the location where the selection file is stored and open the file.

Once connected to the database, you will be able to select the required data using the **Select data from acquire** window.

Optionally, click the **Profiles** button and choose a profile from those on the acquire database. Profiles are created in acquire; see your acquire administrator for more information.

You can also use the other tabs on the acquire component interface to make other data selections.

For more information on using the third-party selection tools provided in the **Select data from acquire** window, see your acquire user documentation. When you have finished specifying the selection, click **OK** to import the data. The import process is similar to that described in [Importing Drillhole Data](#).

Once the drillhole data has been loaded, you can:

- Import additional interval tables. See [Importing Interval Tables](#).
- Update the drillhole data with new data from the acQure database. See [Smart Refresh](#).
- Reload drillhole data. See [Reloading Drillhole Data](#).

Smart Refresh

Smart Refresh obtains the latest drillhole data from the acQure database without reloading the entire contents of the database. This reduces the amount of data transfer required and speeds data updated. If any data relating to a drillhole has changed, the whole drillhole is updated. Any new drillholes in the database can be added.

Right-click on the **Drillholes** object in the project tree and select **Smart Refresh**. The **Select data from acQure** window will appear.

If the current data selection settings include data changes, you can click **OK** and the updated data will be imported. You may also chose to modify the data selection settings, which may append further data when you click **OK**.

Saving a Selection

Saving a selection saves the current acQure database selection to file for future reuse. You can use a selection to import the same set of drillhole data in new Leapfrog Geo projects.

To save an acQure selection, right-click on the **Drillholes** object in the project tree and select **Save Selection**. You will be prompted for a filename and location.

Appending Drillholes

If drillhole data is stored in multiple files or new drillhole data is available, you can import other files into the project and add them to the existing drillhole data. To do this, right-click on the **Drillholes** object and select **Append Drillholes**.

Append drillhole data when you have new drillholes or wish to add extra length to existing drillholes. If you wish to refresh drillhole data, overwriting all existing drillhole data, use the **Reload Drillholes** option.

The **Append Drillholes** window will be displayed. Appending drillhole data is similar to importing the original data (see [Importing Drillhole Data](#)):

- If the drillhole data was loaded from a file on your computer or a network location, you will be asked to specify the file locations. Step through the files, checking the **Column Summary** for each file to ensure that the correct information will be imported, then click **Finish** to add the new files.
- If the interval table is stored in an ODBC database, you will be prompted to connect to the database. See [Selecting the ODBC Data Source](#).

- If your drillhole data is stored in an acQuire database, you will be prompted to connect to the database. See [Connecting to an acQuire Database](#).

Importing Interval Tables

Interval tables that have not been imported during the drillhole data import process can be added to the project at any time. To add an interval table, right-click on the **Drillholes** object in the project tree and select from the options available:

- If the interval table is stored in a file on your computer or a network location, select **Import From File > Interval Values**. Leapfrog Geo will ask you to specify the file location, and then will display the data in the file in the **Import Interval** window.
- If the interval table is stored in an ODBC database, select **Import From ODBC > Interval Values**. You will be prompted to select the data source. See [Selecting the ODBC Data Source](#).
- If your drillhole data is stored in an acQuire database, select **Import From acQuire > Interval Values**. See [Connecting to an acQuire Database](#).

Columns required are:

- A drillhole identifier
- Start/from and end/to depths
- A column of measurements

See [Expected Drillhole Data Tables and Columns](#) for more information on the supported column types.

Select the required columns and assign the data type for each column. Click **Finish** to import the file, which will appear under the **Drillholes** object.

Importing Columns

Columns of an interval table that have not been imported during the drillhole data import or that are stored in a separate file can be added to the table at any time. To do this, right-click on the interval table in the project tree and select **New Column > Import Column**.

Importing a column is similar to importing interval tables themselves. Leapfrog Geo will ask you to specify the file location, and then will display the data in the file in the **Add Column To Table** window. Select as many columns to import as required and assign the appropriate data type. Before finishing, check the **Column Summary** to ensure that the correct information will be imported.

It is not necessary to re-import any columns that are already part of the project. The drillhole ID and To and From data columns, however, will be used to check the validity of the new column against existing data. Any rows that do not match will not be imported.

Click **Finish** to import the new column.

Importing Screens

This feature is only available as part of the Hydrogeology module. See [Flow Models](#) for more information.

Screens that have not been imported during the drillhole data import process can be added to the project at any time. To do this, right-click on the **Drillholes** object in the project tree and select **Import From File > Screens** or **Import From ODBC > Screens**.

When importing from a file, Leapfrog Geo will ask you to specify the file location, and then will display the data in the file in the **Import Screen** window.

When importing from ODBC, you will first be prompted to select the data source. See [Selecting the ODBC Data Source](#).

Columns required are:

- A drillhole identifier
- Start/from and end/to depths
- A value column

Select the required columns and assign the data type for each column. Click **Finish** to import the file, which will appear under the **Drillholes** object.

A Leapfrog Geo project can have only one screens table.

Importing Point Values Down Drillholes

To import a set of points on drillholes, right-click on the **Drillholes** object in the project tree and select **Import From File > Point Values** or **Import From ODBC > Point Values**.

When importing from a file, Leapfrog Geo will ask you to specify the file location and then will display the data in the file in the **Import Depth Points** window.

When importing from ODBC, you will first be prompted to select the data source. See [Selecting the ODBC Data Source](#).

Columns required are:

- A drillhole identifier
- Depth

Select the required columns and assign the data type for each column. Click **Finish** to import the file, which will appear under the **Drillholes** object.

Importing LAS Points Down Drillholes

Leapfrog Geo imports LAS points down drillholes in LAS 1.2 and LAS 2.0 formats. An imported set of LAS files appears as one object with its associated data columns plus a **LAS Drillholes** folder that contains a filter for each drillhole. Importing the data preserves the metadata from the LAS files, which can be viewed in the **Properties** window for the LAS points object and in the **Properties** window for each drillhole.

To import LAS points down drillholes, right-click on the **Drillholes** object and select **Import From File > LAS Data**. Select the files you wish to import and click **Open**.

Next, the **Import LAS Data** window will appear. The data displayed in this window is combined from the selected files, with blank and invalid values indicated by "nan". For example, if a drillhole file does not contain columns that are included in other drillhole files, those missing columns will be marked as "nan".

Leapfrog Geo expects drillhole ID and Depth columns and will attempt to match the data in the files with the expected format. Select the columns to import, then click **Finish**. The files will be added to the project tree as part of the **Drillholes** object, as described above.

To view LAS points, add the LAS points object (📁) to the scene. You can also display individual drillholes by adding their filters to the scene.

LAS File Mapping

The **Properties** window for **LAS Drillholes** includes a **LAS Mapping** tab that shows what data files have been used for the selected drillhole:

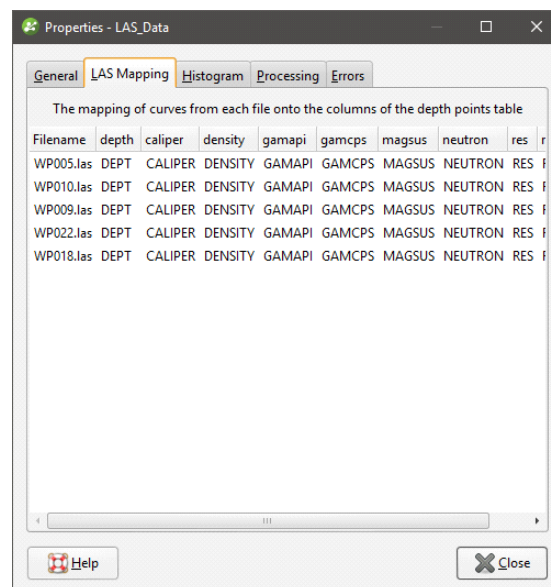

This is useful when data for a drillhole originates in different files.

LAS File Inconsistencies

When importing LAS files, inconsistencies in the files are handled as follows:

- If there are two files with the same curve values at the same depth, the duplicate values will be added to the existing column and flagged as overlapping segments. See [Correcting Data Errors in Leapfrog Geo](#) for more information about correcting drillhole data errors.
- If there are more than two files with the same curve values at the same depth, Leapfrog Geo will not be able to import the files. Note the conflicting files shown in the error message and reimport the files, leaving the conflicting files out.
- If there are multiple logs of the same name in the files, Leapfrog Geo will not be able to import the data. Edit the LAS file header outside of Leapfrog Geo to change the names.

Importing Downhole Structural Data

Leapfrog Geo supports structural measurements in .csv or text formats. This topic describes importing downhole structural data tables. Structural data tables that include location information can also be imported to the **Structural Modelling** folder. See [Importing Planar Structural Data](#).

To import a set of structural data on drillholes, right-click on the **Drillholes** object in the project tree and select **Import From File > Planar Structural Data** or **Import From ODBC > Planar Structural Data**.

When importing from a file, Leapfrog Geo will ask you to specify the file location and then will display the data in the file in the **Import Planar Structural Data** window.

When importing from ODBC, you will first be prompted to select the data source. See [Selecting the ODBC Data Source](#).

Leapfrog Geo expects columns describing the drillhole identifier, the depth and the structural orientation. Structural orientation can be specified using either dip and dip azimuth or alpha and beta.

Match the values in the file to the required column headers, then click **Finish** to import the file. The table will appear under the **Drillholes** object.

If the structural orientation is specified using alpha and beta, the reference line from which the beta is measured can be the bottom or top of the drillhole. When the table is imported, the default setting is **Bottom of core**. To change this, double-click on the structural data table in the project tree. Next, click on **Compatibility** to change the **Beta reference mark** setting to **Top of core**:

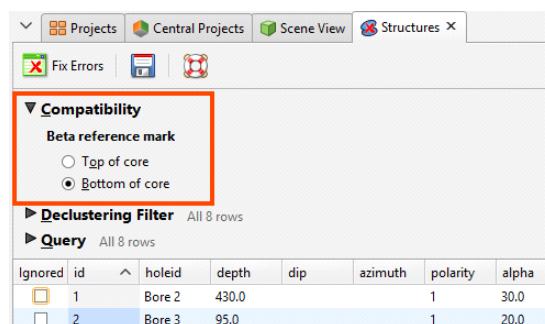

Drillhole Desurveying Options

Drillhole desurveying computes the geometry of a drillhole in three-dimensional space based on the data contained in the survey table. Under ideal conditions, the drillhole path follows the original dip and azimuth established at the top of the drillhole. Usually, though, the path deflects away from the original direction as a result of layering in the rock, variation in the hardness of the layers and the angle of the drill bit relative to those layers. The drill bit will be able to penetrate softer layers more easily than harder layers, resulting in a preferential direction of drill bit deviation.

There are a number of paths a drillhole could take through available survey measurements, but the physical constraints imposed by drilling are more likely to produce smoother paths.

Selecting the desurveying method that gives the best likely approximation of the actual path of the drillhole will ensure that subsequent modelling is as accurate as possible.

Leapfrog Geo implements three algorithms for desurveying drillholes:

- [The Spherical Arc Approximation Algorithm](#)
- [The Raw Tangent Algorithm](#)
- [The Balanced Tangent Algorithm](#)

These options are described in more detail below.

Another factor that affects how drillholes are desurveyed is how dip values are handled. When the survey table is imported, Leapfrog Geo sets the **Negative survey dip points down** value according to the data in the imported table. When the majority of the dip data in the table is positive, Leapfrog Geo assumes all these drillholes will point down and leaves the field **Negative survey dip points down** disabled. When most of the values are negative, the field is enabled. This field can be changed by double-clicking on the survey table to open it and then clicking on **Compatibility** to show the table's desurveying settings:

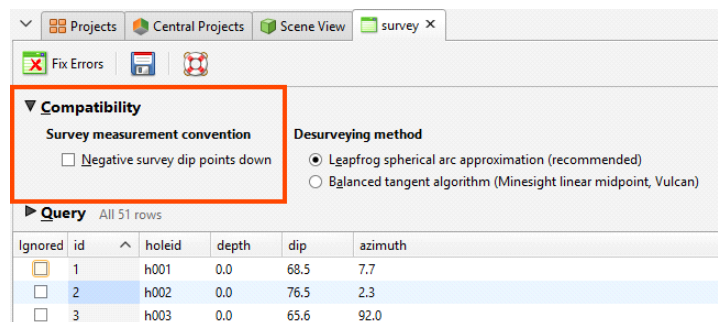

If you are going to change the automatically set value of **Negative survey dip points down**, consider carefully the implications if there is a mix of drillholes pointing down and up.

The other **Compatibility** setting relates to the algorithm used in desurveying the drillholes.

The Spherical Arc Approximation Algorithm

The default algorithm used in Leapfrog Geo is spherical arc approximation, which is sometimes referred to as the minimum curvature algorithm. Downhole distances are desurveyed exactly as distances along a circular arc:

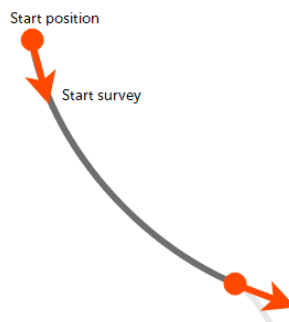

The algorithm matches the survey at the starting and end positions exactly and the curvature is constant between these two measurements. At the survey points, the direction remains continuous and, therefore, there are no unrealistic sharp changes in direction.

If you wish to use spherical arc approximation, there is no need to change any settings.

The Balanced Tangent Algorithm

The balanced tangent algorithm uses straight lines but attempts to improve the accuracy of the raw tangent algorithm by assigning equal weights to the starting and end survey measurements:

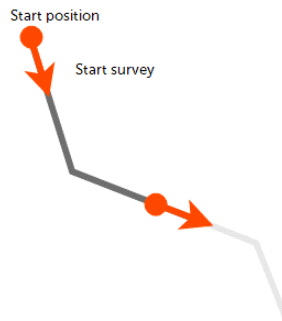

It is an improvement on the raw tangent algorithm but still suffers from an unrealistic discontinuity in the drillhole path. It is, however, a better approximation of the overall drillhole path and is reasonably accurate when the spacing between measurements is small.

To use the balanced tangent algorithm, double-click on the survey table in the project tree. Click on **Compatibility** and change the **Desurveying method**.

The Raw Tangent Algorithm

The raw tangent algorithm assumes the drillhole maintains the direction given by the last survey measurement until the next new measurement is reached:

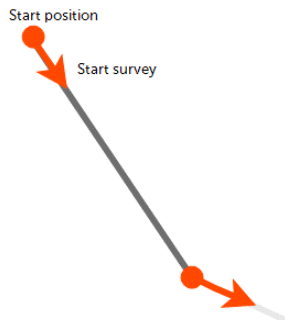

This implies that the drillhole makes sharp jumps in direction whenever a measurement is taken, which is unlikely, except when the drillhole is being used to define a trench.

Collar tables have a **trench** column that indicates whether or not the drillhole is from a trench. When the **trench** column is ticked for a drillhole, the trench will be desurveyed using the raw tangent algorithm. Double-click on the collar table in the project tree, then tick the **trench** box for the drillholes you wish to desurvey using the raw tangent algorithm.

Processing Drillhole Data

Once imported and corrected, drillhole data usually requires further processing before any models are built. Use the techniques described in [Displaying Drillholes](#) and [Drillhole Correlation Tool](#) to aid in making decisions on what further processing is required.

Often, selecting a small portion of intervals can be achieved using a query filter (see the [Query Filters](#) topic). In some cases, however, you may wish to composite data to focus on a single unit. There may also be issues with how drillhole data has been recorded; for example, two units have been catalogued as one, or a single unit may be divided into multiple units.

Leapfrog Geo has a number of tools for processing drillhole data, including:

- **Category Composites.** Sometimes unit boundaries are poorly defined, with fragments of other lithologies within the lithology of interest. This can result in very small segments near the edges of the lithology of interest. Modelling the fine detail is not always necessary, and so compositing can be used to smooth these boundaries.
- **Economic Composites.** Economic compositing classifies assay data into “ore” and “waste” categories, taking into account grade thresholds, mining dimensions and allowable internal dilution. The result is an interval table with a column of ore/waste category data and a column of composited interval values, plus some additional columns showing the length, linear grade, included dilution length and included dilution grade.
- **Majority Composites.** Category data can be composited into interval lengths from another table or into fixed interval lengths. The compositing is based on a majority percentage where each interval is assigned a category based on the category that makes up the highest percentage of the new interval.
- **Numeric Composites.** Compositing numeric data takes unevenly-spaced drillhole data and turns it into regularly-spaced data, which is then interpolated. Numeric data can be composited along the entire drillhole or in selected regions. You can also set the compositing length from the base interval table.
- **Grouping Lithologies.** The group lithologies tool lets you define a new unit to which existing units are added. For example, a sandstone deposit might appear in an interval table as poorly-sorted and well-sorted units. The group lithologies tool lets you group both units into a single sandstone unit.
- **Splitting Lithologies.** Lithology units may be incorrectly grouped, which can become apparent when you display drillholes in the scene. The split lithologies tool lets you create new units by selecting from intervals displayed in the scene.
- **Interval Selection.** If the lithologies in a column are poorly sorted, you can display the column in the scene and use the interval selection tool to work with all the segments and sort them into new units.
- **Overlaid Lithology Column.** You may have two versions of an interval column, one that contains draft data and one that contains the final version. The final version may contain gaps, which can be filled in using the draft version. The overlaid lithology tool lets you combine the two columns to create a new column.

- [Category Column from Numeric Data](#). When you have numeric data you wish to use with the lithology and category modelling tools, you can convert the numeric data to a category column.
- [Back-Flagging Drillhole Data](#). Evaluating geological models on drillholes creates a new lithology table containing the lithologies from the selected model.

Each of these tools creates a new interval table or creates a new column in an existing interval table, preserving the original data. New tables and columns can be used as the basis for new models in the project and can be incorporated into existing models using **From Other Contacts** options. When a new table is created, you can view it in the scene along with the original table to see the differences between the processed and the unprocessed data.

If you are working with columns in different interval tables, you can create a new merged table that includes columns from these different tables. Columns created in Leapfrog Geo can be included in a merged table. See [Merged Drillhole Data Tables](#).

Category Composites

Sometimes unit boundaries are poorly defined, with fragments of other lithologies within the lithology of interest. This can result in very small segments near the edges of the lithology of interest. Modelling the fine detail is not always necessary, and so compositing can be used to smooth these boundaries.

In Leapfrog Geo, you can composite category data in two ways:

- Composite the drillhole data directly. This creates a new interval table that can be used to build models, and changes made to the table will be reflected in all models based on that table. This process is described below.
- Composite the points used to create an object.

The rest of this topic describes compositing drillhole data directly.

Right-click on the **Composites** folder, which is in the project tree as part of the **Drillholes** object, and select **New Category Composite**. You will be prompted to select from the category columns available in the drillhole data. Next, the **New Compositing Table** window will appear, showing the options for sorting intervals in the selected column:

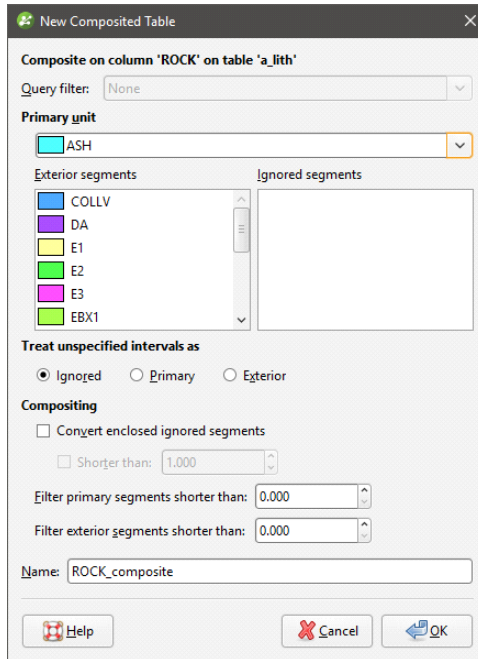

Compositing category data sorts segments into three categories:

- **Primary**. This is the unit of interest. In the case of compositing on intrusion contact surfaces, this will be the interior/intrusive lithology.
- **Ignored**. These are units that are, generally, younger than the unit of interest and should, therefore, be ignored in generating contact surfaces.
- **Exterior**. These are units that occur outside of the unit of interest. For an intrusive lithology, other lithologies the intrusion contacts should be classified as **Exterior**.

Unspecified intervals can be handled as **Ignored**, **Primary** or **Exterior**.

The additional compositing parameters determine how ignored segments flanked by interior or exterior segments are handled and the length of segments that will be filtered. Each of these settings is discussed below.

Click **OK** to create the table. Once you have created a composited table, you can edit it by right-clicking on it and selecting **Edit Compositing Table**.

Converting Ignored Segments

The **Convert enclosed ignored segments** setting determines how ignored segments are handled when they are flanked by either two interior segments or two exterior segments. If **Convert enclosed ignored segments** is enabled, Leapfrog Geo will convert enclosed ignored segments to match the surrounding segments. In cases where an ignored segment does not lie between two interior or exterior segments, it will remain ignored.

If you wish to set a maximum size for ignored enclosed segments, tick the **Shorter than** box and set the maximum length.

If **Convert enclosed ignored segments** is disabled, this processing does not occur and ignored segments are never converted. When an intrusive contact surface is created, this setting is disabled by default.

For example, this scene shows two ignored segments that are flanked by the unit of interest. Because **Convert enclosed ignored segments** is disabled, the segments remain ignored:

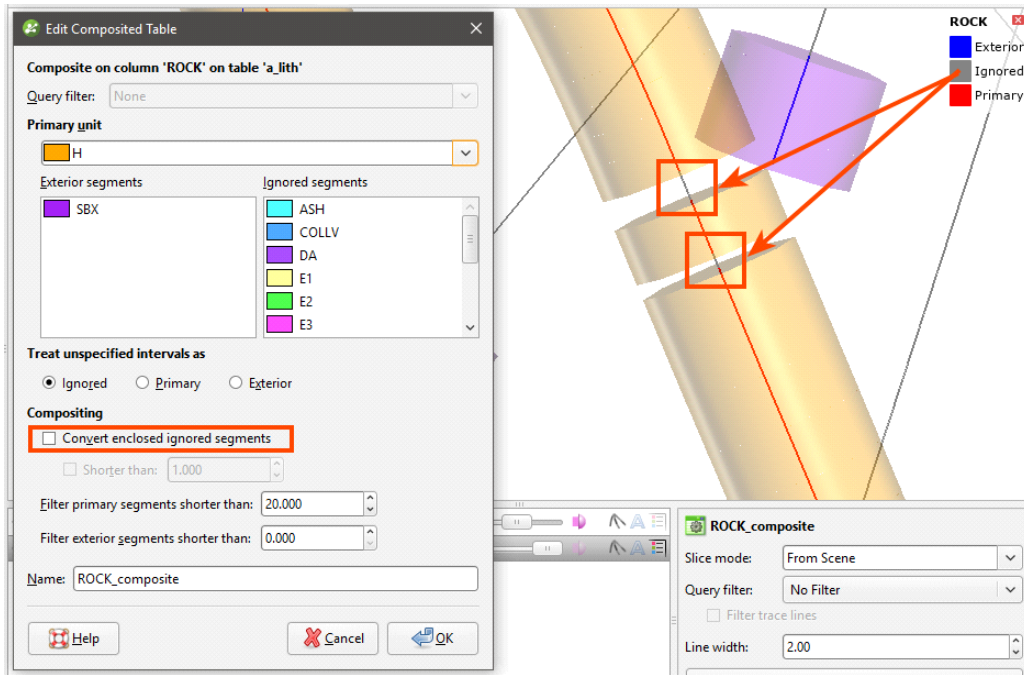

Enabling **Convert enclosed ignored segments** results in the segments being converted to the **Primary** unit:

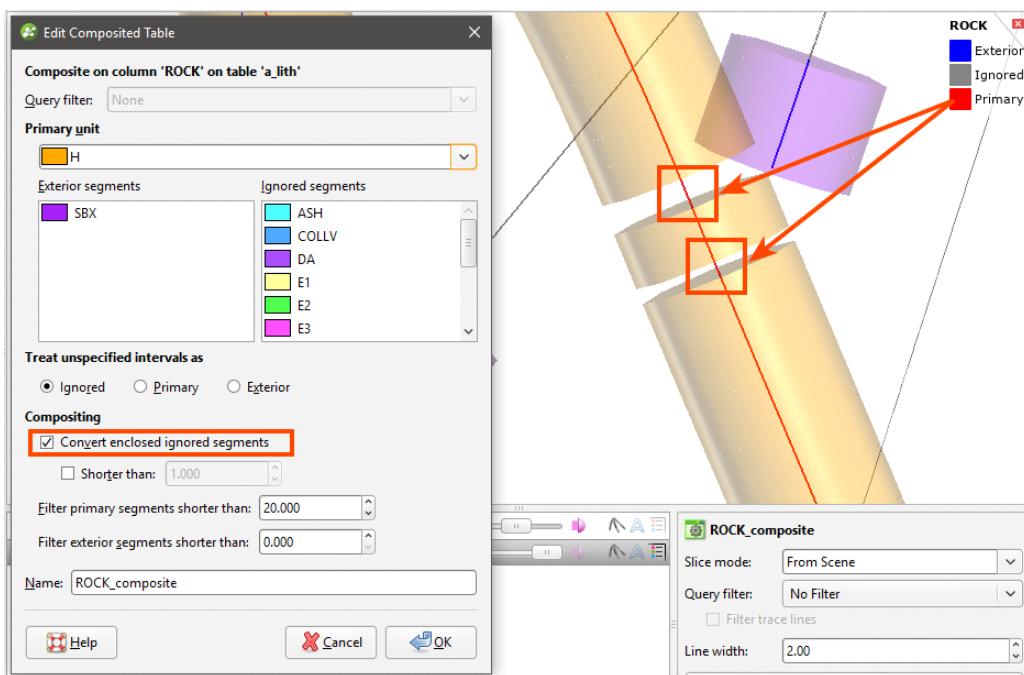

Enabling **Shorter than** and setting it to 4 results in the shorter segment being converted to the **Primary** unit and the longer segment remaining **Ignored**:

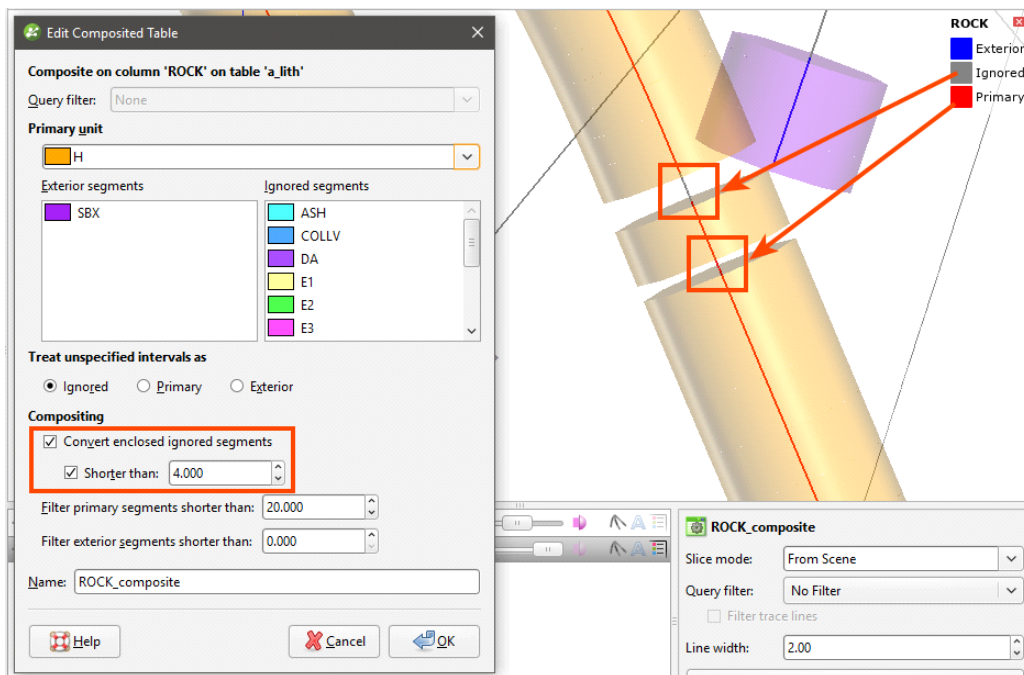

Zooming out, we can see that the ignored segments at the top of the drillholes have not been converted:

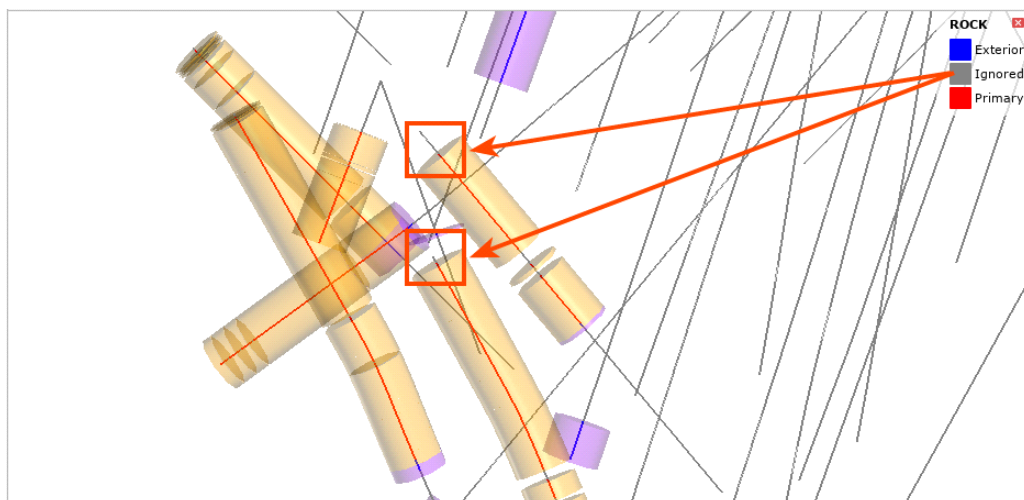

Filtering Short Segments

The **Filter primary segments** and **Filter exterior segments** parameters determine how short a segment must be before it is composited:

- Short **Exterior** segments flanked by **Primary** segments will be converted to **Primary** segments.
- Short **Primary** segments flanked by **Exterior** segments will be converted to **Exterior** segments.

When the value is set the zero, no segments will be converted.

To see how these parameters can smooth the shape of a unit of interest, let's look at a series of drillholes where we wish to create an intrusion boundary based on the red segments. Short segments are highlighted in the intervals that have not been composited:

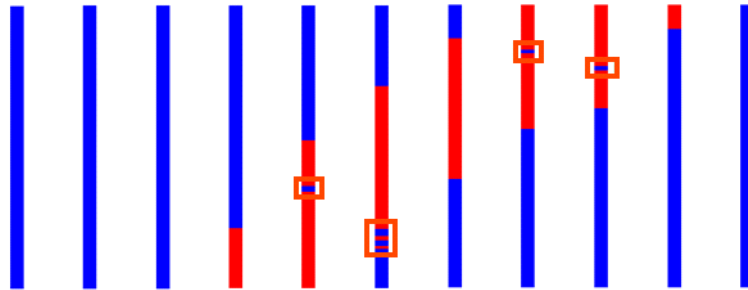

An intrusion generated from these intervals will have more detail than is necessary for modelling. However, when compositing settings are applied and the short intervals are converted, we can see that the intrusion boundary is more geologically reasonable:

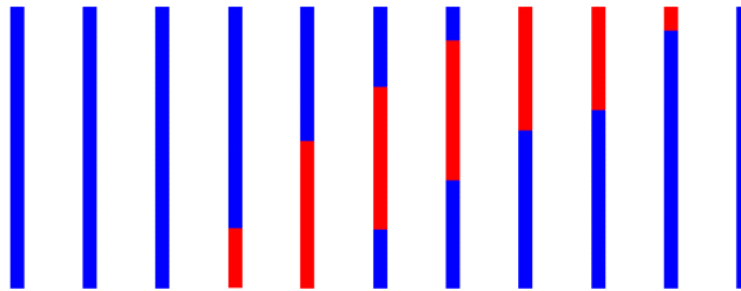

Viewing Category Composite Statistics

Once you have created a composited table, you can view statistics on the table. To do this, right-click on it and select **Statistics**. The following options are available:

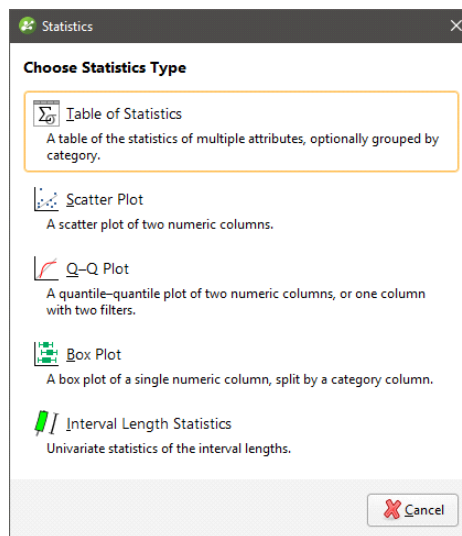

See the [Analysing Data](#) topic for more information on each option:

- [Table of Statistics](#)
- [Scatter Plots](#)
- [Q-Q Plots](#)
- [Box Plots](#)

The **Interval Length Statistics** graph is a univariate graph, so for more information on the options available, see [Univariate Graphs](#) in the [Analysing Data](#) topic.

Economic Composites

Economic compositing classifies assay data into “ore” and “waste” categories, taking into account grade thresholds, mining dimensions and allowable internal dilution. The result is an interval table with a column of ore/waste category data and a column of composited interval values, plus some additional columns showing the length, linear grade, included dilution length, included dilution grade and the percentage of the composite that is based on missing (and then filled) interval data.

Economic compositing is primarily an input into the modelling of geometry rather than the modelling of grade. Whereas numeric compositing transforms variable length assay intervals into consistent intervals with a common support length, economic composite intervals can be of any length, with the composited lengths always coinciding with the end of an assay interval. One common use for economic compositing is to generate a reasonable mineralised envelope from “ore” intervals, which has the benefit of being built on both mineability parameters and cut-off grade.

Economic compositing is based on a set cut-off grade, such that values that are greater than or equal to the cut-off value are considered “Ore” and values below are considered “Waste”. Adjacent intervals on the same side of the cut-off grade are concatenated, producing a series of alternating ore and waste segments. The alternating waste and ore segments are then composited, with the segments being considered for incremental addition to an ore composite sequentially down each drillhole. Although the compositing process produces both ore and waste composites, it only attempts to build ore composites. Waste composites are produced when a composite fails to meet the constraints required for an ore composite, or as initial or final segments.

The rest of this topic describes creating and working with economic composites. It is divided into:

- [Creating an Economic Composite](#)
- [Selecting Values](#)
- [Handling Missing Intervals and High Grades](#)
- [Selecting a Dilution Rule](#)
- [Setting the Cut-Off Grade](#)
- [Two-Pass Compositing](#)
- [Using True Thickness](#)

- [The Compositing Process and Parameters](#)
- [Viewing Compositing Results](#)

Creating an Economic Composite

To create an economic composite, right-click on **Drillholes > Composites** folder and select **New Economic Composite**. The **New Economic Composite** window will appear:

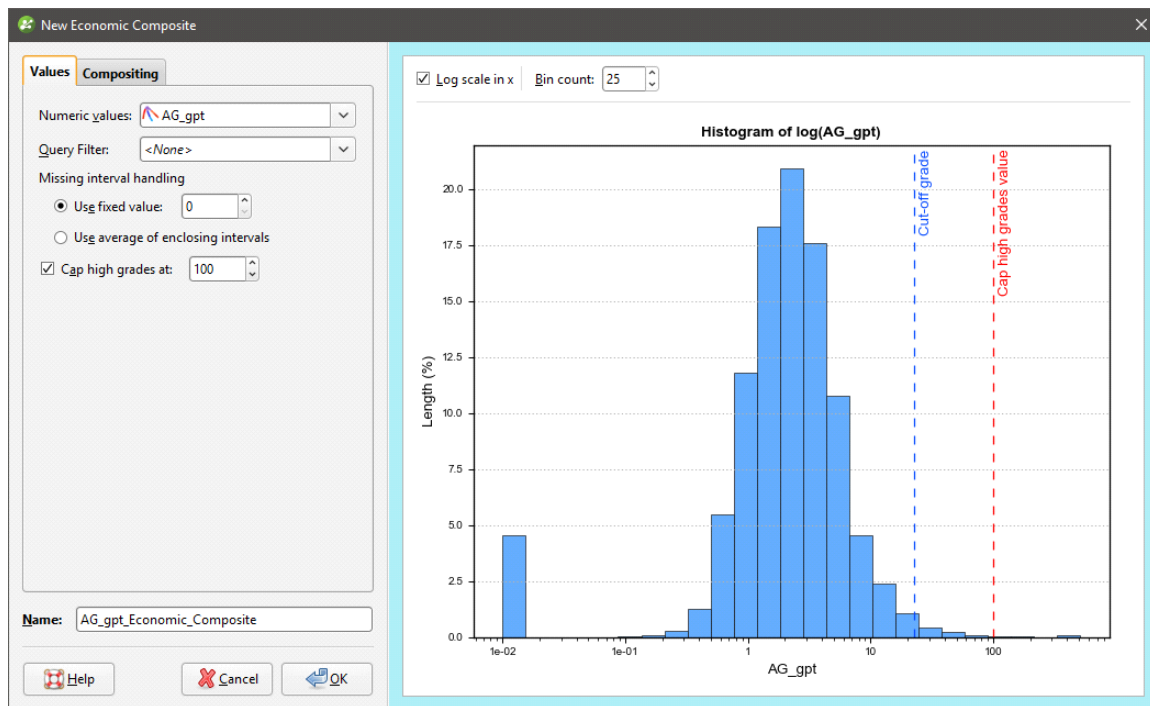

This window has three parts: a **Values** tab, a **Compositing** tab and a histogram of the raw uncomposited data. When adjusting the histogram:

- **Log scale in x** changes the x-axis scale between a linear and log scale
- **Bin count** adjusts the number of histogram bins

Once an economic composite has been created, you can change any setting, except for the **Numeric values** setting in the **Values** tab. Click **OK** to save the composite. You can edit the economic composite by right-clicking on it in the project tree and selecting **Edit Economic Compositing Table**.

If you have created an interval selection from an economic composite, the selection may be deleted if you edit the compositing parameters, along with any dependent objects, such as vein models.

Selecting Values

In the **Values** tab, first select a numeric data column from the **Numeric values** list. A **Query filter** can also be applied.

Handling Missing Intervals and High Grades

The other settings in the **Values** tab determine how missing intervals and high grades are handled.

In economic compositing, drillholes need to be fully informed for all intervals. There are two options to deal with missing intervals: either use a supplied value or an average of the enclosing intervals. **Missing interval handling** offers the options **Use fixed value** and **Use average of enclosing intervals**. Raw assay data should be carefully reviewed and the reasons for the missing data understood before deciding which option to adopt. The most conservative route is to treat missing assays as having a zero grade.

You may choose to **Cap high grades at** a specific value so that anomalously high values do not bias the data. You can also drag the dotted vertical red line on the histogram to adjust this value.

Selecting a Dilution Rule

The **Dilution rule** is set in the **Compositing** tab, and the option you choose will affect which of the other settings in the **Compositing** tab are available and which are mandatory.

The **Dilution rule** selected changes the logic for creating the ore composites. There are three options: **Basic**, **Advanced** and **Advanced+**.

Basic uses a simple length-weighted average of the composite and the candidate waste-ore section and will tend to produce longer waste and ore composites. **Advanced** and **Advanced+** are generally more conservative in that they provide greater control over waste dilution of ore. Both **Advanced** and **Advanced+** will tend to produce more discrete ore composites. With **Advanced+**, an additional rule checks to ensure that adding a waste-ore section does not create internal sections comprising waste-ore-waste segments that are below the cut-off grade.

Setting the Cut-Off Grade

The histogram can be used to identify a reasonable **Cut-off grade** setting. If you have positively skewed data, tick **Log scale in x** to get a logarithmic scale to aid in identifying an appropriate cut-off grade.

You can specify the **Cut-off grade** as a number, or you can drag the dotted vertical blue line on the histogram to adjust this value. You will need to adjust this value, as the default is intentionally set high, at the 99th percentile of the data.

Select the **Cut-off grade** only once you have determined how missing values will be handled, in the **Values** tab. See [Handling Missing Intervals and High Grades](#) above.

Two-Pass Compositing

Enable **Composite twice** for a two-pass composite operation, using the same parameters a second time and the waste and ore classification results of the first pass as the input to the second pass. This will tend to consolidate some of the ore composites into longer composites.

Using True Thickness

The **Use true thickness** setting requires the compositing algorithm to composite using true thickness measured perpendicular to a specified reference plane. **Dip** and **Dip azimuth** specify the orientation of this reference plane, which may be used to approximate the ore body orientation or some other preferred alignment. In more laminar deposits, such as a vein model, enabling **Use true thickness** will force the length-weighted composite to take into account the true thickness of the vein and weigh the interval based on that thickness rather than the thickness implied from the drillhole. **Use true thickness** can be useful in cases where the drillhole is oblique to the trend of the vein and has recorded a thickness much larger than the actual vein thickness.

The Compositing Process and Parameters

Once you have selected a **Dilution rule** and set the **Cut-off grade**, the other parameters in the **Compositing** tab can be used to further refine the compositing behaviour.

This illustrates a short drillhole with a cut-off grade set to 0.01:

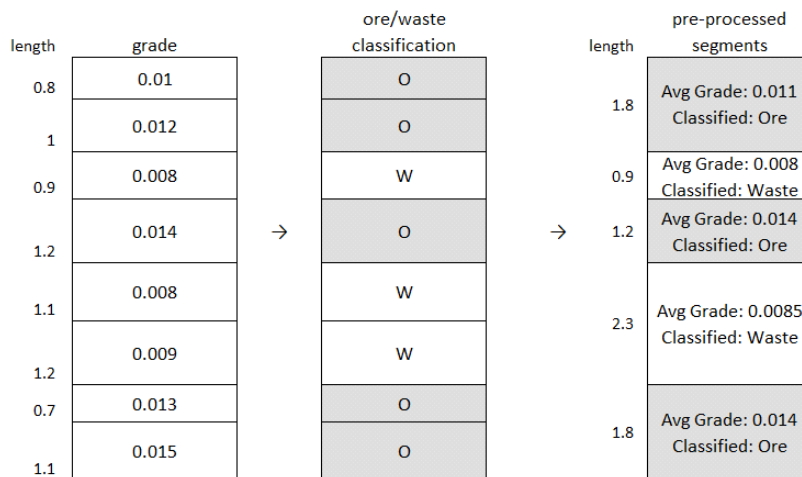

The alternating waste and ore segments are then composited, with the segments being considered for incremental addition to an ore composite sequentially down each drillhole. Although the compositing process produces both ore and waste composites, it only attempts to build ore composites. Waste composites are produced when a composite fails to meet the constraints required for an ore composite, or as initial or final segments.

Within an ore composite, the amount of waste that is allowed to dilute the ore is constrained by the remaining options. Because an ore composite must start in a segment classified as ore and must also end in ore, building an ore composite candidate starts with the next ore segment in the drillhole. An attempt is made to extend the ore composite candidate by adding segments, and because an ore composite must end in ore, not only is the next waste segment added but also the ore segment after that.

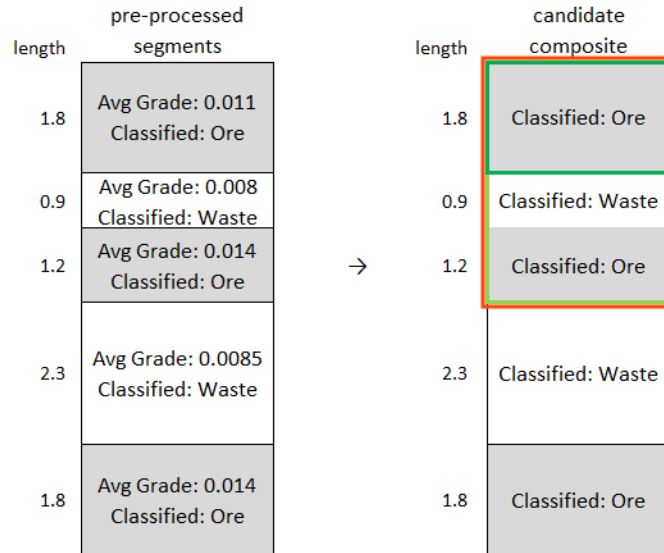

Min. ore composite length specifies the minimum length for an ore composite. If a composited length of ore does not meet this threshold, it will be added to the previous waste composite. This is often intended to reflect a minimum mineable interval. In the above example, the **Min. ore composite length** would need to be at least 3.9, the sum of the 1.8, 0.9 and 1.2 length sections, for the candidate ore composite to be accepted.

Before extending the candidate ore composite with the next waste-ore pair of segments, this combination needs to be tested against any active constraints, the **Max. included waste** and **Max. consecutive waste**. In this illustration, the candidate ore composite has already been extended to include the first three segments and now the addition of the next waste-ore pair of segments is being tested.

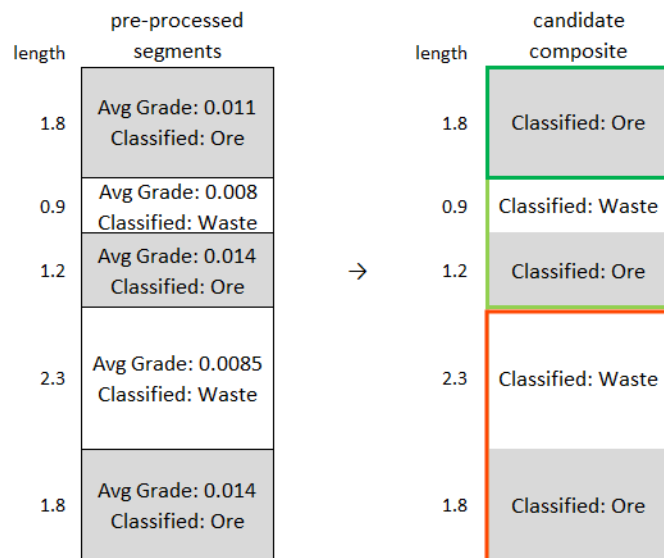

Max. included waste is an optional threshold that constrains the total length of waste that can be accumulated within an ore composite. Increasing this value will permit greater dilution of ore with waste before the candidate ore section will be rejected. If the **Max. included waste** is more than 3.2, the sum of the 0.9 and 2.3 length waste segments, the extension will be permitted. On the other hand, if **Max. included waste** was less than 3.2, the previously accumulated ore candidate would be composited as ore without the addition of the current waste-ore pair of segments.

Max. consecutive waste is an optional threshold for **Basic** and **Advanced** dilution rules, but is required for **Advanced+**. It constrains the length of consecutive intervals classified as waste that can be considered for addition to an ore composite. Increasing this value will permit a longer consecutive waste segment to dilute a candidate ore section before the candidate is rejected as waste. Again using the illustration above, **Max. consecutive waste** would have to be more than 2.3, the longest of the waste segments in the ore composite candidate, to permit the extension of the new waste-ore pair of segments. If **Max. consecutive waste** was less than 2.3, the previously accumulated ore candidate would be composited as ore without the addition of the current waste-ore pair of segments.

If these optional tests pass, the candidate ore composite and the waste-ore section being added to it are also tested against the other dilution rules. If the dilution rules permit the waste-ore section to be added to the candidate ore composite, the section is concatenated to the candidate ore composite. Then the next waste-ore pair of segments is considered to see if the candidate ore composite can be extended further.

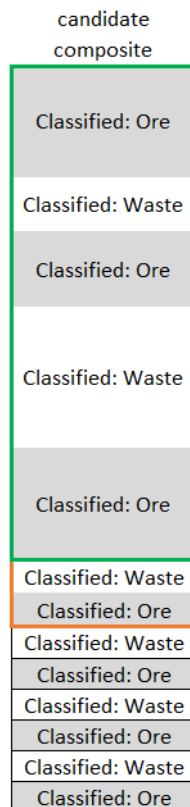

If the new waste-ore section fails the threshold tests or the dilution rule, the current candidate ore composite without the addition of the waste-ore section is tested against additional thresholds: is its length over the **Min. ore composite length**, or otherwise is the composite able to be kept because it meets the **Min. linear grade** threshold to **Keep short high grade ore**

composites? Keep short high grade ore composites is an option that allows ore composites shorter than the **Min. ore composite length**, provided the **Min. linear grade** is exceeded. Linear grade is the length * grade. This allows a short length of high economic value material to be classified as ore and identified. If the current candidate ore composite can meet one of these thresholds, the ore composite is added to the composite table, the waste segment of the current waste-ore segment is considered a candidate waste composite, and the ore segment is used to start a new candidate ore composite. If any of these requirements for keeping the candidate ore composite are not met, the candidate ore composite fails, so the whole candidate composite is considered a waste composite instead of ore, and is added to any preceding candidate waste composite, along with the next waste segment in the drillhole. Compositing resumes with the next ore segment in the drillhole.

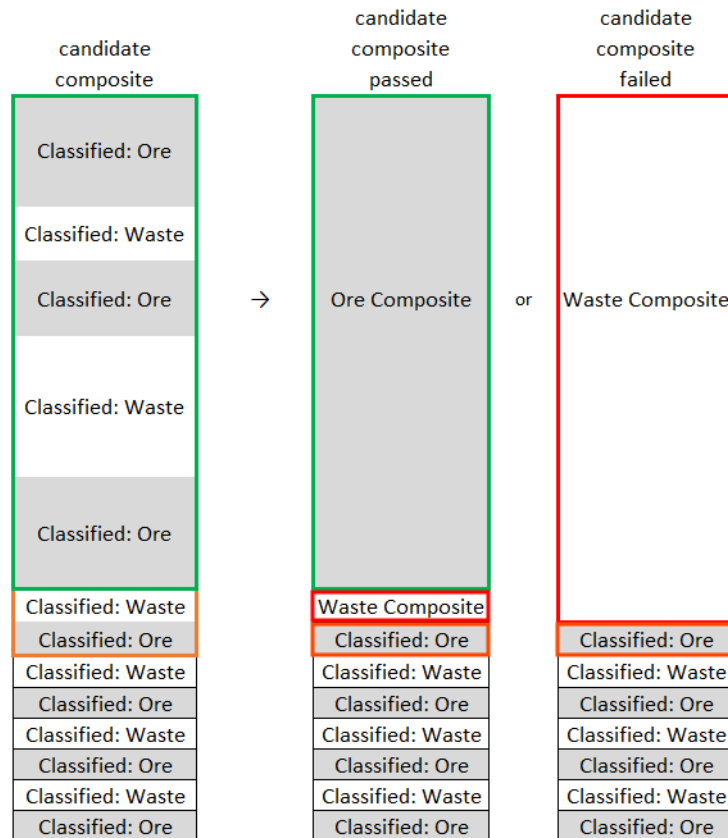

Min. waste composite length does not apply to the **Basic** dilution rule, but is an option for **Advanced** and **Advanced+**. It specifies the preferred minimum length of waste composite. This is applied after initial compositing to any waste composite that is bounded on both sides by ore. Waste composites are expanded into the surrounding ore composites by re-classifying of adjacent intervals as waste until the **Min. waste composite length** is satisfied, in such a way that loss from the ore composites is minimised. The expansion of the waste composite is not applied if it would affect other configured ore requirements such as **Min. ore composite length**.

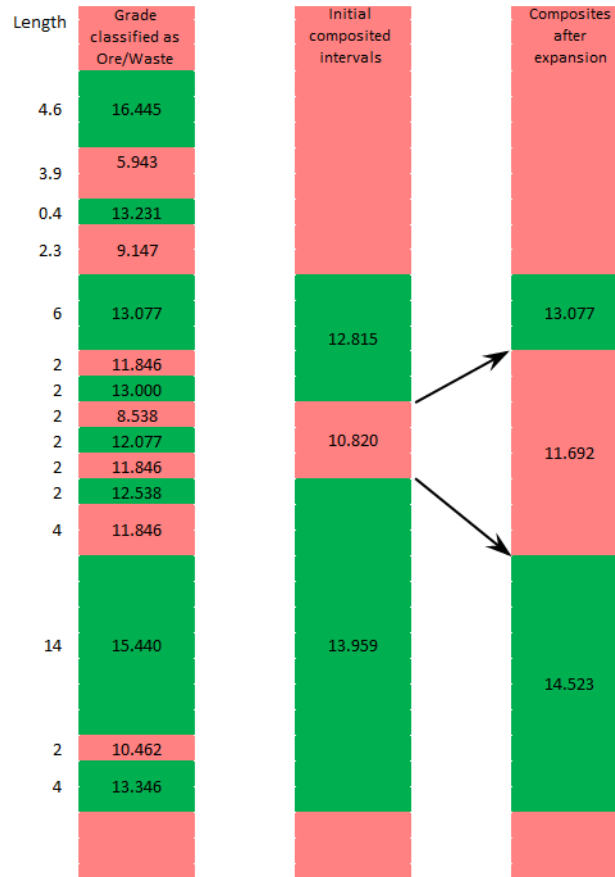

In the above illustration, the centre column depicts the initial status of composites prior to assessment against a **Min. waste composite length** of 20. Because the waste composite in the centre with a grade of 10.280 only has a length of 6, this waste composite will be expanded, taking segments off the surrounding ore composites. The original segments can be seen in the left column. The waste-ore pair of segments above the waste composite are added to it, and the ore-waste pair of segments below it. This gives a length for the expanded waste composite of 16. Given a **Min. ore composite length** of 5, the expansion stops, as the ore composite above the expanded waste composite has only a single ore segment in it, and if the ore-waste segment pair below was added to the expanded waste composite this would create an ore composite shorter than the **Min. ore composite length**.

Viewing Compositing Results

To view the composited data, double-click on the table in the project tree. The table includes the status category column and true_length, linear_grade, dilution_true_length, dilution_linear_grade and pct_missing numeric columns.

id	holeid	from	to	AG_gpt	status	true_length	linear_grade	dilution_true_length	dilution_linear_grade	pct_missing
123	WP013	174.0	184.0	0.98	Waste	10.0	9.8	0.0	0.0	0
124	WP013	184.0	188.0	1.775	Ore	4.0	7.1	0.0	0.0	0
125	WP013	188.0	200.0	0.85	Waste	12.0	10.2	0.0	0.0	0
126	WP014	0.0	8.0	0.316	Waste	8.0	2.528	0.0	0.0	0
127	WP014	8.0	134.0	3.411111...	Ore	126.0	429.8	52.0	53.7	0
128	WP014	134.0	148.0	0.828571...	Waste	14.0	11.6	0.0	0.0	0
129	WP014	148.0	152.0	1.675	Ore	4.0	6.7	0.0	0.0	0
130	WP014	152.0	182.0	0.98	Waste	30.0	29.4	0.0	0.0	0
131	WP014	182.0	190.0	1.6875	Ore	8.0	13.5	2.0	2.9	0
132	WP014	190.0	192.0	1.1	Waste	2.0	2.2	0.0	0.0	0
133	WP014	192.0	196.0	1.575	Ore	4.0	6.3	0.0	0.0	0
134	WP014	196.0	200.0	0.925	Waste	4.0	3.7	0.0	0.0	0
135	WP014	200.0	202.0	1.75	Ore	2.0	3.5	0.0	0.0	0
136	WP015	0.0	1.0	0.01	Waste	1.0	0.01	0.0	0.0	0
137	WP015	1.0	22.0	2.754761...	Ore	21.0	57.85	2.0	2.3	0
138	WP015	22.0	40.0	0.716666...	Waste	18.0	12.9	0.0	0.0	0
139	WP015	40.0	48.0	1.725	Ore	8.0	13.8	0.0	0.0	0
140	WP015	48.0	56.0	0.95	Waste	8.0	7.6	0.0	0.0	0
141	WP015	56.0	98.0	1.745238...	Ore	42.0	73.3	18.0	17.9	0
142	WP015	98.0	104.0	1.066666...	Waste	6.0	6.4	0.0	0.0	0
143	WP015	104.0	106.0	1.95	Ore	2.0	3.9	0.0	0.0	0
144	WP015	106.0	110.0	1.1	Waste	4.0	4.4	0.0	0.0	0
145	WP015	110.0	112.0	1.7	Ore	2.0	3.4	0.0	0.0	0

The true_length is the total length of the interval. If **Use true thickness** was enabled, that calculated value will be used here instead of the drillhole interval length. The linear_grade is the grade * length of the material of interest excluding any dilution material.

The dilution_true_length is the total length of diluting intervals for the composite interval. The dilution_linear_grade is the linear grade * length of all the diluting material in a composite interval. For composite intervals graded as ore, these are the length and linear grade of the waste that dilutes the ore in the interval. For a waste composite interval, the dilution true length and dilution linear grade are the length and linear grade of the ore that dilutes the waste.

The pct_missing value shows the percentage of the composite that is based on missing (and then filled) interval data.

It is useful to use the drillhole correlation tool to visualise the resulting composited data. Here a new drillhole correlation has been created with a single selected collar (highlighted in the table above), with the source numeric column dragged in from the assay folder, along with the data columns from the economic composite.

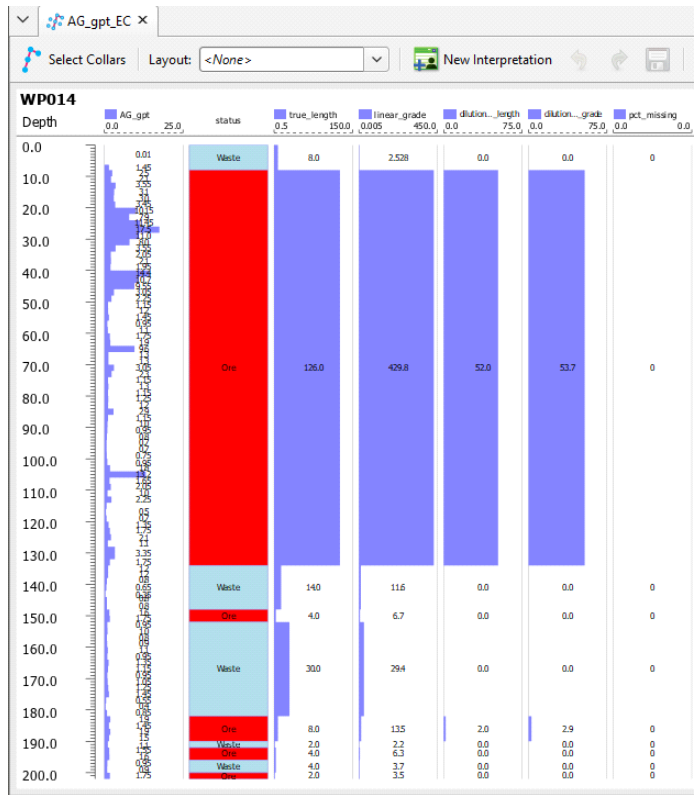

To learn more about how to use the drillhole correlation tool, see [Drillhole Correlation Tool](#).

The drillhole correlation tool can also be useful for observing and comparing the differences between different economic compositing options. In the following example, the effects of the **Basic**, **Advanced**, and **Advanced+** dilution rules on a dataset are being compared, as well as the effect of the **Composite twice** option on each rule.

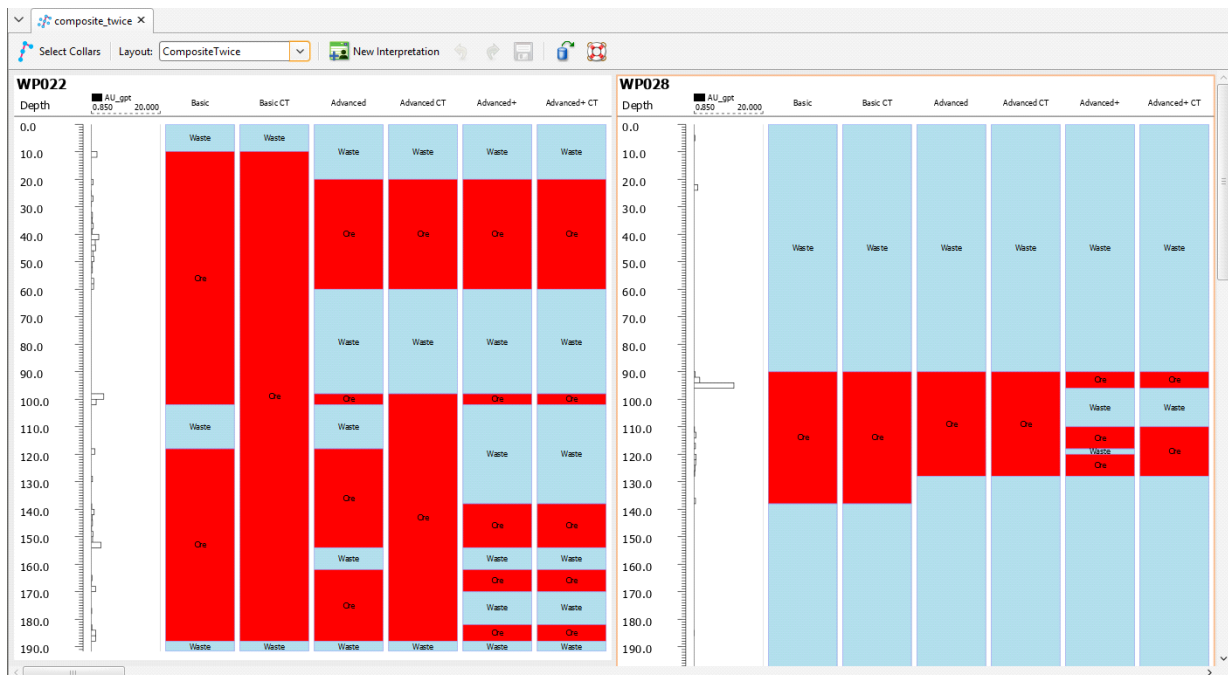

Majority Composites

Category data can be composited into interval lengths from another table or into fixed interval lengths. The compositing is based on a majority percentage where each interval is assigned a category based on the category that makes up the highest percentage of the new interval. If two categories are equally represented, the category that occurs further up the drillhole (closest to the collar) is assigned.

This is useful for comparing lithology and assay data; the intervals from an assay table can be applied to a category column to produce a new lithology column with the shorter intervals typical of assay tables. The majority composite column can then be used to create a merged table containing both lithology and assay data.

Drillhole data is composited from the **Composites** folder, which is in the project tree as part of the **Drillholes** object. To create a majority composite, right-click on the **Composites** folder and select **New Majority Composite**. The **New Compositing Table** window will appear:

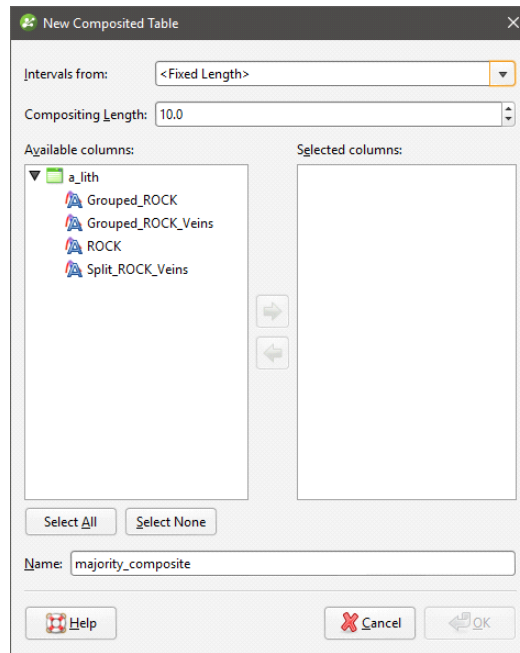

Select the interval table that will be used to specify the intervals for the new majority composite or specify a fixed **Compositing Length**. Next, select the columns that will be composited. Click **OK** to create the composite. The composite will be added to the **Composites** folder in the project tree. You can edit it by right-clicking on it and selecting **Edit Compositing Table**.

Here assay intervals are shown inside the much longer lithology intervals. The selected interval goes from 14.0 to 23.7 metres:

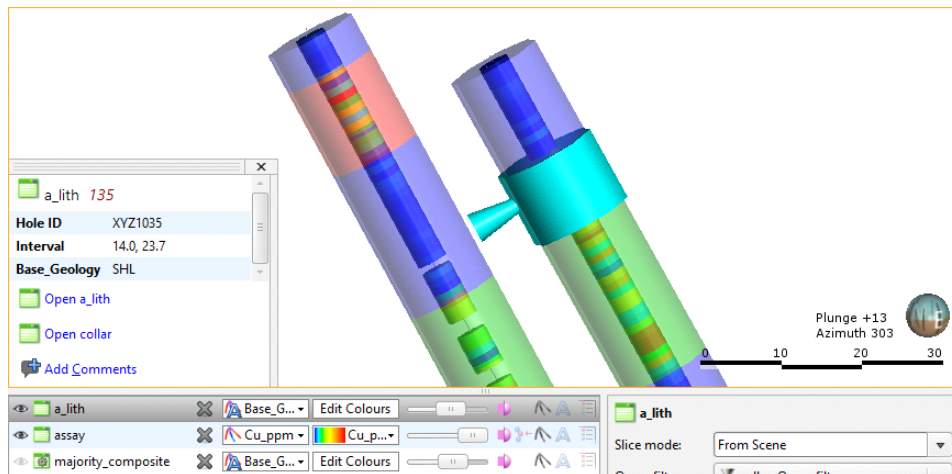

Here a majority composite has been created based on the lithology table using the assay table intervals. The category column displayed in the scene appears similar to the category column used to create it, but selecting an interval in the scene shows that the lithology has been composited into smaller intervals that match the assay intervals:

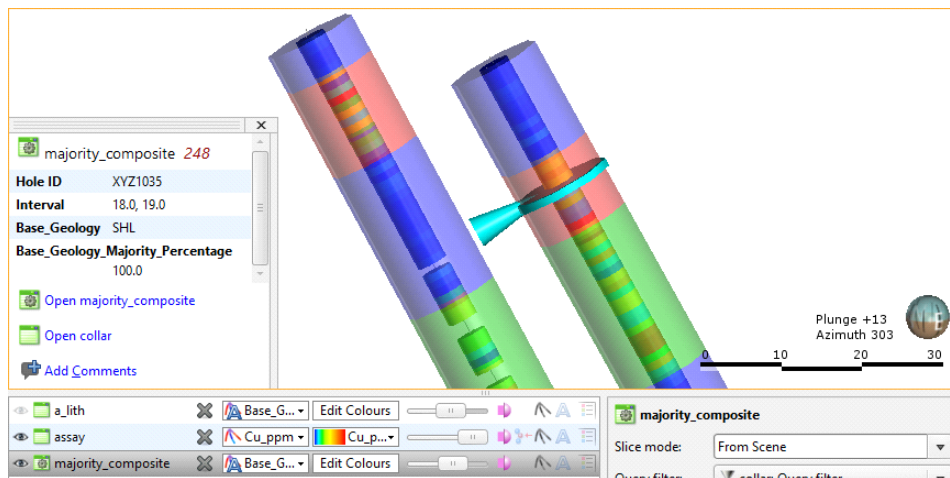

Viewing Majority Composite Statistics

Once you have created a composited table, you can view statistics on the table. To do this, right-click on it and select **Statistics**. The following options are available:

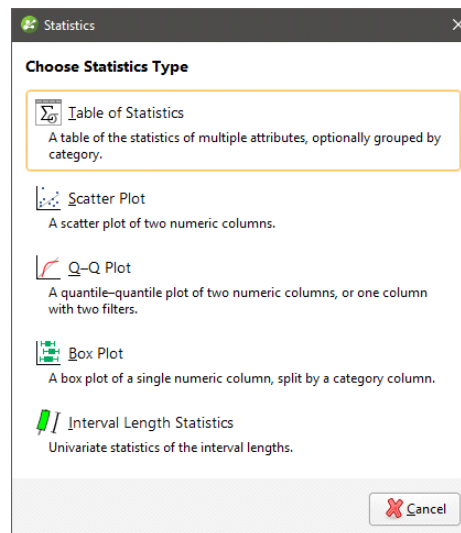

See the [Analysing Data](#) topic for more information on each option:

- [Table of Statistics](#)
- [Scatter Plots](#)
- [Q-Q Plots](#)
- [Box Plots](#)

The **Interval Length Statistics** graph is a univariate graph, so for more information on the options available, see [Univariate Graphs](#) in the [Analysing Data](#) topic.

Right-click on the numeric columns and select **Statistics** to view information about the composited values. See [Univariate Graphs](#) in the [Analysing Data](#) topic for more information.

Numeric Composites

Compositing numeric data takes unevenly-spaced drillhole data and turns it into regularly-spaced data, which is then interpolated. Compositing parameters can be applied to entire drillholes or only within a selected region of the drillhole. For example, you may wish to composite Au values only within a specific lithology.

There are two approaches to compositing numeric data in Leapfrog Geo:

- Composite the drillhole data directly. This creates a new interval table that can be used to build models, and changes made to the table will be reflected in all models based on that table. This process is described below.
- Composites the points used to create an interpolant. This is carried out by generating an interpolant and then setting compositing parameters for the interpolant's values object. This isolates the effects of the compositing as the compositing settings are only applied to the interpolant.

Intervals that have no data can have a significant effect when compositing data as they are ignored by the compositing algorithm. The effect of these missing intervals can be managed using the **Minimum coverage** parameter, but it's best to assign special values where intervals have no data. For example, intervals that are missing data can be assigned a value of 0 or that of the background mineralisation. See [Handling Special Values](#) for more information.

The rest of this topic describes compositing drillhole data directly. It is divided into:

- [Creating a Numeric Composite](#)
- [Selecting the Compositing Region](#)
- [Compositing Parameters](#)
- [Viewing Numeric Composite Statistics](#)

Creating a Numeric Composite

To create a numeric composite, right-click on the **Composites** folder and select **New Numeric Composite**. The **New Composited Table** window will appear:

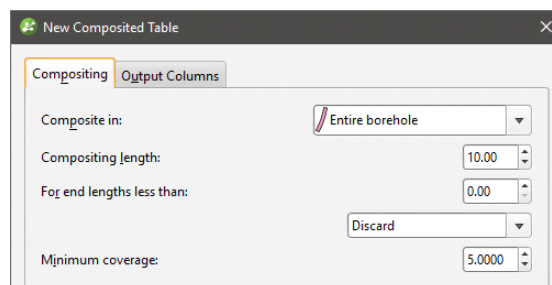

Set the compositing region and parameters; this is described in detail below. Then click on the **Output Columns** tab to select from the available columns of numeric data. Click **OK** to create the table.

Double-clicking on the table displays the data in its columns. Edit the table by right-clicking on it and selecting **Edit Composited Table**.

Selecting the Compositing Region

Compositing parameters can be applied to entire drillholes or only within a selected region of the drillhole. There are four options for selecting the region in which numeric data will be composited, and each is discussed below.

Compositing in the Entire Drillhole

For this option, **Compositing Parameters** are applied to all values down the length of drillholes. Select **Entire drillhole**, then set the compositing parameters.

Compositing in a Subset of Codes

If you wish to select specific category codes in which to composite numeric data, there are two options:

- **Subset of codes, grouped**
- **Subset of codes, ungrouped**

The difference between the two is that for the grouped option, the selected codes are combined and the same **Compositing Parameters** are applied to the grouped intervals:

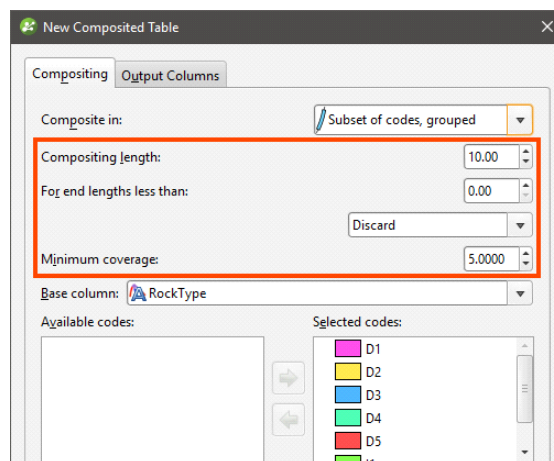

For the ungrouped option, however, you can set compositing parameters for each code in the selected **Base column**:

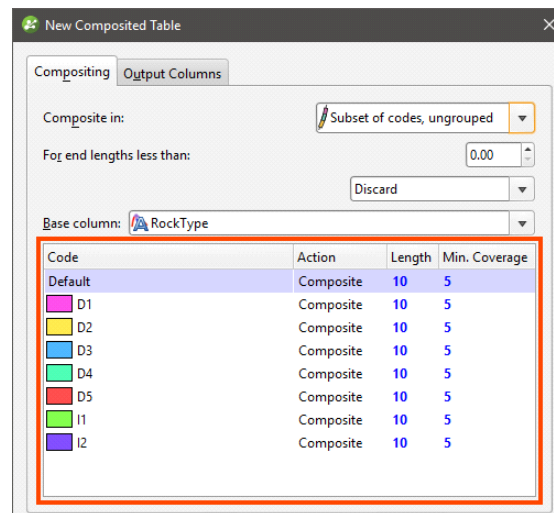

For the **Action** column, the options are:

- **Composite.** Numeric data that falls within the selected code will be composited according to the parameters set.
- **No compositing.** Numeric data is not composited within the selected code. The raw data will be used in creating the new data table.
- **Filter out.** Numeric data within the selected code will not be included in the new data table.

Compositing in Intervals

For the **Intervals from table** option, the interval lengths from the **Base table** are used to determine composite lengths. The value assigned to each interval is the length-weighted average value, and there are no further compositing parameters to set.

Compositing Parameters

When the compositing region is **Entire drillhole**, **Subset of codes, grouped** or **Subset of codes, ungrouped**, the interval lengths are determined by applying three compositing parameters. These parameters are applied as follows:

- The drillholes are divided into intervals wherever numeric data occurs. The **Compositing length** determines the length of each composite interval, and the **Minimum coverage length** determines whether or not residual segments (those shorter than the **Compositing length**) are retained for further processing. Composite lengths are generated from the collar down the drillhole, so any residual segments produced will be at the bottom of the drillhole and where there is data missing down the length of the drillhole. How residual segments are handled is described below.

Intervals that have no data can have a significant effect when compositing data as they are ignored by the compositing algorithm. The effect of these missing intervals can be managed using the **Minimum coverage** parameter, but it's best to assign special values where intervals

have no data. For example, intervals that are missing data can be assigned a value of 0 or that of the background mineralisation. See [Handling Special Values](#) for more information.

- The **For end lengths less than** parameter is applied to determine what happens to the residual segments that may result from applying the **Compositing length** and **Minimum coverage** parameters. The three possibilities are [Discard](#), [Add to Previous Interval](#) and [Distribute Equally](#).
- Composite values are calculated for each composite interval. This is simply the length-weighted average of all numeric drillhole data that falls within the composite interval.
- Composite points are generated at the centre of each composite interval from the composite values.

Discard

With the **Discard** option, residual segments that meet or exceed the **Minimum coverage** length are retained; those shorter are discarded.

For example, consider two drillholes. A is 49 metres long and B is 44 metres long. The **Compositing length** is set to 10 and the **For end lengths less than** length is set to 5. There will be a residual segment 9 metres long for Drillhole A and one 4 metres long for Drillhole B. Drillhole A's residual segment will be retained as a segment, whereas Drillhole B's residual segment will be discarded. This results in:

- Drillhole A: 10m, 10m, 10m, 10m, 9m (residual length > **Minimum coverage** length so the 9m segment is kept)
- Drillhole B: 10m, 10m, 10m, 10m (residual length < **Minimum coverage** length so the 4m segment is discarded)

Add to Previous Interval

With the **Add to previous interval** option, the **Minimum coverage** length is automatically set to zero. Residual segments longer than the **For end lengths less than** value are retained as separate segments; those shorter are added to the previous interval.

For our two drillholes, when the **Compositing length** is 10, there will be a residual segment 9 metres long for Drillhole A and one 4 metres long for Drillhole B. When **For end lengths less than** is set to 5, Drillhole A's residual segment will be retained as a segment, whereas Drillhole B's residual segment will be added to the previous interval. This results in:

- Drillhole A: 10m, 10m, 10m, 10m, 9m (residual length > **For end lengths less than** length so the 9m length is kept as a separate segment)
- Drillhole B: 10m, 10m, 10m, 14m (residual length < **For end lengths less than** length so the 4m segment is added to the previous interval)

Distribute Equally

With the **Distribute equally throughout drillhole** option, the **Minimum coverage** parameter is automatically set to zero. Residual segments longer than the **For end lengths less than** value

are retained as separate segments; those shorter will have their length distributed among the other intervals.

For our two drillholes, Drillhole A's residual segment will be retained as an individual segment, whereas Drillhole B's residual segment will have its length distributed among the rest of the intervals. The segments for each composited drillhole will be:

- Drillhole A: 10m, 10m, 10m, 10m, 9m (residual length > **For end lengths less than** length so the 9m segment is kept as a separate segment)
- Drillhole B: 11m, 11m, 11m, 11m (residual length < **For end lengths less than** length so the 4m length is distributed among the other intervals)

Viewing Numeric Composite Statistics

Once you have created a composited table, you can view statistics on the table or for each individual column in the table.

To view statistics for the table, right-click on it and select **Statistics**.

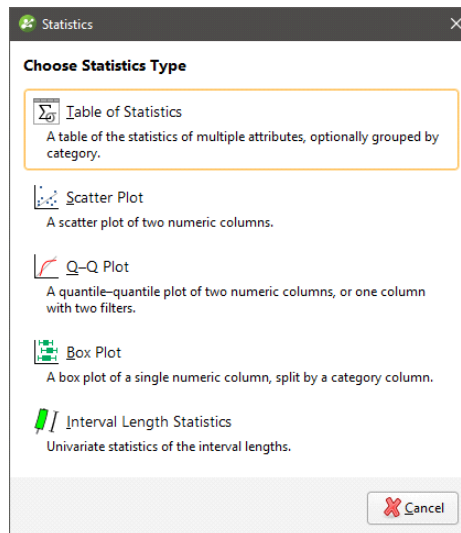

See the [Analysing Data](#) topic for more information on each option:

- [Table of Statistics](#)
- [Scatter Plots](#)
- [Q-Q Plots](#)
- [Box Plots](#)

The **Interval Length Statistics** graph is a univariate graph, so for more information on the options available, see [Univariate Graphs](#) in the [Analysing Data](#) topic.

Right-click on the table columns and select **Statistics** to view information about the composited values.

The first option displays statistics on the composited values; see [Univariate Graphs](#) in the [Analysing Data](#) topic for more information. The other two options display statistics comparing data before and after compositing.

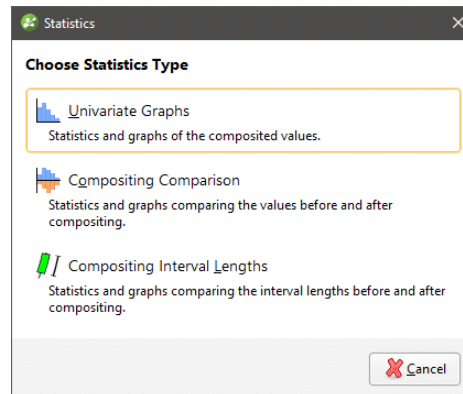

Compositing Comparison

The double histogram, one displaying the distribution of the raw data and one displaying the distribution of the composited data, enables comparison of the two distributions of the same element before and after the compositing transformation. Impacts on the symmetry of distributions will be evident.

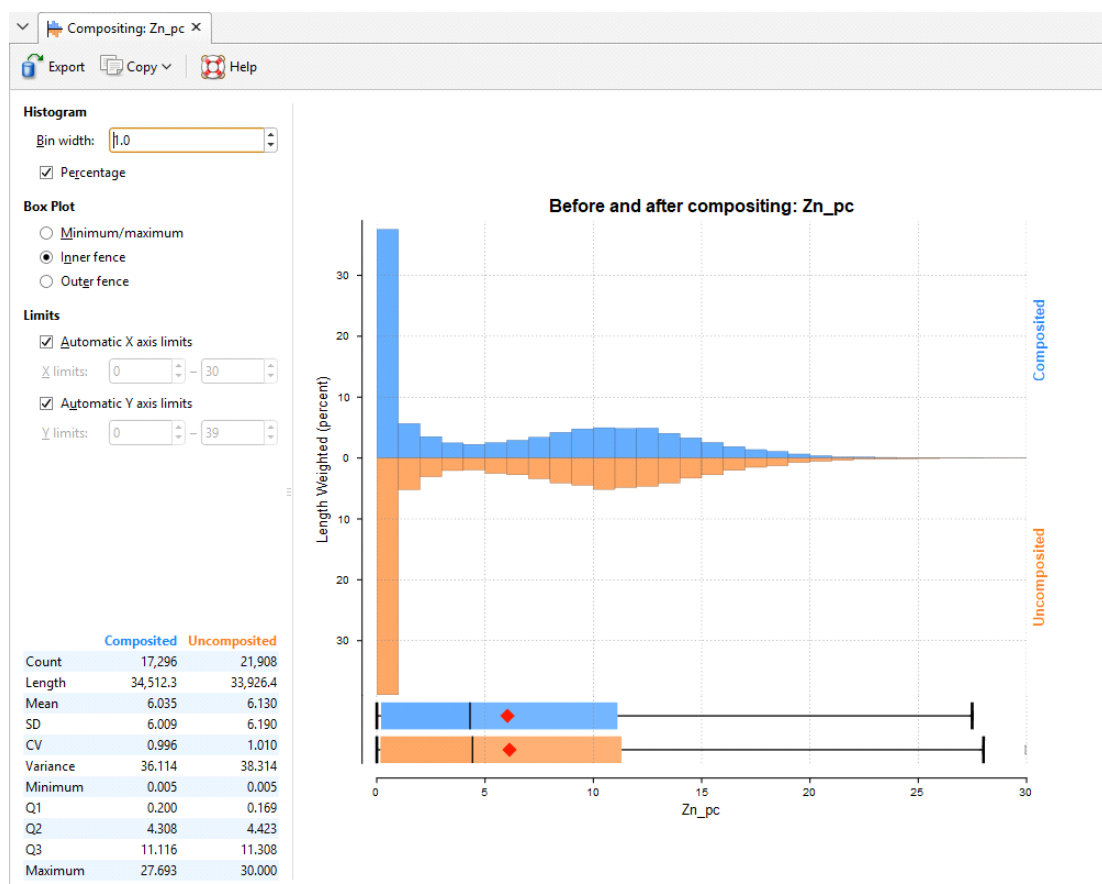

In the **Histogram** settings, **Bin width** changes the size of the histogram bins used in the plot. **Percentage** is used to change the Y-axis scale from a length-weighted scale to a percentage scale.

The **Box Plot** options control the appearance of the box plot drawn under the primary chart. The whiskers extend out to lines that mark the extents you select, which can be the **Minimum/maximum**, the **Inner fence** or the **Outer fence**. Inner and outer values are defined as being 1.5 times the interquartile range and 3 times the interquartile range respectively.

The **Limits** fields control the ranges for the X-axis and Y-axis. Select **Automatic X axis limits** and/or **Automatic Y axis limits** to get the full range required for the chart display. Untick these and manually adjust the **X limits** and/or **Y limits** to constrain the chart to a particular region of interest. This can effectively be used to zoom the chart.

The bottom left corner of the chart displays a table with a comprehensive set of statistical measures for the data set.

Compositing Interval Lengths

This graph shows a double histogram of distributions of the interval lengths before and after compositing.

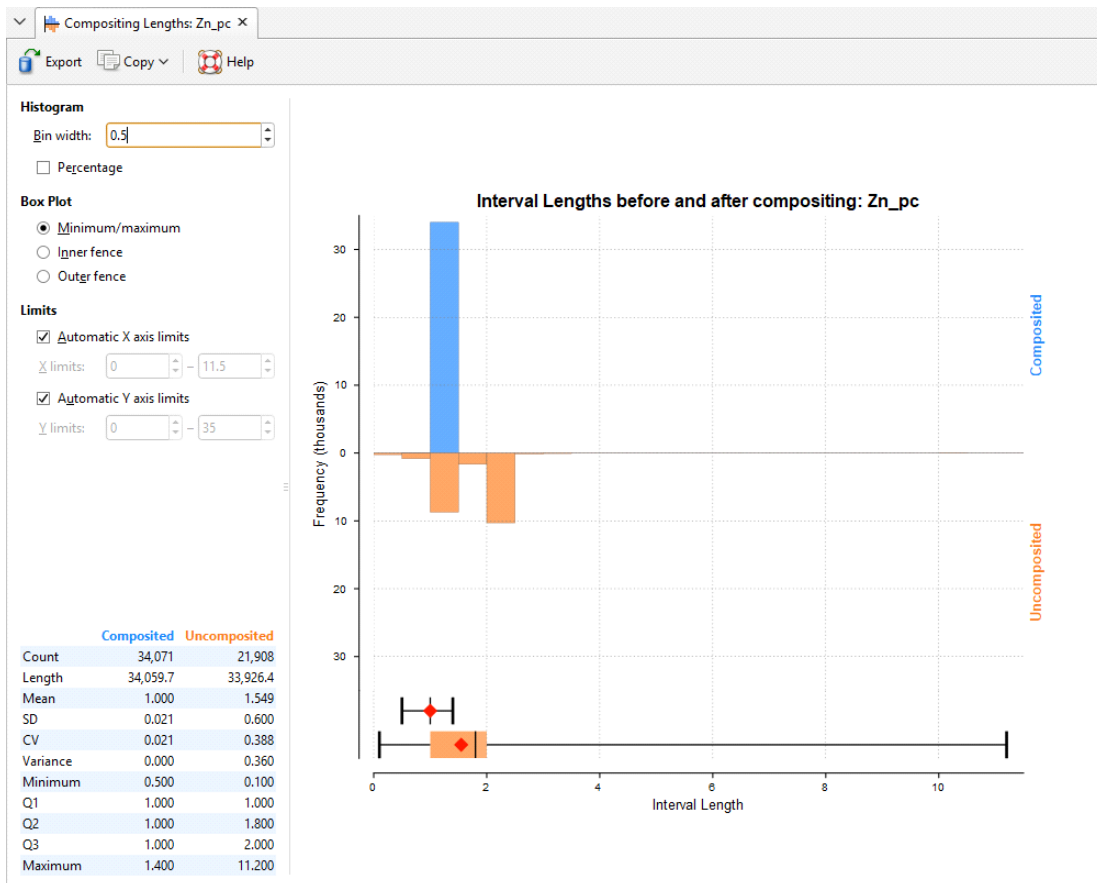

In the **Histogram** settings, **Bin width** changes the size of the histogram bins used in the plot. **Percentage** is used to change the Y-axis scale from a length-weighted scale to a percentage scale.

The **Box Plot** options control the appearance of the box plot drawn under the primary chart. The whiskers extend out to lines that mark the extents you select, which can be the **Minimum/maximum**, the **Inner fence** or the **Outer fence**. Inner and outer values are defined as being 1.5 times the interquartile range and 3 times the interquartile range respectively.

The **Limits** fields control the ranges for the X-axis and Y-axis. Select **Automatic X axis limits** and/or **Automatic Y axis limits** to get the full range required for the chart display. Untick these

and manually adjust the **X limits** and/or **Y limits** to constrain the chart to a particular region of interest. This can effectively be used to zoom the chart.

The bottom left corner of the chart displays a table with a comprehensive set of statistical measures for the data set.

Grouping Lithologies

The group lithologies tool lets you define a new unit to which existing units are added. For example, a sandstone deposit might appear in an interval table as poorly-sorted and well-sorted units. With the group lithologies tool, you can group both units into a single sandstone unit.

When you group lithologies, the original lithology column is preserved and a new lithology column is added to the interval table. You can then select the original lithology column or the new one when displaying data and creating models.

To start grouping two or more lithologies, right-click on the interval table in the project tree and select **New Column > Group Lithologies**. The **New Lithology Column** window will appear:

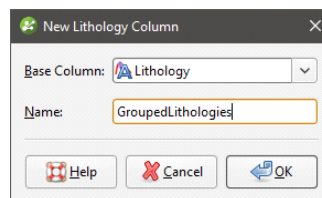

Select the lithology column you wish to use from the **Base Column** list, then enter a **Name** for the new lithology column. Click **OK**.

A window will appear displaying all lithologies in the base lithology column:

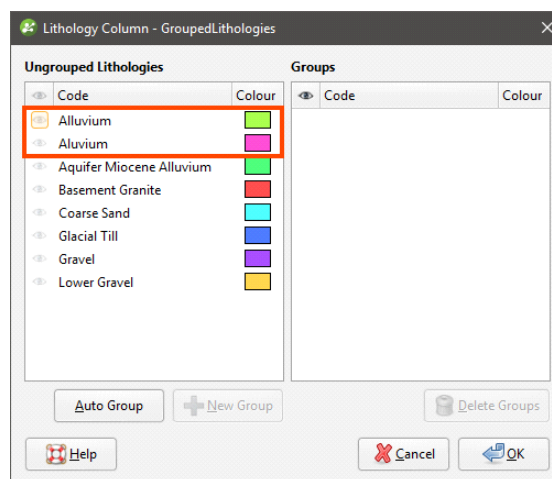

In this example, two spellings of Alluvium have been used and these lithologies should be combined into a single lithology.

The most straightforward way to group lithologies is to select the first of the lithologies, then click **New Group**. A group will be created for the selected lithology with only that lithology as a member:

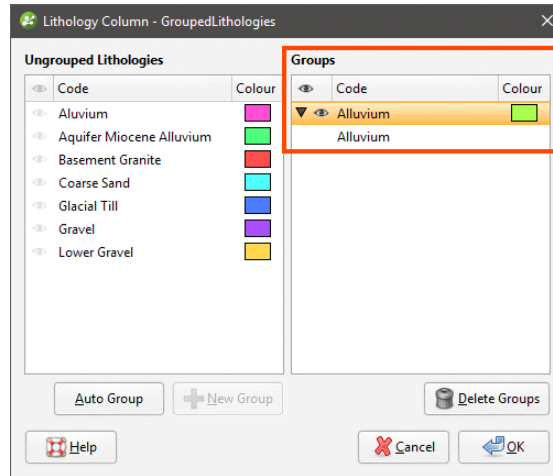

Next, click on a lithology in the **Ungrouped Lithologies** pane and drag it onto the group:

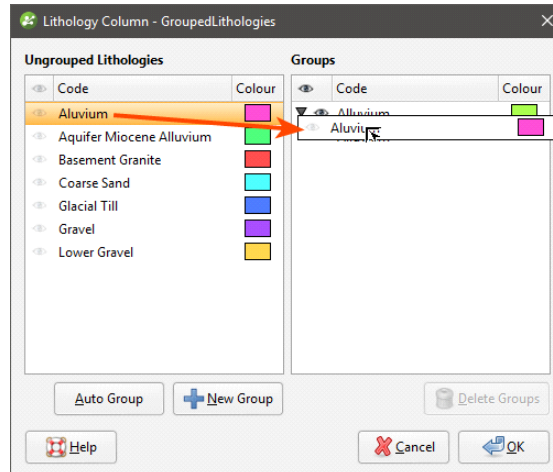

Grouping lithologies creates a new lithology column and any lithologies left in the **Ungrouped Lithologies** pane will be excluded from the new column. For this reason, once you have grouped the required lithologies, move all remaining lithologies to the **Groups** pane by clicking on each lithology, then on the **New Group** button. This will make each remaining lithology a new group with a single member:

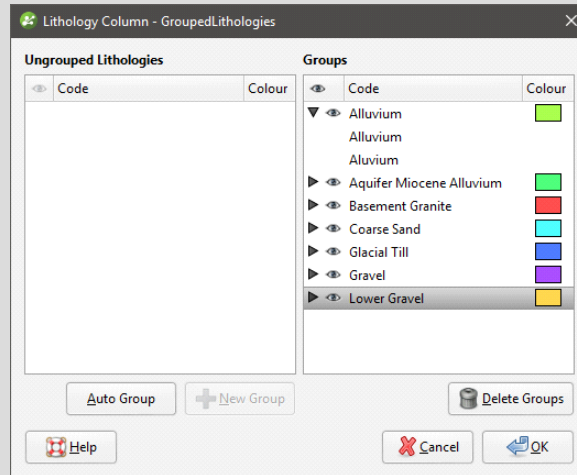

When you are finished, click **OK** to create the new lithology column. It will appear in the project tree as an additional lithology column in the interval table.

Select the new column from the shape list to display it:

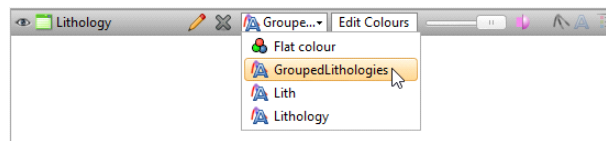

Click on the **Edit** button (🖌️) to start editing the selected column.

The other way to group lithologies is to let Leapfrog Geo create the lithology groups.

Automatic Lithology Groups

Leapfrog Geo can automatically create lithology groups. To do this, create a new lithology column, as described above. Click the **Auto Group** button to reveal more options:

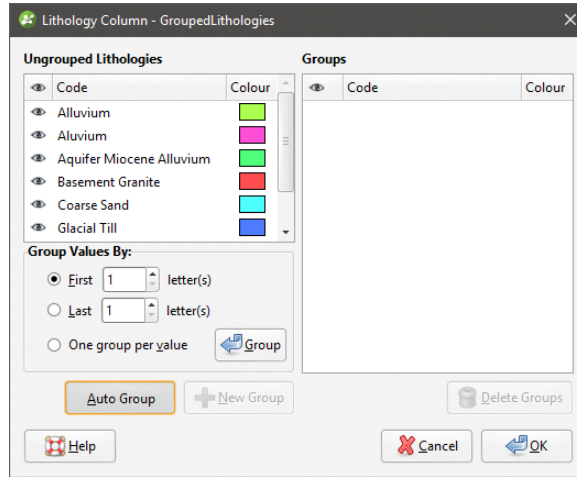

The **First letter(s)** and **Last letter(s)** options let you create groups according the names of the existing lithologies. Click **Group** to create the new groups.

Here, the first two letters have been used to created a new set of lithologies:

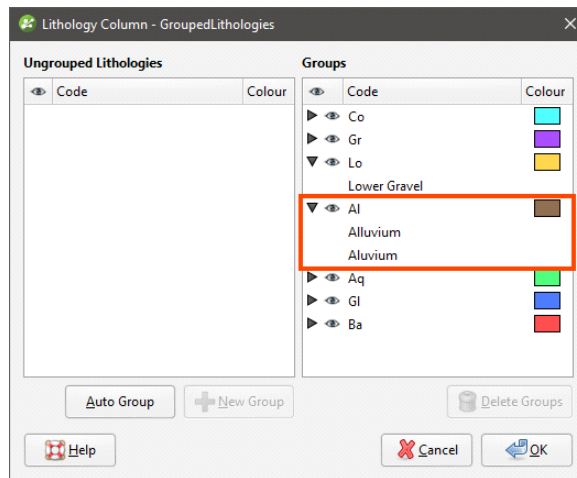

The two alluvium lithologies have been added to a single group.

The **One group per value** option creates a group for each original lithology. You can then drag and drop lithologies into different groups, move lithologies you do not wish to group back into the **Ungrouped Lithologies** pane and use the **Delete Groups** options to remove any empty groups.

Splitting Lithologies

With the split lithologies tool, you can create new units from a single unit by selecting from intervals displayed in the scene. When you split lithologies, the original lithology column is preserved and a new lithology column is added to the interval table. You can then select the original lithology column or the new one when displaying data and creating models.

The difference between the interval selection tool and the split lithologies tool is that with splitting lithologies, you are limited to selecting intervals from a single lithology. If you wish to select intervals from multiple lithologies, see [Interval Selection](#).

To start splitting a lithology, first add the drillhole data to the scene. Then right-click on the interval table in the project tree and select **New Column > Split Lithologies**. The **New Lithology Column** window will appear:

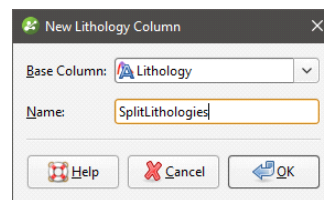

Select the lithology column you wish to use from the **Base Column** list, then enter a **Name** for the new lithology column. Click **OK**.

The **Lithologies and Splits** window will appear, together with a set of tools that will help you to select intervals in the scene:

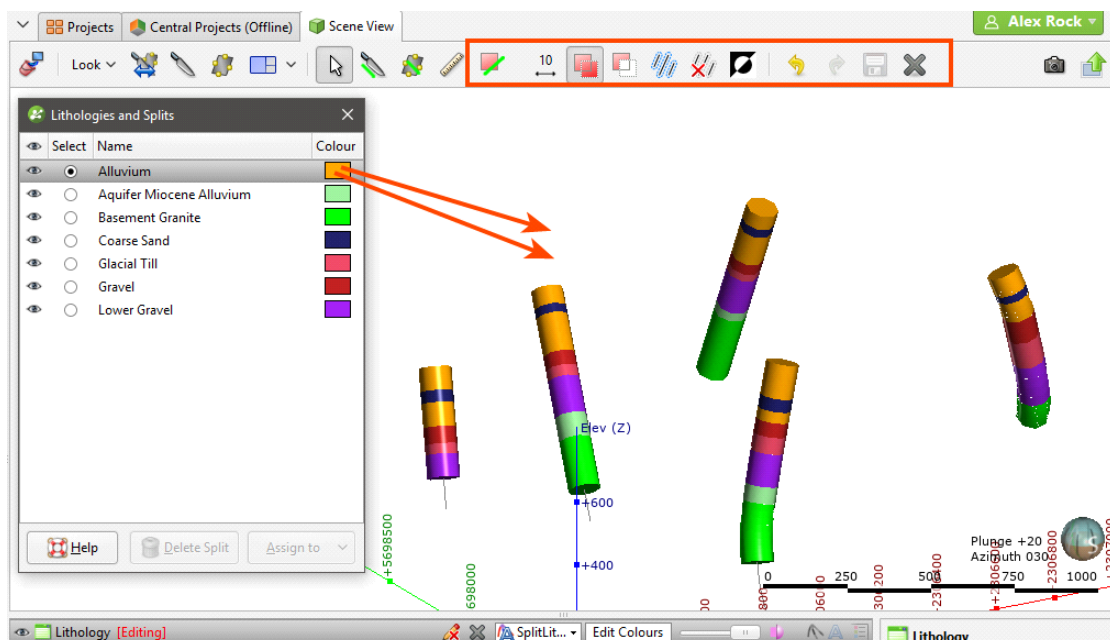

Alluvium (gold) appears both above and below Coarse Sand (blue) and so should be split into two separate lithologies.

The first step is to select the lithology that will be split in the **Lithologies and Splits** window. In the example above, Alluvium is already selected.

Next, click on the **Select Intervals** button (📏) and click the **Add Intervals** button (📏). In the scene, draw a line across each interval you wish to select.

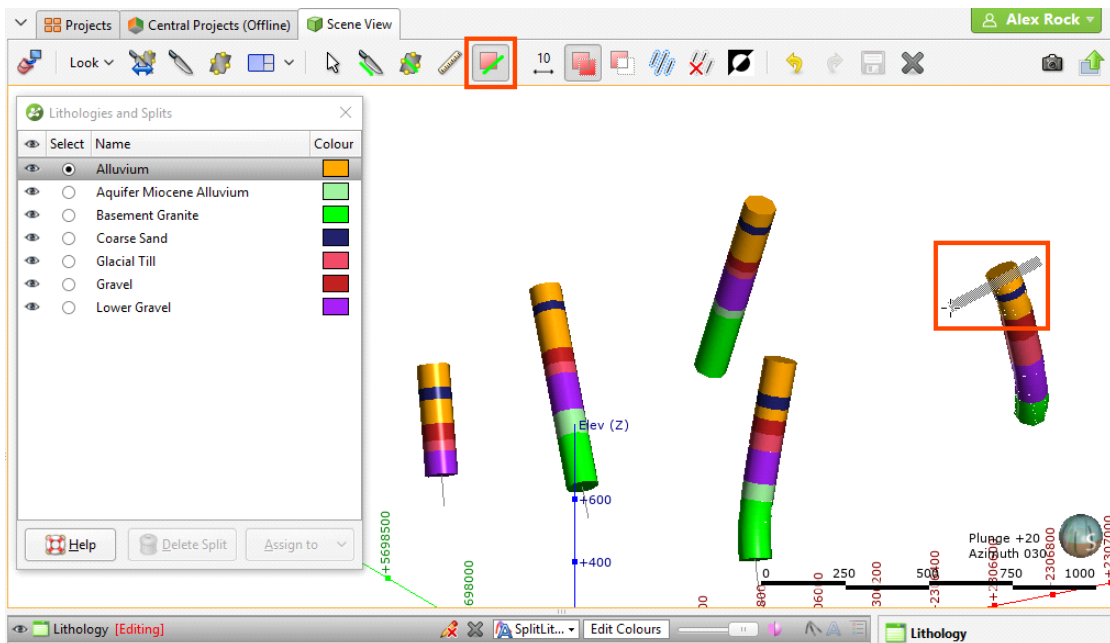

To change the width of the line used to select intervals, click on the **Change Line Width** button (📏) and enter a new value. You can keep the **Set Line Width** window open while you select intervals so you can change the line width as required.

Selected intervals are highlighted in the scene. If you accidentally select the wrong interval, either:

- Click the **Remove Intervals** button (📏) and draw across the interval once again.
- Hold the **Ctrl** key while drawing across the interval.

You can also:

- Select all visible intervals by clicking on the **Select All** button (📏) or by pressing Ctrl+A.
- Clear all selected intervals by clicking on the **Clear Selection** button (📏) or by pressing Ctrl+Shift+A.
- Swap the selected intervals for the unselected intervals by clicking on the **Invert Selection** button (📏) or by pressing Ctrl+I.

Once you have selected some segments, click on the **Assign to** button in the **Lithologies and Splits** window and select **Create New Split**:

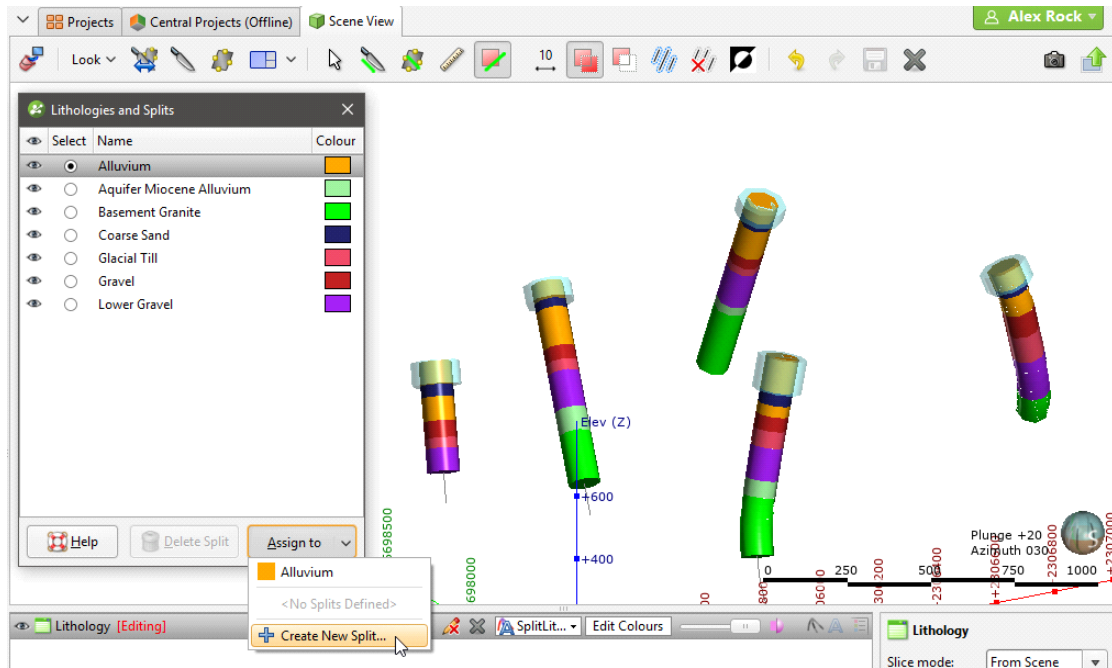

The **New Split** window will appear:

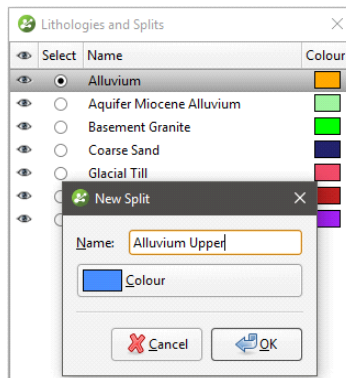

Enter a **Name** for the new lithology, then click **OK**. The new lithology will be created and the scene updated to reflect the changes:

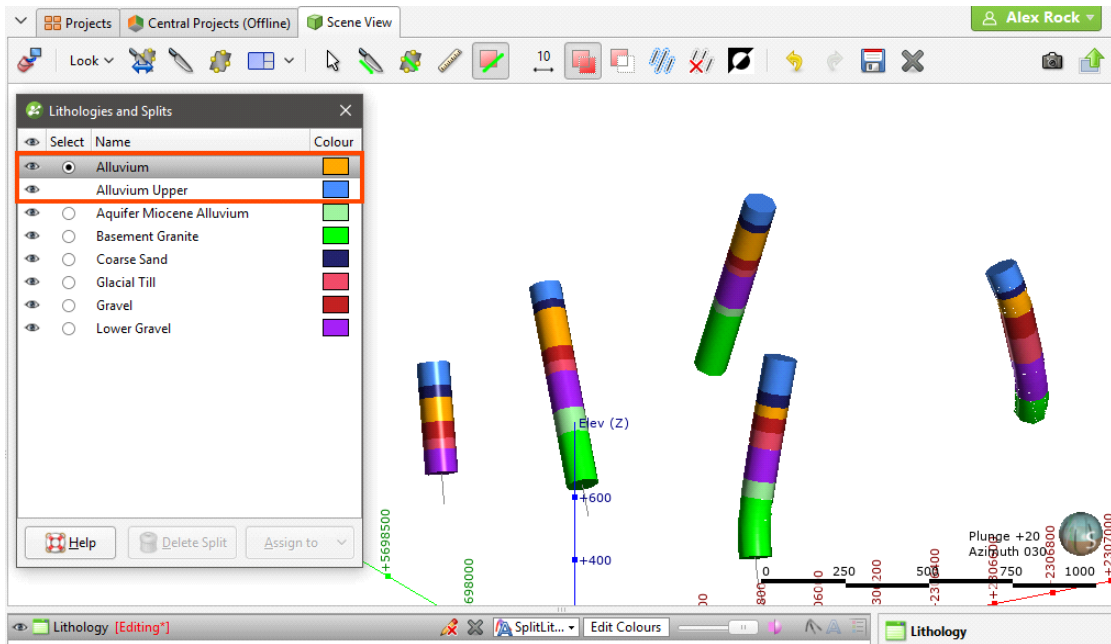

Once you have created a new lithology, you can add to it by selecting intervals, then selecting the lithology from the **Assign to** list.

When you are finished, click the **Save** button (📁) and close the **Lithologies and Splits** window. The new lithology column will appear in the project tree as an additional lithology column in the interval table.

Select the new column from the shape list to display it:

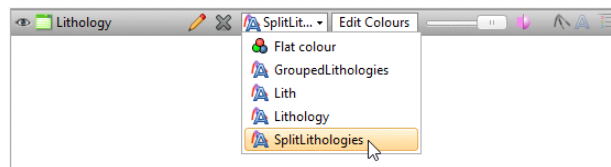

Click on the **Edit** button (🖌️) to start editing the selected column.

Interval Selection

When you wish to select a small portion of intervals or you don't have suitable parameters to use a query filter, you can select intervals from drillholes displayed in the scene to create a new lithology column. The original lithology column is preserved and a new lithology column is added to the interval table. You can then select the original lithology column or the new one when displaying data and creating models.

The difference between the interval selection tool and the split lithologies tool is that with splitting lithologies, you are limited to selecting intervals from a single lithology. With interval selection, you can choose intervals from any lithology displayed in the scene.

To start selecting intervals, first add the drillhole data to the scene. Then right-click on the interval table in the project tree and select **New Column > Interval Selection**. For a merged table, right-click on it and select **Interval Selection**.

The **New Lithology Column** window will appear:

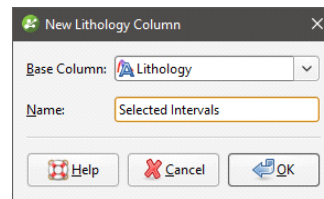

Select the lithology column you wish to use from the **Base Column** list, then enter a **Name** for the new lithology column. Click **OK**.

The **Interval Selection** window will appear, together with a set of tools that will help you to select intervals in the scene. To select intervals, click on the **Select Intervals** button (📏) and click the **Add Intervals** button (📏). In the scene, draw a line across each interval you wish to select:

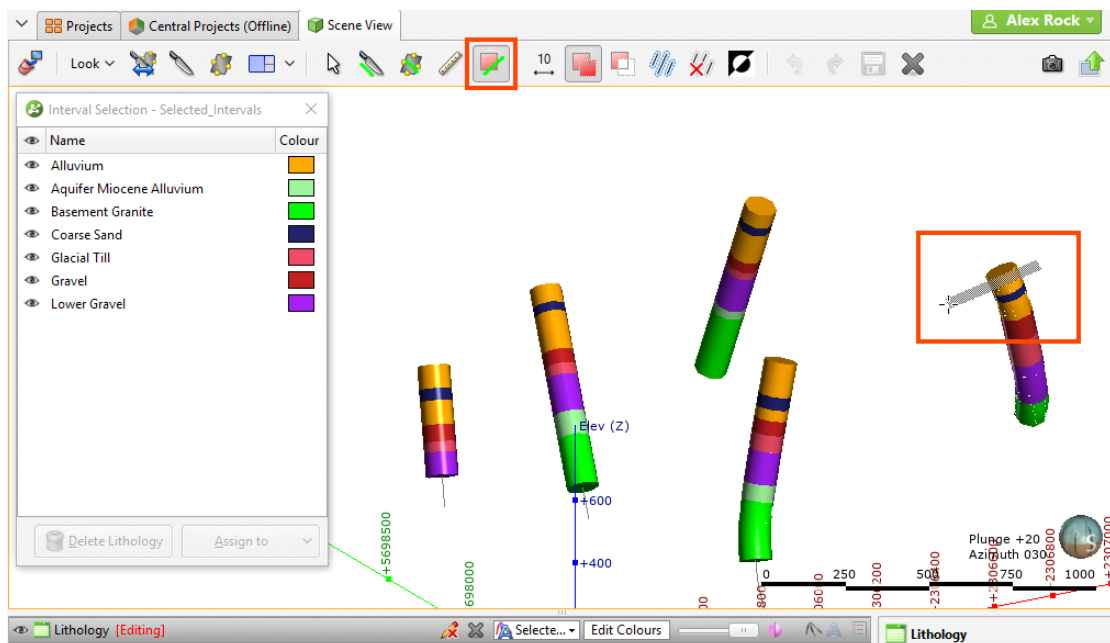

Selected intervals are highlighted in the scene. If you accidentally select the wrong interval, either:

- Click the **Remove Intervals** button (🗑️) and draw across the interval once again.
- Hold the **Ctrl** key while drawing across the interval.

You can also:

- Select all visible intervals by clicking on the **Select All** button (👤) or by pressing Ctrl+A.
- Clear all selected intervals by clicking on the **Clear Selection** button (🗑️) or by pressing Ctrl+Shift+A.
- Swap the selected intervals for the unselected intervals by clicking on the **Invert Selection** button (🔄) or by pressing Ctrl+I.

To change the width of the line used to select intervals, click on the **Change Line Width** button () and enter a new value. You can keep the **Set Line Width** window open while you select intervals so you can change the line width as required.

When you have selected at least one interval, click on the **Assign to** button, then either select an existing lithology or create a new lithology by selecting **Create New Lithology**:

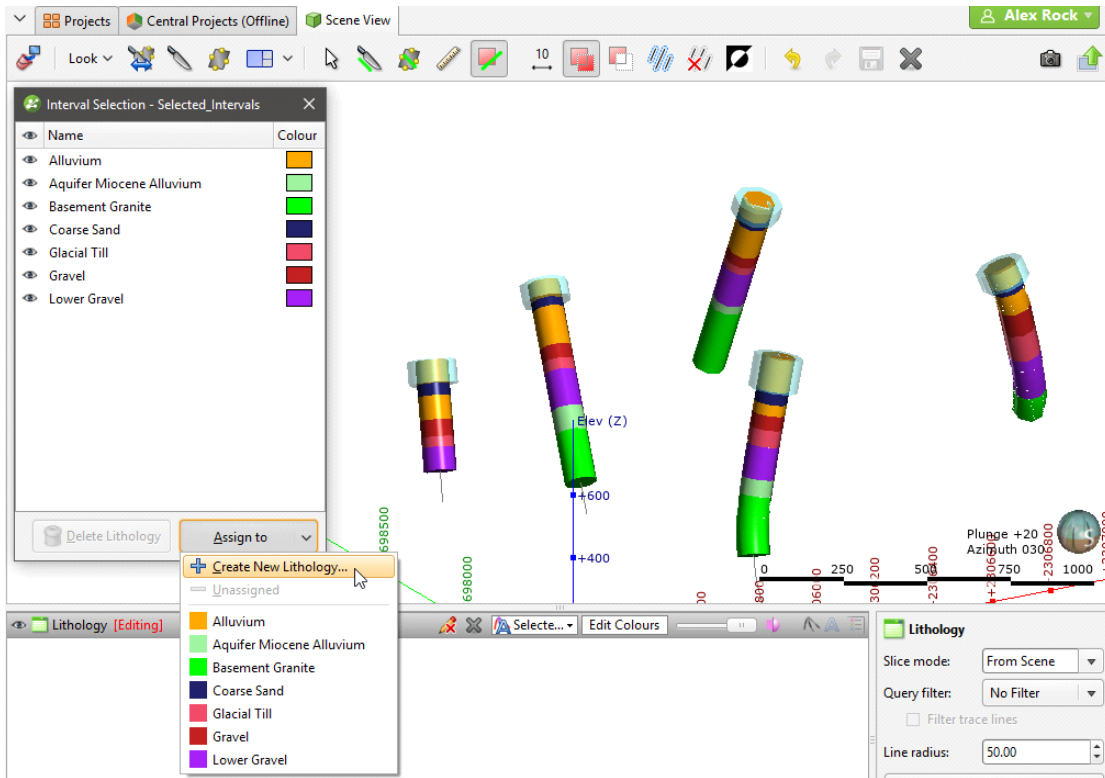

Enter a **Name** for the new lithology, then click **OK**:

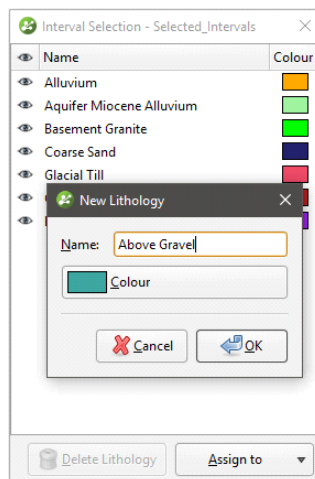

The new lithology will be created and the scene updated to reflect the changes:

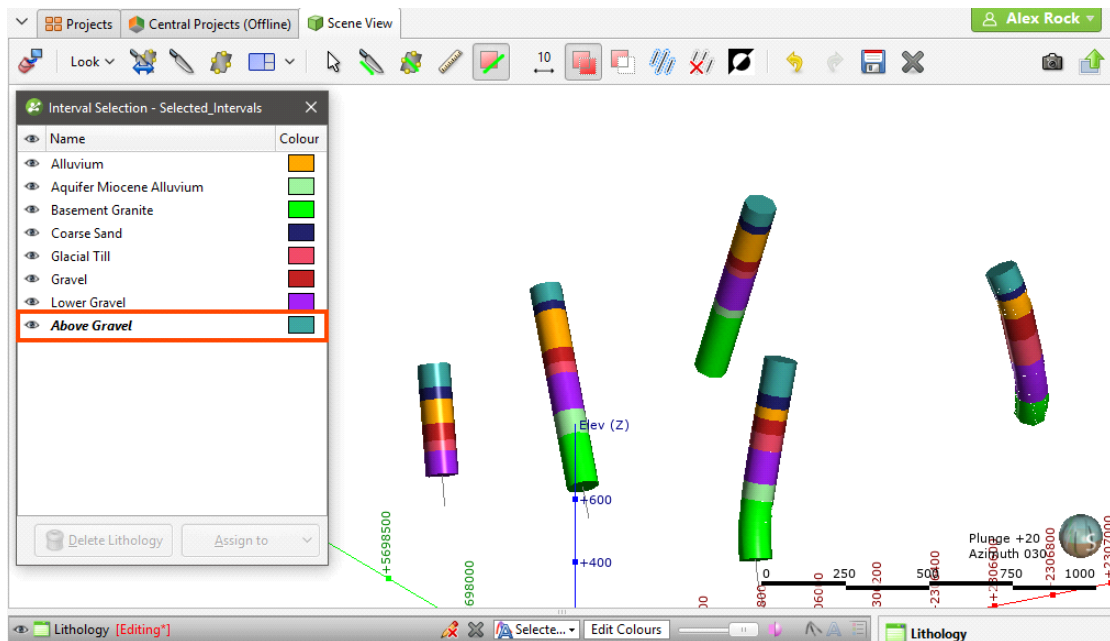

Once you have created a new lithology, you can add to it by selecting intervals, then selecting the lithology from the **Assign to** list.

When you are finished, click the **Save** button (📁) and close the **Interval Selection** window. The new lithology column will appear in the project tree as an additional lithology column in the interval table. Select the new column from the shape list to display it:

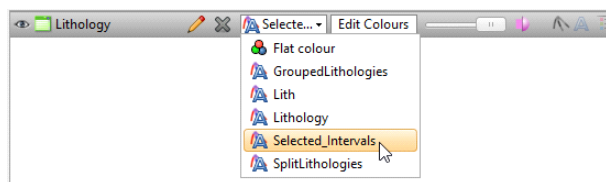

Overlaid Lithology Column

You may have two versions of an interval column, one that contains draft data and one that contains the final version. The final version may contain gaps, which can be filled in using the draft version. The overlaid lithology tool lets you combine the two columns to create a new column.

Both columns must be part of the same interval table. If they are not, use the merged table tool to create a new table that contains both columns. See [Merged Drillhole Data Tables](#).

To create an overlaid lithology column, right-click on the interval table in the project tree and select **New Column > Overlaid Lithology Column**. For a merged table, right-click on it and select **Overlaid Lithology Column**.

The **New Overlaid Lithology Column** window will appear:

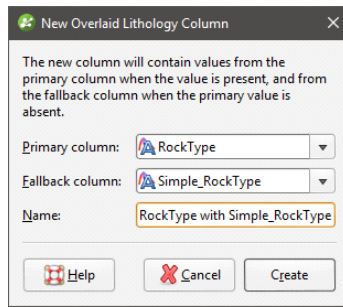

For the **Primary column**, select the column that you wish to have precedence. Data in the **Fallback column** will be used when no data is available from the **Primary column**.

Click **Create** to create the new column. The new column will appear in the project tree.

You can display drillhole data with the new column by selecting it from the shape list:

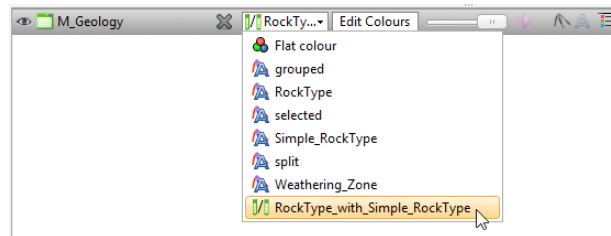

Category Column from Numeric Data

When you have numeric data you wish to use with the lithology and category modelling tools, you can convert the numeric data to a category column. To do this, right-click on the numeric data column and select **New Column > Category From Numeric**. In the window that appears, select the **Base Column**, then enter a name for the new column. Click **OK**.

The next step is to sort the numeric data into categories:

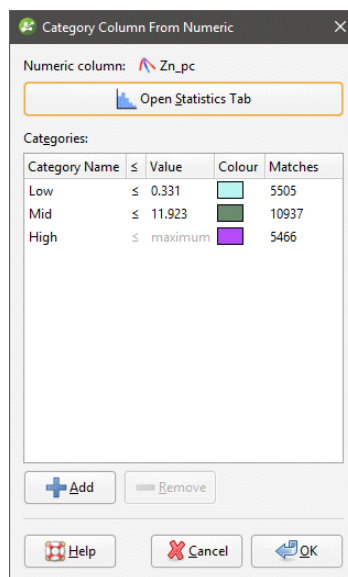

Leapfrog Geo automatically assigns three categories calculated from the distribution of data. To add a new category, click the **Add** button and enter the required value. Click the **Open Statistics Tab** button to view the distribution of data, which will help in deciding what categories to define. See [Univariate Graphs](#) in the [Analysing Data](#) topic for more information on using this tab.

Click **OK** to create the new column, which will appear in the project tree as part of the original interval table.

Back-Flagging Drillhole Data

Evaluating geological models on drillholes creates a new lithology table containing the lithologies from the selected model. This is useful for validating models created from drillhole data as you can generate statistics for the correlation between modelled geology and drilling data.

To create a back-flagged drillhole data table, right-click on the **Drillholes** object in the project tree and select **New Evaluation**. The **New Evaluation** window will appear:

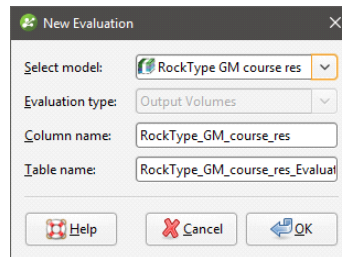

Select the model to use and enter names for the column and table.

When the selected model is a faulted model, the **Evaluation Type** setting determines whether the model's output volumes, faulted output volumes or fault blocks are evaluated.

Click **OK** to create the new table, which will appear in the project tree as part of the **Drillholes** object. The new table contains From, To and Lithology columns defined using the intersection between the model's output volumes and the drillholes.

For output volume evaluations, you can view the correlation between modelled geology and actual logged drillhole segments. To do this, right-click on the table and select **Statistics**. In the **Correlation Statistics** window, you can compare model values to drilled lithologies or vice versa.

See:

- [Comparing Modelled Values to Drilling Lithologies](#)
- [Comparing Drilling Lithologies to Modelled Values](#)
- [Refining the Geological Model to Improve Correlation Statistics](#)

You can export the information displayed in the **Correlation Statistics** window in CSV format for use in other applications. To do this, click **Export**.

Comparing Modelled Values to Drilling Lithologies

Comparing **model values to drilling lithologies** shows how accurately drilling lithologies are modelled in the selected geological model. High matching percentages for drilling lithologies in the left-hand side of the window mean the model closely matches the drilling data for that lithology:

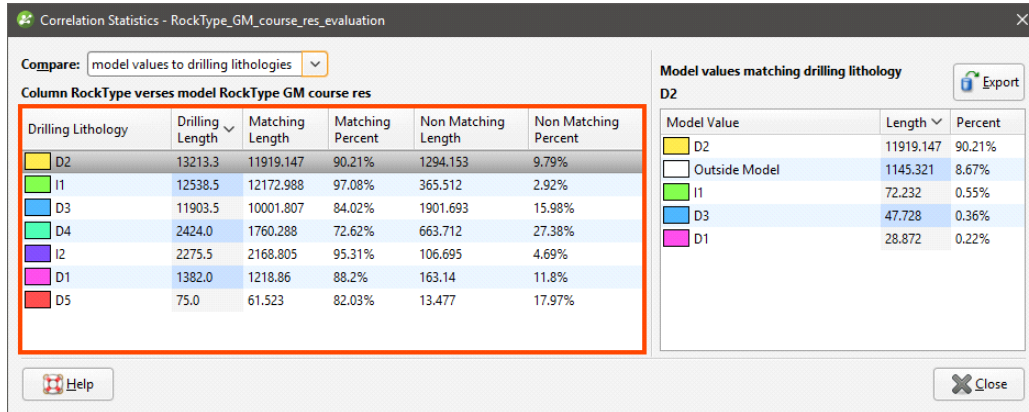

The right-hand side of the window shows the composition of the modelled values for the selected **Drilling Lithology**. Here, D1 in the geological model corresponds to D1 in the lithology data for 88.2% of the length of the drillhole:

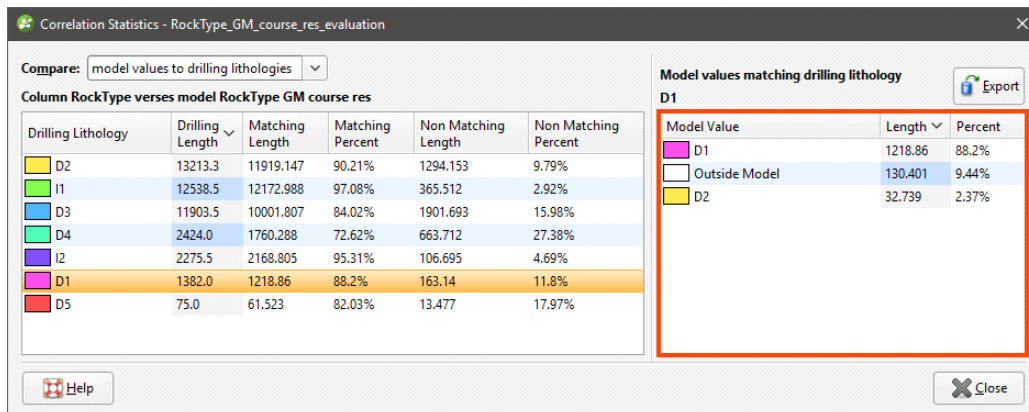

D1 in the model is actually D2 for 2.37% of the length of the drillholes, and 9.44% of the drilled D1 values fall outside of the boundary of the geological model.

In the images that follow, we will look at the correlation between the D5 drilling lithology and modelled D5. Here, two drillhole data tables are displayed with the D5-D4 contact surface from the geological model:

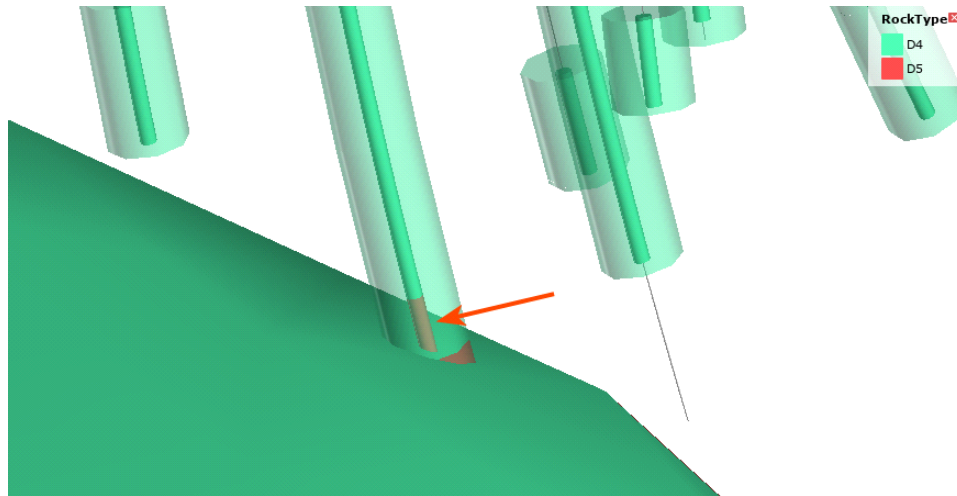

The inner drillholes show the original drillhole data. The outer drillholes show the geological model back-flagged onto the drillhole data table. In the highlighted drillhole, we can see there is a discrepancy between the actual lithology data and that modelled. When we view correlation statistics for this model, we can see that this discrepancy is explained by the fact that 17.97% of the D5 drilling length is modelled as D4:

Correlation Statistics - RockType_GM_course_res_evaluation

Compare: model values to drilling lithologies

Column RockType versus model RockType GM course res

Drilling Lithology	Drilling Length	Matching Length	Matching Percent	Non Matching Length	Non Matching Percent
D2	13213.3	11919.147	90.21%	1294.153	9.79%
I1	12538.5	12172.988	97.08%	365.512	2.92%
D3	11903.5	10001.807	84.02%	1901.693	15.98%
D4	2424.0	1760.288	72.62%	663.712	27.38%
I2	2275.5	2168.805	95.31%	106.695	4.69%
D1	1382.0	1218.86	88.2%	163.14	11.8%
D5	75.0	61.523	82.03%	13.477	17.97%

Model values matching drilling lithology

D5

Model Value	Length	Percent
D5	61.523	82.03%
D4	13.477	17.97%

Help Close

You might consider this an acceptable match, but if it is too low, there are several ways to refine the geological model so that the geological model more closely reflects the original drillholes, which are discussed below. For this example, we will adjust the resolution of the geological model. The modelled segment now corresponds more closely to the original drillhole data:

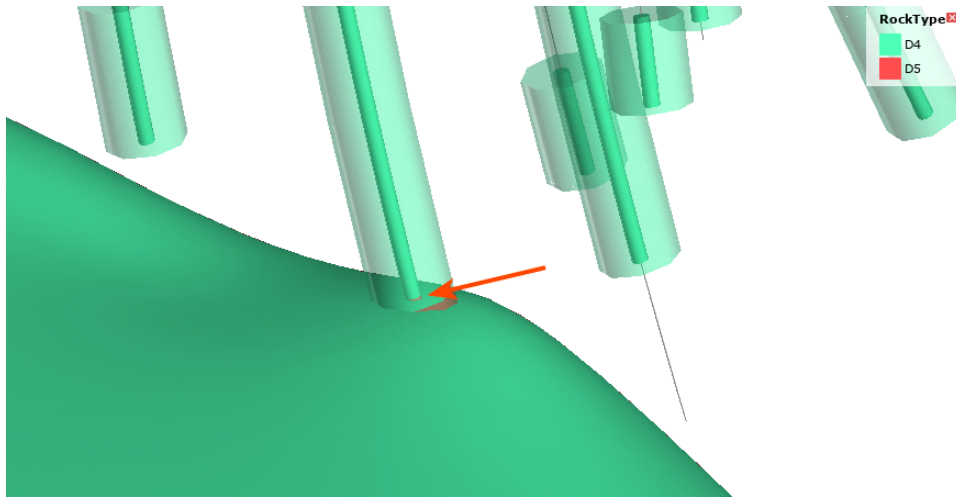

Viewing the correlation statistics shows that 99.62% of modelled drillholes now match the original data:

Correlation Statistics - RockType_GM_course_res_evaluation

Compare: model values to drilling lithologies

Column RockType versus model RockType GM course res

Drilling Lithology	Drilling Length	Matching Length	Matching Percent	Non Matching Length	Non Matching Percent
D2	13213.3	12048.174	91.18%	1165.126	8.82%
I1	12538.5	12310.02	98.18%	228.48	1.82%
D3	11903.5	10108.977	84.92%	1794.523	15.08%
D4	2424.0	1772.028	73.1%	651.972	26.9%
I2	2275.5	2271.957	99.84%	3.543	0.16%
D1	1382.0	1242.729	89.92%	139.271	10.08%
D5	75.0	74.716	99.62%	0.284	0.38%

Model values matching drilling lithology D5

Model Value	Length	Percent
D5	74.716	99.62%
D4	0.284	0.38%

Buttons: Help, Close, Export

Comparing Drilling Lithologies to Modelled Values

Comparing **drilling lithologies to model values** shows the lithological composition of modelled values. Again, high matching percentages in the left-hand side of the window mean the model closely matches the drilling data for that modelled lithology:

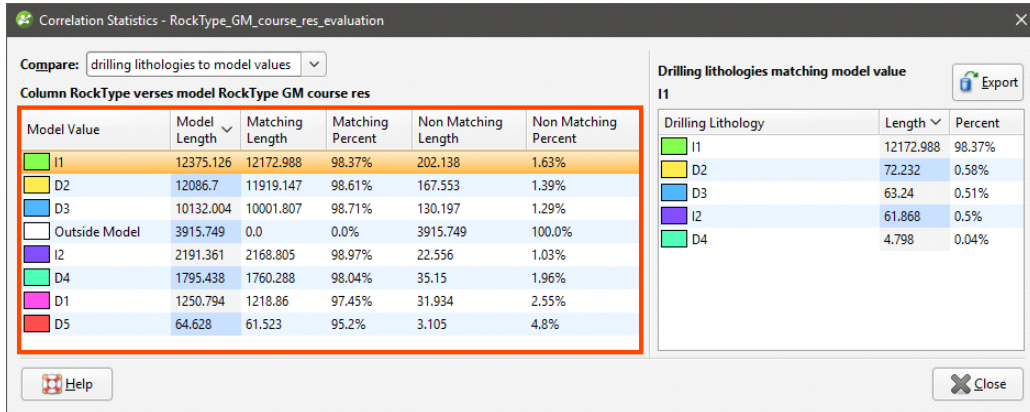

The non-matching percentage indicates how much of the modelled lithology is not the drillhole lithology. You can see in the right-hand side of the window the lithologies that make up the non-matching portions of the modelled value.

In the images that follow, we will look at the correlation between the D5 drilling lithology and modelled D5 once again. The non-matching percentage is 4.8, and on the right-hand side of the window, we can see that this is exclusively drilling lithology I2:

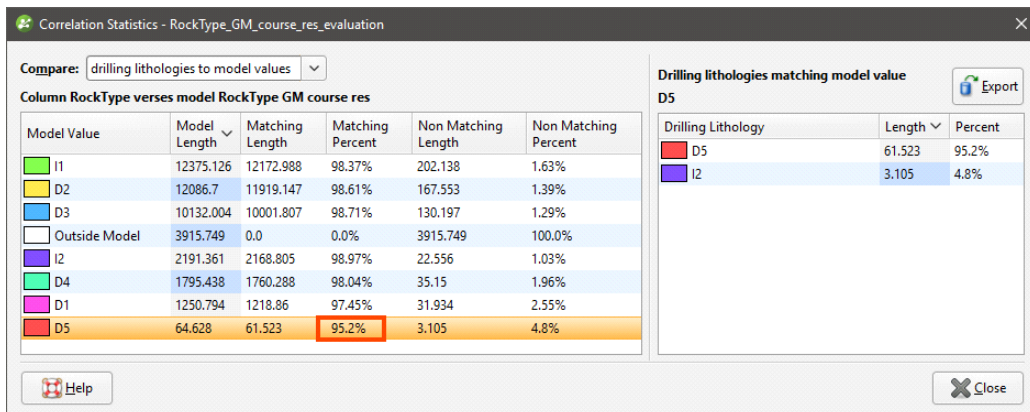

Adjusting the resolution of the geological model improves the matching percentage to the point where only 0.09 percent of the D5 modelled value is drilling lithology I2:

Correlation Statistics - RockType_GM_course_res_evaluation

Compare: drilling lithologies to model values

Column RockType versus model RockType GM course res

Model Value	Model Length	Matching Length	Matching Percent	Non Matching Length	Non Matching Percent
I1	12325.4	12310.02	99.88%	15.38	0.12%
D2	12074.351	12048.174	99.78%	26.177	0.22%
D3	10122.208	10108.977	99.87%	13.231	0.13%
Outside Model	3915.749	0.0	0.0%	3915.749	100.0%
I2	2272.93	2271.957	99.96%	0.973	0.04%
D4	1775.087	1772.028	99.83%	3.059	0.17%
D1	1251.289	1242.729	99.32%	8.56	0.68%
D5	74.786	74.716	99.91%	0.07	0.09%

Drilling lithologies matching model value D5

Drilling Lithology	Length	Percent
D5	74.716	99.91%
I2	0.07	0.09%

Refining the Geological Model to Improve Correlation Statistics

If the matching percentages are too low for the lithologies of interest, there are several ways to refine the geological model so that the geological model more closely matches the drillholes:

- Reduce the resolution of the geological model or of its contact surfaces. See [Surface Resolution for a Geological Model](#) and [Surface Resolution in Leapfrog Geo](#).
- Add more data to the model's surfaces. See [Adding Data to Surfaces](#).
- Snap surfaces to the data used to create them. See [Honouring Surface Contacts](#).

Merged Drillhole Data Tables

When you have more than one drillhole interval table in a project, you can create a new table using selected columns from existing interval tables. You can include columns created by, for example, grouping or splitting lithologies or compositing.

To create a merged table, right-click on the **Drillholes** object in the project tree and select **New Merged Table**. The **New Merged Table** window will appear showing all interval columns available in the project:

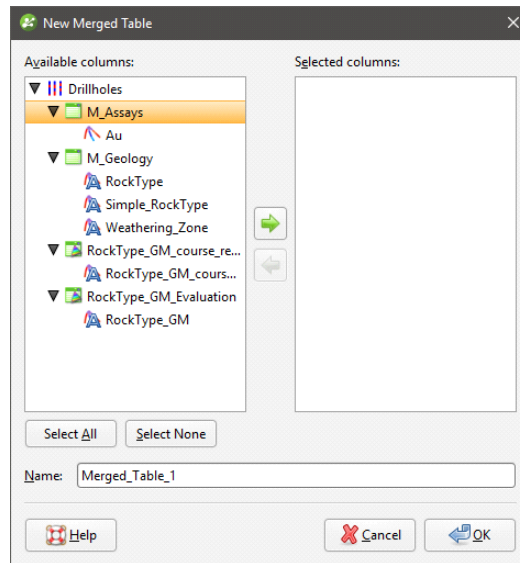

You can change the columns included once you have created the table.

Select the columns you wish to include in the new table and click **OK**. The new table will appear in the project tree as part of the **Drillholes** object.

You can create query filters for a merged data table, as described in the [Query Filters](#) topic. You can also select intervals (see [Interval Selection](#)) and create an overlaid lithology column (see [Overlaid Lithology Column](#)). You cannot, however, use the group lithologies and split lithology tools on a merged table.

To edit the table, right-click on it and select **Edit Merged Table**.

Core Photo Links

Leapfrog Geo can link drillhole data to ALS Webtrieve and Coreshed core photo databases. When drillhole data has been linked, a photo link object will appear in the project tree:

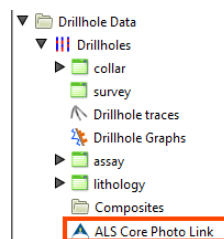

You can only have one type of core photo link associated with the drillhole data. To add a link, right-click on the **Drillholes** object and select **Add Core Photo Link**. In the window that appears, select the core photo provider and click **OK**:

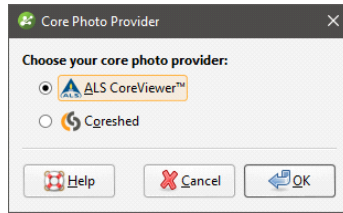

An alternative to linking to a core photo database is to link to files stored locally or on a network drive. This can be achieved by having a URL column in an interval table. When the interval is selected in the scene, you can click the link to view the file:

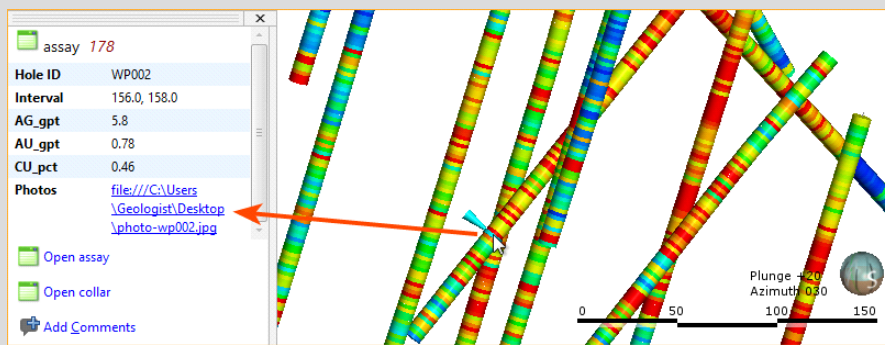

Use the prefix file:/// to link to local files.

For information on setting up ALS Webtrieve and Coreshed links, see:

- [Setting Up the ALS Interface](#)
- [Setting Up the Coreshed Interface](#)

To use the core photo links, see:

- [Using the ALS Interface](#)
- [Using the Coreshed Interface](#)

The ALS Core Photo Interface

This topic describes how to set up and use the ALS core photo interface. It is divided into:

- [Setting Up the ALS Interface](#)
- [Using the ALS Interface](#)
- [Removing the ALS Link](#)

Setting Up the ALS Interface

Before you can view core photos, you must first log in to the ALS database. Two levels of security are provided, one set up in Leapfrog Geo and the next via your browser.

To set up the interface between Leapfrog Geo and the ALS database, right-click on the **Drillholes** object and select **Add Core Photo Link**. In the window that appears, select **ALS Webtrieve** and click **OK**. The **ALS Core Photo Settings** window will appear. Information required to access core data is the **Project Name** and the **Encryption Key**. This information provides the first level of security for information in the ALS database. Click on each field and enter the required information. The information is case-sensitive, so ensure that the characters entered are correctly capitalised.

For **Leapfrog depths measured in**, ensure that the units used for depth match in Leapfrog Geo and ALS.

For **Open selection in new browser**, choose whether each core photo will be opened in a separate browser **Window** or **Tab**.

Click **OK** to save the information. If login is successful, the **ALS Core Photos** button (📷) will appear in the toolbar:

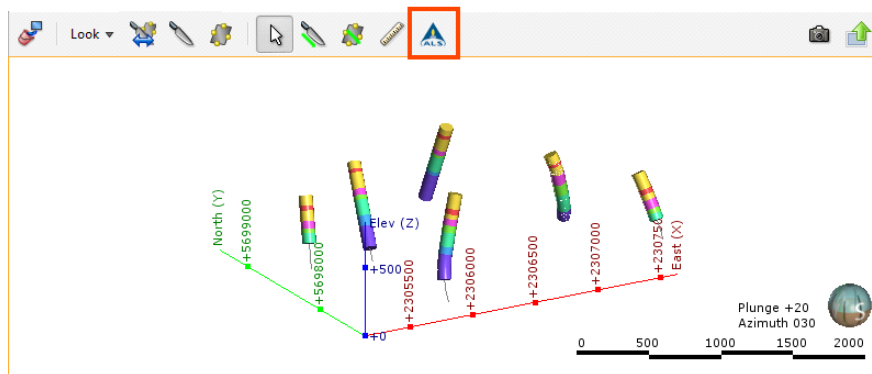

A link will also appear in the project tree as part of the **Drillholes** object:

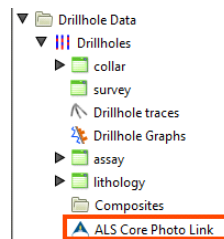

You can edit the link by double-clicking on it.

Using the ALS Interface

To view core photos, click on a drillhole in the scene, then click on the **ALS Core Photo Link** button in the window that appears:

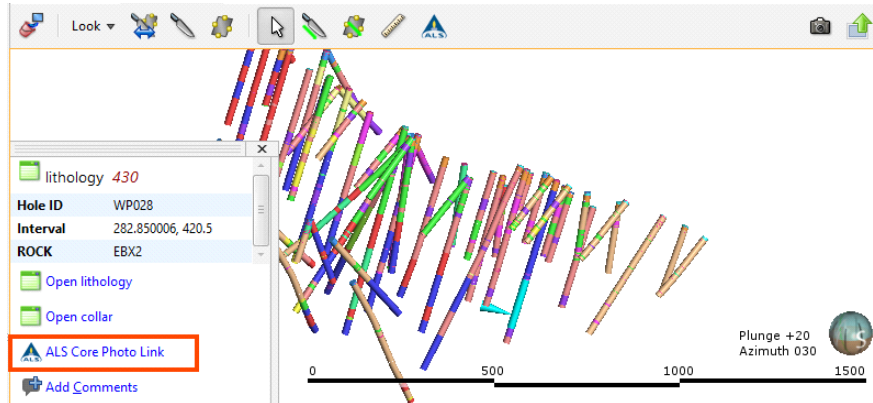

Your browser will be launched and you will be prompted to log in to the ALS database. Enter the **User Name** and **Password**, which are case-sensitive. Remember to allow the browser to save the details so that you will not be prompted to log in each time you wish to view a photo.

Your browser settings may require that you install a plugin or make changes to settings in order to view core photos. If you are not able to access the ALS database from Leapfrog Geo and have ensured your **Project Name**, **Encryption Key**, **User Name** and **Password** have been entered correctly, contact Customer Support as described in [Getting Support](#).

If you want to view core photos in rapid succession, click on the **ALS Core Photos** button (📷) in the toolbar, then click on a drillhole in the scene. This will simultaneously:

- Display information on the segment selected in Leapfrog Geo
- Display the core photo in your browser

Removing the ALS Link

To remove an ALS link, right-click on it in the project tree and select **Delete**.

The Coreshed Core Photo Interface

This topic describes how to set up and use the Coreshed core photo interface. It is divided into:

- [Setting Up the Coreshed Interface](#)
- [Using the Coreshed Interface](#)
- [Removing the Coreshed Link](#)

Setting Up the Coreshed Interface

Before you can view core photos, you must first set up the Coreshed interface. To do this, right-click on the **Drillholes** object and select **Add Core Photo Link**. In the window that appears, select **Coreshed** and click **OK**. The **Coreshed Photo Settings** window will appear. Select whether each core photo will be opened in a separate browser **Window** or **Tab**.

Click **OK** to save the information. The **Coreshed Core Photos** button (🔄) will appear in the toolbar:

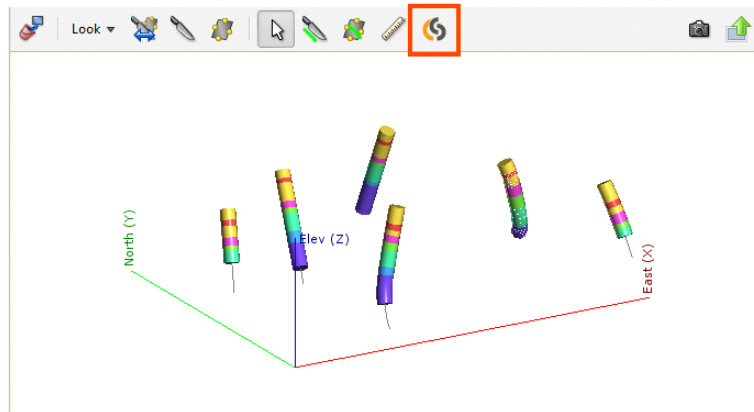

A link will also appear in the project tree as part of the **Drillholes** object:

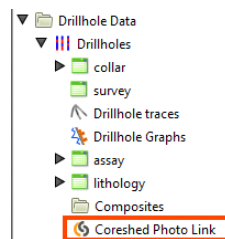

You can edit the link by double-clicking on it.

Using the Coreshed Interface

To view core photos, click on a drillhole in the scene, then click on the **Coreshed Photo Link** button in the window that appears:

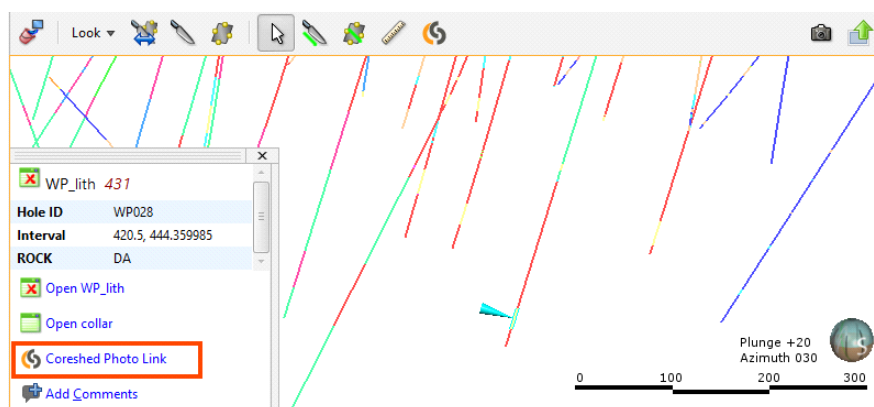

Your browser will be launched and you will be prompted to log in to the Coreshed database. Enter the **Username** and **Password**, which are case-sensitive. Remember to allow the browser to save the details so that you will not be prompted to log in each time you wish to view a photo.

Your browser settings may require that you install a plugin or make changes to settings in order to view core photos. If you are not able to access the Coreshed database from Leapfrog Geo and have ensured your **Username** and **Password** have been entered correctly, contact Customer Support as described in [Getting Support](#).

If you want to view core photos in rapid succession, click on the **Coreshed Photo Link** button () in the toolbar, then click on a drillhole in the scene. This will simultaneously:

- Display information on the segment selected in Leapfrog Geo
- Display the core photo in your browser

Removing the Coreshed Link

To remove a Coreshed link, right-click on it in the project tree and select **Delete**.

Reloading Drillhole Data

Reloading data is necessary when the imported data is modified externally. All drillhole data can be reloaded by right-clicking on the **Drillholes** object and selecting **Reload Drillholes**. If you only need to reload a single table, right-click on that table and select **Reload Data**.

Reloading drillhole data overwrites all existing drillhole data. If you have data you wish to add to the project without overwriting existing data, use the **Append Drillholes** option.

The process is similar to that for importing drillhole data:

- If the drillhole data was loaded from a file on your computer or a network location, you will be prompted to specify the file locations.
- If the interval table is stored in an ODBC database, you will be prompted to connect to the database. See [Selecting the ODBC Data Source](#).
- If your drillhole data is stored in an acQuire database, you will be prompted to connect to the database. See [Connecting to an acQuire Database](#).

When you reload data, Leapfrog Geo retains the table structure and refreshes the data contained in the tables. This ensures that you do not need to reassign the data type for each column and select the columns to be imported.

Exporting Drillhole Data

Changes made to the drillhole data in Leapfrog Geo only affect the Leapfrog Geo database, not the original data files. You can export Leapfrog Geo drillhole data, which is useful if you wish to keep a copy of drillhole data outside the project.

You can:

- Export all data. See [Exporting All Drillhole Data](#).
- Export only a single data table. See [Exporting a Single Drillhole Data Table](#).

These export options export the drillhole data tables using To and From values to indicate location information. If you wish to export data with X-Y-Z values, extract points data using one of the following options:

- [Extracting Contact Points from Drillhole Data](#)
- [Extracting Intrusion Values from Drillhole Data](#)
- [Extracting Interval Midpoints from Drillhole Data](#)

Then export the data object as described in [Exporting Points Data](#).

Exporting All Drillhole Data

To export all drillhole data, right-click on the **Drillholes** object and select **Export**. The **Export Drillhole Data** window will appear:

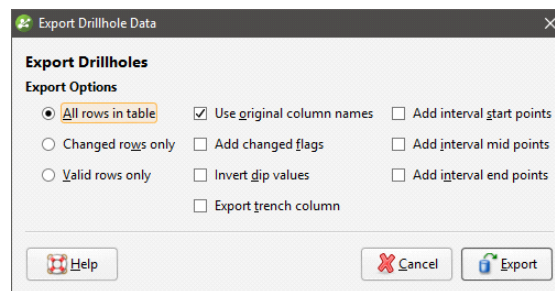

Once you have selected how you wish to export the data, click **OK**. The **Export Drillhole Data Files** window will appear:

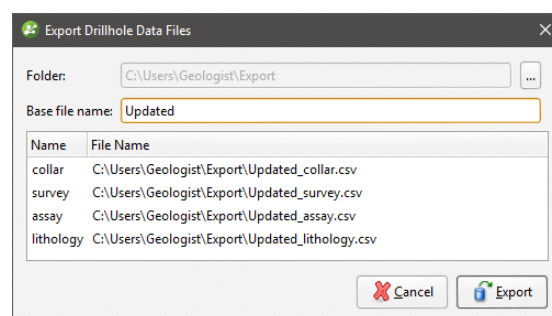

The list shows the files that will be created, one for each data table. Choose the **Folder** where the files will be saved, then enter a **Base file name**, which will be added to the front of each file name.

Click **Export** to save the files.

Exporting a Single Drillhole Data Table

To export a single drillhole data table, right-click on that table and select **Export**. The **Export Drillhole Data** window will appear:



Once you have selected how you wish to export the data, click **OK**. You will be prompted for a filename and location.

Points Data

Points are sets of X-Y-Z coordinates, with or without associated values. In Leapfrog Geo, points are used to define surfaces and for interpolation. You can use the **Points** folder to:

- Import points data
- Extract contact points, intrusion values and interval midpoints from drillhole data
- Create guide points
- Create grids of points that can be evaluated against geological and numeric models and exported for use in other modelling

The rest of this topic describes importing and exporting points, setting elevation for points and evaluating points. It is divided into:

- [Importing Points Data](#)
- [Reloading Points Data](#)
- [Appending Points Data](#)
- [Importing a Column](#)
- [Importing ASEG_DFN Points](#)
- [Setting Elevation for Points](#)
- [Evaluating Points Data](#)
- [Displaying Points](#)
- [Viewing Points Table Statistics](#)
- [Exporting Points Data](#)

Importing Points Data

Leapfrog Geo supports the following file types for points data:

- CSV files (*.csv)
- ASCII text files (*.asc)
- DXF files (*.dxf)
- Leapfrog Geo 3D Point Data files (*.pl3, *.ara)

Points data can be imported from:

- Files stored on your computer or a network location. Right-click on the **Points** folder and select **Import Points**. You will be prompted to select a file.
- From any database that runs an ODBC interface. Right-click on the **Points** folder and select **Import Points via ODBC**. See [Selecting the ODBC Data Source](#) below.

For each of these options, once the data source is selected, the process of importing the data is the same.

When importing a file that has multiple features, you will be prompted to select which ones to import. You can also choose to:

- Import the features as separate objects. Each feature will appear in the project tree as a separate object.
- Flatten all features into one object. Leapfrog Geo will treat all features as a single object.

Once imported, the file will be added to the **Points** folder. If there are errors in the data, the errors can be corrected as described in [Correcting Data Errors in Leapfrog Geo](#).

To view the imported data, double-click on the object that has been added to the **Points** folder.

Once points data has been imported to the project, it can be modified and evaluated against geological models, numeric models and estimators, as described in [Evaluating Points Data](#).

Selecting the ODBC Data Source

When importing points data from an ODBC database, you will need to specify the ODBC data source. Enter the information supplied by your database administrator and click **OK**.

Once the data source is selected, the import process is similar to that described above.

Reloading Points Data

Reloading data is necessary when the imported data is modified externally. Points data can be reloaded by right-clicking on the table and selecting **Reload Data**.

Reloading points data overwrites all data in the existing table. If you have data you wish to add to the project without overwriting existing data, use the **Append Data** option.

The process is similar to that for importing the original table.

Appending Points Data

If points data is stored in multiple files, you can import these files into the project and add them to existing points data. To do this, right-click on the object you wish to append and select **Append Data**. You will be prompted to select a file.

Next, the **Import Tables For Appending** window will be displayed.

Check the data to ensure that the correct information will be imported, then click **Finish** to add the new file.

Importing a Column

Columns of points data that were not imported when the original data was imported or that are stored in a separate file can be added to the table at any time. To do this, right-click on the points table in the project tree and select **Import Column**.

The process is similar to importing the original table; select the file and map the columns you wish to import.

Importing ASEG_DFN Points

Leapfrog Geo imports ASEG_DFN points in *.dfn format. To import an ASEG_DFN file, right-click on the **Points** folder and select **Import ASEG_DFN**. Leapfrog Geo will ask you to specify the file location. Click **Open** to import the file. In the window that appears, enter a name for the file, then click **OK**. Next set the X, Y and Z coordinates and click **OK**. If you select no column for the Z coordinates, all Z values will be set to zero.

The file will appear in the **Points** folder.

Setting Elevation for Points

You can set the elevation for points tables by projecting them onto a surface. This overwrites elevation values in the z column of the points table, using the data from the selected surface. If the surface does not intersect vertically with all points, you can choose how the z values for those unprojected points will be handled.

To set the elevation for points from a surface, right-click on the points object in the project tree and select **Set Elevation**. The **Set Elevation** window will appear:

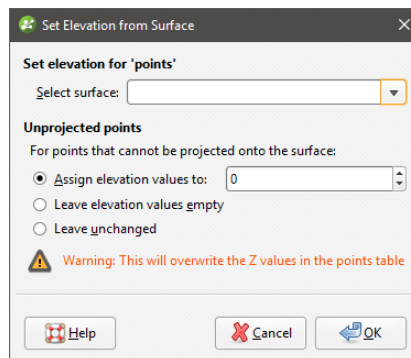

Select from the surfaces available in the project.

Next, select how unprojected points should be handled. There are three options:

- **Assign elevation values to** sets the z values to a fixed elevation for all unprojected points.
- **Leave elevation values empty** clears the z values for all unprojected points.
- **Leave unchanged** makes no changes to the z values for unprojected points.

Click **OK** to set elevation values.

Evaluating Points Data

Once points data has been imported to the project, it can be modified and evaluated against geological models, numeric models and estimators, as described in [Evaluations](#).

In the case of geological models, you can also combine two or more models to evaluate the points data and set the priority used for evaluation. To do this, click on the **Combined**

Evaluation button in the **Select Models To Evaluate** window. In the window that appears, select the evaluations to combined, then set their priority. Click **OK** to create the combined evaluation, then click **OK** in the **Select Models To Evaluate** window. The combined evaluation will be available from the colour list.

To delete a combined evaluation, click on the **Delete Combined** button in the **Select Models To Evaluate** window.

Displaying Points

Points data can be displayed using a single flat colour, using a colour gradient or using the points values. You can also import a colourmap, which is described in [Colour Options](#).

As with drillholes, points data can be displayed as flat points or as spheres. When **Make points solid** button (🔴) is enabled for points data, the data points are displayed as spheres. Here, the values are displayed as flat points:

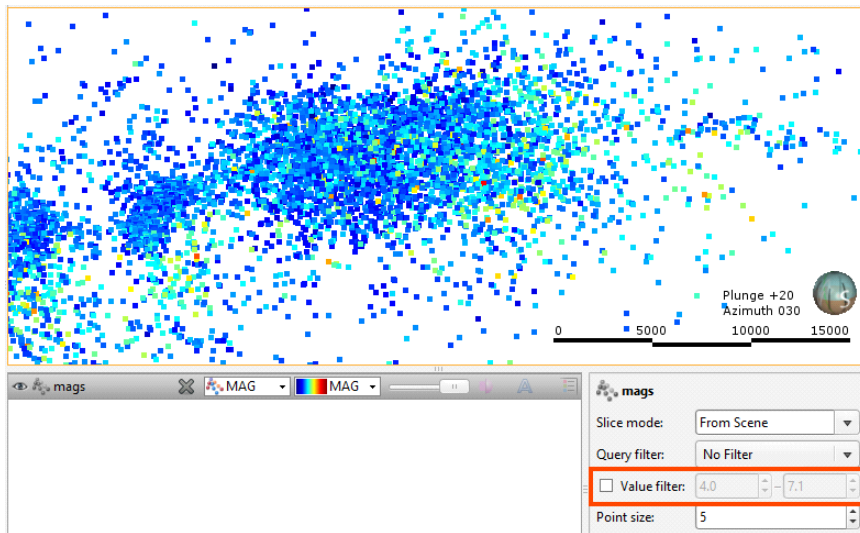

You can restrict the range of values displayed using the **Value filter** in the properties panel.

When using the spheres option (🔴), the points can be displayed using the values. To do this, the **Radius values** list displays the columns available:

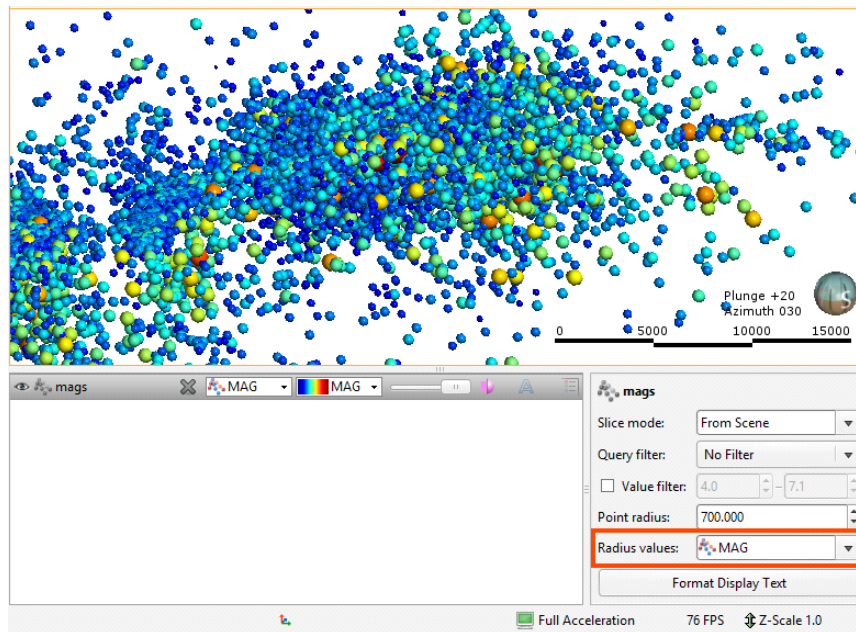

Select the column that will be used to determine the point size.

The **Point radius** control then determines the maximum point size displayed in the scene.

Viewing Points Table Statistics

To view statistics on points data tables, right-click on a points table and select **Statistics**. The following options are available:

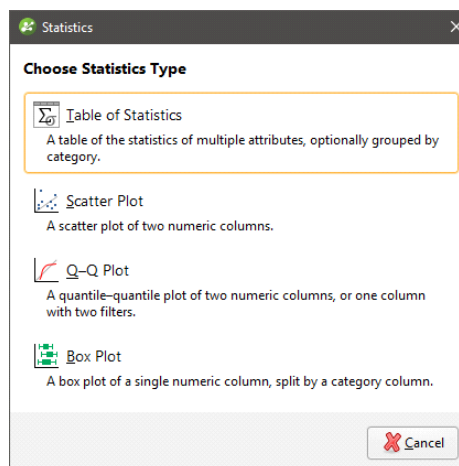

See the [Analysing Data](#) topic for more information on each option:

- [Table of Statistics](#)
- [Scatter Plots](#)
- [Q-Q Plots](#)
- [Box Plots](#)

Exporting Points Data

To export points data, right-click on the points data object in the project tree and select **Export**. For many points objects, you will be prompted to select which rows to include. Points data can be exported in the following formats:

- CSV Files (*.csv)
- DXF Files (11/12 [AC1009]) (*.dxf)
- Drawing Files (2013/LT2013) (*.dwg)
- Bentley Drawing Files (v8) (*.dgn)

Additional export options are available for some types of points, which are described below.

Once you have selected how you wish to export the data, click **Export**. You will be prompted for a filename and location.

Exporting Intrusion Values

Intrusion values can be extracted from drillhole data as described in [Extracting Intrusion Values from Drillhole Data](#).

There are two options for exporting intrusion values:

- Export only the contact points. To do this, right-click on the intrusion values object and select **Export**. If you choose this option, you can export the points in CSV format (*.csv), DXF format (*.dxf) or DWG format (*.dwg).
- Export all the points used in creating an intrusion. To do this, right-click on the intrusion values object and select **Export Volume Points**. If you choose this option, you can only export the points in CSV format (*.csv).

In both cases, you will be prompted for a filename and location.

Exporting Interval Midpoints

Interval midpoints can be extracted from drillhole data, which is described in [Extracting Interval Midpoints from Drillhole Data](#). You can also export midpoints directly from an RBF interpolant, which is described in [Exporting Numeric Model Midpoints](#).

To export interval midpoints, right-click on the points data object in the project tree and select **Export**. Interval midpoints can be exported in the following formats:

- CSV text file (*.csv)
- Snowden Supervisor CSV file (*.csv)
- Isatis 3D points file (*.asc)

The values exported are the midpoints of each segment, the X-Y-Z values and the hole ID. The Snowden Supervisor and Isatis 3D points formats also include the interval length.

In each case, you will be prompted for a filename and location.

Extracting Points from Drillhole Data

This topic describes extracting different types of points from imported drillhole data. It is divided into:

- [Extracting Contact Points from Drillhole Data](#)
- [Extracting Intrusion Values from Drillhole Data](#)
- [Extracting Interval Midpoints from Drillhole Data](#)

If you wish to save and export points data with X-Y-Z information, use these options, then right-click on the data object to export the data as described in [Exporting Points Data](#).

Extracting Contact Points from Drillhole Data

Contact points define the boundary between two lithology layers. You can extract contact points from interval tables to create a new points object in the **Points** folder. The values extracted are the x-y-z values of the contact points.

To extract contact points from an interval table, right-click on the **Points** folder and select **New Contact Points**. A window will appear listing the lithology and category columns available in the project:

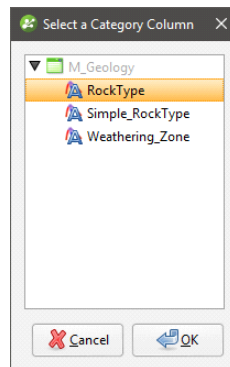

Select the required column and click **OK**.

Next, the **New Contact Points** window will appear:

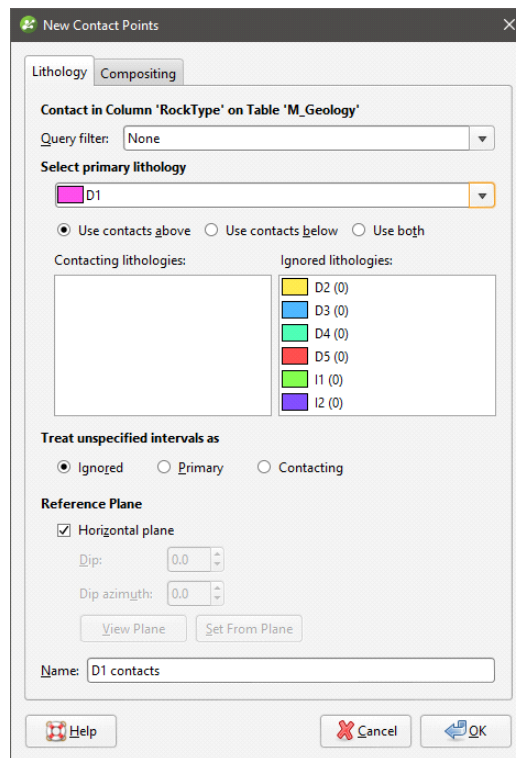

Select the lithology required from the **Select primary lithology** list, then select the adjacent lithologies you wish to extract in the **Contacting lithologies** list.

Unspecified intervals are intervals that have no data. By default, unspecified intervals are ignored when creating new contact points, but you can also treat them as the primary lithology or as contacting lithologies.

For complex geologies, the up and down directions for the surface may not be clear. If this is the case, untick the **Horizontal Plane** box. A reference plane will appear in the scene, with the up-facing surface labelled A and the downward-facing surface labelled B:

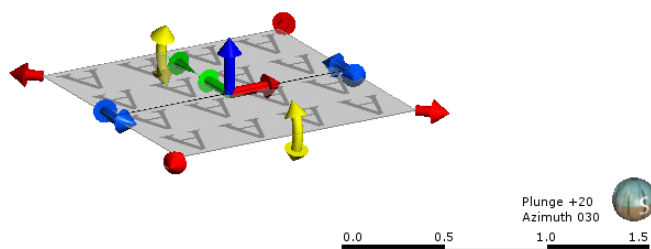

Controlling the position of the reference plane is similar to controlling the position of the moving plane:

- Use the handles in the scene window to move the plane.
- Set the **Dip** and **Dip Azimuth** values in the **New Contact Points** window. The reference plane will be updated in the scene.

Once the reference plane is correctly oriented, click the **Set From Plane** button.

A reference plane set for contact points in the **Points** folder will be applied wherever the contact points are used.

Click **OK** to create the points, which will appear in the project tree under the **Points** folder. To edit the points, double-click on them.

Extracted contact points can be exported as described in [Exporting Points Data](#).

Extracting Intrusion Values from Drillhole Data

You can extract intrusion points from interval tables to create a new points object in the **Points** folder.

To extract intrusion values from an interval table, right-click on the **Points** folder and select **New Intrusion Values**. A window will appear listing the lithology and category columns available in the project:

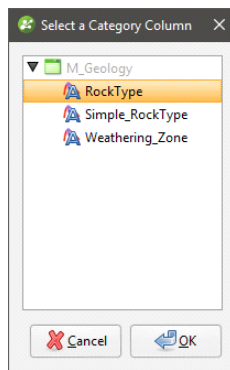

Select the required column and click **OK**.

Next, the **New Intrusion** window will appear:

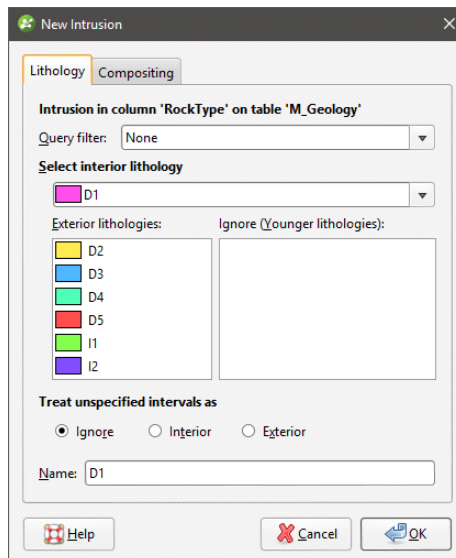

Select the intrusion lithology, then move any younger lithologies to the **Ignore** list.

Unspecified intervals are intervals that have no data. By default, unspecified intervals are ignored when extracting intrusion values, but you can also treat them as the interior lithology or as exterior lithologies.

The settings in the **Compositing** tab are described in [Category Composites](#).

Click **OK** to create the new points object, which will appear in the project tree under the **Points** folder. To edit the points, double-click on the points object (🌐) in the project tree. See [Intrusion Point Generation Parameters](#) below.

When you view the intrusion points in the scene, you can display only the contact points or all the points used determining the extrusion values. To display all points, click on the points object in the shape list and tick the box for **Show volume points**:

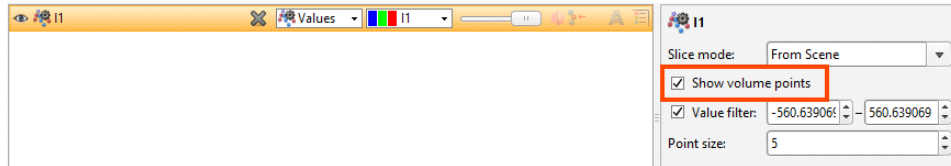

Extracted intrusion points and values can be exported as described in [Exporting Points Data](#).

Intrusion Point Generation Parameters

To change the way intrusion values are generated, double-click on the points object (🌐) in the project tree:

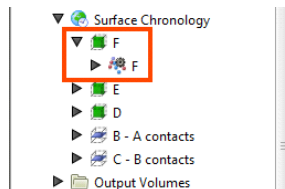

The **Edit Intrusion** window will appear, displaying the **Point Generation** tab.

Here, the surface and volume points are displayed to show the effects of the **Surface offset distance** and **Background fill spacing** parameters:

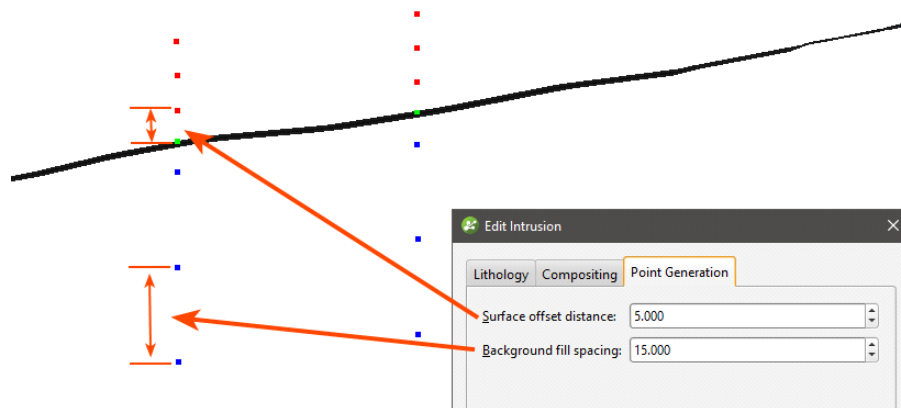

The **Surface offset distance** parameter sets the top and bottom ends of the interval and affects how a surface behaves when it approaches a contact point. A smaller distance restricts the angles that an approaching surface can take. Another factor that affects the angles a surface will take is whether or not a trend has been applied to the surface.

The **Background Fill Spacing** parameter determines the approximate length of segments in the remaining intervals. If the remaining interval is not a multiple of the **Background Fill Spacing** value, Leapfrog Geo will automatically adjust the spacing to an appropriate value. A smaller value for **Background Fill Spacing** means higher resolution and, therefore, slightly smoother surfaces. However, computation can take longer.

Extracting Interval Midpoints from Drillhole Data

You can extract interval midpoints from raw or composited numeric and category tables to create a new points object in the **Points** folder. The extracted points will be dynamically linked to the original drillhole segments and can be evaluated against other data in the project. The values extracted are the midpoints of each segment, the X-Y-Z values and the hole ID.

If you are exporting points data for use in Snowden Supervisor, use this option for extracting points from drillhole data. If you wish to export midpoints from an interpolant, see [Exporting Numeric Model Midpoints](#).

To extract midpoints from an interval table, right-click on the **Points** folder and select **New Interval Mid Points**. In the window that appears, select the required **Source table**, then select which data columns to use:

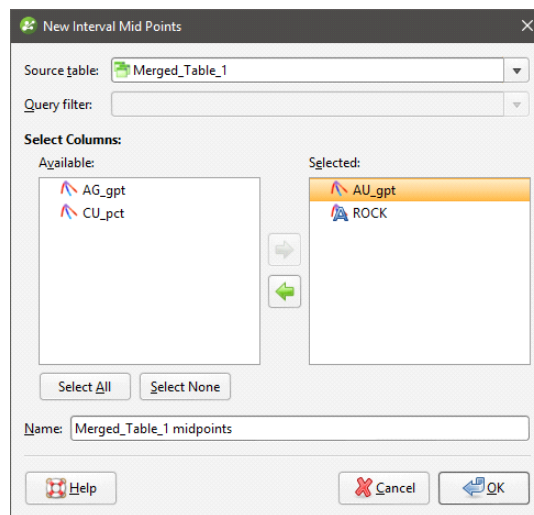

Apply a query filter, if required, then click **OK**. The new points object will appear in the project tree under the **Points** folder. To edit the points, double-click on the points object (🔗) in the project tree.

Changes made to the source data table, such as changes to compositing parameters or special values rules, will be reflected in the extracted points object.

Extracted interval midpoints can be exported as described in [Exporting Points Data](#).

Creating Guide Points

Guide points can be created from any category point data in the project and added to surfaces. Category data that can be used to create guide points includes:

- Downhole category point data
- LAS points
- Category data on imported points
- Interval midpoints

Guide points are classified into interior or exterior, and each guide point is assigned a distance value that is the distance to the nearest point on the opposite side. Interior values are positive and exterior values are negative.

Guide points are a good way of using blasthole data to control surfaces: create the guide points from the downhole points, then add the guide points to the surface.

To create guide points, right-click on the **Points** folder and select **New Guide Points**. A window will appear listing the category columns available in the project:

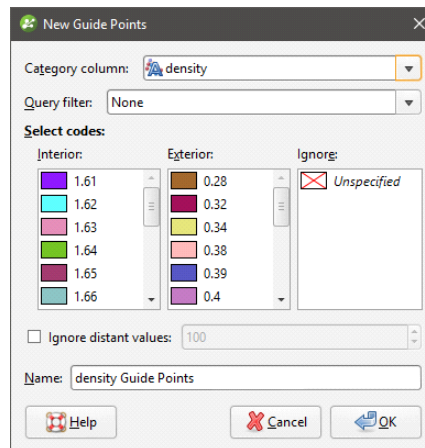

Select the categories to assign to **Interior** (the positive side) and **Exterior** (the negative side).

You can also filter out distant values by ticking the **Ignore distant values** box and entering a value. Often distant values have little effect on a surface and filtering out these values can improve processing time.

Click **OK**. The guide points will appear in the project tree under the **Points** folder. To edit the points, double-click on them.

Guide points can be exported as described in [Exporting Points Data](#).

Grids of Points

You can create a grid of points that can be evaluated against geological and numeric models and exported for use in other modelling packages. This topic describes creating and working with grids of points. It is divided into:

- [Creating a Grid of Points](#)
- [Evaluating a Grid of Points](#)
- [Statistics for a Grid of Points](#)
- [Exporting a Grid of Points](#)

Creating a Grid of Points

You can create a grid of points that can be evaluated against geological models and interpolants and exported for use in other modelling packages.

To create a grid of points, right-click on the **Points** folder and select **New Grid of Points**. The **New Grid of Points** window will appear, together with controls in the scene that will help in setting the grid's boundary:

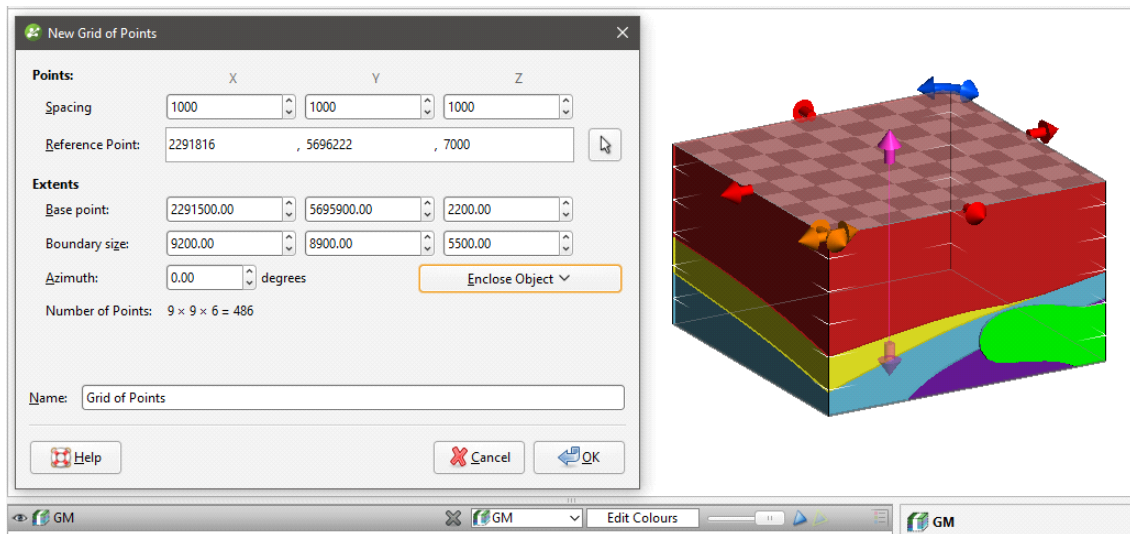

Set the **Spacing** and **Reference Point**, which will control the number of points in the grid. You can set the **Reference Point** by clicking in the scene. To do this, first click on the **Select** button () for the **Reference Point**, then click in the scene. The coordinates in the scene will be copied to the **New Grid of Points** window.

For the **Extents**, you can select an object from the **Enclose Object** list to use the extents of another object in setting the grid's extents. You can also change the size and position of the grid using the controls in the scene:

- The orange handle adjusts the **Base Point**.
- The red and pink handles adjust the **Boundary Size**.
- The blue handles adjust the **Azimuth**.

If you have set the extents from another object and then rotated the grid, you will need to reset the extents by selecting the object again from the **Enclose Object** list.

The **Number of Points** in the grid will be updated as you change settings in the **New Grid of Points** window. If the number of points will be very large, rendering of the grid in the scene will be disabled.

You will be able to change the settings in this window once the grid has been created.

Click **OK** to create the grid, which will appear in the **Points** folder. Double-click on the grid to change its settings.

Evaluating a Grid of Points

Once you have created the grid, you will be able to evaluate it against geological models, interpolants and distance functions in the project. Right-click on the grid and select **Evaluations**, then select from the models available. The evaluations will be shown in the project tree as part of the grid:

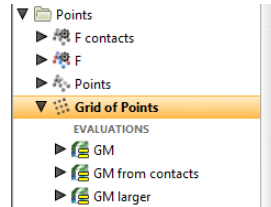

Evaluations will be exported with the grid. See [Exporting a Grid of Points](#) below.

Statistics for a Grid of Points

To view statistics on a grid of points, right-click on the grid and select **Statistics**.

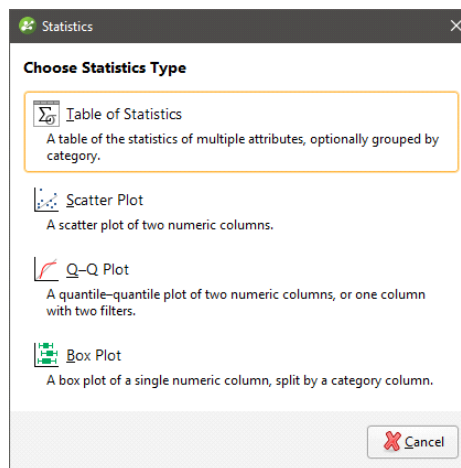

See the [Analysing Data](#) topic for more information on each option:

- [Table of Statistics](#)
- [Scatter Plots](#)
- [Q-Q Plots](#)
- [Box Plots](#)

Exporting a Grid of Points

You can export a grid of points in the following formats:

- CSV file (*.csv)
- GSLIB Data file (*.dat)

- Surpac Block Model file (*.mdl)
- Isatis Block Model file (*.asc)
- Geo 3D Point Data file (*.pl3, *.ara)

For CSV, Surpac Block Model and Isatis format files, all evaluations on the grid of points will be exported as part of the file. For all other file types, only numeric evaluations will be exported.

To export a grid of points, right-click on it in the project tree and select **Export**. Select the format required, enter a filename and location, then click **Save**.

Categorising Points

When you wish to select a small portion of points and you don't have suitable parameters to use a query filter, you can select points in the scene and assign them to categories. This adds a new column to the points object, preserving the original data.

To start categorising points, right-click on the points object (☰) in the project tree and select **New Category Selection**.

The **New Category Selection** window will appear:

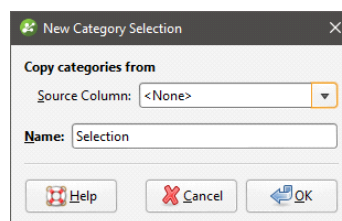

If you select an existing column as the **Source Column**, you can assign selected points to the existing categories or create new categories. If you select **<None>** for the **Source Column**, you will have to define each category manually.

When you click **OK**, the points object will be added to the scene, along with a set of tools for selecting points. To select points, click on the **Select Points** button (📍) and click the **Add Points** button (📏). In the scene, draw a line across each point you wish to select:

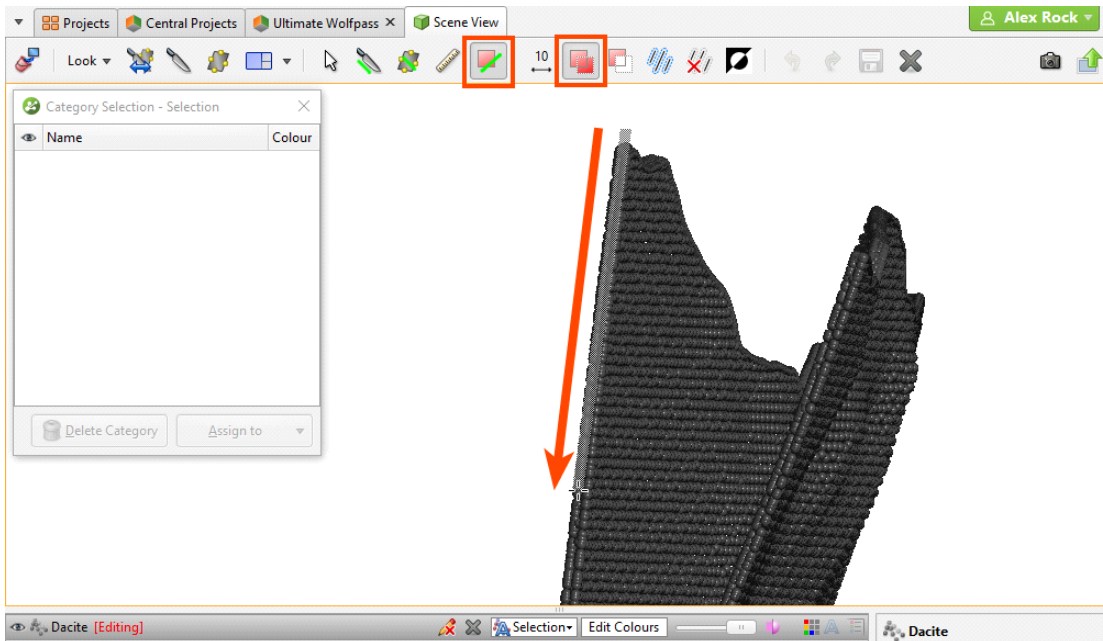

Selected points are highlighted in the scene. If you accidentally select the wrong point, either:

- Click the **Remove Points** button (🗑️) and draw across the point once again.
- Hold the **Ctrl** key while drawing across the point.

You can also:

- Select all visible points by clicking on the **Select All** button (👤) or by pressing Ctrl+A.
- Clear all selected points by clicking on the **Clear Selection** button (🗑️) or by pressing Ctrl+Shift+A.
- Swap the selected points for the unselected points by clicking on the **Invert Selection** button (🔄) or by pressing Ctrl+I.

To change the width of the line used to select points, click on the **Change Line Width** button (📏) and enter a new value. You can keep the **Set Line Width** window open while you select points so you can change the line width as required.

When you have selected at least one point, click on the **Assign to** button, then select **Create New Lithology**:

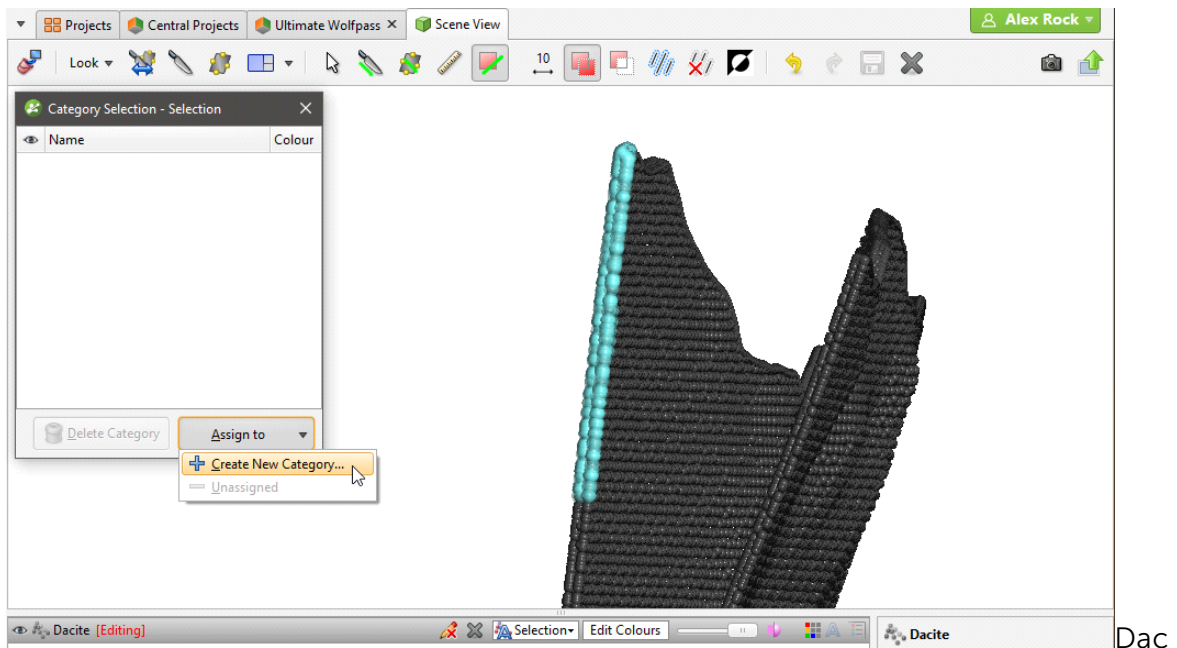

Enter a **Name** for the new category, then click **OK**.

The new category will be created and the scene updated to reflect the changes:

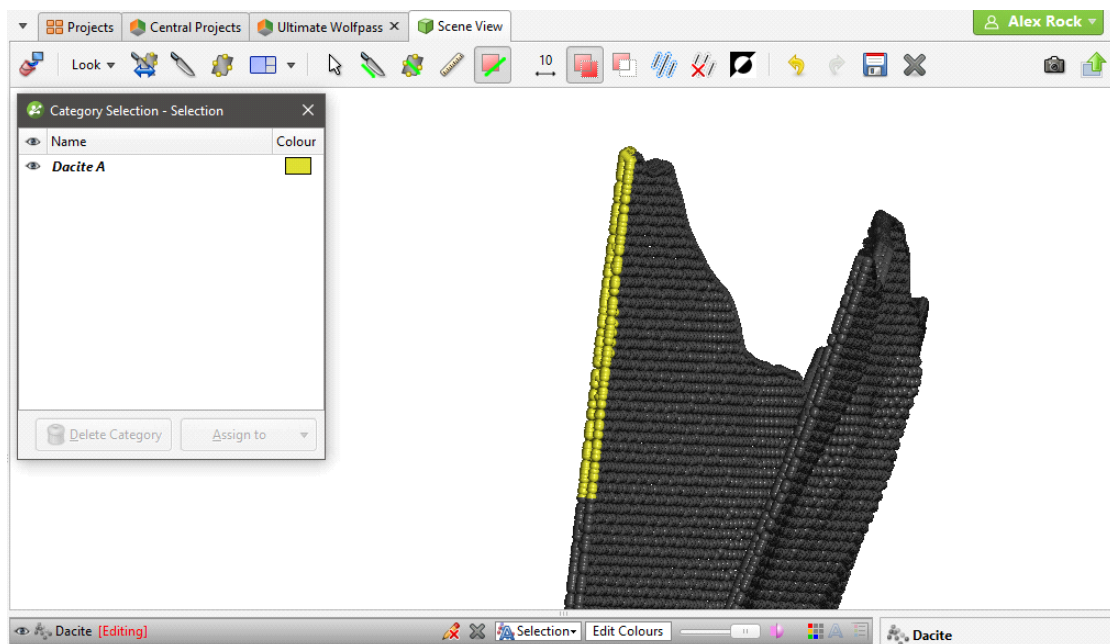

Once you have created a new category, you can add to it by selecting further points, then selecting the category from the **Assign to** list.

When you are finished, click the **Save** button (📁) and close the **Category Selection** window. The new category column will appear in the project tree as an additional column in the points table. Select the new column from the shape list to display it.

Structural Data

In Leapfrog Geo, you can create and edit planar structural data tables directly or from other objects in the project. Structural data can also be used to create and edit many surfaces. Downhole planar structural data and lineations can also be imported, although structural data imported in this way cannot be edited.

This topic describes how to work with structural data in Leapfrog Geo. It covers:

- [Creating New Planar Structural Data Tables](#)
- [Importing Planar Structural Data](#)
- [Importing Lineations](#)
- [Displaying Structural Data](#)
- [Viewing Statistics on Structural Data](#)
- [Assigning Structural Data to Categories](#)
- [Editing the Orientation of Planar Structural Data](#)
- [Declustering Planar Structural Data](#)
- [Setting Elevation for Structural Data](#)
- [Estimating Planar Structural Data](#)

See [Stereonets](#) and [Form Interpolants](#) for information on tools for analysing structural data.

Leapfrog Geo calculates strike using the American right-hand rule; when looking in the strike direction, the plane should dip to the right.

Creating New Planar Structural Data Tables

There are two ways to create a new planar structural data table in Leapfrog Geo:

- Create a new table as part of creating or editing another object. See [Editing Surfaces with Structural Data](#).
- Create a new table using the **Structural Modelling** folder. Use this technique when, for example, you are creating structural data points from a map or image. Right-click on the **Structural Modelling** folder and select **New Planar Structural Data**. In the window that appears, enter a name for the new table and click **OK**.

Before creating the new data table, add the map, image or data object you wish to work from to the scene and orient the scene for drawing the new data points.

When a new structural data table is created, it will be added to the scene. The **Planar Structural Data** window will open, together with a set of tools for adding structural data points:

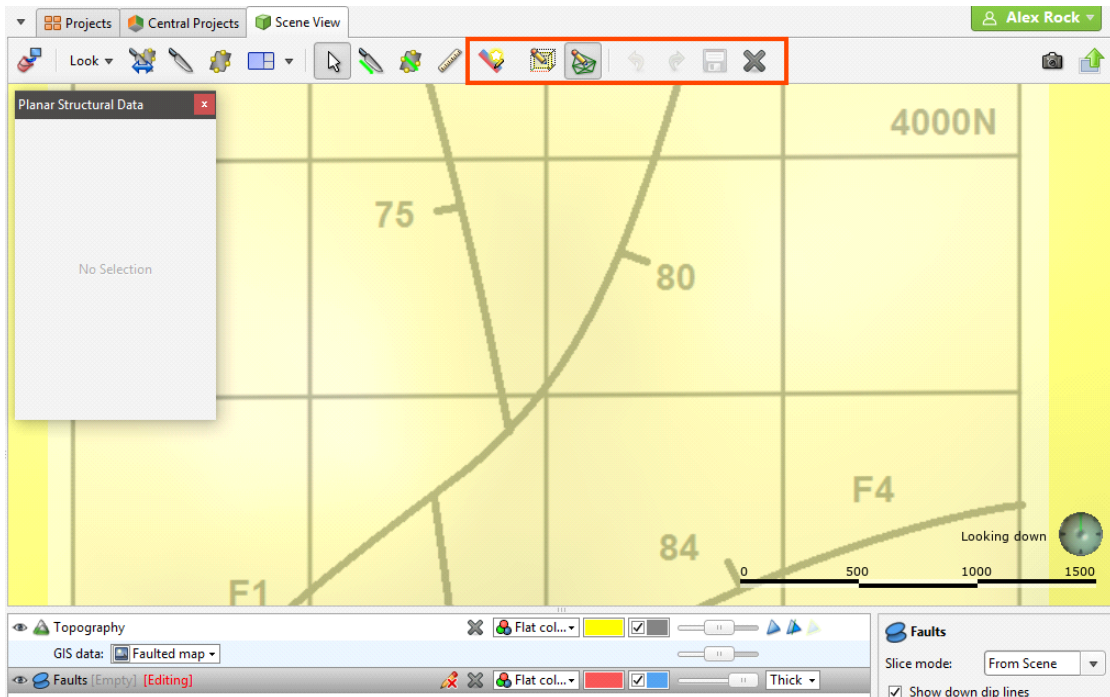

Click on the **New Structural Data Point** button (📌) and click and drag along the strike line in the scene to add a new data point:

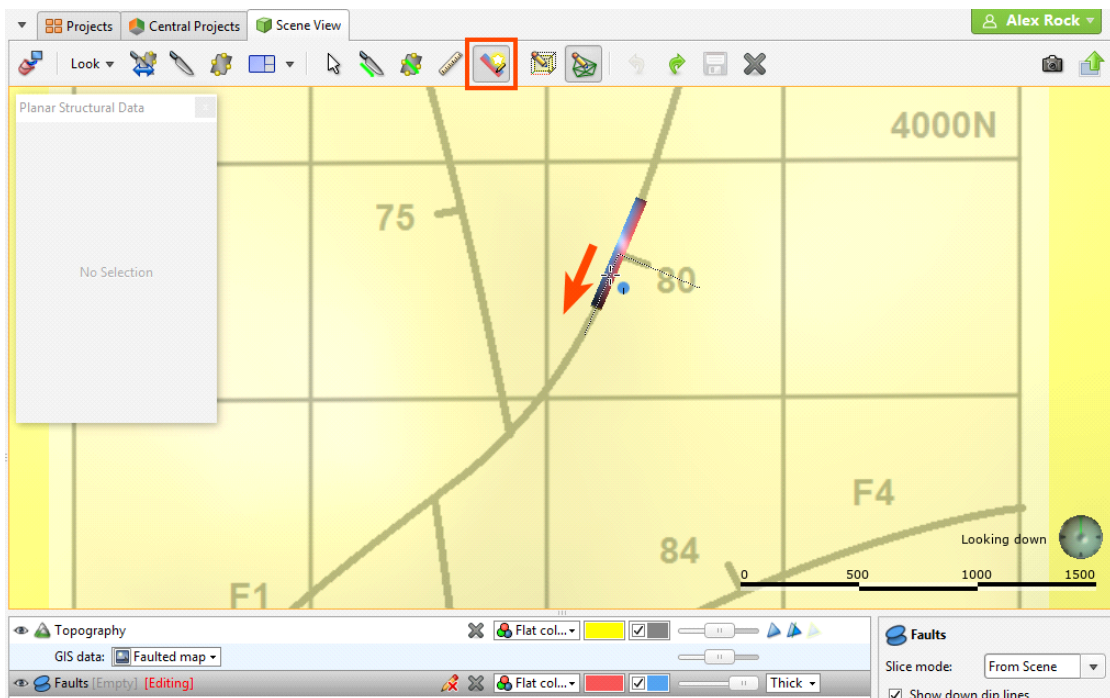

You can adjust the data point using the controls in the **Planar Structural Data** window:

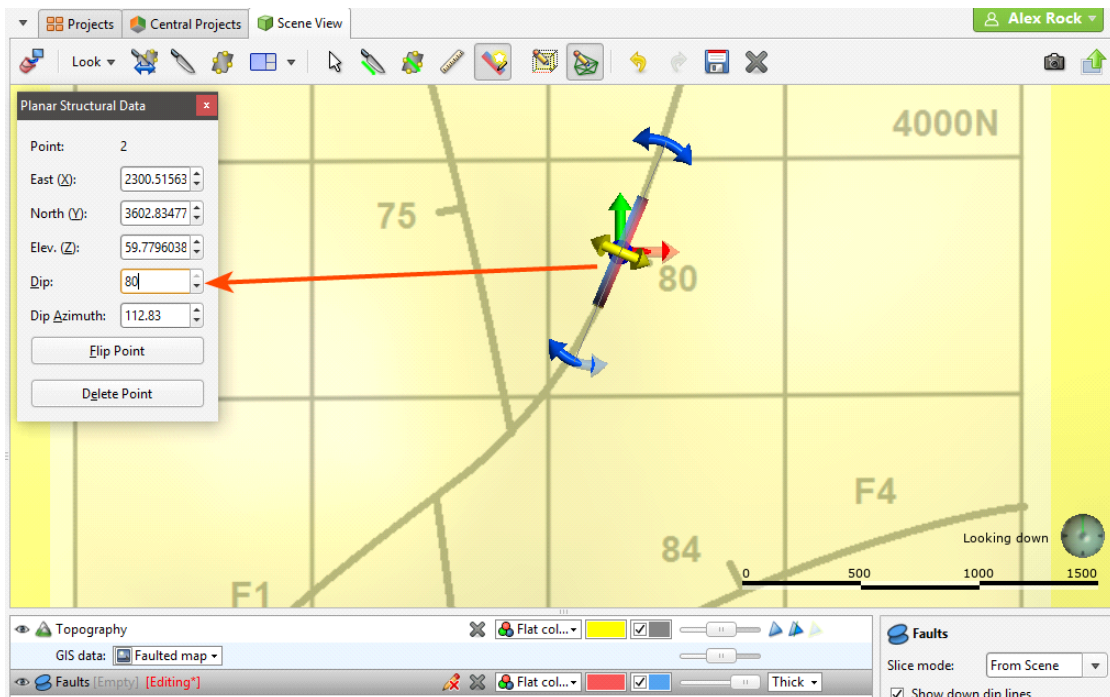

Importing Planar Structural Data

Leapfrog Geo supports planar structural measurements in .csv or text formats. This topic describes importing structural data tables that include location information. Downhole structural data can also be imported, as described in [Importing Downhole Structural Data](#).

Structural data containing location information can be imported from:

- Files stored on your computer or a network location. Right-click on the **Structural Modelling** folder and select **Import Planar Structural Data**. You will be prompted to select a file.
- From any database that runs an ODBC interface. Right-click on the **Structural Modelling** folder and select **Import Planar Structural Data via ODBC**. See [Selecting the ODBC Data Source](#) below.

For each of these options, once the data source is selected, the process of importing the data is the same. Leapfrog Geo will display the data and you can select which columns to import:

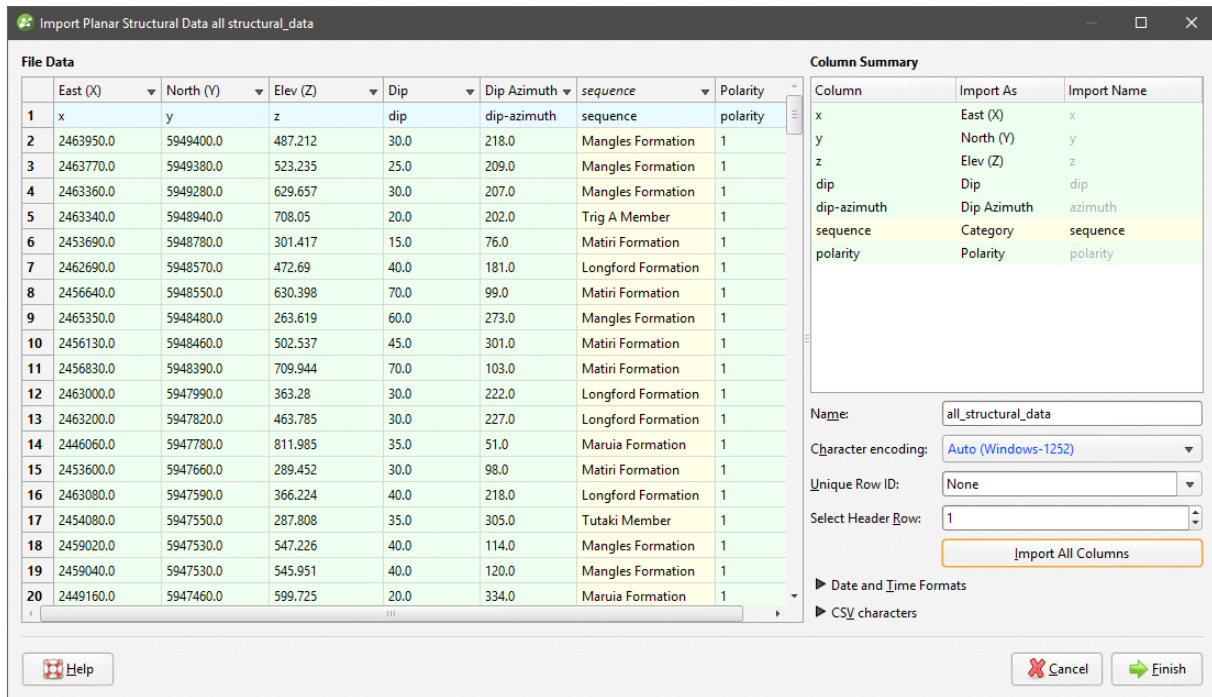

Leapfrog Geo expects **East (X)**, **North (Y)**, **Elev (Z)**, **Dip** and **Dip Azimuth** columns. The **Polarity** column is optional. The **Base Category** column can be used for filtering data once it has been imported.

Click **Finish** to import the data. The structural measurements will appear in the **Structural Modelling** folder.

Once the data has been imported, you can reload and append the data and add columns to the data in a similar manner to drillhole data. See [Appending Drillholes](#), [Reloading Drillhole Data](#) and [Importing Columns](#) for more information.

Selecting the ODBC Data Source

When importing planar structural data from an ODBC database, you will need to specify the ODBC data source. Enter the information supplied by your database administrator and click **OK**.

Once the data source is selected, the import process is similar to that described above.

Importing Lineations

Lineations containing location information can be imported from files stored on your computer or a network location in .csv or text formats. To do this, right-click on the **Structural Modelling** folder and select **Import Lineations**. You will be prompted to select a file.

Leapfrog Geo expects **East (X)**, **North (Y)**, **Elev (Z)**, **Trend** and **Plunge** columns. The **Polarity** column is optional. The **Category** column can be used for filtering data once it has been imported.

Click **Finish** to import the data. The lineations will appear in the **Structural Modelling** folder.

Once the data has been imported, you can reload and append the data and add columns to the data in a similar manner to drillhole data. See [Appending Drillholes](#), [Reloading Drillhole Data](#) and [Importing Columns](#) for more information.

Displaying Structural Data

Planar structural data is displayed as disks and lineations are displayed as cones. There are several ways to change how this data is displayed. In the scene below, planar structural data is displayed using the **Flat colour** option, with positive (red) and negative (blue) sides shown:

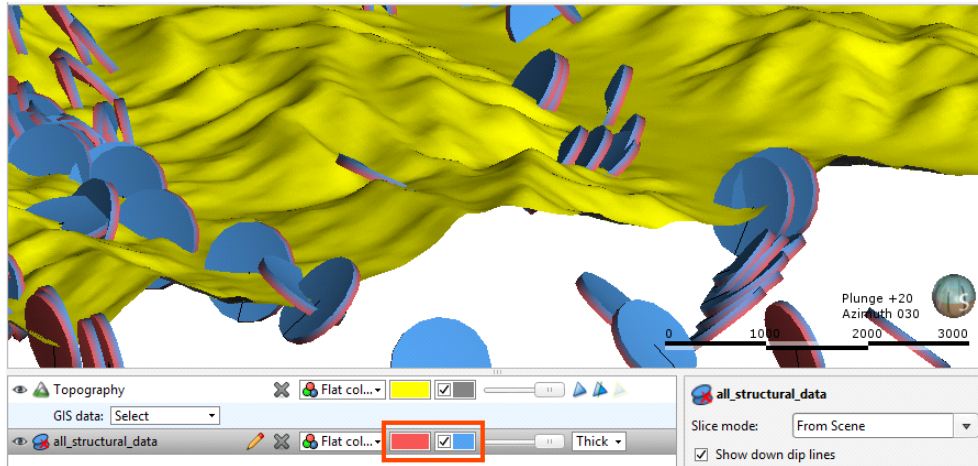

You can change the colours used to display the positive and negative sides using the controls in the shape list. You can also display the data points as **Thick** disks, **Flat** disks or as **Outlined flat** disks. You can change the **Disk radius** and the **Disk size** using the controls in the shape properties panel.

Another way of displaying planar structural data is to display the categories as different colours:

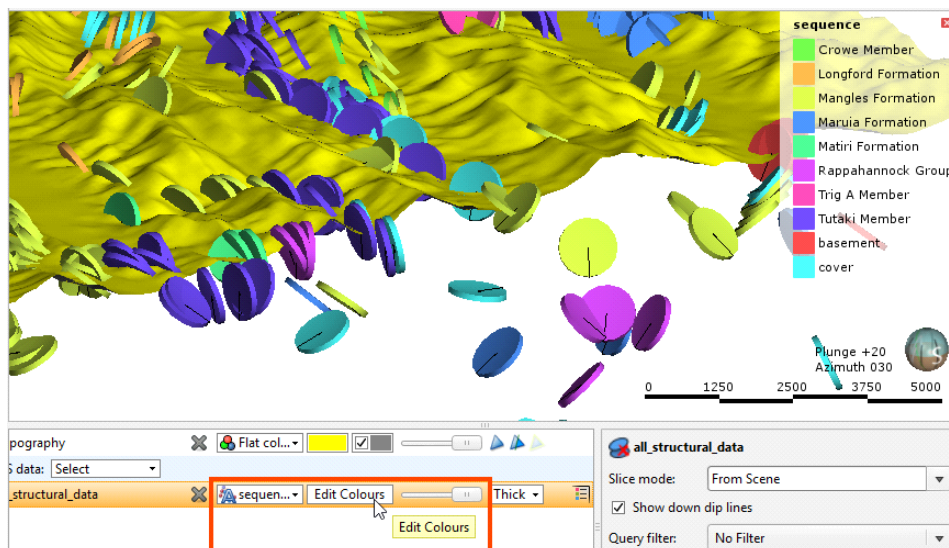

You can change the colours used to display the different categories by clicking on **Edit Colours** in the shape list. In the window that appears, click on the colour chip for each category and change it as described in [Single Colour Display](#).

To set multiple categories to a single colour, use the Shift or Ctrl keys to select the colour chips you wish to change, then click on one of the colour chips. The colour changes you make will be made to all selected categories.

The categories displayed can also be filtered by other columns in the data table, as described in [Filtering Data Using Values and Categories](#).

In the scene below, lineations are displayed using the **Flat colour** option in green:

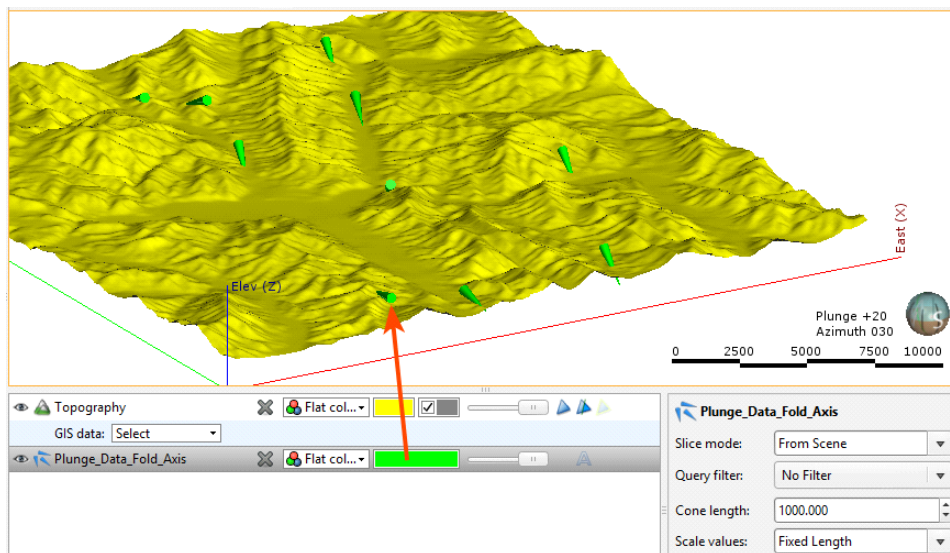

Click the colour chip to change the colour used to display the cones in the shape list or select one of the table's columns:

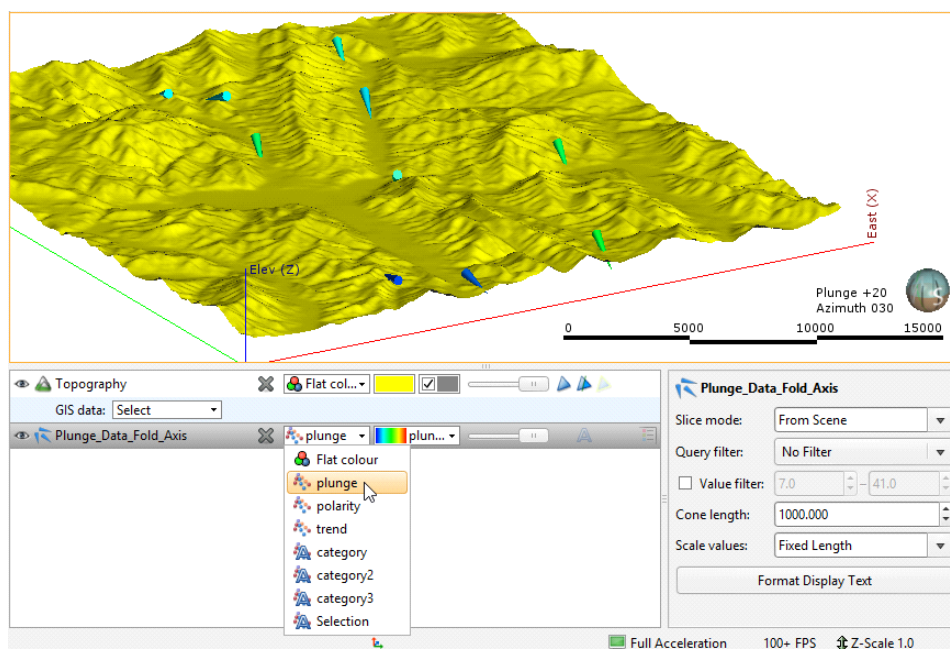

The length of the cones displayed in the scene is set in the properties panel. This can be a **Fixed Length**, defined by the **Cone length** setting, or it can be scaled using the values from one of the table's columns:

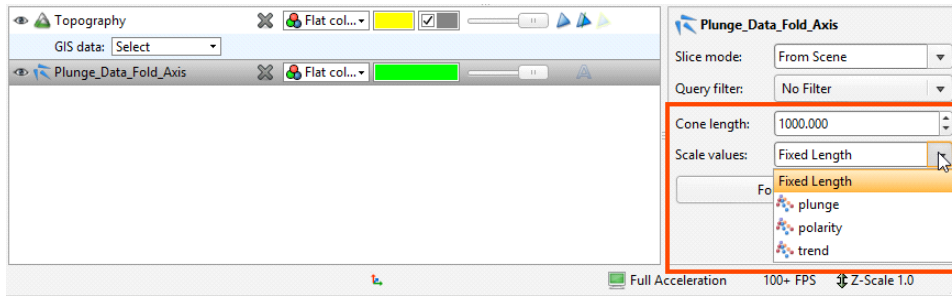

Another way of displaying lineations is to display the categories as different colours:

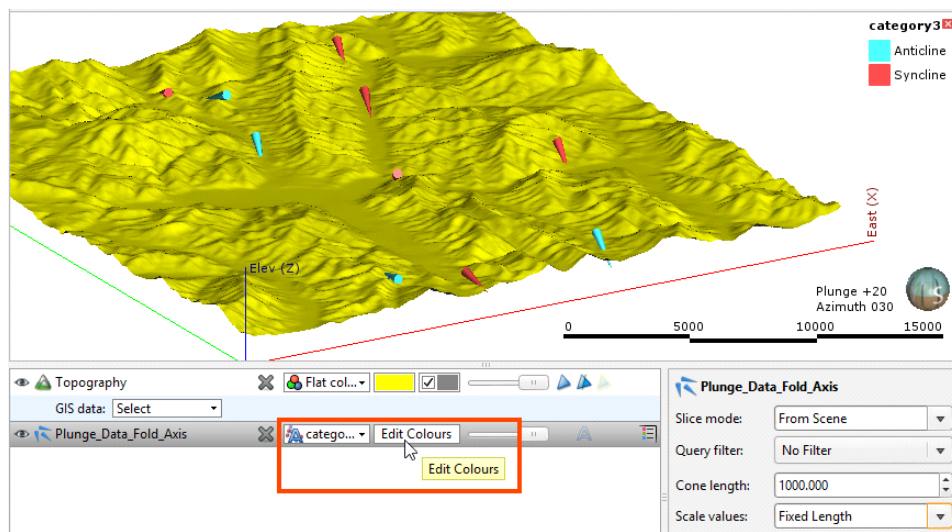

You can change the colours used to display the different categories by clicking on **Edit Colours** in the shape list. In the window that appears, click on the colour chip for each category and change it as described in [Single Colour Display](#).

To set multiple categories to a single colour, use the Shift or Ctrl keys to select the colour chips you wish to change, then click on one of the colour chips. The colour changes you make will be made to all selected categories.

The categories displayed can also be filtered by other columns in the data table, as described in [Filtering Data Using Values and Categories](#).

Viewing Statistics on Structural Data

To view statistics on structural data and lineations, right-click on a table and select **Statistics**. The following options are available:

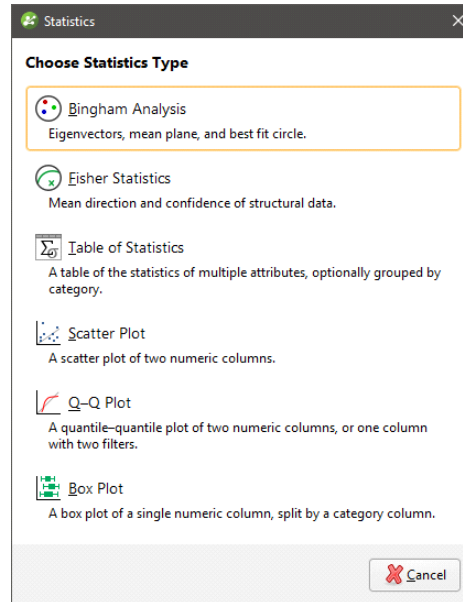

See the [Analysing Data](#) topic for more information on each option:

- [Table of Statistics](#)
- [Scatter Plots](#)
- [Q-Q Plots](#)
- [Box Plots](#)

Bingham Analysis

The **Bingham Analysis** option shows the value, trend and plunge for each of the eigenvectors, along with the Bingham mean plane and best-fit great circle:

Category	Count		Value	Trend	Plunge		Strike	Dip	Dip Az.
All Data	127	e1:	0.604	287.0	82.9	Mean plane:	17.0	7.1	107.0
		e2:	0.358	99.7	7.0	Best fit great circle:	279.8	89.1	9.8
		e3:	0.037	189.8	0.9				
Bedding									
Base	52	e1:	0.900	39.2	86.5	Mean plane:	129.2	3.5	219.2
		e2:	0.077	186.7	2.9	Best fit great circle:	6.7	88.1	96.7
		e3:	0.023	276.7	1.9				
Bedding1	37	e1:	0.613	277.2	23.8	Mean plane:	7.2	66.2	97.2
		e2:	0.387	97.6	66.2	Best fit great circle:	97.3	89.9	187.3
		e3:	0.000	7.3	0.1				
Bedding2	26	e1:	0.633	107.0	12.5	Mean plane:	197.0	77.5	287.0
		e2:	0.367	287.0	77.5	Best fit great circle:	287.0	90.0	17.0
		e3:	0.000	197.0	0.0				
Bedding3	12	e1:	0.828	270.6	31.6	Mean plane:	0.6	58.4	90.6
		e2:	0.160	104.2	57.6	Best fit great circle:	94.4	83.8	184.4
		e3:	0.011	4.4	6.2				

You can select specific rows and copy them to the clipboard or copy all data to the clipboard. You can also export the data in *.csv format.

Fisher Statistics

The **Fisher Statistics** option shows the Fisher mean plane and confidence for the data in the selected table:

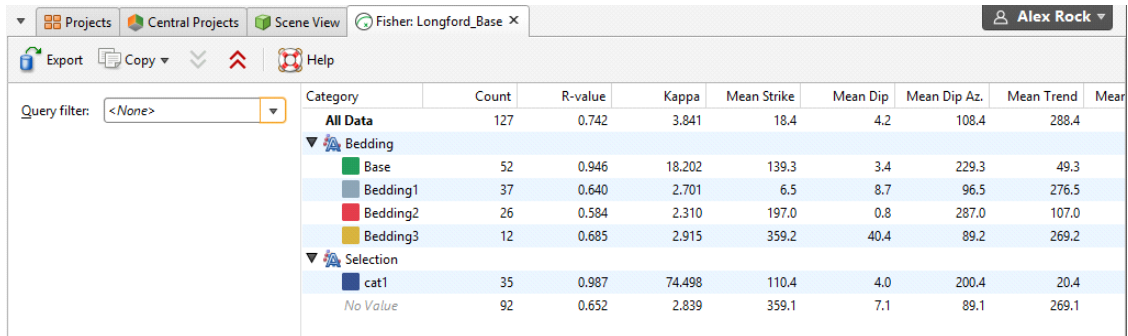

Category	Count	R-value	Kappa	Mean Strike	Mean Dip	Mean Dip Az.	Mean Trend	Mean
All Data	127	0.742	3.841	18.4	4.2	108.4	288.4	
Bedding								
Base	52	0.946	18.202	139.3	3.4	229.3	49.3	
Bedding1	37	0.640	2.701	6.5	8.7	96.5	276.5	
Bedding2	26	0.584	2.310	197.0	0.8	287.0	107.0	
Bedding3	12	0.685	2.915	359.2	40.4	89.2	269.2	
Selection								
cat1	35	0.987	74.498	110.4	4.0	200.4	20.4	
No Value	92	0.652	2.839	359.1	7.1	89.1	269.1	

You can select specific rows and copy them to the clipboard or copy all data to the clipboard. You can also export the data in *.csv format.

Assigning Structural Data to Categories

There are two ways to initiate structural data selection: from the data object in the project tree/shape list and from a stereonet. The advantage of initiating structural data selection from a stereonet is that the data will be displayed both on the stereonet and in the scene window. This provides the most flexibility for analysing what data belongs to what category. See [Selecting Data in the Stereonet](#) and [Using the Scene Window with the Stereonet](#) for more information.

If you wish to assign planar structural data points or lineations to categories, right-click on the data table in the project tree and select **New Category Selection**. First, select the **Source Column**. If you select an existing column as the **Source Column**, you can assign selected data points to existing categories or create new categories. If you select **<None>** for the **Source Column**, you will have to define each category manually.

Select points by clicking on the **Select points** tool (📍), then drawing over those points in the scene:

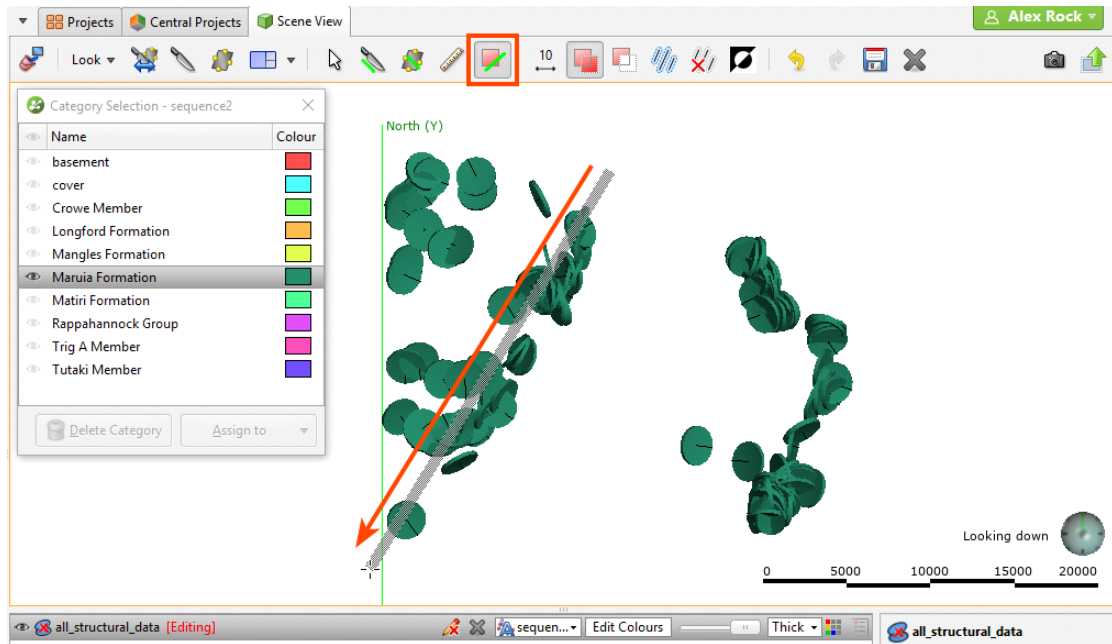

Once you have selected points, you can assign them to existing categories or create new ones. To create a new category, click on the **Assign to > Create New Category** button:

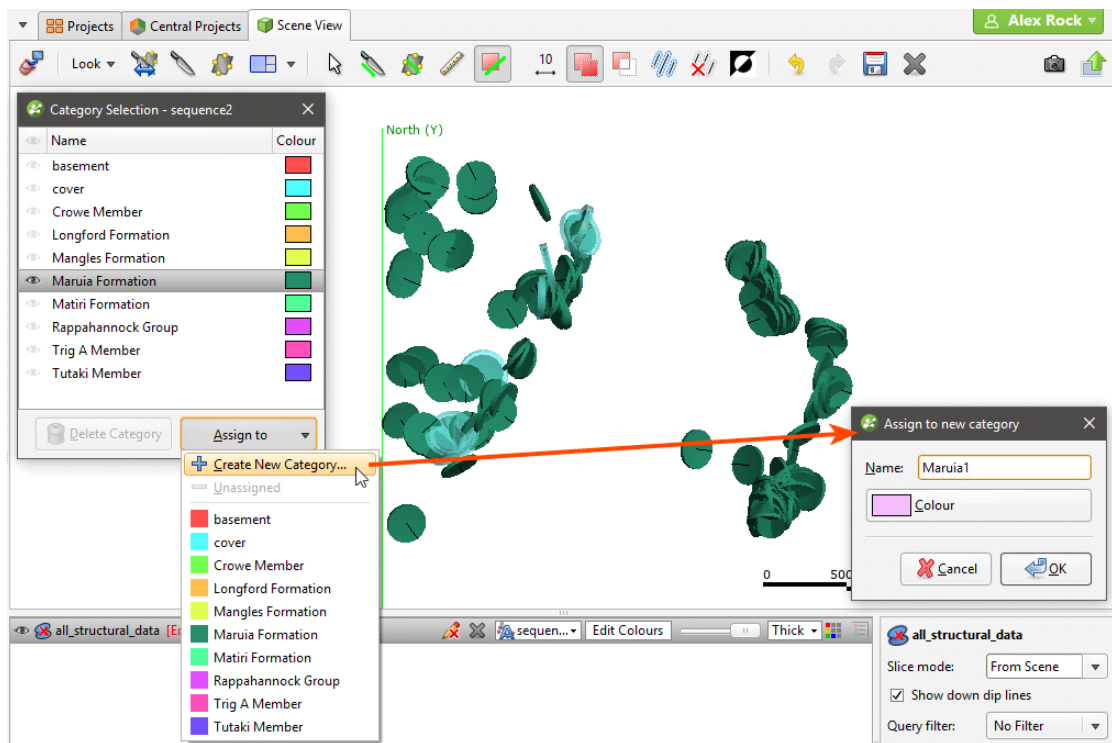

Enter a name for the new category and click **OK**.

When you have finished selecting points and adding them to categories, close the **Category Selection** window to close the editor.

Editing the Orientation of Planar Structural Data

If you need to edit the orientation of planar structural data points, you can do so in two ways:

- Edit the data in the table directly by double-clicking on the structural data table in the project tree. See [Working with Data Tables](#).
- Edit the structural data orientation in the scene.

To edit the structural data in the scene, right-click on the table in the project tree and select **Edit Orientation in Scene**. If the table is displayed in the scene, in the shape list, click on the **Edit** button (✎). The **Planar Structural Data** window will appear in the scene, together with controls for editing the data points. To edit a data point, click on it. Information about the selected point will be displayed in the **Planar Structural Data** window, together with controls in the scene you can use to adjust the point:

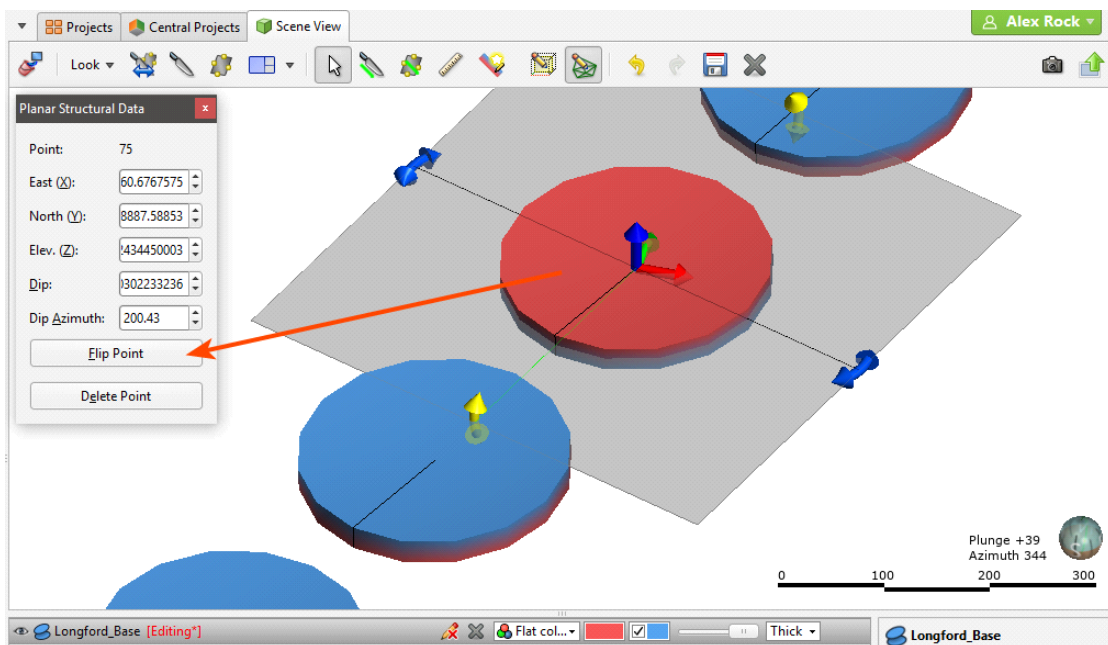

You can also add new data points in the same manner described in [Creating New Planar Structural Data Tables](#).

Declustering Planar Structural Data

If a planar structural data table contains multiple duplicate or near-duplicate measurements, you can create a declustered structural data set that will make the table easier to work with. Declustering is intended to work with large, machine-collected data sets rather than smaller sets that might be edited manually.

Declustering preserves the original data table and creates the set as a “filter” by applying two parameters: the **Spatial search radius** and the **Angular tolerance**.

- The **Spatial search radius** determines the size of the declustering space. All points inside the **Spatial search radius** are compared searching for duplicates.

- The **Angular tolerance** measures whether points have the same or similar orientation. The orientation of all points inside the **Spatial search radius** is measured and the mean taken. If a point's orientation is less than the **Angular tolerance** from the mean, then the point is regarded as a duplicate. The point that is retained is the one that is closest to the mean.

When a structural data set has a numeric column that gives some indication of the measurement's uncertainty, this column can be used to prioritise values. Select the **Priority column** and set how the values should be handled.

Another factor in declustering the points is the category columns selected. When you choose multiple category columns, all criteria must match for points to be regarded as duplicates. What this means is that points will be kept if they have different category values in just one column, even if they meet the criteria for duplicates established by the **Spatial search radius** and the **Angular tolerance** and match in other columns. For example, in this table, assume that applying the **Spatial search radius** and the **Angular tolerance** parameters without using the Lithology category results in three points. However, including the Lithology column results in five points, indicated by the colours:

Dip	Dip-azimuth	Lithology
25	334	A
25	334	A
25	334	B
25	139	C
25	139	C
25	139	C
15	114	B
15	114	B
15	114	A

The more columns you select, the lower the likelihood that points will be regarded as duplicate. The declustered set can be used like an ordinary structural data table. However, it is a filter on a planar structural data table and can be used as such when the parent table is displayed in the scene. For example, here the filters available for the planar structural data table include the query filters (🔍) defined for the table as well as the declustered set (🌐):

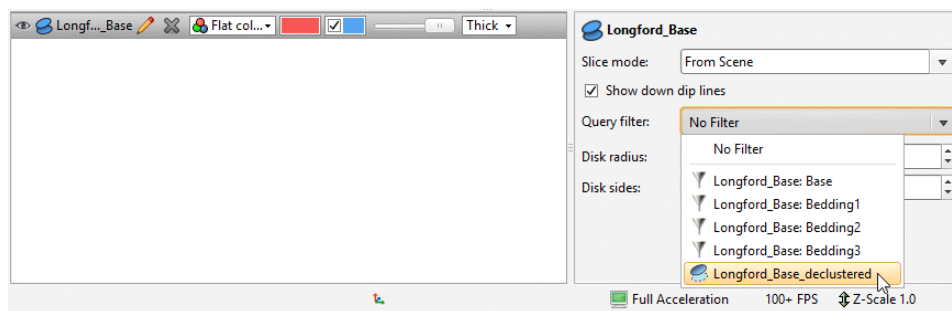

To create a declustered structural data set, right-click on the **Structural Modelling** folder and select **New Declustered Structural Data**. Select the source data table and a query filter, if required. Set the parameters and the columns you wish to use, then click **OK**. The declustered set will be added to the **Structural Modelling** folder.

Edit the set by right-clicking on it in the project tree and selecting **Edit Declustered Structural Data**.

Setting Elevation for Structural Data

You can set the elevation for planar structural data points or lineations by projecting the data onto a surface. Any elevation data in the data table will be overwritten by the elevation values from the selected surface.

To set the elevation for planar structural data points or lineations, right-click on the table in the project tree and select **Set Elevation**. The **Set Elevation from Surface** window will appear:

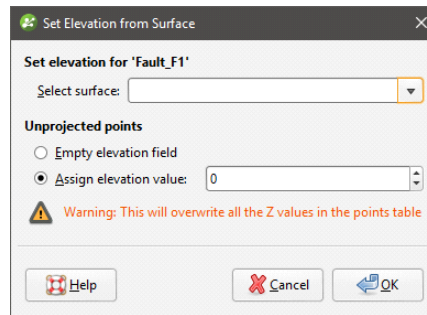

Select from the surfaces available in the project.

Unprojected points are data points that do not vertically intersect the selected surface. There are two options for handling these points:

- Leave the elevation field empty.
- Assign a fixed elevation value.

Click **OK** to set elevation values.

Estimating Planar Structural Data

You can generate a set of planar structural measurements from points, polylines and GIS lines. To do this, right-click on the points or lines object in the project tree and select **Estimate Structural Data**. In the window that appears, enter a name for the structural data table, then click **OK**. The new structural data table will appear in the project tree and you can view and edit it as described in [Displaying Structural Data](#) and [Editing the Orientation of Planar Structural Data](#).

Meshes

In Leapfrog Geo, meshes are used to represent surfaces in the form of vertices and triangles that define the 3D shape of the surface. Meshes can be open or closed. Meshes are generated as part of the model-building process, but can also be imported into a project or created directly in the project. Leapfrog Geo has several tools for adjusting meshes.

The **Meshes** folder contains all meshes imported into Leapfrog Geo and created in Leapfrog Geo outside of the model building process.

Two types of meshes are stored in the **Meshes** folder:

- Non-editable meshes (📄) are meshes imported into Leapfrog Geo and meshes created in Leapfrog Geo from the moving plane, **Meshes > Mesh Operations** tools and by extracting mesh parts from other surfaces in the project.
- Editable meshes (🌐) are created in Leapfrog Geo from data objects such as points data, GIS data and polylines. Editable meshes can be refined by adding more data. Editable meshes can be interpolated meshes (using FastRBF) or triangulated meshes (using Delaunay triangulation). Interpolated meshes can also be created from structural data and values objects.

The rest of this topic is divided into:

- [Cleaning Up a Mesh](#)
- [Importing a Mesh](#)
- [Reloading a Mesh](#)
- [Displaying Surfaces](#)
- [Importing Meshes from Central](#)
- [Exporting Meshes](#)

Cleaning Up a Mesh

There are several options for cleaning up a mesh that can be applied to meshes imported into Leapfrog Geo and to non-editable meshes created in Leapfrog Geo.

To clean up a mesh, double-click on the mesh in the **Meshes** folder or right-click on the mesh and select **Open**. The **Cleanup Mesh** window will be displayed:

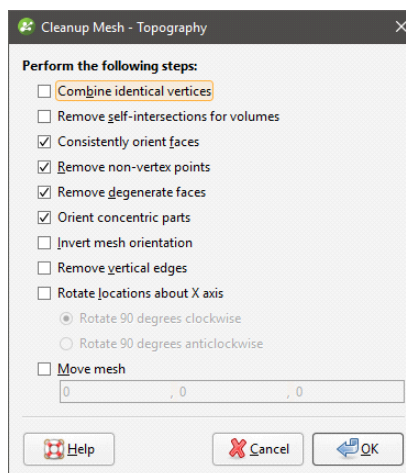

The **Cleanup Mesh** window will also be displayed when you import meshes.

The first option, **Combine identical vertices**, is intended for snapping cases where vertices occupy the exact same point in space. When enabled, vertices that have the exact same coordinates will be merged.

When enabled, **Combine identical vertices** occurs before the other processing actions in the **Cleanup Mesh** window.

The next option, **Remove self-intersections for volumes**, retriangulates self-intersecting triangles and trims away remaining open surfaces, whether they lie inside or outside the mesh. Before applying the **Remove self-intersections for volumes** option, check whether the mesh is open or closed. To do this, right-click on it in the project tree and select **Properties**. **Closed** should be True:

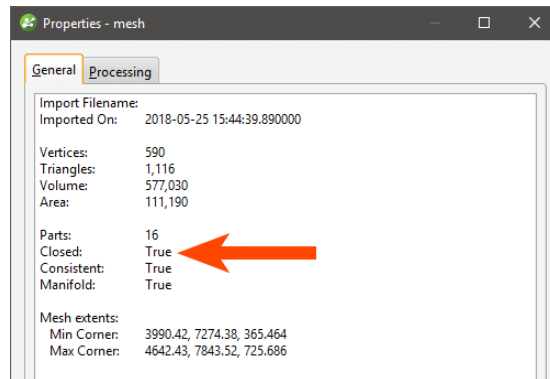

A mesh may appear to be closed in the scene but the **Closed** property will be false. Such a mesh may be made up of open parts that do not join up perfectly to make a closed mesh. If **Remove self-intersections for volumes** is enabled for such a mesh, it may disappear when it is trimmed.

Remove self-intersections for volumes should not be enabled for surface-like open meshes.

You may wish to enable **Remove self-intersections for volumes** if a mesh is reporting as open but is more volume-like than surface-like. Such a mesh may have a single open part that needs to be removed, or it may have open parts that line up perfectly and can be retriangulated to form a closed mesh.

The next four options are automatically applied to meshes created in or imported into Leapfrog Geo:

- **Consistently orient faces** ensures that a mesh can be used for inside/outside testing.
- **Remove non-vertex points** removes points that are not used by any triangles.
- **Remove degenerate faces** removes triangles with duplicate vertices.
- **Orient concentric parts** ensures that internal parts have the correct orientation.

Other options are:

- **Invert mesh orientation** reverses the polarity of the mesh.
- **Remove vertical edges** removes any vertical faces from the mesh boundary.
- **Rotate locations about X axis** lets you rotate the mesh 90 degrees clockwise or anticlockwise.
- **Move Mesh** lets you offset the mesh by a vector. Tick the **Move Mesh** box and enter the required values. The offset values can be changed by opening the **Clean Mesh** window once again.

Select the options required, then click **OK**.

The mesh will be added to the project tree under the **Meshes** folder.

Importing a Mesh

Mesh formats Leapfrog Geo supports include:

- Leapfrog Files (*.msh, *.ara)
- Gocad Files (*.ts)
- DXF Files (*.dxf)
- Surpac Files (*.str, *.dtm)
- Gemcom Files (*.tri)
- Datamine Files (*.pt.asc, *.tr.asc)
- Micromine Files (*.MMpt.dat, *.MMtr.dat)
- DXF Polyface Files (*.dxf)
- Alias Wavefront Object Files (*.obj)
- Vulcan Files (*.00t) (with Maptek Link)

If you have the Maptek Link module, you can also import meshes in VULCAN .00t format. Contact Customer Support as described in [Getting Support](#) for more information about licensing the Maptek Link module.

Once a mesh has been imported to the project, you can evaluate it against any interpolant or distance function in the project. See [Evaluations](#) for more information.

To import a mesh, right-click on the **Meshes** folder and select **Import Mesh**. Navigate to the folder that contains the mesh file and select the file. You can select multiple files using the Shift and Ctrl keys. Click **Open** to import the file.

The **Cleanup Mesh** window will be displayed. See [Cleaning Up a Mesh](#). Select the options required, then click **OK**.

The mesh will be added to the project tree under the **Meshes** folder.

Meshes with Textures

Leapfrog Geo can import OBJ meshes with textures. If you have the Maptek Link module, you can also import Vulcan 8 meshes with textures.

Textured OBJ Meshes

For OBJ meshes, a materials file (.mtl) is required, together with the referenced images. Image formats supported include:

- PNG Files (*.png)
- JPEG Files (*.jpg, *.jpeg)

- TIFF and GeoTIFF Files (*.tiff, *.tif)
- Windows Bitmap Files (*.bmp)
- Graphics Interchange Format Files (*.gif)

The texture is automatically imported when the mesh is imported and will appear in the project tree under the mesh.

Textured Vulcan 8 Meshes

This feature is only available if you have the Maptek Link module.

When importing a Vulcan 8 mesh that contains a path to an associated texture, Leapfrog Geo will also import the texture. If the path to the texture does not exist, you can import it once the mesh has been imported. Do this by right-clicking on the mesh in the project tree and selecting **Import Texture**. Navigate to the folder containing the texture file and click **Open**. The texture will be imported and stored in the project tree as part of the mesh.

Reloading a Mesh

Meshes imported into Leapfrog Geo and created from extracting mesh parts can be reloaded. To do this, right-click on the mesh in the project tree and select **Reload Mesh**. Navigate to the file that should be used and click **Open**.

Displaying Surfaces

Leapfrog Geo assigns different colours to each side of a surface.

A basic mesh will have an inside (coloured red) and an outside (coloured blue):

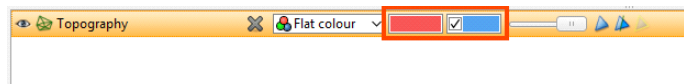

In the case of contact surfaces, each side will be assigned a lithology. "Unknown" will be used if multiple lithologies are contacted. Contact surfaces can be displayed using the assigned lithologies or the younging direction:

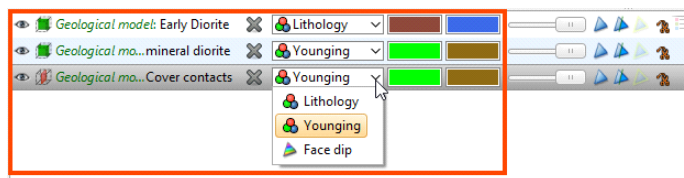

When a contact surface is displayed by its younging direction, the younger side of the surface will be displayed in green and the older side in brown.

Veins can also be displayed coloured with the thickness values.

Surfaces that are part of a geological model or interpolant are, by default, displayed clipped to the model boundary:

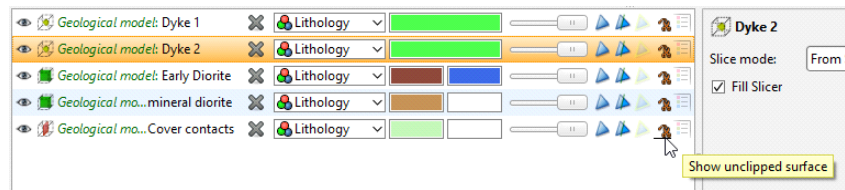

Disable the **Clipped surface** button (🗑️) to view the surface unclipped.

Draping an Image on a Mesh

You can drape images on any mesh in the **Meshes** folder. To do this, right-click on the mesh in the **Meshes** folder and select one of the **Drape Image** options.

- For the **Import Image** option, you will be prompted for a file location. Navigate to the folder containing the image you wish to drape, select the file and click **Open**. Set georeferencing information for the image, if required, then click **OK**. See [Importing a Map or Image](#) for more information on georeferencing images. The imported image will appear in the project tree under the mesh.
- For the **Select Existing Image** option, select from the images available in the project and click **OK**. A hyperlink to the image will appear in the project tree under the mesh.

You can drape as many images as required. When the mesh is displayed in the scene, you will be able to select any draped images from the list of display options.

When you import and georeference an image, you can then export it as a GeoTIFF. To do this, right-click on it in the project tree and select **Export**. You will be prompted for a filename and location. Click **Save**.

Importing Meshes from Central

When you are working in a Central project, you can import meshes from other Central projects on the same server. Importing meshes from Central allows you to easily share data between projects without having to manually export and re-import the data. In addition, if the mesh is out-of-date, you can reload it from Central.

Importing Central Meshes

To import a mesh from Central, first make sure you are already connected to Central. Then right-click on the **Meshes** folder and select **Import Mesh From Central**. In the window that appears, select one of the projects in the repository. Next, the project history will be displayed. Select a version to view a list of available objects, then click on a model to load its list of surfaces. Here, the surfaces from the Lithology geological model have been loaded, while the surfaces in the **Numeric Models** folder have not:

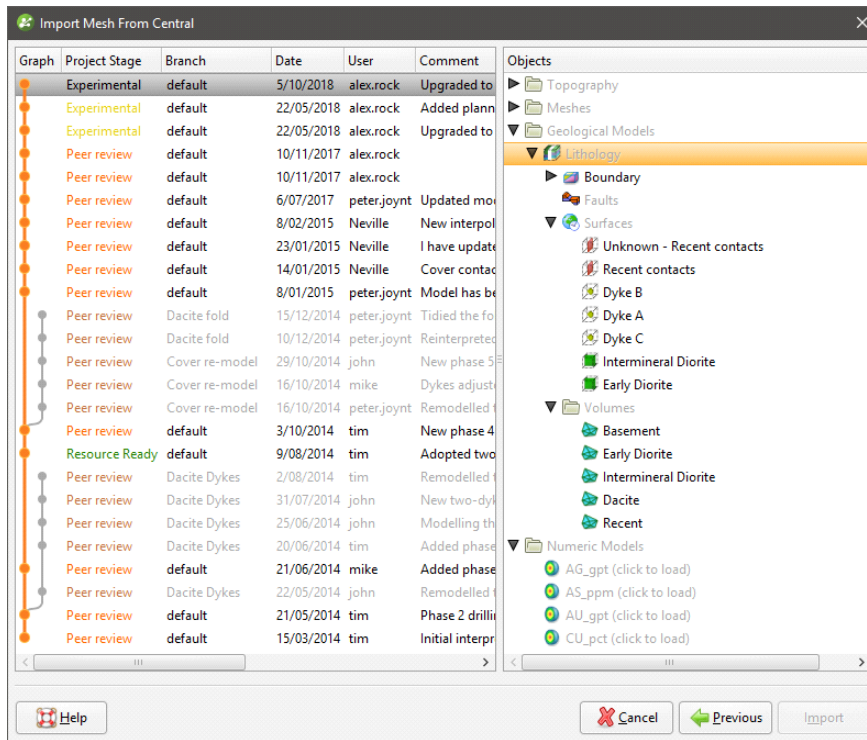

Use the Shift and Ctrl keys to select as many objects as required. Click **Import** to import the objects, which will be saved into the **Meshes** folder.

A different colour is used to indicate meshes imported from Central (📁), and viewing the properties shows you what version of the project the mesh came from:

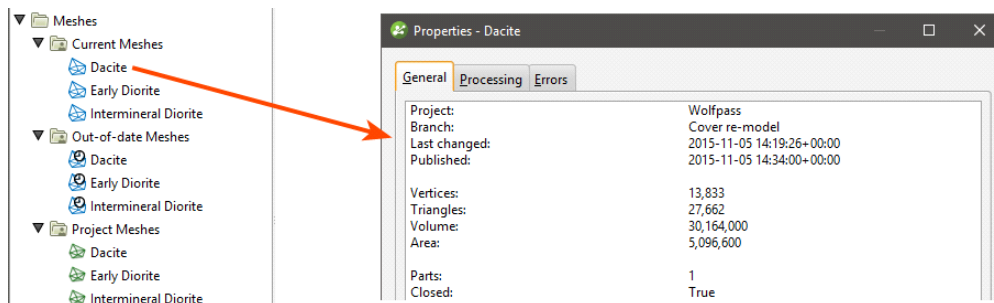

When you import a mesh from Central, Leapfrog Geo checks to see if the mesh is the latest version from that branch. Out-of-date meshes (📁) are indicated in the project tree.

Updating Out-of-Date Meshes

There are two options for updating an out-of-date mesh:

- **Reload Latest on Branch** imports the newest mesh available on the branch the out-of-date mesh was imported from.
- **Reload From Central** displays the project history and allows you to pick any point in time on any branch.

Right-click on a mesh and choose one of these options.

If you have selected multiple meshes in the project tree, the **Reload Latest on Branch** option is the only one available:

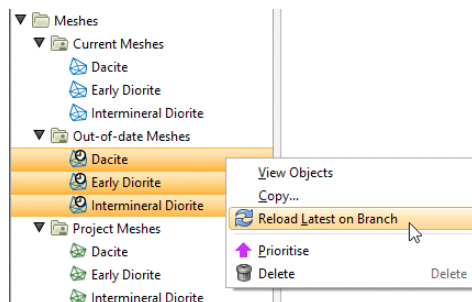

Exporting Meshes

Leapfrog Geo exports meshes in the following formats:

- Leapfrog Files (*.msh)
- Gocad Files (*.ts)
- DXF Files (*.dxf)
- Surpac Files (*.dtm, *.str)
- Gemcom Files (*.tri)
- Datamine Files (*.pt.asc, *.tr.asc)
- Micromine Files (*.MMpt.dat, *.MMtr.dat)
- DXF Polyface Files (MineCAD) (*.dxf)
- Alias Wavefront Object Files (*.obj)
- Drawing Files (2013/LT2013) (*.dwg)
- Bentley Drawing Files (v8) (*.dgn)

If you have the Maptek Link module, you can also export meshes in VULCAN .00t format. Contact Customer Support as described in [Getting Support](#) for more information about licensing this module.

You can export single meshes or batch export meshes from the **Meshes** folder or from individual models. Each of these is described below:

- [Exporting a Single Mesh](#)
- [Exporting Multiple Meshes from the Meshes Folder](#)
- [Exporting Multiple Meshes from Models](#)

Exporting a Single Mesh

To export a mesh, right-click on the mesh and select **Export**. The **Export Mesh Parts** window will appear:

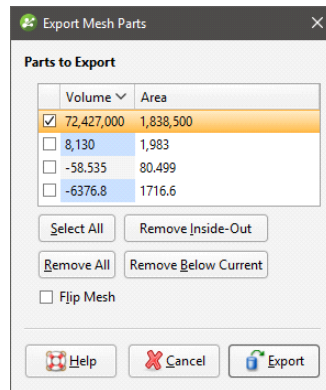

An **Export clipped mesh** option is available for meshes that are clipped to a boundary:

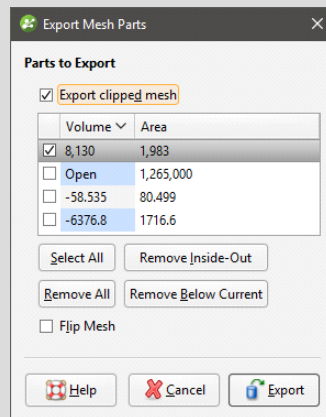

If the quality of the mesh produced is not acceptable, clip the mesh as described in [Clipping a Mesh](#), then export the mesh.

Select the **Parts to Export**, then click **OK**. You will be prompted for a filename and location.

When exporting a mesh that has multiple parts, you can distinguish between the different parts by clicking on them in the **Export Mesh Parts** window. Here, the mesh was added to the scene before the **Export Mesh Parts** window was opened. Clicking on a mesh part in the list selects that part in the scene:

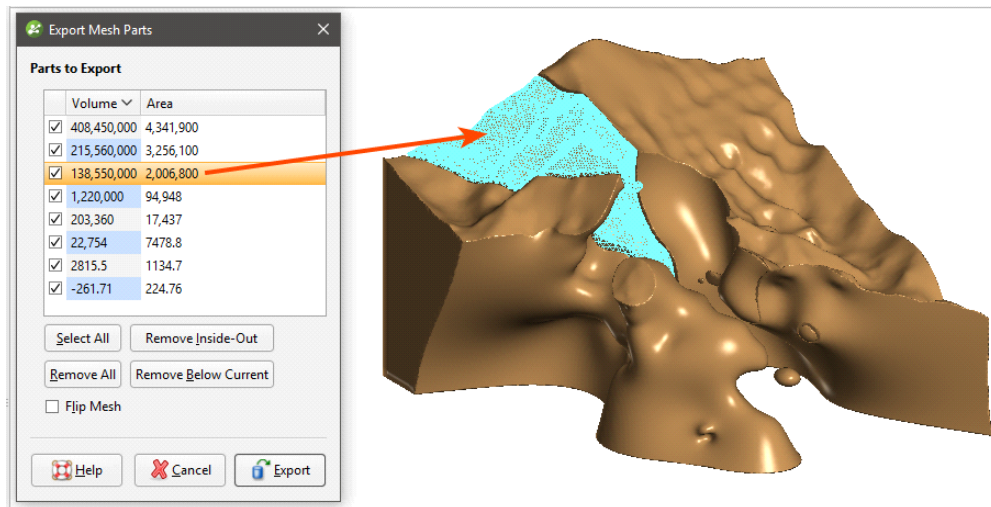

If the mesh is not in the scene when the **Export Mesh Parts** window is opened, selecting a part in the list will display it in the scene without reference to the other parts of the mesh:

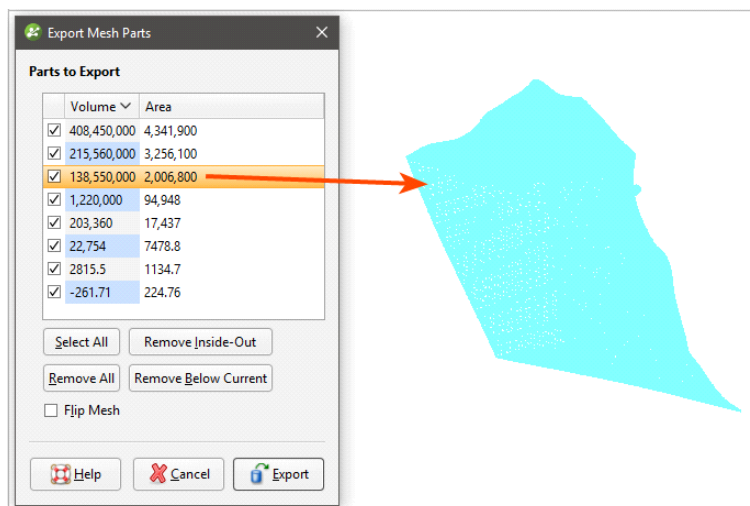

Use the Shift and Ctrl keys to select and view multiple mesh parts in the scene:

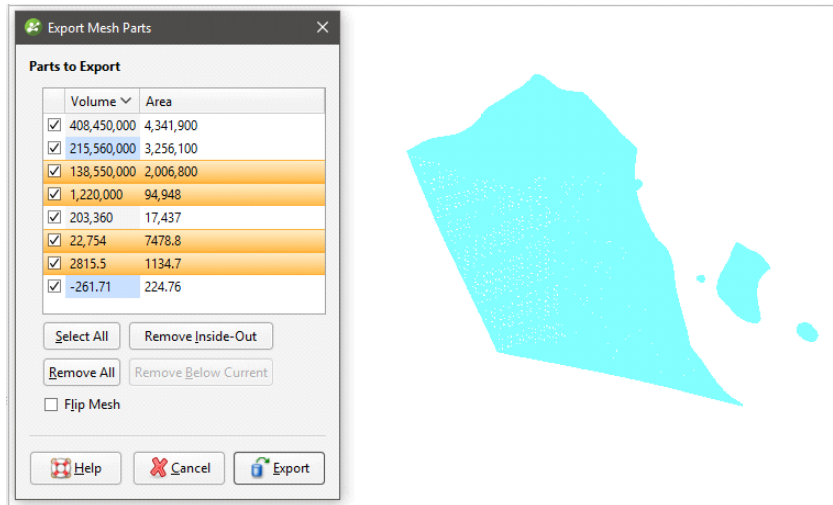

Exporting Multiple Meshes from the Meshes Folder

To export multiple meshes from those in the **Meshes** folder, right-click on the **Meshes** folder and select **Export Meshes**. In the window that appears, select the meshes you wish to export:

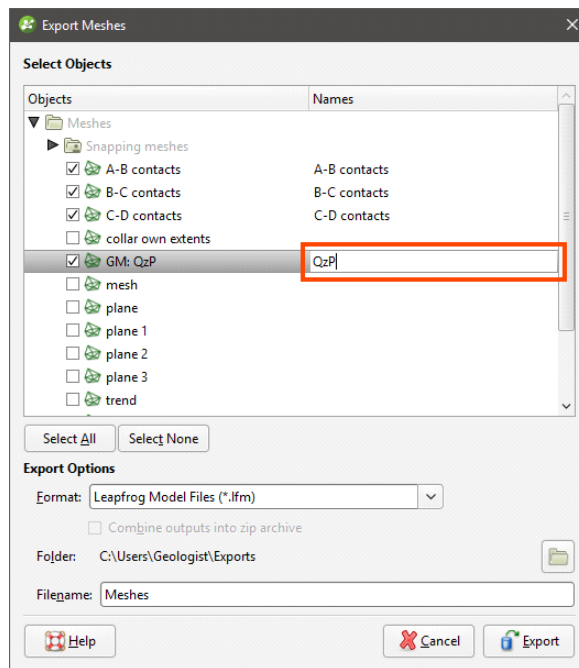

The filename that will be used for each mesh is shown in the **Filenames** column. To change the filename for any of the meshes, click on its name in the **Filenames** column.

Next, select the format required and where to save the exported meshes. Available formats are:

- Leapfrog Model Files (*.lfm)
- Leapfrog Files (*.msh)
- Gocad Files (*.ts)

- DXF Files (*.dxf)
- Surpac Files (*.dtm, *.str)
- Gemcom Files (*.tri)
- Datamine Files (*.pt.asc, *.tr.asc)
- Micromine Files (*.MMpt.dat, *.MMtr.dat)
- DXF Polyface Files (MineCAD) (*.dxf)
- Alias Wavefront Object Files (*.obj)
- Drawing Files (2013/LT2013) (*.dwg)
- Bentley Drawing Files (v8) (*.dgn)

Click **Export** to save the meshes.

Exporting Multiple Meshes from Models

You can export multiple meshes from individual geological models, numeric models, combined models and static models. To export meshes in this way, right-click on a model or interpolant and select **Export**. In the window that appears, select the volumes and surfaces you wish to export:

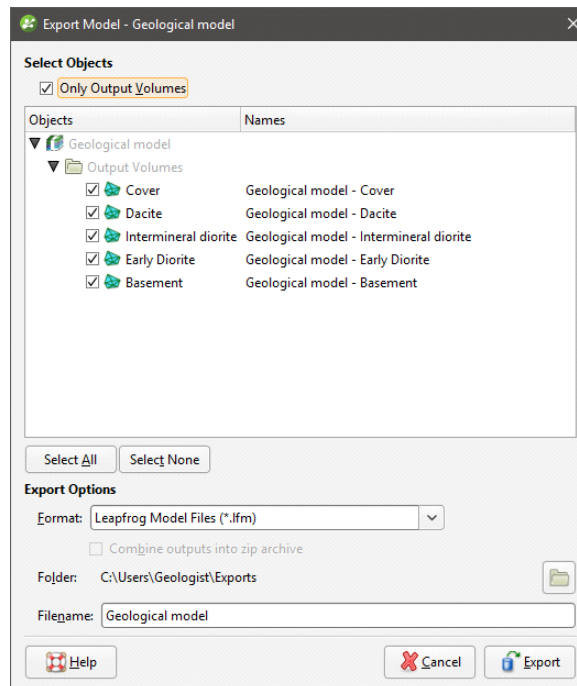

For geological models, if you wish to export surfaces other than the output volumes, untick the **Only Output Volumes** option.

For faulted geological models, you also can select from the faulted volumes by ticking the **Faulted Volumes** box:

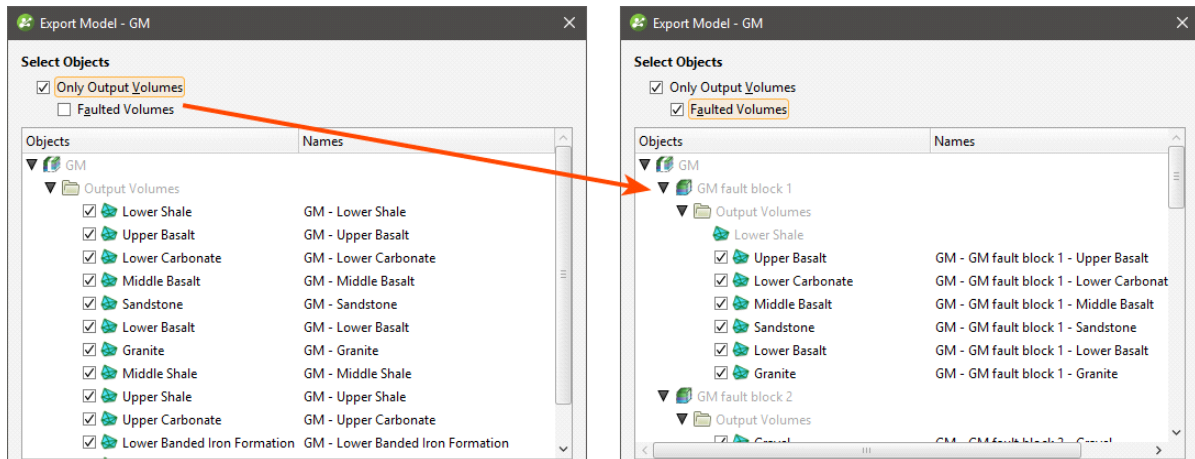

The filename that will be used for each mesh is shown in the **Filenames** column. To change the filename for any of the meshes, click on its name in the **Filenames** column.

Next, select the format required and where to save the exported meshes. Available formats are:

- Leapfrog Model Files (*.lfm)
- Leapfrog Files (*.msh)
- Gocad Files (*.ts)
- DXF Files (*.dxf)
- Surpac Files (*.dtm, *.str)
- Gemcom Files (*.tri)
- Datamine Files (*.pt.asc, *.tr.asc)
- Micromine Files (*.MMpt.dat, *.MMtr.dat)
- DXF Polyface Files (MineCAD) (*.dxf)
- Alias Wavefront Object Files (*.obj)
- Drawing Files (2013/LT2013) (*.dwg)
- Bentley Drawing Files (v8) (*.dgn)

For any of the export options other than Leapfrog Model Files format, you can save the meshes as a zip file.

The Leapfrog Model File format exports a single *.lfm file. If the file is imported into the **Meshes** folder, each output volume will appear as a single mesh.

Click **Export** to save the meshes.

Modifying Surfaces

This topic describes aspects of modifying surfaces in Leapfrog Geo. It is divided into:

- [Surface Resolution in Leapfrog Geo](#)
- [Adding Data to Surfaces](#)
- [Honouring Surface Contacts](#)
- [Global Trends](#)
- [Structural Trends](#)
- [Editing Surfaces with Polylines](#)
- [Editing Surfaces with Structural Data](#)

Surface Resolution in Leapfrog Geo

In Leapfrog Geo, meshes are used to represent surfaces in the form of vertices and triangles that define the 3D shape of the surface. The resolution of a surface is controlled by the size of the triangles used to create a surface. A lower surface resolution value means smaller triangles and, therefore, a finer resolution. A higher surface resolution value will take less time to process but the surface may not show the level of detail required.

When a surface is imported, Leapfrog Geo automatically sets a surface resolution based on the information in the file. It is not possible to change the resolution of surfaces imported into Leapfrog Geo. The exception is elevation grids (see [Importing an Elevation Grid](#)).

When surfaces are created, Leapfrog Geo sets a default resolution based on the data available. You can set a lower value, but calculations will take longer. In addition, the resolution for many surfaces can be adaptive; that is, areas closer to data will have a finer resolution than areas further away from data.

To see the effect of different resolution settings, consider a simple geological model of three rock types. Here, the surface resolution is set to 50 and the adaptive isosurfacers are disabled:

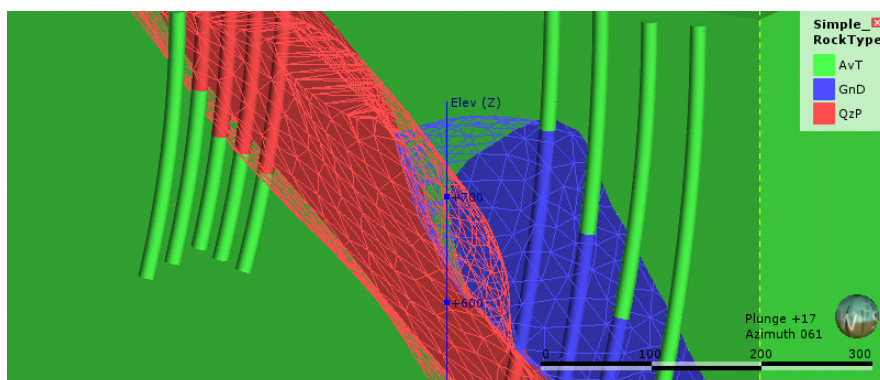

Here, the resolution has been reduced, which results in smaller triangles:

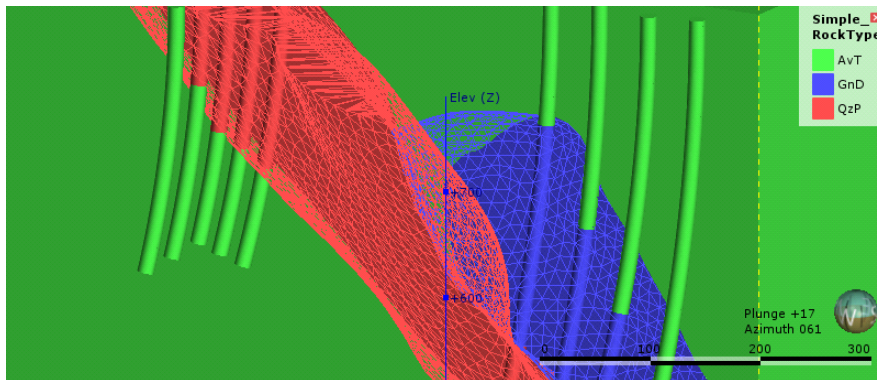

For both resolution settings above, the triangles are the same size everywhere in each surface, even where real data is available. Once the adaptive isosurfacers has been enabled, the triangles closer to the drillholes are smaller than those further away:

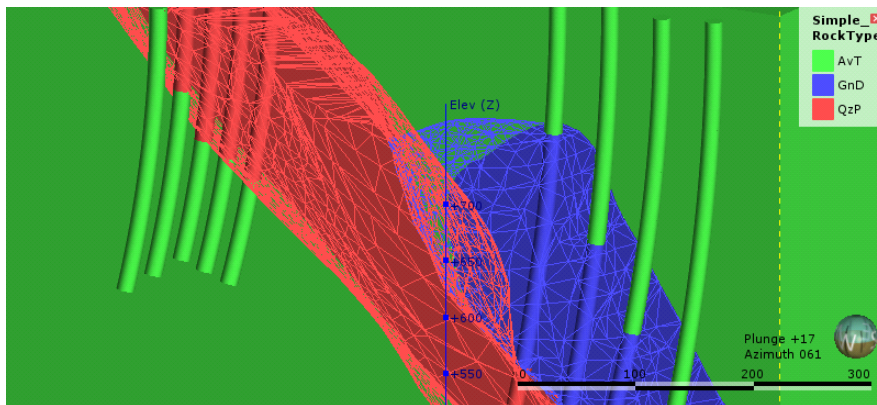

Areas of the surface that have large triangles indicate that there is less data in those areas to guide the interpolation of the surface.

In Leapfrog Geo, the resolution for different types of surfaces can be controlled as follows:

- For geological models, a resolution can be set for the model as a whole, but individual surfaces can have different settings. See [Surface Resolution for a Geological Model](#).
- For interpolants, the resolution of the output isosurfaces is controlled by a single setting that can be overridden for individual surfaces. See [Output Settings for an RBF Interpolant](#) and [Indicator RBF Interpolant Surfacing and Volume Options](#).
- The resolution can be changed for editable interpolated meshes (🌐) and can be adaptive. See [Interpolated Meshes](#).
- When the topography has been defined using multiple data sources, the resolution can be set and the adaptive option is available. See [Changing Topography Settings](#).

Adding Data to Surfaces

Many surfaces can be refined by adding points, structural data, GIS data and polylines. If a surface can be modified in this way, an **Add** menu will appear for the object when you right-

click on it in the project tree. For example, the **Add** menu for this contact surface shows the data types that can be used to refine the surface:

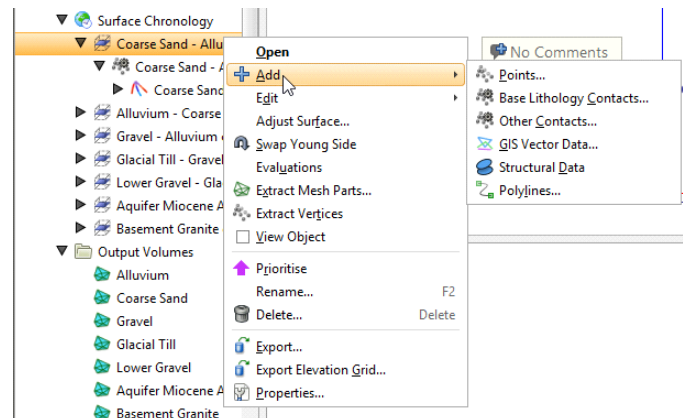

Select the type of data you wish to use to modify the surface. Leapfrog Geo will display all the suitable objects in the project. Select the required object and click **OK**. A hyperlink to the added data will appear under the surface in the project tree. The added data can be removed from the surface by expanding the surface in the project tree, then right-clicking on the hyperlinked data object and selecting **Remove**.

Honouring Surface Contacts

In Leapfrog Geo, surfaces can be created from drillhole data, points data, structural data, GIS data and polylines. When surfaces are created from several different objects, it may be desirable to snap the surface to some data objects but not to others.

There are several options for snapping surfaces to data:

- **Off**. The surface does not snap to the data used to create it.
- **All data**. The surface snaps to data within the **Maximum snap distance**, which includes drillhole data and any data added to the surface.
- **Drilling only**. The surface snaps to drillhole data and data objects derived from drillhole data within the **Maximum snap distance** but not to other data used to modify the surface. For example, the surface will honour points data derived from drillhole data, but not points data imported into the **Points** folder.
- **Custom**. The surface snaps to selected data objects within the **Maximum snap distance**.

Snapping forces surfaces to honour the specified contacts, moving triangles on the surface so that the surface precisely intersects the contact. For example, snapping is disabled for the surface on the left, but enabled for the surface on the right. The points used to generate the surface are shown in red, and the triangles are displayed so you can see how snapping to data affects the surface:

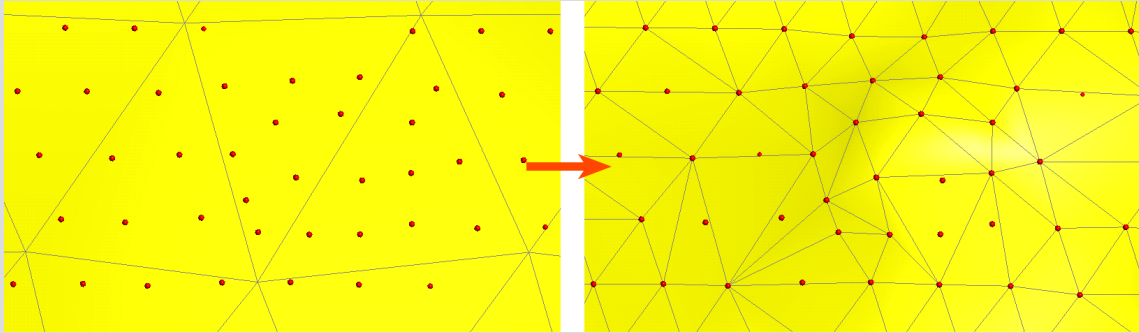

When snapping is enabled, the **Maximum snap distance** is used to determine what data should affect the surface. The **Maximum snap distance** is, by default, set to half of the **Surface resolution** setting, but you can adjust that up or down, if required.

In this image, three surfaces are shown, along with the points used to generate the surface (red). The grey surface is the surface that results when snapping is **Off**. For the yellow surface, snapping to the points is enabled and the **Maximum snap distance** has been set to a high value, resulting in the yellow surface snapping to the distant point indicated by the arrow. Snapping to points is also enabled for the blue surface, but the **Maximum snap distance** has been set to a lower value, so that the surface snaps to some close points, but does not snap to the distant point.

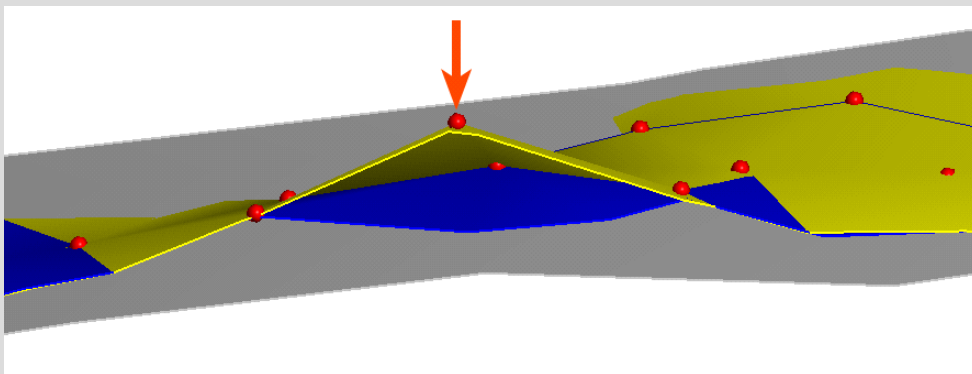

While the most suitable snapping option is always project- and purpose-specific, if you have sufficient drilling data, snapping to **Drilling only** is recommended. This option gives the highest priority to the input data itself while still allowing the surface to be influenced by manual interpretations. Contrary to the **All data** snapping option, the **Drilling only** option also reduces the potential for complications resulting from contradictory data (e.g. the drilling data indicates a surface contact is in one place, but a polyline indicates it's somewhere else).

Take care in enabling snapping and in selecting what data the surface will snap to, as the more data you include, e.g. by setting a large **Maximum snap distance** or selecting **All data** for **Snap to data**, the greater the possibility that errors in the data or assumptions inherent in

interpretations (e.g. polylines) will cause distortions in the meshes. If you do enable snapping, it is best to snap only to drilling data.

For example, here the **Snap to data** has been set to **Drilling only** for a mesh created from multiple data objects:

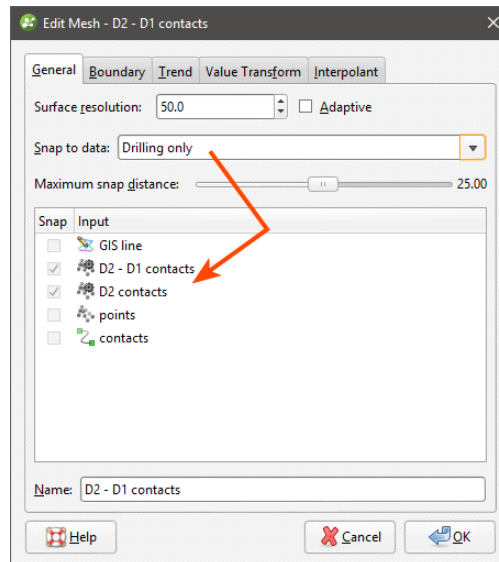

Note that the only objects **Snap** is enabled for are the contacts derived from drillhole data.

Here, **Snap to data** has been set to **Custom**, which makes it possible to enable **Snap** for only the selected data objects:

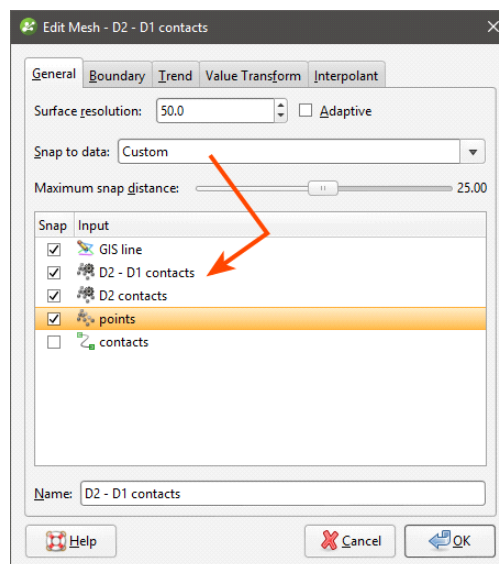

In Leapfrog Geo, the snap settings for different types of surfaces can be controlled as follows:

- For geological models, **Snap to data** can be set for the model as a whole, but individual surfaces can have different settings. For more information, see:
 - [Editing a Geological Model](#)
 - [Surfacing Options for Deposits and Erosions](#)

- [Surfacing Options for Intrusions](#)
- [Surfacing Options for Veins](#)
- [Surfacing Options for Faults](#)
- [Changing Fault Inputs](#)
- For editable interpolated meshes and offset meshes (🌐), **Snap to data** can be set by double-clicking on the mesh and changing the settings in the **General** tab. See [Refining an Interpolated Mesh](#) and [Offset Meshes](#) for more information.

Global Trends

In Leapfrog Geo, many surfaces can be adjusted by applying a trend to the surface. To do this, add the surface you wish to adjust to the scene so that it can be used in setting the trend. Double-click on the surface in the project tree and select the **Trend** tab. Here, the **Trend** tab is displayed for a contact surface:

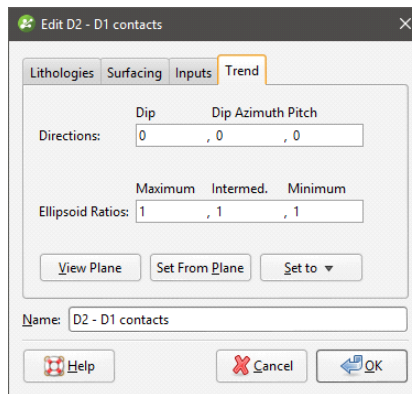

Often the easiest way to apply a trend is to click on the **Draw plane line** button (🌐) and draw a plane line in the scene in the direction in which you wish to adjust the surface. You may need to rotate the scene to see the plane properly.

The **Ellipsoid Ratios** determine the relative shape and strength of the ellipsoids in the scene, where:

- The **Maximum** value is the relative strength in the direction of the green line on the moving plane.
- The **Intermed.** value is the relative strength in the direction perpendicular to the green line on the moving plane.
- The **Minimum** value is the relative strength in the direction orthogonal to the plane.

Once you have adjusted the plane to represent the trend you wish to use, click the **Set From Plane** button to copy the moving plane settings.

The **Set to** list contains a number of different options Leapfrog Geo has generated based on the data used in the project. **Isotropic** is the default option used when the surface was created. Settings made to other surfaces in the project will also be listed, which makes it easy to apply the same settings to many surfaces.

Click **OK** to apply the changes.

How the moving plane can be used to adjust a surface in this manner is illustrated by the following intrusive contact surface:

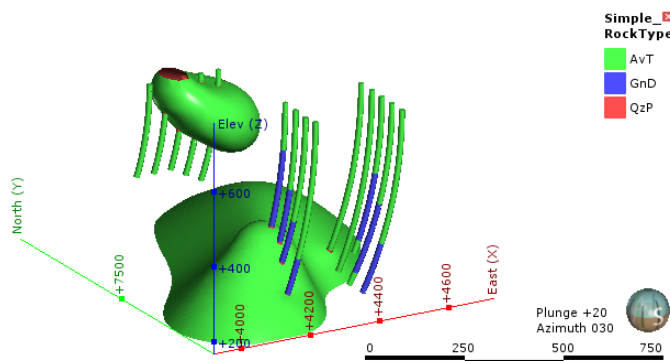

The intrusion surface has two bodies that are not connected, and we can apply a trend to connect the two parts. Here, the intrusion surface has been hidden in the scene and the scene rotated to line up the QzP segments. A plane line can then be drawn through the QzP segments:

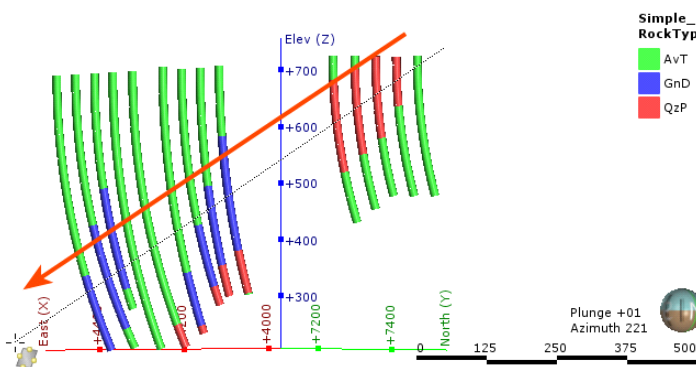

Using the plane settings to adjust the surface results in the two parts of the intrusion joining up:

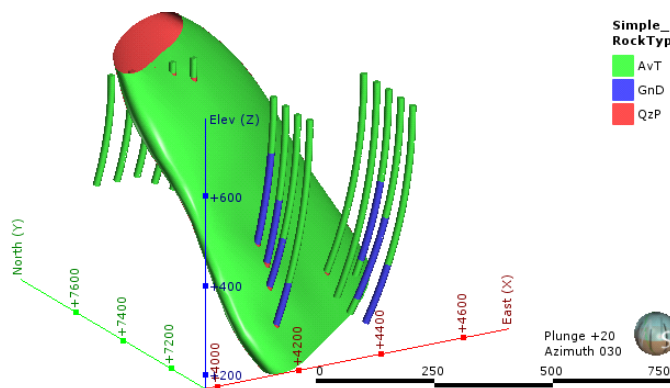

Structural Trends

Structural trends create a flat ellipsoid anisotropy that varies in direction with its inputs. This topic describes working with structural trends. It is divided into:

- [Creating a Structural Trend](#)
- [Displaying a Structural Trend](#)
- [Applying a Structural Trend](#)

Creating a Structural Trend

To create a new structural trend, right-click on the **Structural Trends** folder (in the **Structural Modelling** folder) and select **New Structural Trend**. The **Structural Trend** window will appear:

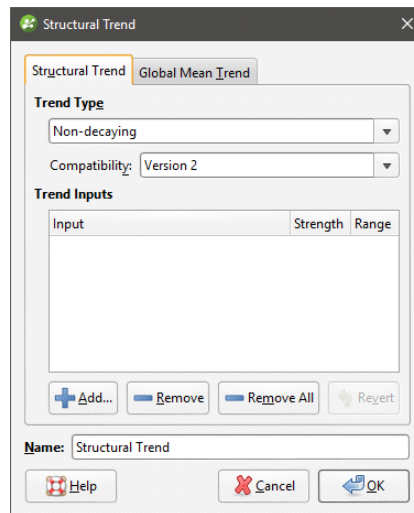

Structural trends can be created from surfaces and from structural data. Click **Add** to select from the suitable inputs available in the project. The list of inputs will be displayed:

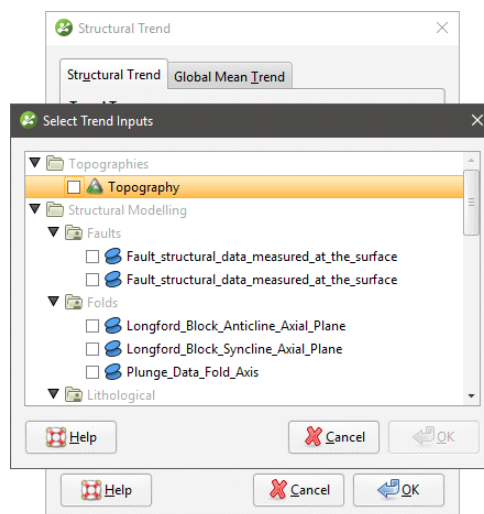

Tick the box for each input required, then click **OK**. The selected inputs will be added to the **Structural Trend** window:

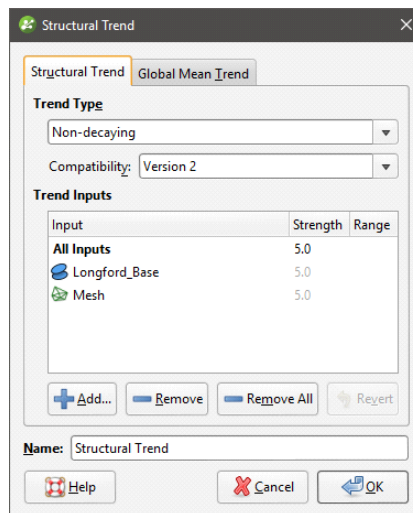

The **Strength** parameter determines the shape of the ellipsoid, and the **Range** parameter indicates how far the influence of this mesh reaches. If the **Trend Type** is **Non-decaying**, the distance from the mesh no longer affects the anisotropy and the **Range** value cannot be set. Trends that are **Strongest along meshes** or **Blending** can include a global trend. To set this, click on the **Global Mean Trend** tab.

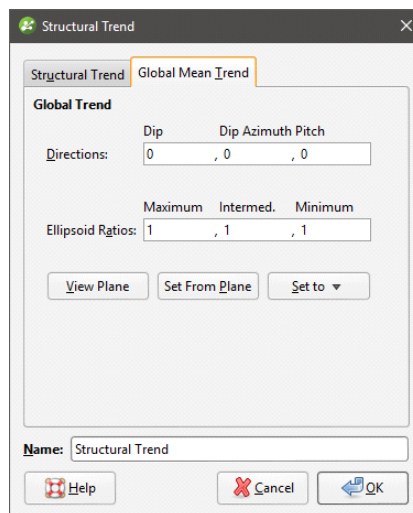

You can enter the trend manually or add the moving plane to the scene and set the trend using the moving plane, as described in [Global Trends](#).

The **Compatibility** setting determines the algorithm used to create the structural trend. Structural trends created in earlier versions of Leapfrog Geo (before 2.2) used the Version 1 algorithm. When these structural trends are upgraded, you can change them so they use Version 2, which may be desirable if adding more data to the trend results in significant changes in areas that are not close to new data.

Enter a **Name** for the trend and click **OK**. The new trend will appear under the **Structural Trends** folder.

Displaying a Structural Trend

When displayed in the scene, the trend is shown using disks placed on a regular grid:

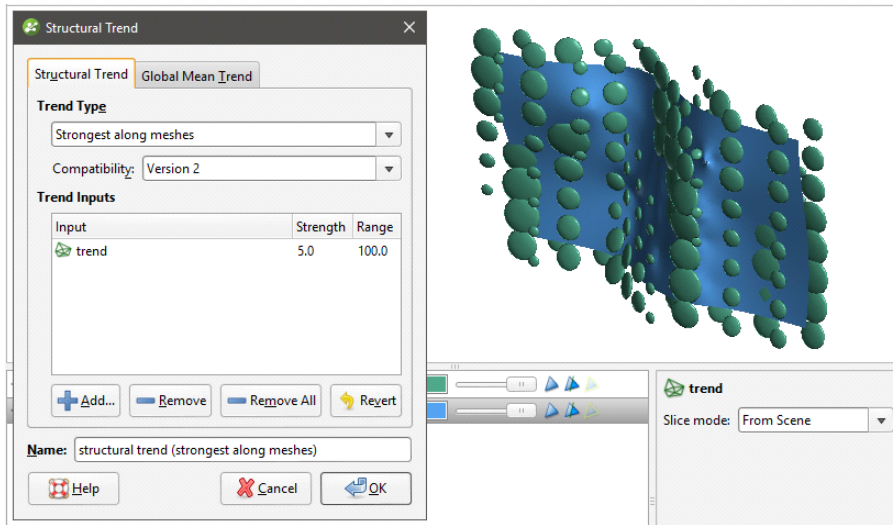

The orientation of the disk gives the direction of the anisotropy. The size of a disk is proportional to the anisotropy strength. Where there are no disks (or the size is very small) the trend is isotropic.

If the **Trend Type** is set to **Non-decaying**, the distance from the mesh no longer affects the anisotropy and all disks have the same size:

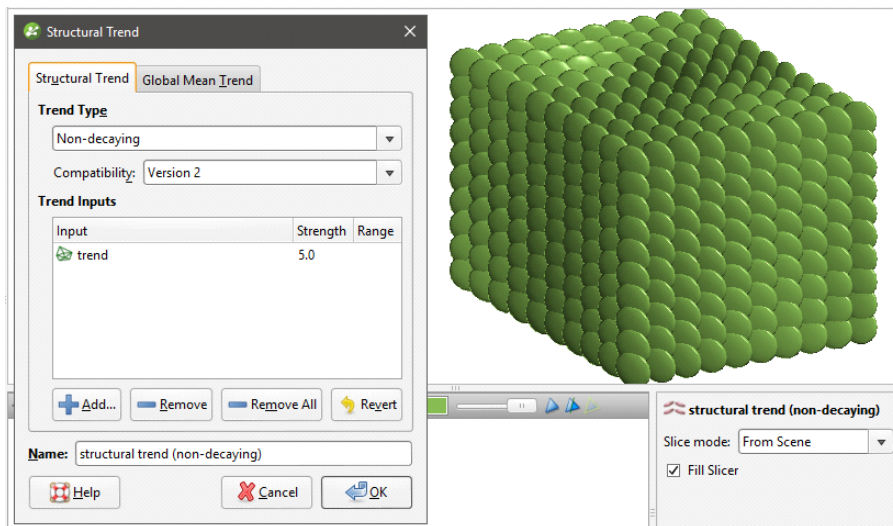

The **Blending** option requires multiple meshes and blends them according to their individual strength settings. A trend with higher strength makes a stronger impact on the blending. The blended trend is of decaying-type, and its strength weakens further away from the mesh.

Applying a Structural Trend

To apply a structural trend to an interpolated editable mesh or an interpolant, double-click on the object in the project tree and click on the **Trend** tab:

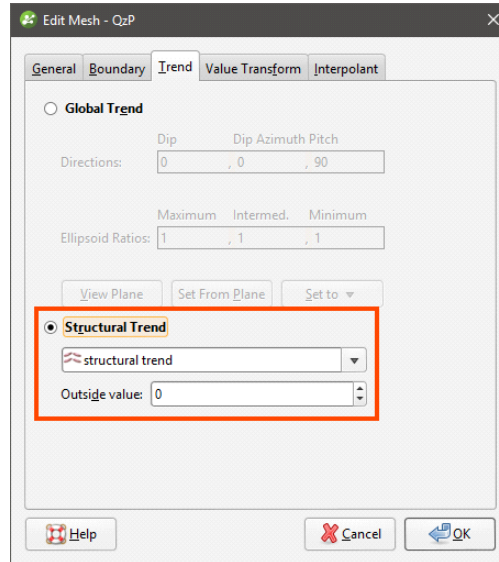

To apply a structural trend to an intrusion contact surface, enable **Show additional surfacing options** in the **Surfacing** tab, then click on the **Trend** tab.

Click on **Structural Trend**, then select the required trend from the list. Click **OK** to apply the trend to the surface.

When a structural trend is applied, surfaces may appear distorted further away from the data:

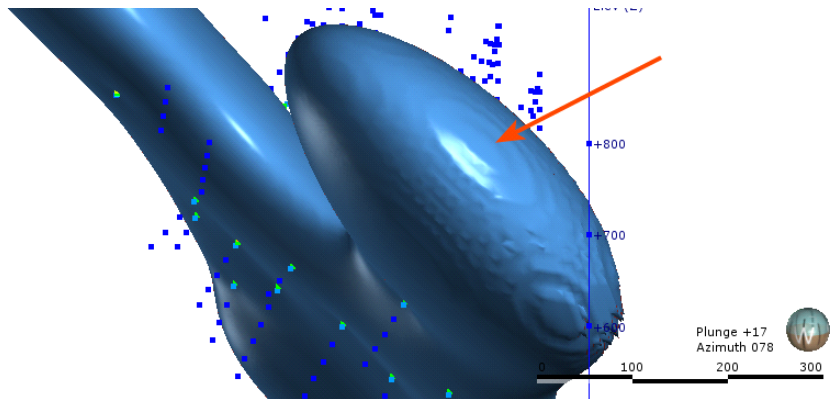

If this is the case, experiment with the **Outside value** setting. The **Outside value** is the long-range mean value of the data. Setting a value of -1 for intrusions (where the positive values are on the inside) and +1 for other surfaces will result in a smoother surface in most cases. For example, here, the **Outside value** has been set to -1 for this intrusion, resulting in a much smoother surface:

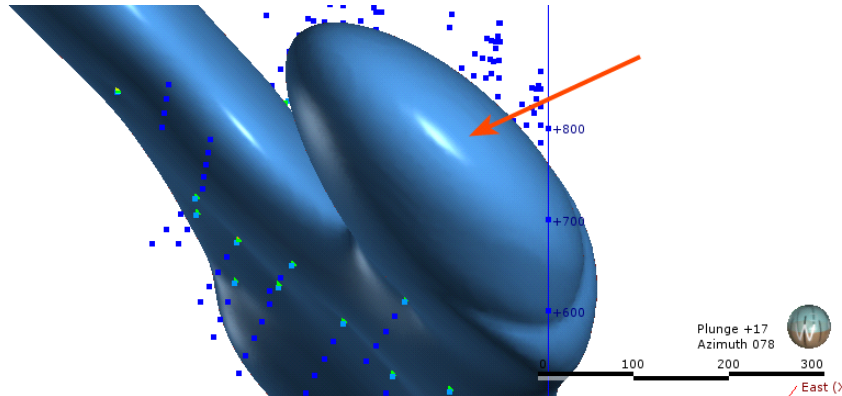

Editing Surfaces with Polylines

In Leapfrog Geo, many surfaces can be edited using polylines, including contact surfaces, geological model extents and editable meshes.

To edit a surface with a polyline, it is a good idea to first add the object you wish to edit to the scene and draw a slice across the scene where you plan to edit the surface. Next, right-click on the surface in the project tree and select **Edit > With Polyline**.

The drawing toolbar will appear for the type of polyline selected and a new polyline will be added to the scene. Draw the polyline and adjust it as described in [Drawing in the Scene](#), then click the **Save** button (📁) to view the effect of the polyline on the surface. To remove the polyline from the surface, expand the surface in the project tree. Right-click on the polyline object and select **Remove**.

In cases where you have existing polyline edits (control points), you can import them and add them to the surface. To do this, import the polylines to the **Polylines** folder, then add them to the surface by right-clicking on the surface and selecting **Add > Polyline**.

How a polyline can be used to edit a surface can be illustrated by the following surface, where a small volume is disconnected from the main surface:

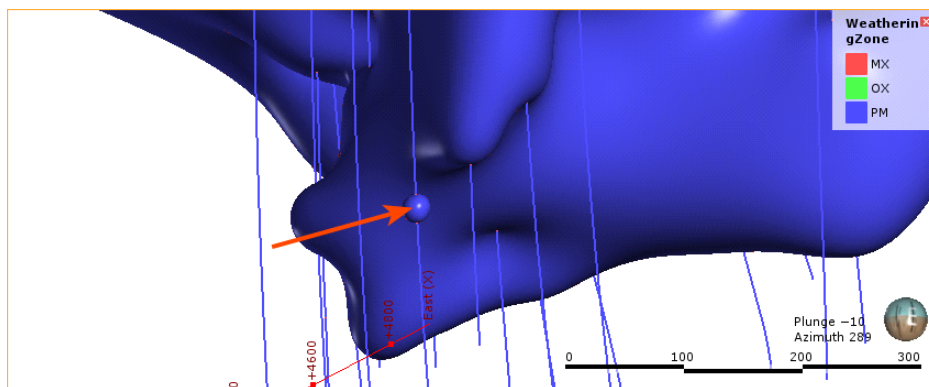

First, a slice is drawn through the surface where it will be edited:

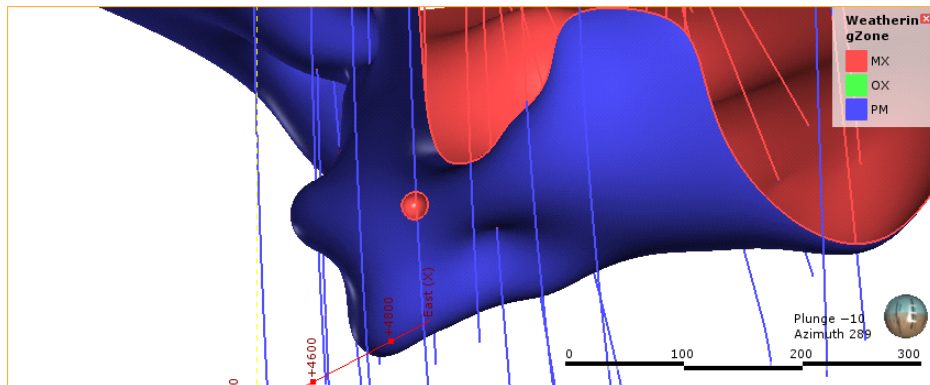

Next, a polyline is created, using two lines to represent contacts that link up the surfaces:

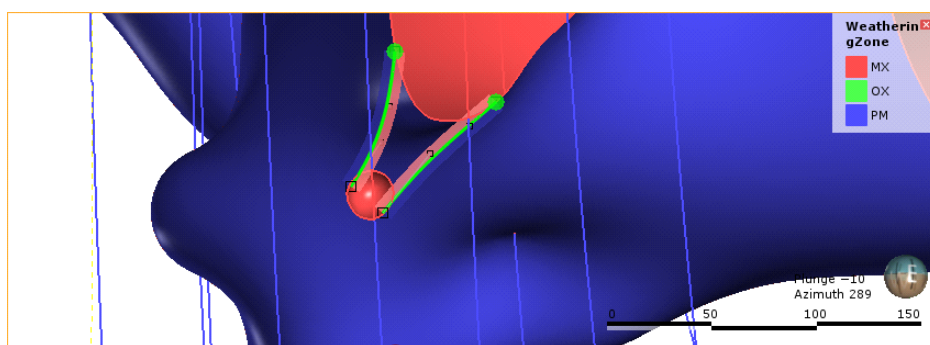

When the polyline edits are saved, the surface is updated to reflect the edits:

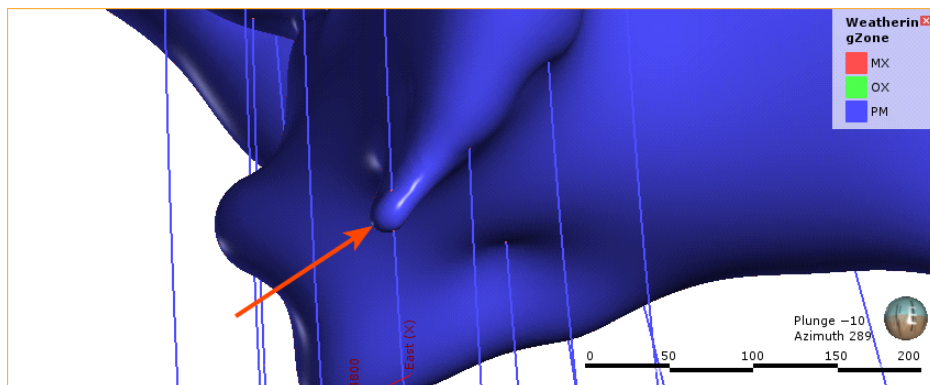

It is best to keep polyline edits to a minimum, as small edits can have significant effects on the shapes of surfaces.

If editing a surface with a polyline results in a distorted surface, use the surface and normal ribbons to check the orientation of the polyline and its segments. See [Tangents and Ribbons](#) for more information.

When you save the polyline, the object will be updated to reflect the additional points. The polyline will be added to the project tree as part of the object that was edited. You can edit the polyline by double-clicking on it or by right-clicking and selecting **Edit Polyline**.

Editing Surfaces with Structural Data

In Leapfrog Geo, many surfaces can be edited using planar structural data points drawn in the scene. Surfaces that can be edited in this way include contact surfaces, model extents and interpolated editable meshes. There are two ways to do this:

- If you have a structural data table created in or imported into Leapfrog Geo that you want to use to adjust the surface, right-click on the surface in the project tree and select **Add > Structural Data**. You will be prompted to select from the structural data tables available in the project.
- If you want to create structural data points to use to adjust the surface, right-click on the surface in the project tree and select **Edit > With Structural Data**.

To edit a surface with structural data using the second option, it is a good idea to first add the object you wish to edit to the scene. Next, right-click on the surface in the project tree and select the **Edit > With Structural Data** option.

The structural data toolbar will appear and a new structural data object will be added to the scene. Draw the structural data points and adjust them as described in [Creating New Planar Structural Data Tables](#), then click the **Save** button (📁) to view the effect on the surface. Structural data tables created in this way cannot be used by other objects in the project until the table has been shared. To do this, right-click on the table in the project tree and select **Share**. The structural data table will be saved to the **Structural Modelling** folder.

To remove the structural data from the surface, expand the surface in the project tree. Right-click on the structural data object and select **Remove**.

Non-Editable Meshes

Leapfrog Geo provides you with several tools for creating non-editable meshes:

- [Mesh from the Moving Plane](#)
- [Combining Meshes](#)
- [Clipping a Volume](#)
- [Clipping a Mesh](#)
- [Extracting Mesh Parts](#)

These tools produce non-editable meshes (🗑️).

Mesh from the Moving Plane

When a vertical wall, flat fault plane or other flat geological surface is required, the moving plane can be used to create a simple mesh.

To create a new mesh from the moving plane, first display the plane in the scene by clicking on the **Show Plane** button (📄). Use the controls in the scene to position the plane, then right-click on the **Meshes** folder and select **Mesh From Moving Plane**. The **Mesh From Plane** window will appear:

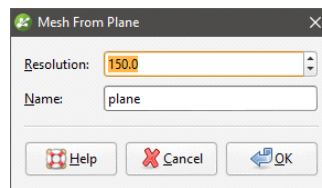

Set the **Resolution** for the mesh, enter a name and click **OK**. The new mesh will appear in the **Meshes** folder.

See [Surface Resolution in Leapfrog Geo](#) for more information on the resolution setting.

Combining Meshes

To create a new mesh from two existing closed meshes, right-click on the **Meshes** folder and select **Mesh Operations > Boolean Volume**. The **Boolean Volume** window will appear:

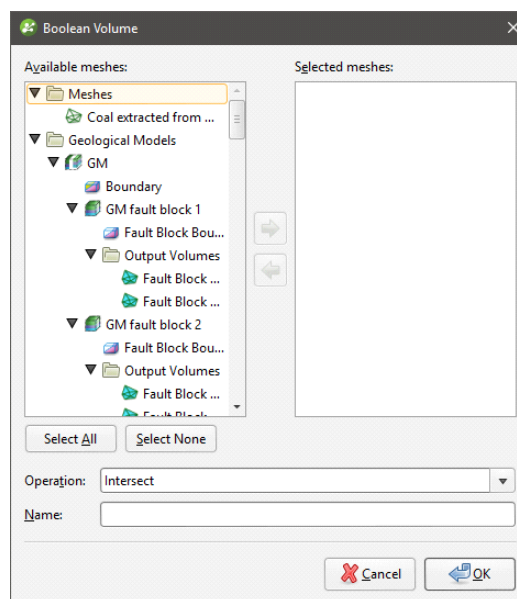

The **Available** list shows all closed meshes available in the project. Select a mesh by double-clicking on it or by clicking on it, then on the arrow.

The **Operation** type can be **Intersect** or **Union**.

Click **OK** to save the new mesh, which will appear in the **Meshes** folder. To edit the mesh, double-click on it. The **Boolean Volume** window will appear.

When any of the meshes used to create the volume is modified, the volume will be updated.

Clipping a Volume

To clip a closed mesh using another mesh, right-click on the **Meshes** folder and select **Mesh Operations > Clip Volume**. The **Clip Volume** window will appear. Select the meshes you wish to use and whether to retain the inside or outside of the clipped mesh.

Click **OK** to save the new mesh, which will appear in the **Meshes** folder. To edit the mesh, double-click on it.

When either of the meshes used to create the clipped volume is modified, the clipped volume will also be updated.

Clipping a Mesh

This option creates a new mesh that consists of the parts of a **Clip** mesh that are inside, outside or overlap with the **Using** mesh. To clip one mesh using another mesh or boundary in this manner, right-click on the **Meshes** folder and select **Mesh Operations > Clip Mesh**. The **Clip Mesh** window will appear:

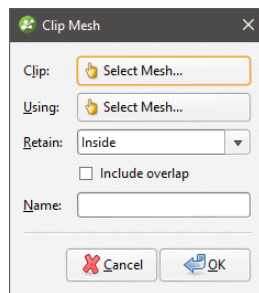

Select the meshes to use, then choose whether to retain the inside or the outside of the clipped mesh. Tick the **Include overlap** box to include the overlap between the two meshes as part of the new mesh.

Click **OK** to save the new mesh, which will appear in the **Meshes** folder. To edit the mesh, double-click on it. The **Clip Mesh** window will appear.

When either of the meshes used to create the clipped mesh is modified, the clipped mesh will be updated.

Extracting Mesh Parts

To extract the triangles from a mesh and create a new mesh, right-click on the surface and select **Extract Mesh Parts**. The **Extract Mesh Parts** window will appear:

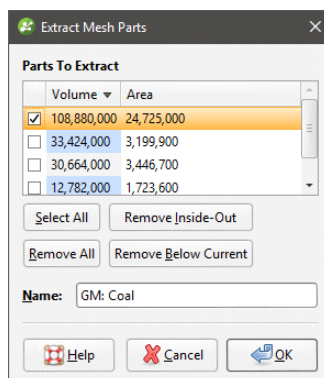

The **Extract clipped mesh** option is only available for meshes that are clipped to a boundary. The largest part is initially selected. You can sort the mesh parts by **Volume** or by **Area** by clicking the heading of the respective column. Other options are:

- Select all parts by clicking the **Select All** button. To de-select all parts click the **Remove All** button.
- Inside-out parts have negative volume. To remove them, click the **Remove Inside-Out** button.
- To remove parts smaller than a given size, first click the **Select All** button. Select the last item you want to keep and click the **Remove Below Current** button.

Click **OK** to save the new mesh, which will appear in the **Meshes** folder. The mesh generated is a non-editable mesh (🔒).

Meshes created in this way are not connected to the mesh they were created from. Changes to the original mesh will not be reflected in the selected parts.

If the quality of the mesh produced is not acceptable, clip the mesh as described in [Clipping a Mesh](#).

Interpolated Meshes

An interpolated mesh is a type of editable mesh (🌐). An interpolated mesh uses FastRBF to fit and interpolate surface data. The FastRBF is useful for creating meshes from sparse datasets or when data has large areas where there are no points. Interpolated meshes can be created from points data, GIS data, polylines, structural data and values objects.

Interpolated meshes can be edited by adding more data to the mesh and changing settings.

This topic describes creating and working with interpolated meshes. It is divided into:

- [Creating an Interpolated Mesh](#)
- [Refining an Interpolated Mesh](#)
 - [Surface Resolution Settings](#)
 - [Snap Settings](#)
 - [Other Options](#)

Creating an Interpolated Mesh

The steps for creating a mesh from data in the project are similar, regardless of the data used to create the mesh. The exception is creating an offset mesh, which requires additional parameters. See [Offset Meshes](#) for more information.

To create an interpolated mesh from data in the project, right-click on the **Meshes** folder and select from the **New Mesh** options.

Here, a new mesh is being created from points:

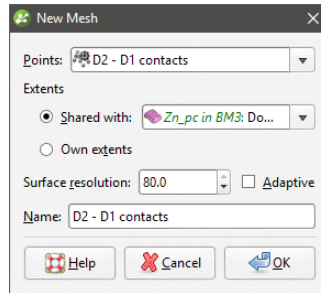

Select the required object from the list.

When defining the mesh's extents, you can set the extents to be independent of other objects in the project (**Own extents**) or you can use the extents of another object (**Shared with**). When you select the **Shared with** option, the mesh will be updated when the extents object it shares is updated.

Leapfrog Geo automatically sets the surface resolution based on the data available in the project. You can experiment with the surface resolution and adaptive settings once you have created the mesh. See [Surface Resolution in Leapfrog Geo](#) for more information on the effects of these settings.

Enter a name for the new mesh and click **OK**.

If you are creating the mesh from a polyline, you will be prompted to select an existing polyline or draw a new one. If you draw a new polyline, it will not be able to be used elsewhere in the project unless it has been shared. To share the polyline, expand the mesh in the project tree, right-click on the polyline and select **Share**.

The new mesh will appear in the **Meshes** folder. Expand the mesh in the project tree to see how it was made. As further refinements are made to the mesh, that information will also be added to the mesh in the project tree.

Refining an Interpolated Mesh

Editable interpolated meshes (🔗) can be refined by adding data, as described in [Adding Data to Surfaces](#). The options available depend on how the mesh was created.

To add data to an editable mesh, right-click on it and select one of the options from the **Add** menu. A list of objects available in the project will be displayed. Select the required object and click **OK**. The mesh will be updated and the object used to modify it will appear under it in the project tree.

You can also refine editable interpolated meshes by changing the trend, transforming values, adjusting the interpolant and changing the boundary. To do this, double-click on the mesh. The **Edit Mesh** window will be opened:

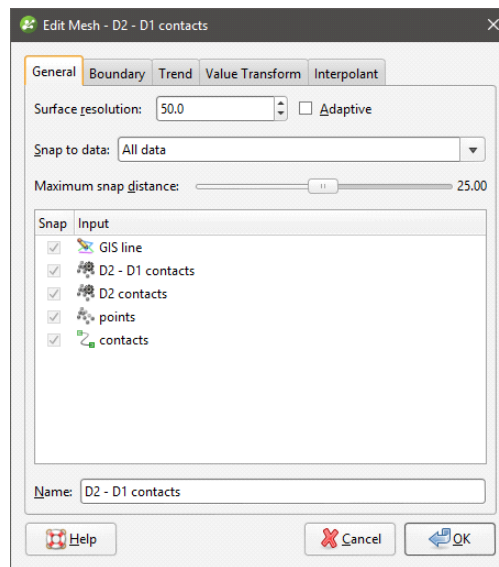

See [Offset Meshes](#) for the options available for meshes from offset points.

Surface Resolution Settings

See [Surface Resolution in Leapfrog Geo](#) for more information on the **Surface resolution** settings in the **General** tab.

Snap Settings

The mesh can be set to snap to the data objects used to create it. There are four options:

- **Off.** The mesh does not snap to the data.
- **All data.** The mesh snaps to data within the **Maximum snap distance**.
- **Drilling only.** The mesh snaps only to drillhole data and data objects derived from drillhole data within the **Maximum snap distance** but not to other data. For example, the mesh will honour points data derived from drillhole data, but not points data imported into the **Points** folder.
- **Custom.** The mesh snaps to selected data objects within the **Maximum snap distance**.

Take care in enabling snapping and in selecting what data the surface will snap to, as the more data you include, e.g. by setting a large **Maximum snap distance** or selecting **All data** for **Snap to data**, the greater the possibility that errors in the data or assumptions inherent in interpretations (e.g. polylines) will cause distortions in the meshes. If you do enable snapping, it is best to snap only to drilling data. See [Honouring Surface Contacts](#) for more information on these settings.

When **Snap to data** is set to **Custom**, you can then set whether or not **Snap** is enabled for the objects used to create the mesh, as discussed in [Honouring Surface Contacts](#). **Custom** is the most flexible options as you can select the specific data objects the mesh will or will not snap to. If you will be exporting the mesh for use in another application, you may wish to adjust the snap settings.

Data used to create the mesh will appear in the **Input** list. When you add more data to the mesh, those objects will also be listed. You can remove those additional objects by expanding the mesh in the project tree, then right-clicking on the data object and selecting **Remove**.

Other Options

In the **Boundary** tab, you can change whether the mesh boundary is independent of other objects in the project (**Own extents**) or you can use the extents of another object (**Shared with**). When you select the **Shared with** option, the mesh will be updated when the extents object it shares is updated.

Options available in other tabs are similar to those available for interpolants. See:

- [Structural Trends](#)
- [Clipping and Transforming Values for an RBF Interpolant](#)

For information on the parameters in the **Interpolants** tab, see:

- [Interpolant Functions](#)
- [The Spheroidal Interpolant Function](#)
- [The Linear Interpolant Function](#)

Offset Meshes

You can create a new interpolated mesh by offsetting an existing mesh with any points object in the project. To do this, first ensure the points and mesh you wish to use are already in the project. Next, right-click on the **Meshes** folder and select **New Mesh > From Offset Points**. In the window that appears, select the **Mesh** and **Points** to use:

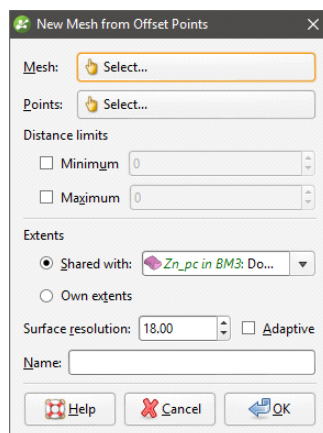

When the mesh is created, it will automatically snap to the points, and points outside the **Distance Limits** will be ignored. These settings can be changed once the mesh has been created.

An offset mesh may be distorted if points used to offset the mesh lie too far outside the mesh extents. If this occurs, set a **Maximum** distance to exclude points far away from the mesh extents.

Enter a name for the new mesh and click **OK**. The new mesh will appear in the **Meshes** folder. To edit the mesh, double-click on it. The **Edit Offset Mesh** window will appear:

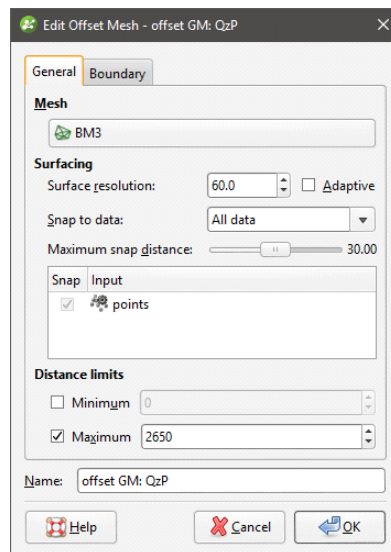

The mesh can be set to snap to the data objects used to create it. There are four options:

- **Off**. The mesh does not snap to the data.
- **All data**. The mesh snaps to data within the **Maximum snap distance**.
- **Drilling only**. The mesh snaps only to drillhole data and data objects derived from drillhole data within the **Maximum snap distance** but not to other data. For example, the mesh will honour points data derived from drillhole data, but not points data imported into the **Points** folder.
- **Custom**. The mesh snaps to selected data objects within the **Maximum snap distance**.

Take care in enabling snapping and in selecting what data the surface will snap to, as the more data you include, e.g. by setting a large **Maximum snap distance** or selecting **All data** for **Snap to data**, the greater the possibility that errors in the data or assumptions inherent in interpretations (e.g. polylines) will cause distortions in the meshes. If you do enable snapping, it is best to snap only to drilling data. See [Honouring Surface Contacts](#) for more information on these settings.

When **Snap to data** is set to **Custom**, you can then set whether or not **Snap** is enabled for the objects used to create the mesh, as discussed in [Honouring Surface Contacts](#). **Custom** is the most flexible options as you can select the specific data objects the mesh will or will not snap to. If you will be exporting the mesh for use in another application, you may wish to adjust the snap settings.

Data used to create the mesh will appear in the **Input** list. When you add more data to the mesh, those objects will also be listed. You can remove those additional objects by expanding the mesh in the project tree, then right-clicking on the data object and selecting **Remove**.

You can modify an offset mesh by adding data, as described in [Refining an Interpolated Mesh](#).

It is not possible to add structural data or polylines with orientation information to an offset mesh. If you edit an offset mesh with a polyline, your options for editing the polyline will be limited.

You can also edit the mesh's boundary, but you cannot apply a trend, clip and transform values or adjust the interpolant as you can for other interpolated editable meshes.

Triangulated Meshes

A triangulated mesh is a type of editable mesh (🌐). A triangulated mesh uses Delaunay triangulation to create the mesh and can handle more points than an interpolated mesh. Triangulated meshes can be created from points data, GIS data and polylines. Large datasets representing horizontal surfaces can be used to create a triangulated mesh.

The steps for creating a mesh from data in the project are similar, regardless of the data used to create the mesh. To create a triangulated mesh from data in the project, right-click on the **Meshes** folder and select from the **New Triangulated Mesh** options.

Here, a new triangulated mesh is being created from points:

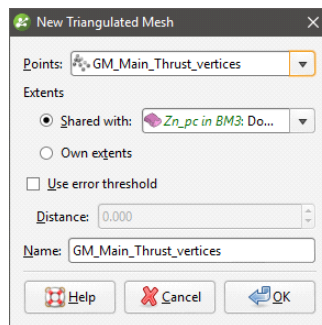

Select the required object from the list.

When defining the mesh's extents, you can set the extents to be independent of other objects in the project (**Own extents**) or you can use the extents of another object (**Shared with**). When you select the **Shared with** option, the mesh will be updated when the extents object it shares is updated.

The **Use error threshold** setting lets you exclude data points that fall within the threshold. This can be useful if you are using a large dataset and you require a more coarse surface that omits some data. When **Use error threshold** is disabled, the mesh will follow all the data.

Here, a mesh created from points has the **Use error threshold** disabled. The mesh follows all the points:

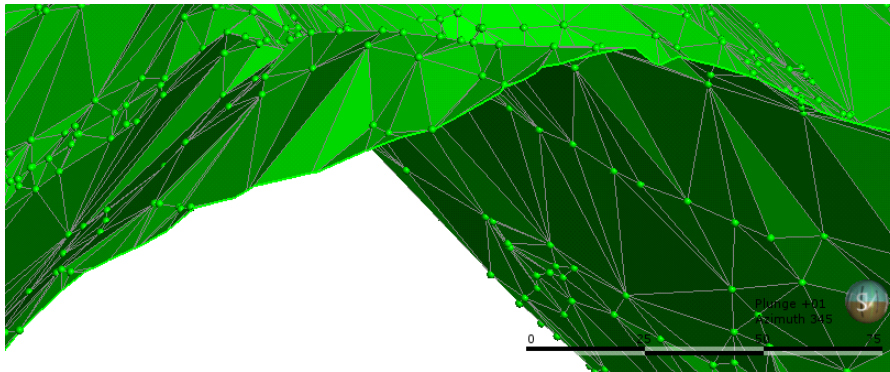

Here, a mesh has been created with the **Distance** set to 20. The mesh ignores points that fall outside the threshold:

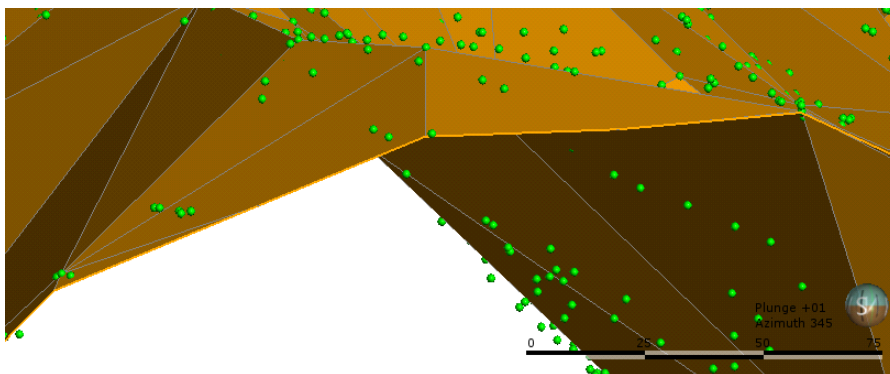

You will be able to change the **Use error threshold** setting once the mesh has been created. Enter a name for the new mesh and click **OK**.

If you are creating the mesh from a polyline, you will be prompted to select an existing polyline or draw a new one. If you draw a new polyline, it will not be able to be used elsewhere in the project unless it has been shared. To share the polyline, expand the mesh in the project tree, right-click on the polyline and select **Share**.

The new mesh will appear in the **Meshes** folder and you can edit its settings by double-clicking on it.

To add data to a triangulated mesh, right-click on it and select one of the options from the **Add** menu. A list of objects available in the project will be displayed. Select the required object and click **OK**. The mesh will be updated and the object used to modify it will appear under it in the project tree.

It is not possible to add structural data or polylines with orientation information to a triangulated mesh. If you edit a triangulated mesh with a polyline, your options for editing the polyline will be limited.

Elevation Grids

Leapfrog Geo imports and exports elevation grids in common formats.

Importing an Elevation Grid

Elevation grid formats Leapfrog Geo supports include:

- Arc/Info ASCII Grid Files (*.asc, *.txt)
- Arc/Info Binary Grid Files (*.adf)
- Digital Elevation Model Files (*.dem)
- Surfer ASCII or Binary Grid Files (*.grd)
- SRTM Files (*.hgt)
- ESRI.hdr Labelled Image Files (*.img, *.bil)
- GeoTIFF Image Files (*.tiff, *.tif)

There are two ways to import an elevation grid:

- Import the grid to the **Meshes** folder. Right-click on the **Meshes** folder and select **Import Elevation Grid**.
- Import the grid as part of creating a topography. Right-click on the **Topographies** folder and select **New Topography > Import Elevation Grid**.

Navigate to the folder that contains the elevation grid file and open the file. The **Import Elevation Grid** window will be displayed:

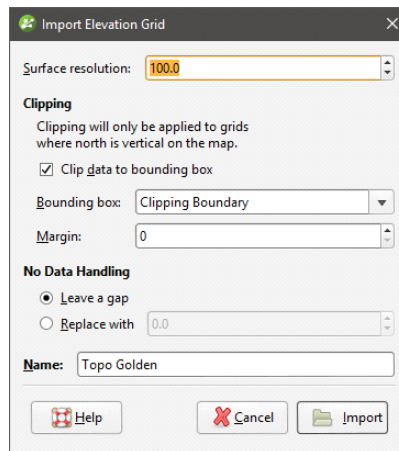

Leapfrog Geo automatically sets a **Surface resolution** based on the information in the file, but you can change the value if you wish. A lower value will produce more detail, but calculations will take longer. See [Surface Resolution in Leapfrog Geo](#) for more information.

When importing an elevation grid, note that the resolution cannot be changed once the file has been imported.

Data is automatically clipped to the clipping boundary, but you can change how the data is filtered to suit any bounding box that exists in the project. If you do not wish to clip the data, untick **Clip data to bounding box**.

The **Margin** value determines how far outside the selected **Bounding box** the elevation grid will extend.

The **No Data Handling** option determines whether NoData values are displayed as gaps or at a fixed elevation setting.

Click **Import**. If you are creating a new topography, you will then be prompted to enter a name for it and click **OK**.

The elevation grid will be added to the **Meshes** folder. If you imported the grid as part of creating a topography, a hyperlink to the grid in the **Meshes** folder will appear as part of the defined topography.

Exporting an Elevation Grid

For any mesh in a project, you can export an elevation grid for use in other software. Formats Leapfrog Geo can export are:

- ARC/Info ASCII Grid (*.asc)
- ESRI.hdr Labelled (*.bil)
- ENVI Raster Image (*.img)
- Surfer ASCII Grid (*.grd)

If you have the Maptek Link module, you can also export an elevation grid in VULCAN v7 .00g format. Contact Customer Support as described in [Getting Support](#) for more information about licensing this module.

To export an elevation grid, right-click on the mesh and select **Export Elevation Grid**. The **Export Grid** window will appear:

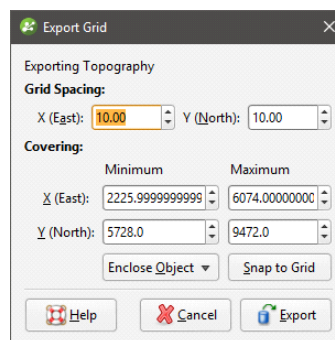

The **Snap to Grid** option changes the extents of the exported grid so that they coincide with the elevation grid spacing.

Enter the information required, then click **Export** to enter a filename and choose a location and format for the file.

Thickness Grids

For any mesh in a project, you can export a grid made up of the area between two surfaces. Formats Leapfrog Geo can export are:

- ARC/Info ASCII Grid (*.asc)
- ESRI.hdr Labelled (*.bil)
- ENVI Raster Image (*.img)
- Surfer ASCII Grid (*.grd)

To export a thickness grid, right-click on the mesh and select **Export Thickness Grid**. The **Export Thickness Grid** window will appear:

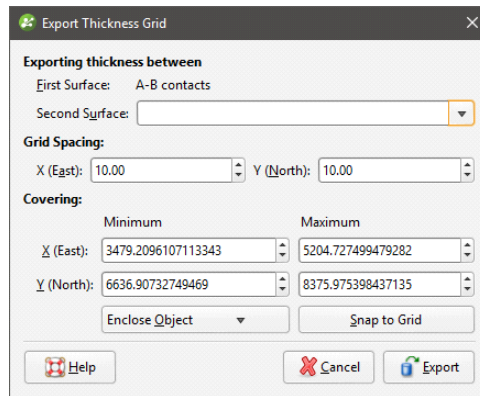

Select the surfaces required from the lists.

Enter the information required, then click **Export**. You will be prompted for a filename and location.

Polylines

Leapfrog Geo imports many common polyline formats and also has tools for drawing and exporting polylines. This topic describes:

- [Creating Polylines](#)
- [Displaying Polylines](#)
- [Sharing and Unsharing Polylines](#)
- [Importing Polylines](#)
- [Reloading Polylines](#)
- [Exporting Polylines](#)

See [Drawing in the Scene](#) for information on drawing and editing polylines.

Creating Polylines

There are three ways to create polylines in Leapfrog Geo:

- Create a new polyline using the **Polylines** folder. These polylines are stored in the **Polylines** folder.
- Create a new polyline as part of working with another tool. For example, a polyline can be drawn to create a lateral extent in a geological model. These polylines are stored in the tool used to create them and cannot be used elsewhere in the project unless they have been shared. To share a polyline, right-click on it and select **Share**. The polyline will be moved to the **Polylines** folder and can be used elsewhere in the project.
- Create a new polyline from a GIS line. To do this, right-click on the GIS lines object (🗺️ or 📷) in the **GIS Data, Maps and Photos** folder and select **Extract Polyline**. The new polyline object will appear in the **Polylines** folder. It is not linked to the original GIS lines object.

See [Drawing in the Scene](#) for information on drawing and editing polylines.

Displaying Polylines

When polylines are displayed in the scene, you can control the colour of the positive and negative surfaces of the line and of the line itself. In this example, the positive side of the polyline is red, the negative side is blue and the polyline itself is green:

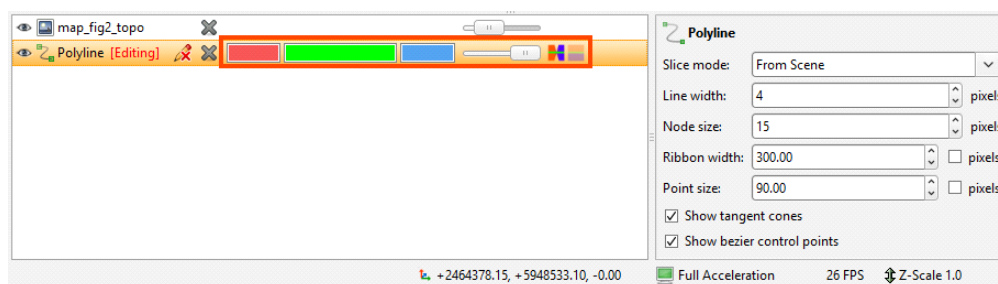

For contact surfaces, the colour of the positive and negative sides of a ribbon will be determined by the lithologies or categories assigned to either side of the surface.

With the **Node size** and **Point size** controls in the properties panel, you can change the size of nodes and points in the scene to make working with the polyline easier.

Polylines have a **Surface ribbon** (🚩) and **Normal ribbon** (🚩) to help you to determine the orientation of the polyline in the scene. The surface ribbon reflects the orientation of the polyline and the normal ribbon is perpendicular to the surface ribbon. For example, click on the **Surface ribbon** button (🚩) to determine which side of the polyline is positive (red) and which side is negative (blue):

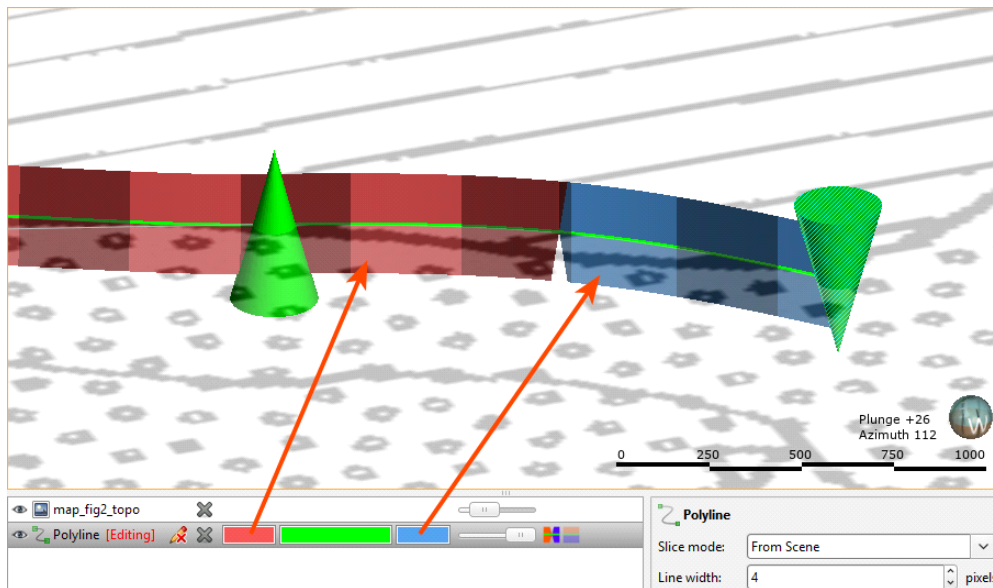

If you are having trouble seeing the ribbons, you can change their size using the **Ribbon width** control in the properties panel.

Other aspects of polyline display are useful when creating and editing polylines. See [Drawing in the Scene](#).

Sharing and Unsharing Polylines

Some polylines are created as part of working with other objects and are not available elsewhere in the project. An example of this is a polyline drawn as part of creating a model boundary. To share the polyline, right-click on the object in the project tree and click **Share**. The shared polyline will be copied to the relevant location in the project tree and a hyperlink added to the object it was shared from.

Polylines that have been shared can be unshared by making a local copy of the polyline. To do this, right-click on the shared polyline and select **Create Local Copy**:

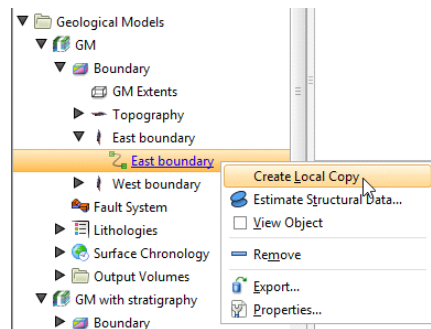

The polyline in the **Polylines** folder remains, but a local copy of it is made and the hyperlink to the **Polylines** folder copy is deleted. This means you can now work on, for example, the **Polylines** folder copy without changes to it affecting the geological model's copy.

Importing Polylines

Polyline formats Leapfrog Geo supports include:

- Datamine Polylines (*.asc)
- Surpac String Polylines (*.str)
- Gemcom Polylines (*.asc)
- Micromine Polylines (*.str, *.asc)
- MineSight Polylines (*.srg)
- Gocad Polylines (*.pl, *.ts)
- Drawing Interchange Polylines (*.dxf)
- Leapfrog Polylines (*.lfpl)
- Leapfrog Polylines (*.csv, *.txt)

There are two ways to import a polyline:

- Right-click on the **Polylines** folder and select **Import Polyline**. In the **Import Polyline** window, navigate to the location where the polyline file is saved and select it. Click **Open**.
- Drag and drop polyline files directly into Leapfrog Geo.

If the polyline file is in Leapfrog, Gocad or DXF formats, the importing will start immediately. For all other formats, the **Polyline Import** window will appear. If the polyline file is in one of the standard formats listed above, the default settings can be used. Click **Import** to finish the process. If, however, you wish to specify polyline import parameters, two pieces of information are required:

- The columns the polyline vertex coordinates are in
- How the polyline sections are separated in the file

Select the vertex coordinate columns by clicking on the heading at the top of a column and selecting one of East (X), North (Y) or Elev (Z) from the list.

When importing a file that has multiple features, you will be prompted to select which ones to import. You can also choose to:

- Import the features as separate objects. Each feature will appear in the project tree as a separate object.
- Flatten all features into one object. Leapfrog Geo will treat all features as a single object.

The polyline will be imported and added to the project tree under the **Polylines** folder.

See [Drawing in the Scene](#) for information on drawing and editing polylines.

Reloading Polylines

Reloading data is necessary when the imported data is modified externally. To reload a polyline, right-click on it in the project tree and select **Reload Data**.

Reloading a polyline overwrites any changes you have made to the polyline. Any dependent objects will be updated, which can take some time.

Select the file to be reloaded and click **Open**. The polyline will be updated, as will any dependent objects.

Exporting Polylines

Export a polyline by right-clicking on it and selecting **Export**. Leapfrog Geo exports polylines in the following formats:

- Leapfrog Polylines (*.lfpl)
- Leapfrog Polylines (*.csv)
- Drawing Interchange Polylines (*.dxf)
- Surpac String Polylines (*.str)
- Gocad Polylines (*.pl, *.ts)
- MineSight Polylines (*.srg)
- Datamine Polylines (*.asc)
- Micromine Polylines (*.str, *.asc)
- Drawing File (2013/LT2013) (*.dwg)
- Bentley Drawing Files (v8) (*.dgn)

Geochemical Data

The **Geochemistry** folder and related features are only available as part of the Geochemistry module. Contact Customer Support as described in [Getting Support](#) for more information about licensing this module.

With the **Geochemistry** folder, you can establish a live link to ioGAS and visualise geochemical data in real time. You can also transfer data between Leapfrog Geo and ioGAS, including data to which query filters have been applied.

This topic describes how to connect to ioGAS and transfer data between ioGAS and Leapfrog Geo. It is divided into:

- [Sending Data to ioGAS](#)
- [Importing ioGAS Data](#)

To connect to ioGAS, make sure ioGAS is running. Next, right-click on the **ioGAS** object in the project tree and select **Connect**:

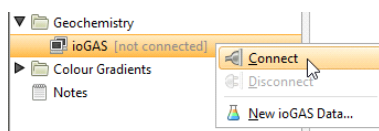

Once the connection is established, any dataset open in ioGAS will be available from the **ioGAS** object and can be displayed in the Leapfrog Geo scene window:

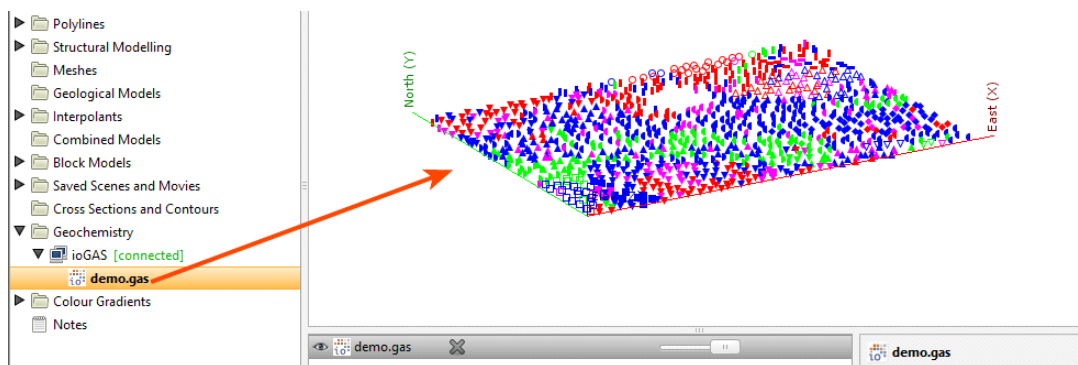

The status of the connection to ioGAS is indicated in Leapfrog Geo, and the data file open in ioGAS appears in the **Geochemistry** folder (e.g. demo.gas).

You can view the data in Leapfrog Geo by adding the ioGAS data object to the scene. When attributes are changed in ioGAS, the display will be updated in Leapfrog Geo. You can also:

- Send from and to data columns across the ioGAS link, analyse the data in ioGAS and import calculated columns as interval tables. This data can then be used for modelling in Leapfrog Geo. See [Sending Data to ioGAS](#).
- Import ioGAS data into Leapfrog Geo as points or intervals. See [Importing ioGAS Data](#).

To terminate the connection to ioGAS, right-click on the **ioGAS** object and select **Disconnect**:

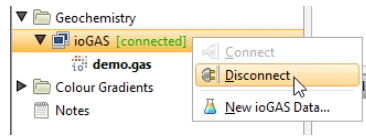

Once the connection to ioGAS is terminated, ioGAS data (*.gas) will no longer be available in Leapfrog Geo.

Sending Data to ioGAS

ioGAS version 6.1 and later recognise holeid, From and To columns sent from Leapfrog Geo. Earlier versions of ioGAS can only import point data.

To send data to ioGAS, you must first create a data object from the drillhole data in the project. This process uses data from a single interval table to create a new ioGAS object that can then be opened in ioGAS.

Note that interpretation tables cannot be used to send data to ioGAS. If you wish to send an interpretation table to ioGAS, export it from Leapfrog Geo and then import it back into the project.

There are two considerations when creating an ioGAS data object:

- Are all data columns you wish to send over the ioGAS link in the same table? Creating an ioGAS data object uses a single interval table. If the data you wish to send is in different tables, create a merged table.
- Are lithology intervals similar in length to assay data intervals or are there significant differences? The solution is to apply a majority composite to the lithology data using the interval lengths from the assay table and then create a merged table containing all the data columns you wish to send over the link.

See [Merged Drillhole Data Tables](#) and [Majority Composites](#) for more information.

To create a new ioGAS data object, right-click on the **ioGAS** object and select **New ioGAS Data**:

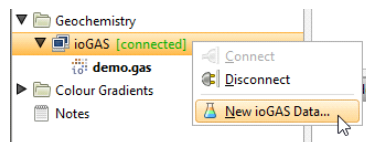

You can filter the data you send to ioGAS using any of the query filters defined in the project. Make sure the query filter you wish to use has been defined before you start creating a new data column.

In the window that appears, select the table you wish to use for the **Base table**, then select the columns to send to ioGAS. If you wish to filter the data, select the query filter required from the list.

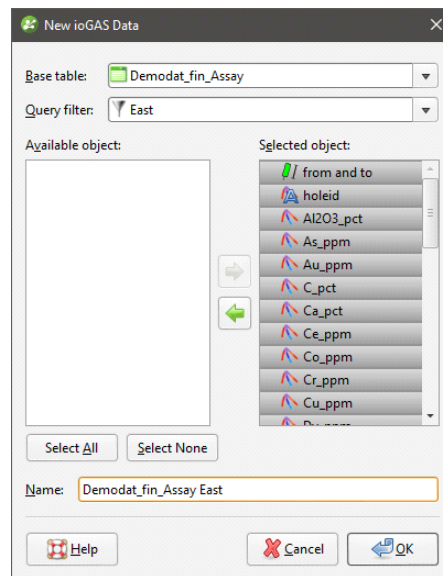

Enter a **Name** for the data column and click **OK**. The new data column will appear as part of the **ioGAS** folder:

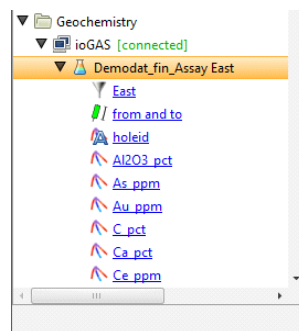

Note that any filter applied to the data is part of the new data object and will be sent to ioGAS over the link.

The next step is to open the data in ioGAS.

Opening the Data in ioGAS

Ensure that Leapfrog Geo is connected to ioGAS.

Make sure no tasks are being processed in Leapfrog Geo before opening the link from ioGAS. An error may result in ioGAS if Leapfrog Geo is processing tasks.

In ioGAS, select **File > Open Link Data**. Once the column has been opened, you can use the tools available in ioGAS to analyse the data. That the data is open in ioGAS is indicated in the project tree:

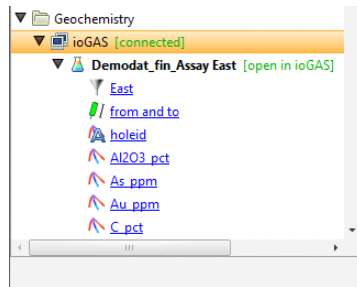

If a connection cannot be made between Leapfrog Geo and ioGAS, it could be that the **Timeout** setting in ioGAS is too low. To change this, navigate to the folder C:\Users\...\AppData\Roaming\ioGAS\userConfig. Open the file link.ini in a text editor and set the **Timeout** parameter to a higher value. The **Timeout** is in milliseconds.

If you have the data visible in the Leapfrog Geo scene, changes made will be displayed in Leapfrog Geo. Here the ioGAS attribute manager has been used to assign colours to the selected values in ten equal ranges:

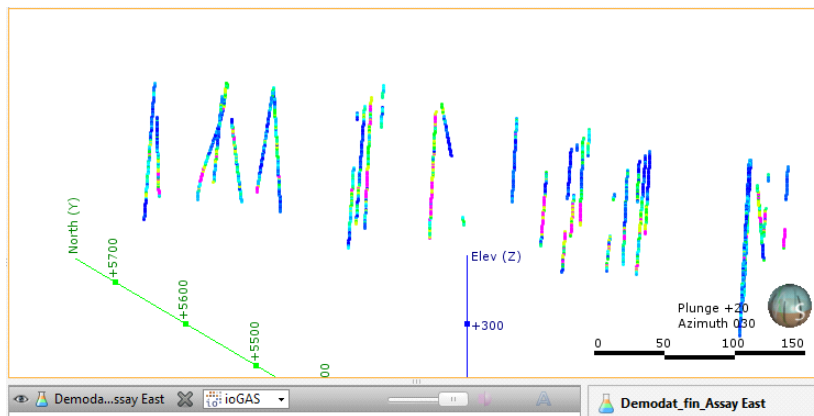

The changes to attributes are automatically updated in the Leapfrog Geo scene window as long as the link is live.

Sending a New Data Column Back to Leapfrog Geo

To save the changes and send a new data column back to Leapfrog Geo while the ioGAS link is live, select one of the **Make Variable From** options from the **Data** menu in ioGAS.

In Leapfrog Geo, the column will be added to the base interval table used to create the new lithology. Here, a column called MRV_Au (🧪) has been added to the base table:

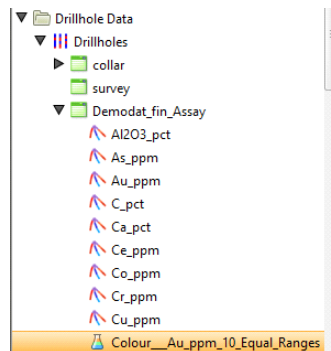

When the connection to ioGAS is terminated, the ioGAS data column will remain in the project tree as part of the **ioGAS** folder. Data columns created in ioGAS will also be available and will appear in the base interval table.

Importing ioGAS Data

When Leapfrog Geo is connected to ioGAS and a dataset is open, you can import the ioGAS data into Leapfrog Geo. There are two options:

- [Importing ioGAS Data as Points](#)
- [Importing ioGAS Data as Intervals](#)

When data is imported as points, it is added to the **Points** folder. When imported as intervals, data is added to an existing interval table or used to create a new interval table. Whichever method is selected, if the data is changed in ioGAS, it will need to be reimported.

ioGAS version 6.1 and later can send a "Filter" attribute to Leapfrog Geo. If you wish to import this attribute, set it to a category column. This imported column will appear in Leapfrog Geo as a query filter:

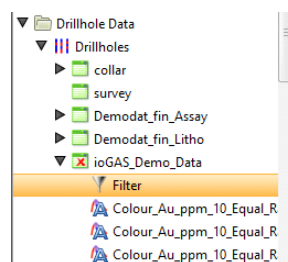

Importing ioGAS Data as Points

To import ioGAS data as points, right-click on the ioGAS data object in the project tree and select **Import as Points**:

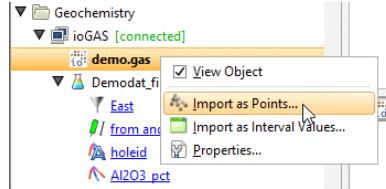

In the window that appears, select the data columns you wish to import and how they will be imported. Click **Finish** to import the data, which will appear in the **Points** folder. You can then display the points in the scene and work with them as you would any other points object. The new points object will remain in Leapfrog Geo once the connection to ioGAS is terminated.

Importing ioGAS Data as Intervals

To import ioGAS data as intervals, right-click on the ioGAS data object in the project tree and select **Import as Interval Values**. Select the table to which the imported column will be added or select the option to create a new table. Click **Import**.

- For a new table, select the columns you wish to import and enter a name for the table. Click **Finish**. The new table will be added to the **Drillholes** object.
- For adding the data to an existing table, the process is similar to that for adding a column. Select the columns to import, then click **Finish**.

Open Mining Format (OMF) Export and Import

Open Mining Format is a convenient format for exchanging data with other applications because multiple geosciences objects can be moved as a single file. Leapfrog Geo supports the export and import of Open Mining Format v0.9.

OMF export and import are available from the **Leapfrog Geo** menu:

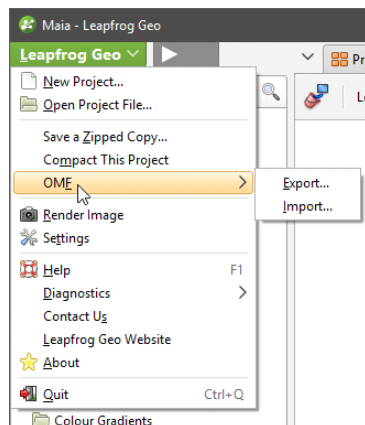

OMF Export

To export surfaces from a project in OMF format, click on the **Leapfrog Geo** menu and select **OMF > Export**. A list of objects in the project will be displayed:

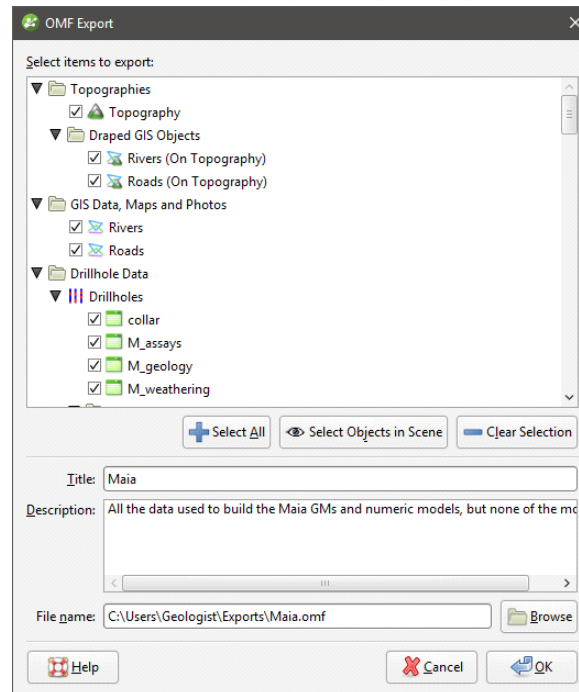

Select the objects you wish to export, then specify the file name and the folder where it will be saved. Click **OK** to export the file.

Exporting the file may take some time if you have selected a large number of objects.

OMF Import

To import data from an OMF file, click on the **Leapfrog Geo** menu and select **OMF > Import**. In the window that appears, select the file you wish to import and click **Open**. The objects in the file will be displayed:

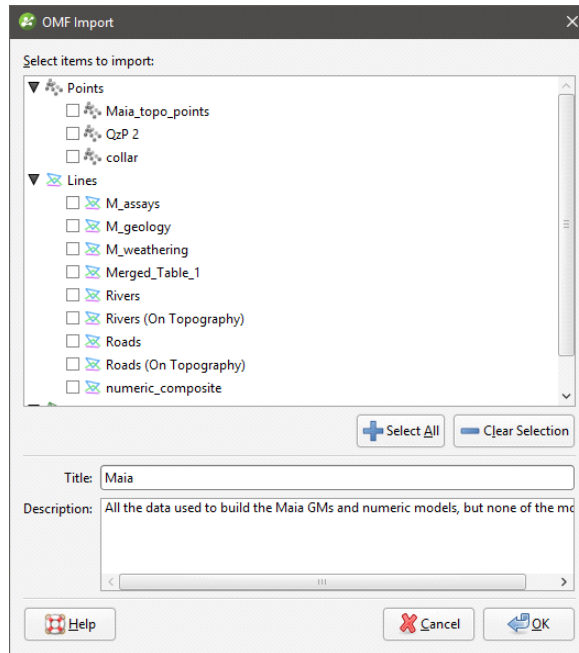

Select the objects you wish to import and click **OK**. Selected objects will be imported and added to the project tree. GIS data will be added to the **GIS Data, Maps and Photos** folder and points, meshes and block models will be added to their respective folders.

Analysing Data

Leapfrog Geo has a number of tools that help you to analyse your data.

- The most basic information about an object is contained in the object's **Properties** window, which is specific to the type of object. Right-click on the object in the project tree and select **Properties**. See [Object Properties](#) in the [The Project Tree](#) topic for more information.
- Viewing statistical information about objects helps you to analyse your data. This is described further below.
- Visualising data using the shape list and the shape properties panel is an important part of interpreting and refining data and making modelling decisions. The tools available depend on the type of object being displayed, and many objects can be displayed evaluated on other objects.
- Stereonets are useful for visualising structural data and identifying trends in 2D. Errors in categorisation of structural data can also become apparent when the data is viewed on a stereonet.
- Form interpolants are useful for visualising structural data and identifying broad trends in 3D. The form interpolant's meshes can then be used to control other surfaces in the project.
- With the drillhole correlation tool, you can view and compare selected drillholes in a 2D view. You can then create interpretation tables in which you can assign and adjust intervals and create new intervals. Interpretation tables are like any other interval table in a project and can be used to create models.
- You can plan drillholes, view prognoses for models in the project and export planned drillholes in .csv format. Leapfrog Geo can also import planned drillholes.

The rest of this topic describes the different statistics visualisations available in Leapfrog Geo.

Statistics

The statistics options available in Leapfrog Geo depend on the type of object. Common statistics visualisations are described below:

- [Table of Statistics](#)
- [Scatter Plots](#)
- [Q-Q Plots](#)
- [Box Plots](#)
- [Univariate Graphs](#)

Variations of these are described relative to the data objects for which they are relevant.

Leapfrog Geo uses fixed 25%/75% quartiles.

Table of Statistics

For many data tables, you can view a table of statistics for multiple attributes. If the table has one or more category columns, data can, optionally, be grouped by category. To open a table of statistics, right-click on a data table then select **Statistics**. In the window that appears, select the **Table of Statistics** option.

In this example, we have the initial table of statistics for a merged table that has two category columns and four numeric columns, plus an **Interval Length** column. However, nothing is displayed in the table because data columns have not yet been selected.

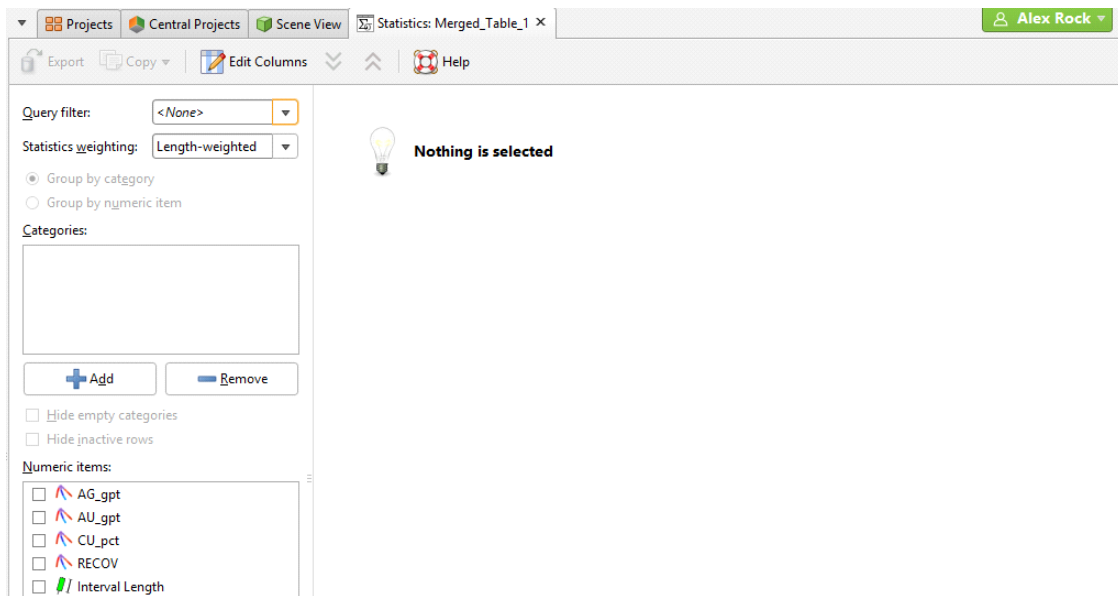

Select from the **Numeric items** available for the table. In this case, all columns have been selected, including the **Interval Length** column:

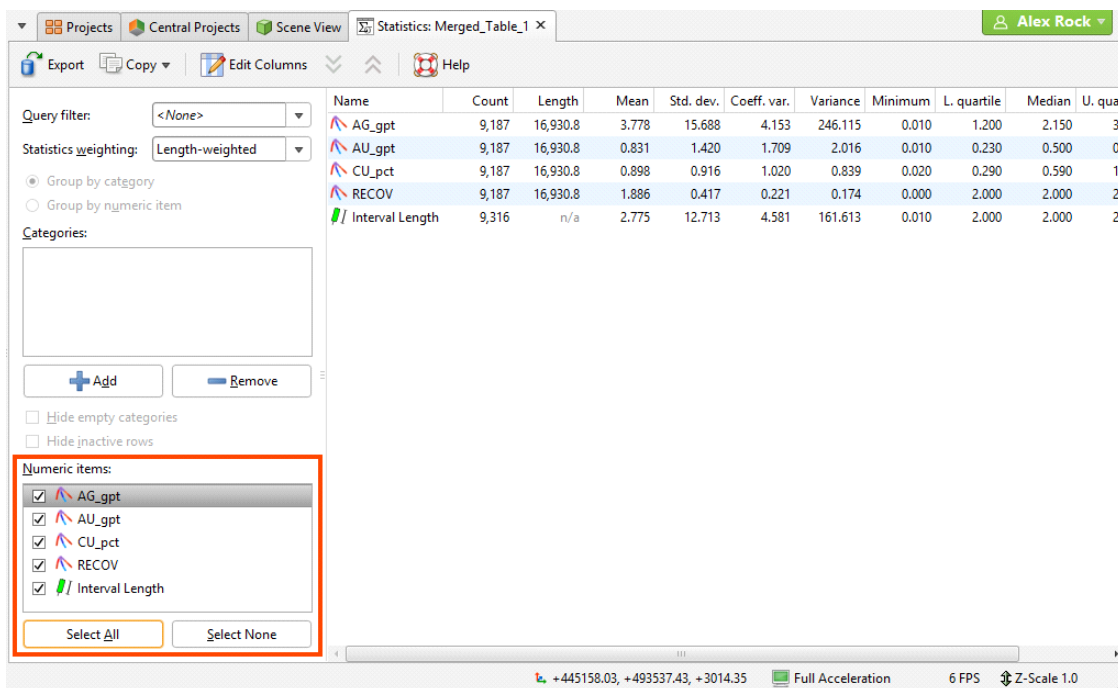

Click the **Add** button to select from the category columns available in the table. An entry will be added to the **Categories** list. Click on the arrow to select from the available category columns:

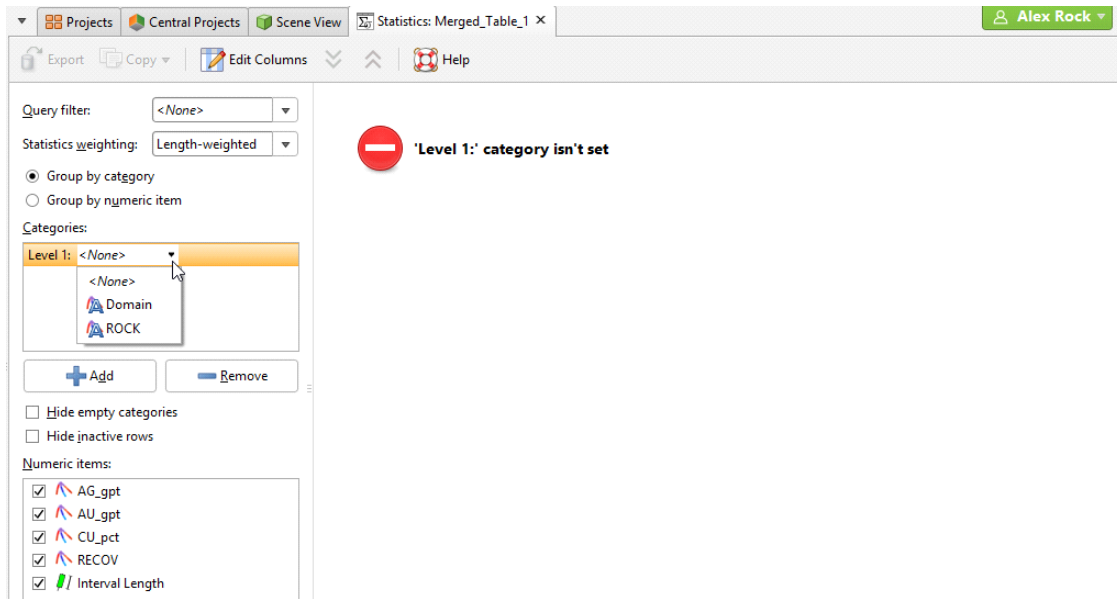

Statistics for the selected category column will be displayed in the table. You can change what categories are displayed by clicking on the second button and enabling or disabling categories:

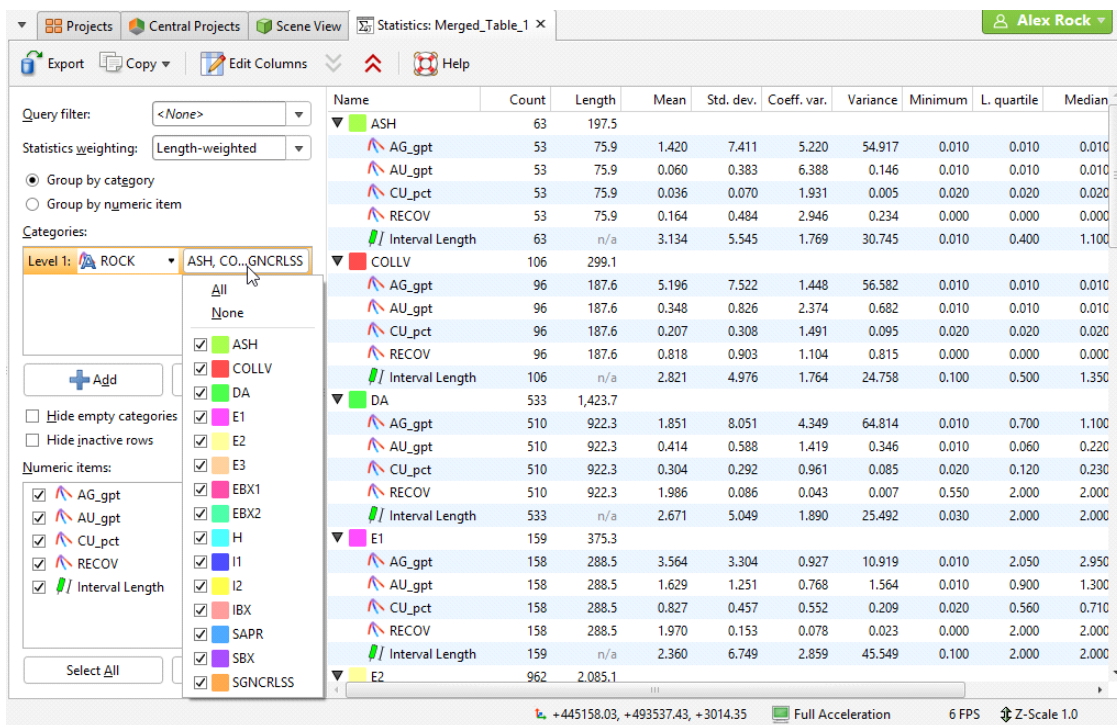

If there is more than one category column, you can set lower levels. Here there are two category columns displayed in the table, "ROCK" and "Domain":

Name	Count	Length	Mean	Std. dev.	Coeff. var.	Variance	Minimum	L. quartile	Med
ASH	63	197.5							
AG_gpt	53	75.9	1.420	7.411	5.220	54.917	0.010	0.010	0.
AU_gpt	53	75.9	0.060	0.383	6.388	0.146	0.010	0.010	0.
CU_pct	53	75.9	0.036	0.070	1.931	0.005	0.020	0.020	0.
RECOV	53	75.9	0.164	0.484	2.946	0.234	0.000	0.000	0.
Interval Length	63	n/a	3.134	5.545	1.769	30.745	0.010	0.400	1.
Ore	23	38.8							
AG_gpt	23	38.8	2.644	10.653	4.029	113.484	0.010	0.010	0.
AU_gpt	23	38.8	0.033	0.113	3.427	0.013	0.010	0.010	0.
CU_pct	23	38.8	0.039	0.065	1.679	0.004	0.020	0.020	0.
RECOV	23	38.8	0.271	0.622	2.293	0.387	0.000	0.000	0.
Interval Length	23	n/a	1.685	2.522	1.496	6.359	0.010	0.400	0.
waste	30	37.2							
AG_gpt	30	37.2	0.144	0.898	6.255	0.807	0.010	0.010	0.
AU_gpt	30	37.2	0.088	0.541	6.151	0.292	0.010	0.010	0.
CU_pct	30	37.2	0.034	0.078	2.327	0.006	0.020	0.020	0.
RECOV	30	37.2	0.052	0.292	5.584	0.086	0.000	0.000	0.
Interval Length	30	n/a	1.239	1.458	1.177	2.127	0.100	0.350	0.
COLLV	106	299.1							
AG_gpt	96	187.6	5.196	7.522	1.448	56.582	0.010	0.010	0.
AU_gpt	96	187.6	0.348	0.826	2.374	0.682	0.010	0.010	0.

You can hide empty categories (those with a count of zero) and inactive rows using the options below the **Categories** list:

Group by category and **Group by numeric item** provide further options for the table organisation. Here the **Group by numeric item** option has been selected:

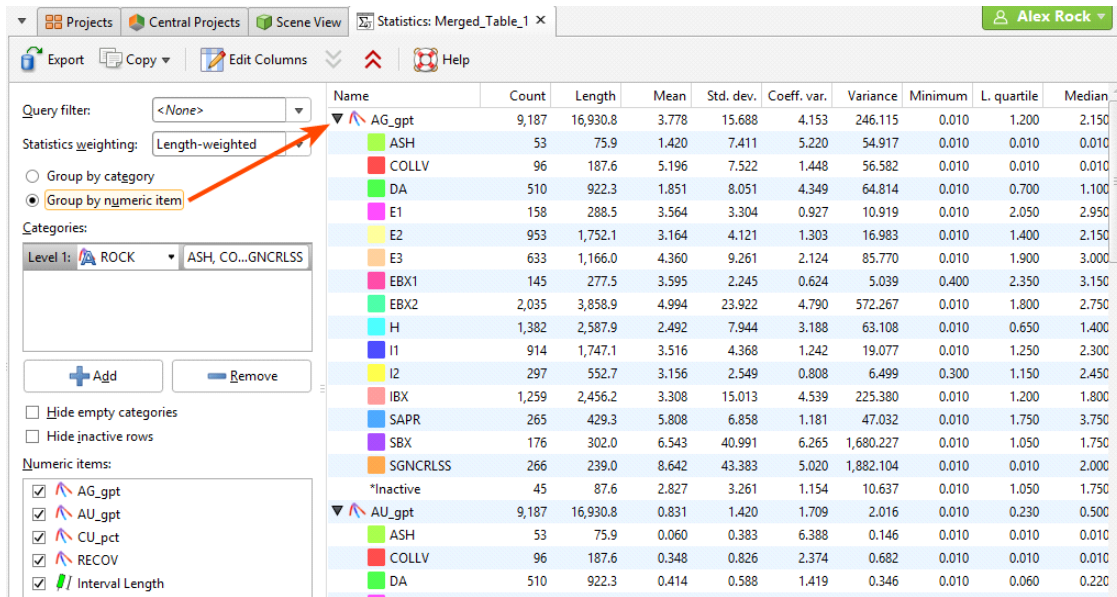

You can filter the data using any **Query filter** defined for the data table. Statistics for interval tables can be unweighted or weighted by interval length.

Change the columns displayed in the table by clicking on the **Edit Columns** button:

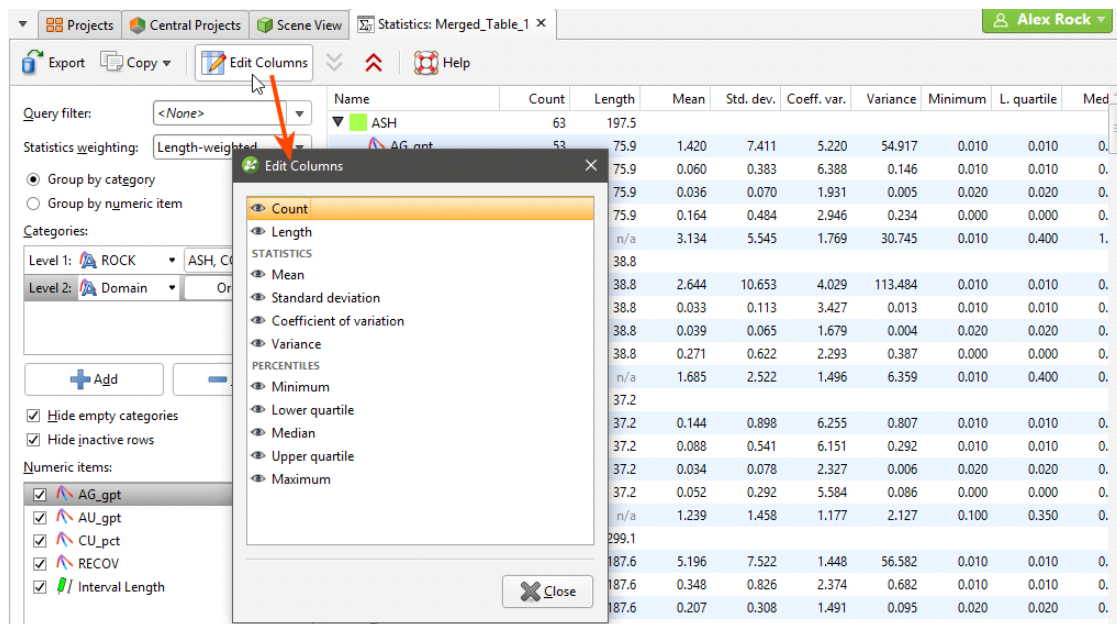

Once you have set up a table of statistics on a particular table, its settings will be saved so you can easily review the statistics and export the table using the same settings.

To export the table in CSV format, click on the **Export** button in the toolbar (📄).

Other controls in this window are as follows:

- The arrow buttons at the top of the window (⏴ and ⏵) allow you to quickly expand or collapse the rows.

- Click rows to select them.
- Select multiple rows by holding down the Shift or Ctrl key while clicking rows.
- The **Copy** button (📄) copies the selected rows to the clipboard so you can paste them into another application.

Scatter Plots

Scatter plots are useful for understanding relationships between two variables. An additional variable can be introduced by setting the **Colouring** option to a data column. The example below plots the two variables lead and zinc against each other, with gold being indicated by the colouring. You can make either axis a log scale with the **Log scale in X** and **Log scale in Y** options. A **Query filter** may be applied also.

The appearance of the chart can be modified by adjusting the **Point size**, **Point shape**, and **White background** settings.

Enable **Show X = Y line** to aid in assessing how far off equal the distributions are.

When you select **Show linear regression**, a regression line is added to the chart and a function equation is added below the chart title.

Show conditional expectation plots a line that attempts to find the expected value of one variable given the other. The X axis is divided into a number of bins specified by **Bin count**, and the data in each bin is used to predict the expected Y value.



By default, the limits of the chart are automatically set to range between zero and the upper limit of the variable data. You can adjust this by turning off **Automatic X axis limits** and/or **Automatic Y axis limits** and specifying preferred minimum and maximum values for each axis. Select points in the scatter plot by clicking and dragging your mouse pointer to draw freehand around the points.

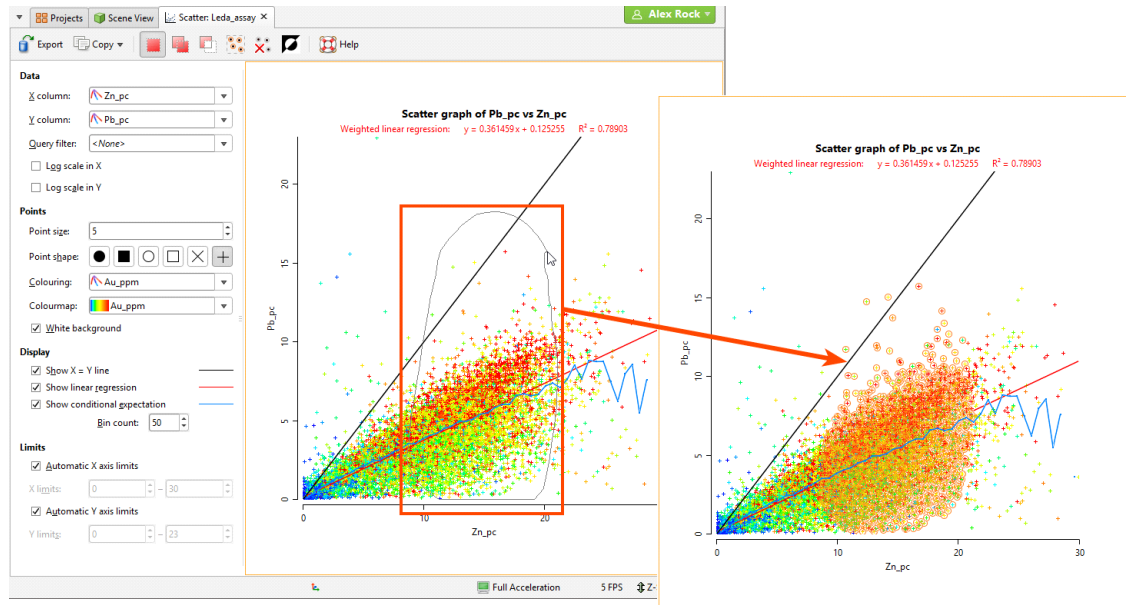

Selected points can be filtered in the scene by selecting the scatter plot from the **Query filter** options in the shape properties panel.

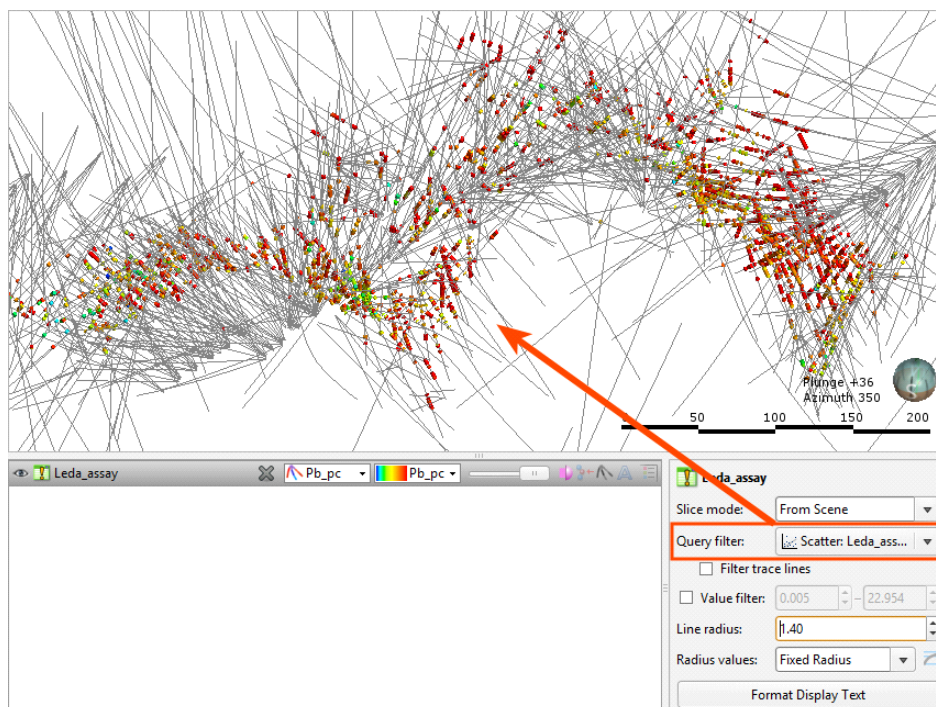

The **Add** button (📁) and the **Remove** button (🗑️) determine whether selected points are being added to or removed from the selection. For example, if you draw a polygon around a set of points with the **Add** button enabled, the points will be added to the selection.

You can also:

- Remove points from a selection while the **Add** button (📌) is enabled by holding down the Ctrl key and selecting points.
- Select all visible points by clicking on the **Select All** button (👤) or by pressing Ctrl+A.
- Clear all selected points by clicking on the **Clear Selection** button (✖) or by pressing Ctrl+Shift+A.
- Swap the selected points for the unselected points by clicking on the **Invert Selection** button (🔄) or by pressing Ctrl+I.

Q-Q Plots

Quantile-Quantile plots are useful for validating your assumptions about the nature of distributions of data. Select the data columns to show on the **X Axis** and **Y Axis** (which can optionally be set as log scales). You can also select an **X filter** and/or **Y filter** to limit the values used from the data columns.

Enable **Show X = Y line** to plot the mirror line for the chart, which may not always be obvious when the X and Y axis have different scales.

Show quartile line draws a line through two points on the chart, the lower quartiles and the upper quartiles for each of the axes.

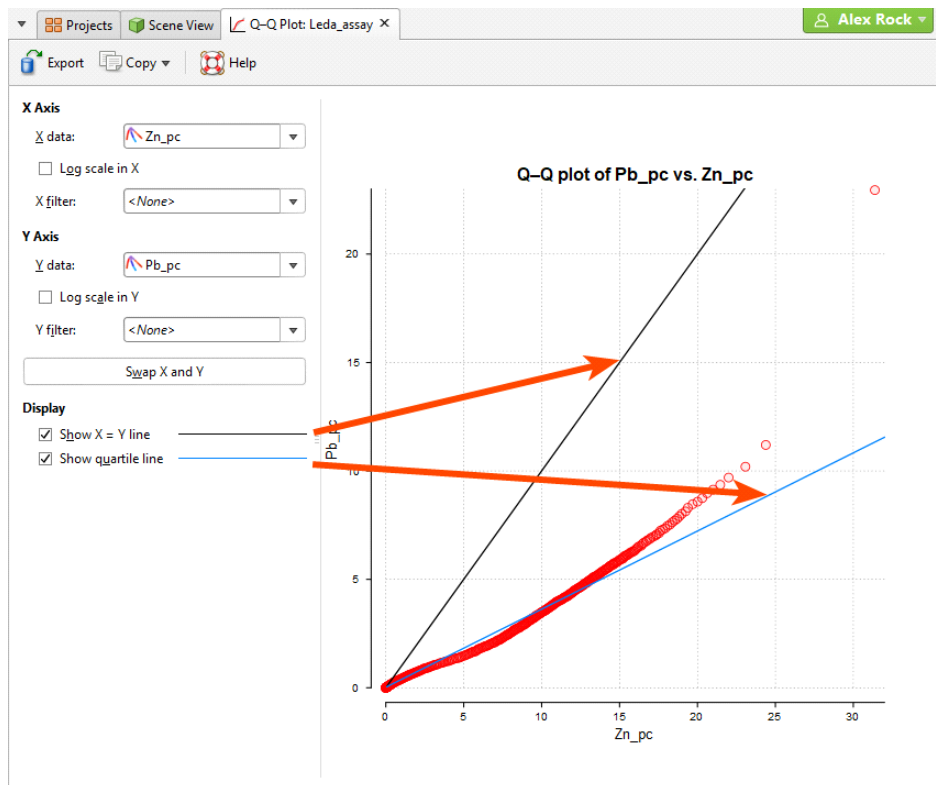

Box Plots

The box plot (or box-and-whisker plot) provides a visualisation of the key statistics for a data set in one diagram.

Select a **Numeric column** to display, enabling **Log scale** if it helps to visualise the data more clearly. If the table includes category data, set the **Category column** to one of the category columns to help visualise the data. Select which categories to include from the **Categories** list.

You can also use a pre-defined **Query filter** to limit the data included in the chart.

Note these features of the plot:

- The mean is indicated by the red diamond.
- The median is indicated by the line that crosses the inside of the box.
- The box encloses the interquartile range around the median.
- The whiskers extend out to lines that mark the extents you select, which can be the **Minimum/Maximum**, the **Outer fence** or the **Inner fence**. Outer and inner values are defined as being three times the interquartile range and 1.5 times the interquartile range respectively.

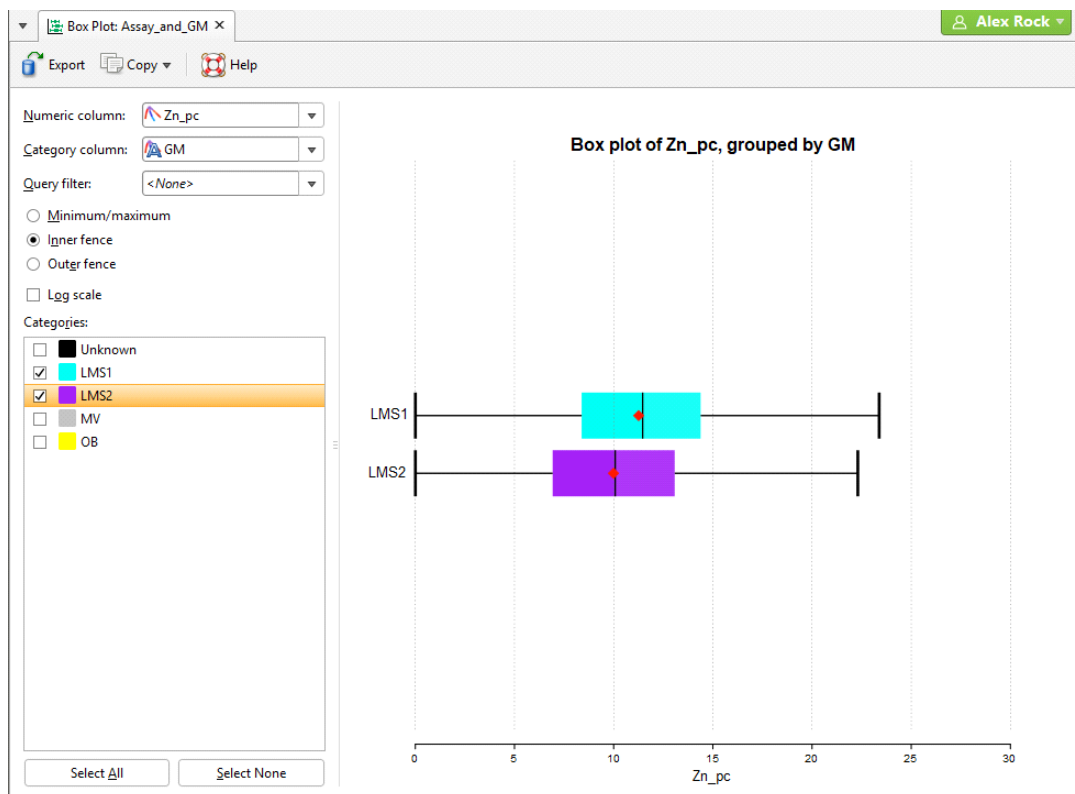

Note that a reminder of the reference for the **Outer fence** and **Inner fence** can be found by holding your mouse cursor over these fields to see the tooltip.

Univariate Graphs

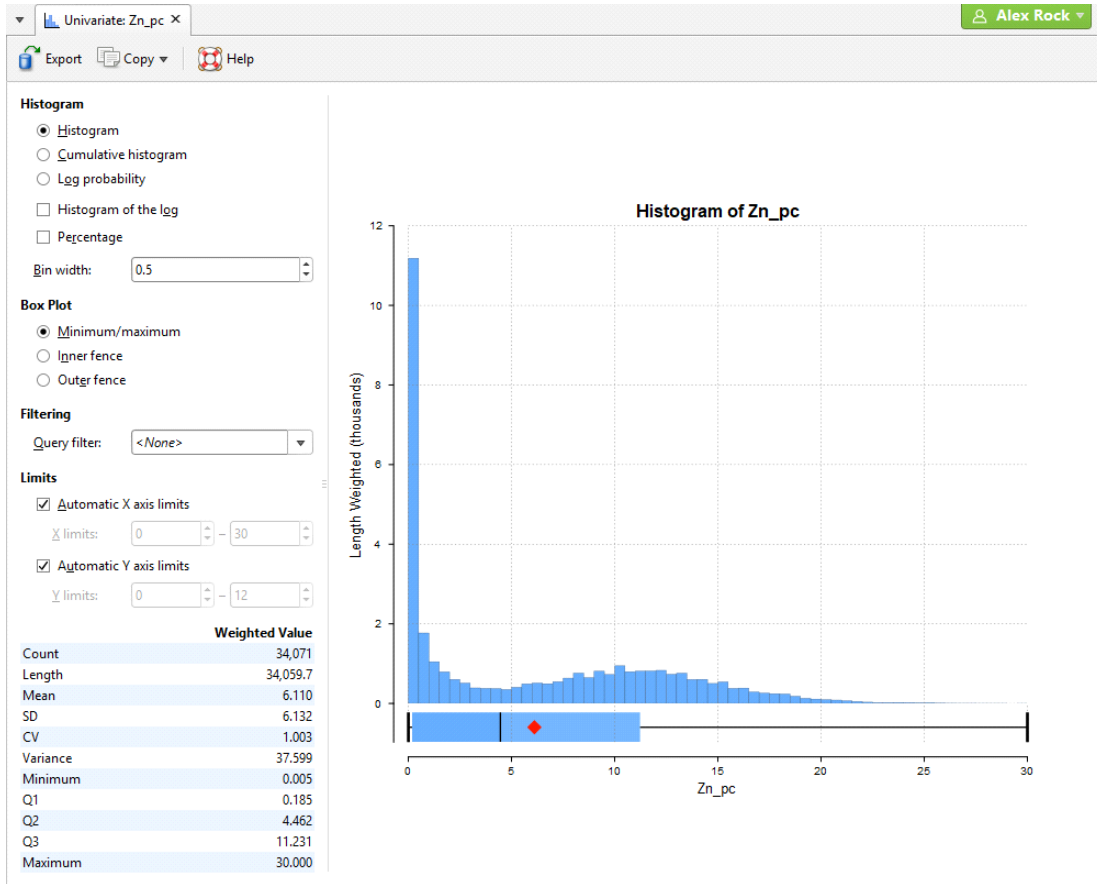

There are several different visualisation options. **Histogram** shows a probability density function for the values, and **Cumulative Histogram** shows a cumulative distribution function for the values as a line graph:

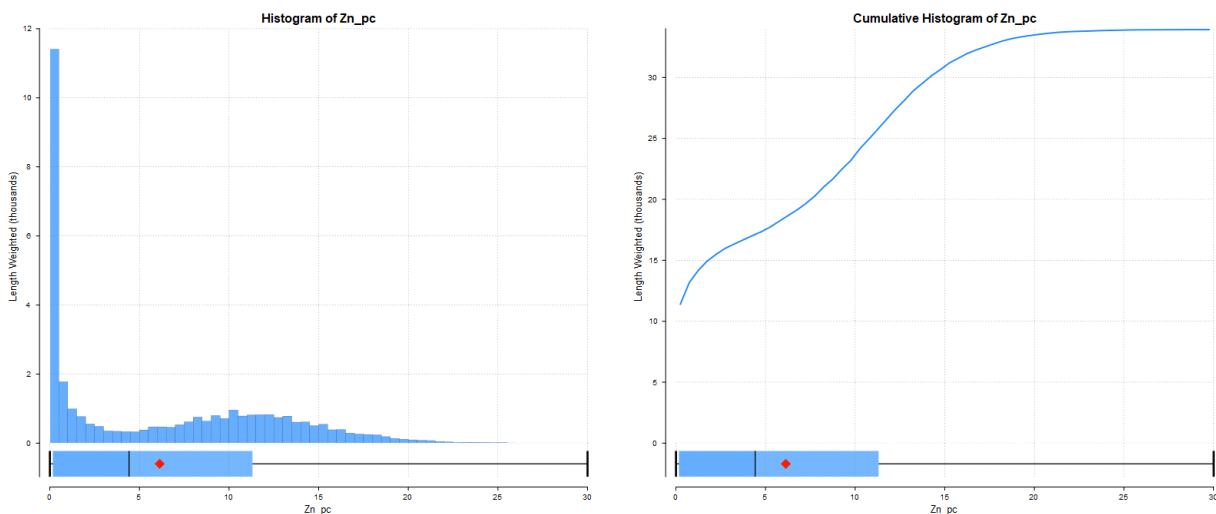

There are three options that show the charts with a log scale in the X-axis:

- Select **Histogram** and enable **Histogram of the log** to see the value distribution with a log scale X-axis.

- Select **Cumulative Histogram** and enable **Histogram of the log** to see a cumulative distribution function for the values with a log scale X-axis.
- **Log Probability** is a log-log weighted cumulative probability distribution line chart.

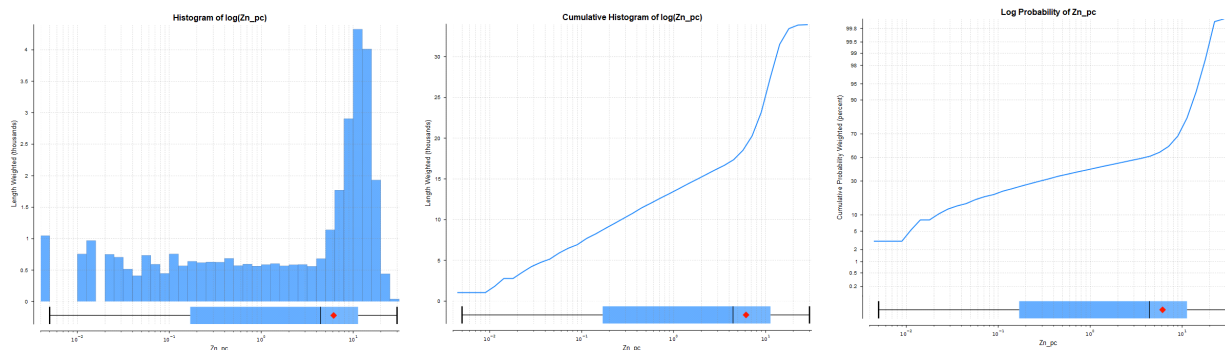

Percentage is used to change the Y-axis scale from a length-weighted scale to a percentage scale.

Bin width changes the size of the histogram bins used in the plot.

The **Box Plot** options control the appearance of the box plot drawn under the primary chart.

The whiskers extend out to lines that mark the extents you select, which can be the **Minimum/maximum**, the **Inner fence** or the **Outer fence**. Inner and outer values are defined as being 1.5 times the interquartile range and 3 times the interquartile range respectively.

Some univariate graphs may include a **Filtering** option containing where a **Query filter** defined for the data set can be selected.

The **Limits** fields control the ranges for the X-axis and Y-axis. Select **Automatic X axis limits** and/or **Automatic Y axis limits** to get the full range required for the chart display. Untick these and manually adjust the **X limits** and/or **Y limits** to constrain the chart to a particular region of interest. This can effectively be used to zoom the chart.

The bottom left corner of the chart displays a table with a comprehensive set of statistical measures for the data set.

Drillhole Correlation Tool

With the drillhole correlation tool, you can view and compare selected drillholes in a 2D view. You can then create interpretation tables in which you can assign and adjust intervals and create new intervals. Interpretation tables are like any other interval table in a project and can be used to create models. You can also save and export correlation set layouts and styles that can be exported and used in other Leapfrog Geo projects.

This topic describes creating correlation sets and creating interpretation tables. It is divided into:

- [Selecting Collars](#)
- [The Correlation Set Window](#)
- [Correlation Column Layouts](#)
- [Managing Styles](#)
- [Interpretation Tables](#)

Selecting Collars

To select collars, you need to create a drillhole correlation set, which you can do from the scene. First, add the collars you wish to work with to the scene. A useful way of limiting the number of collars displayed is to draw a slice in the scene and set it to a thick slice (🔪) and set the slice width to hide collars on either side of the slice.

Next, right-click on the **Drillhole Correlation** folder and select **New Drillhole Set**. The new set will be created and opened, but is empty until you select collars. Click the **Select Collars** button (🔗) to switch to the scene and begin selecting collars:

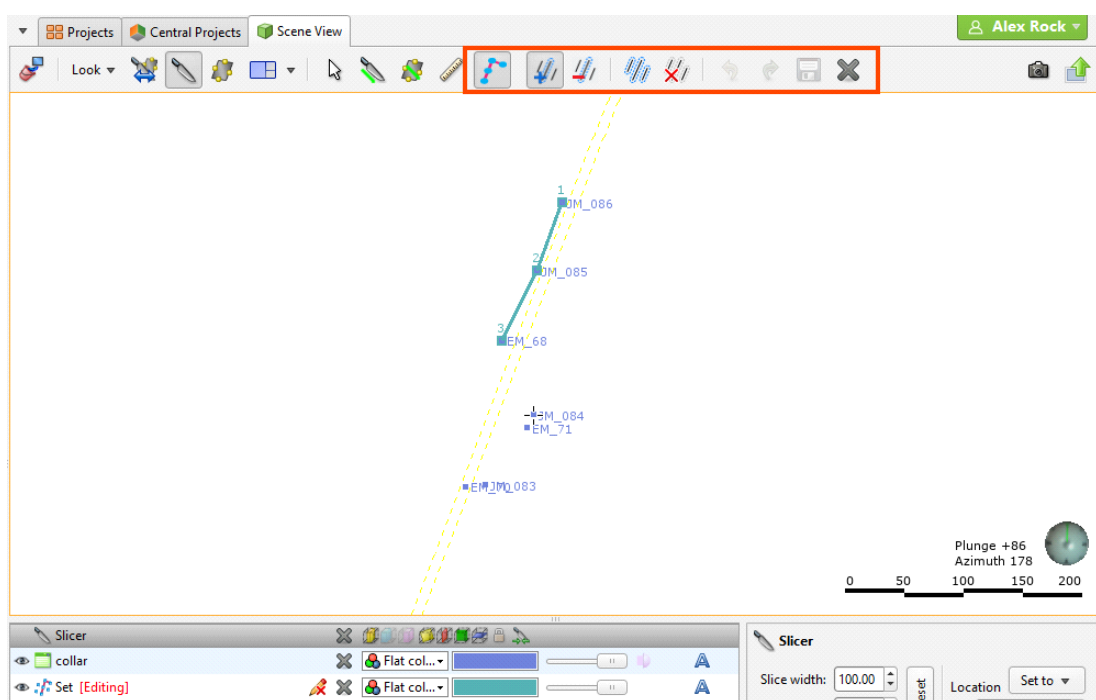

The line in the scene indicates the order in which collars will appear in the set.

- To select collars one-by-one, click on the **Select collar** button (🔍), then on the **Add collar** button (➕). Click on a collar to add it to the nearest end of the set. Hold down the Ctrl key while clicking to remove a collar from the set.
- To temporarily switch to the **Select** button (👉), hold down the Shift key while clicking.
- To select all collars visible in the scene, click on the **Select all collars** button (👉). This will select collars using the best fit line.
- To remove a collar from the selection, click on the **Remove collar** button (➖), then click on the collar you wish to remove from the set.
- To clear the selection, click on the **Clear collar selection** button (✖).

If you want to change the order, you can easily do so in the set tab once you have selected collars.

Once you have selected the required collars, click the **Save** button (💾). The selected collars will be added to the set window:

EM_70	JM_083	EM_71	JM_084	EM_68	JM_085	JM_086	EM_72	EM_73
Depth	Depth	Depth	Depth	Depth	Depth	Depth	Depth	Depth
0.0	0.0	0.0	0.0	0.0	0.0	0.0	0.0	0.0
10.0	10.0	10.0	10.0	10.0	10.0	10.0	10.0	10.0
20.0	20.0	20.0	20.0	20.0	20.0	20.0	20.0	20.0
30.0	30.0	30.0	30.0	30.0	30.0	30.0	30.0	30.0
40.0	40.0	40.0	40.0	40.0	40.0	40.0	40.0	40.0
50.0	50.0	50.0	50.0	50.0	50.0	50.0	50.0	50.0
60.0	60.0	60.0	60.0	60.0	60.0	60.0	60.0	60.0
70.0	70.0	70.0	70.0	70.0	70.0	70.0	70.0	70.0
	80.0	80.0	80.0	80.0	80.0	80.0		
	90.0	90.0	90.0	90.0	90.0	90.0		
			100.0		100.0	100.0		
					110.0	110.0		

The Correlation Set Window

Remove collars from the correlation set by either editing the set in the scene, as described in [Selecting Collars](#) above, or right-click on a column and select **Remove collar**:

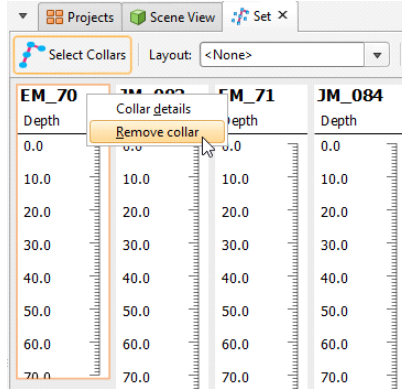

You can change how data is displayed by clicking on the column header, then selecting **Format**:

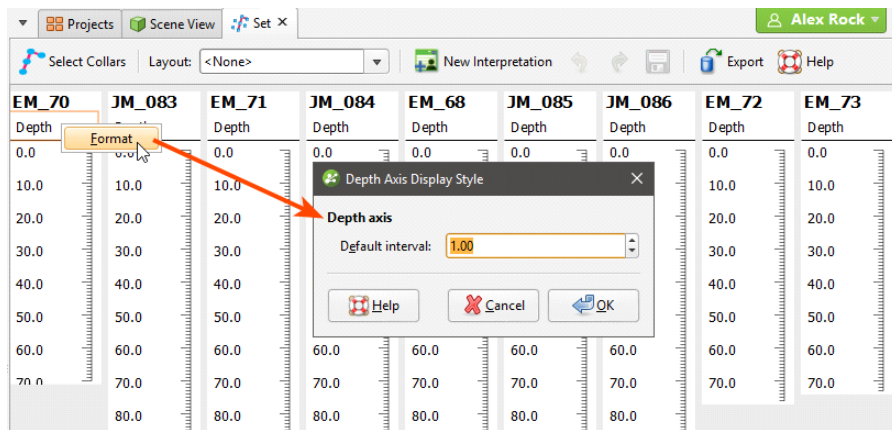

The options available depend on the type of column being formatted.

Click on drillholes and drag them in the correlation set window to change the order in which they appear:

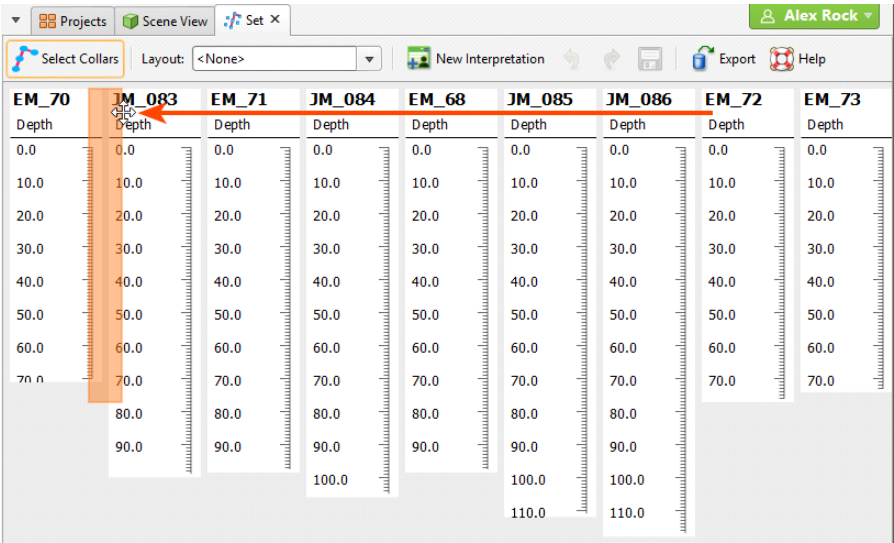

Add columns to the set by dragging them from the project tree into the set window. Here, four columns have been added to the set. From right to left they are a lithology column, an assay data column, a points data column formatted as a line and a points data column formatted as points:

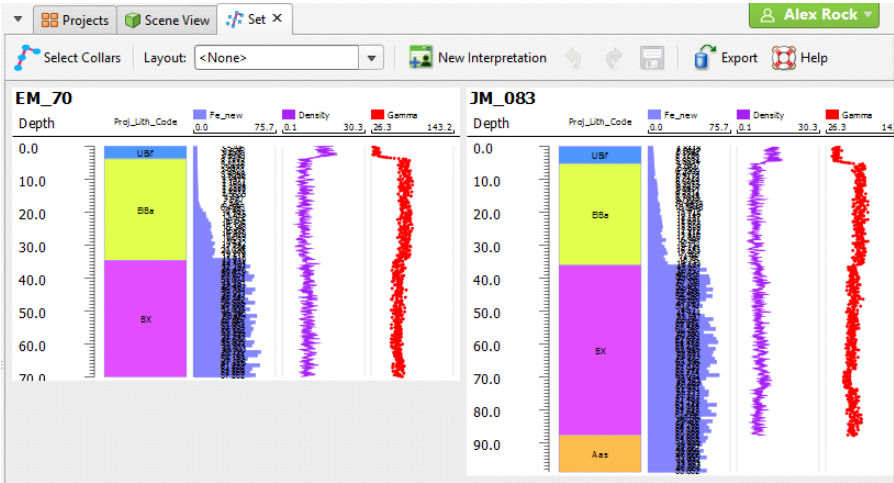

You can then format the columns to get a better view of relationships between them. Format columns by right-clicking on their headers and selecting **Format**:

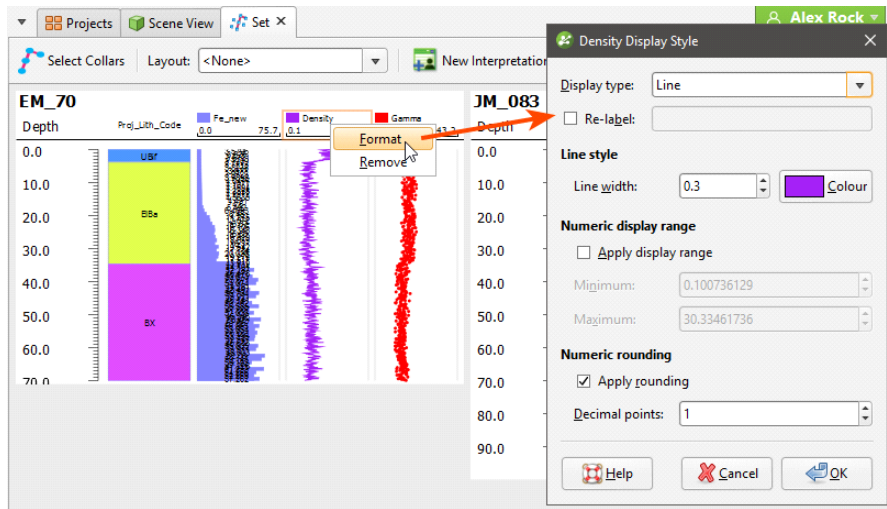

The styles used to display columns can be used by other sets in the project and can be exported to other projects. See [Managing Styles](#) below.

You can also drag some types of columns on top of other columns, although it is not possible to display category data on top of other category data. You can select multiple columns using the Shift and Ctrl keys.

Navigating in the Correlation Set Window

Navigate in the correlation set window using the following mouse and keyboard combinations:

- Use the scroll wheel to move up and down.
- Hold down the Shift key while scrolling to move right and left.
- Hold down the Ctrl key while scrolling to zoom in and out.
- Hold down the Alt key while scrolling to stretch the data vertically.

Correlation Column Layouts

Once you have organised data columns and how they are displayed, you can save this information as a column layout that can be applied to other correlation sets. To do this, click the **Layout** button in the toolbar and select **Save Current Layout** from the list:

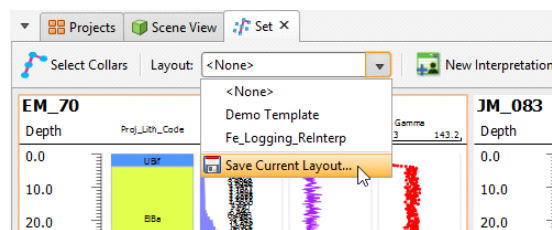

You will be prompted for a name. Click **OK** to save the layout, which can then be applied to other correlation sets by selecting the layout from the list.

To view the layouts available in the project, right-click on the **Drillhole Correlation** folder in the project tree and select **Layout Manager**. In the window that appears, you can easily see what columns are used for each layout and apply a layout to all correlation sets in a project:

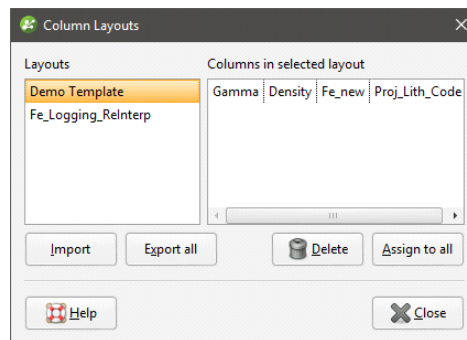

You can also export column layouts for use in other projects and import layouts from other projects. Clicking **Export all** exports layouts as a text file.

Managing Styles

The styles used to display data columns can also be exported to other projects. To view the styles used in the project, right-click on the **Drillhole Correlation** folder in the project tree and select **Style Manager**:

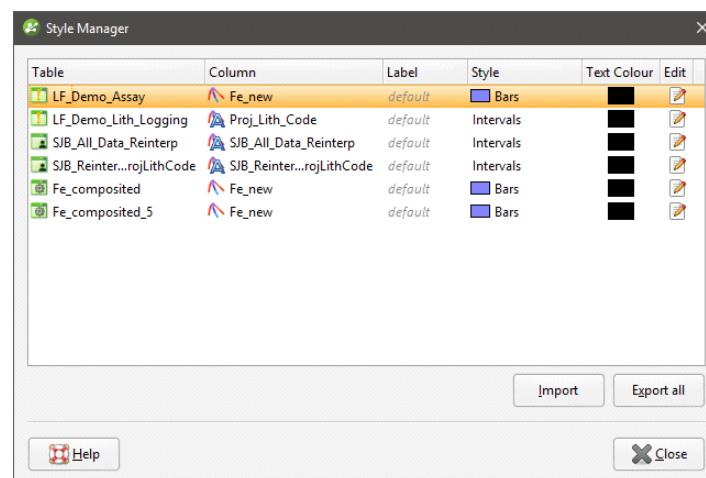

Click **Edit** to change a style, which will update objects that use the selected style throughout the project.

Click **Export all** to export the styles in the project as a text file that can be imported into other projects.

Interpretation Tables

With interpretation tables, you can assign and adjust intervals and create new intervals. Interpretation tables are like any other interval table in a project and can be used to create models.

To create an interpretation table, click the **New Interpretation** button in the correlation set window. The **New Interpretation Table** window will be displayed:

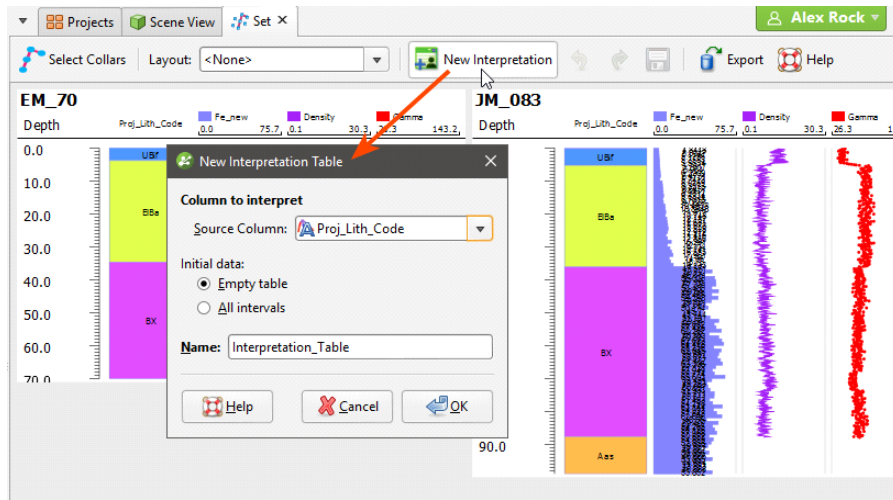

There are three options for creating an interpretation table:

- Create the table without using a base table. Each drillhole will have an empty legend and a single empty interval from 0 to its maximum depth. Select **<None>** for the **Source Column**.
- Create the table from a base column but have no intervals. This copies the base column's legend but no intervals. Select the **Source Column**, then select **Empty Table**.
- Create a copy of a table. Select the **Source Column**, then select **All Intervals**.

Click **OK** to create the table. A new interpretation table will be added to the project tree under the **Drillholes** object and the column will be added to the correlation set window:

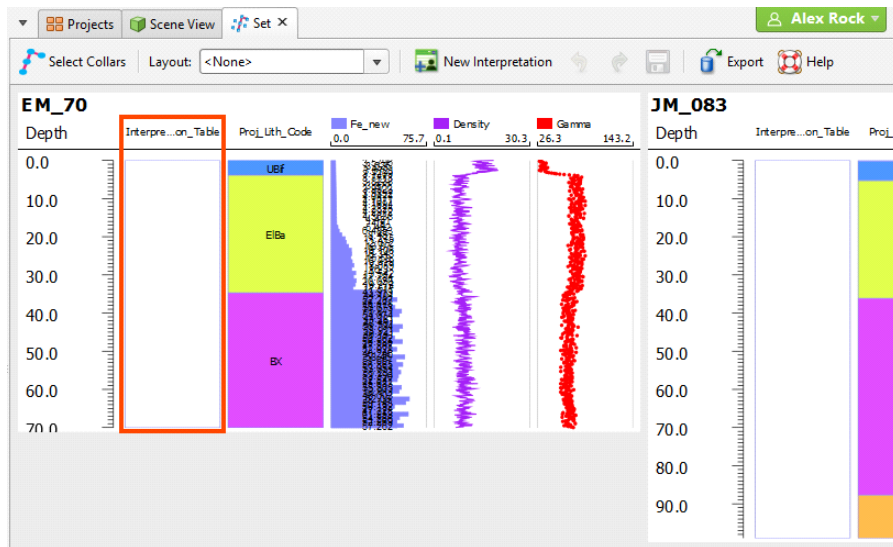

Assigning Lithologies

If you have created the interpretation table without using a base table, you will need to assign lithologies to the new table. Do this as part of working with the table in the correlation set window, which is described below.

Modifying the Interpretation Table

In the correlation set window, the blue line is used to create intervals. Position the blue line then right-click on it and select one of the options:

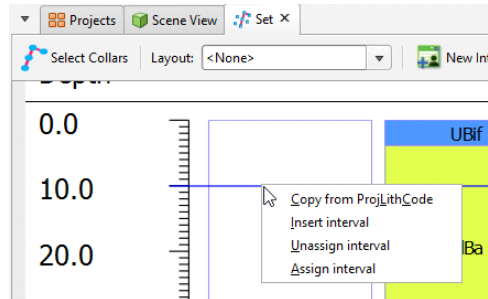

- The **Copy from** option assigns intervals from the base table.
- The **Insert interval** option adds an empty interval that overrides any intervals already defined.
- The **Unassign interval** option clears the lithology assigned to the interval.
- The **Assign interval** option opens the legend for the interpretation table so you can select a lithology to assign to the interval. If you need to add lithologies, you can do so in this window.

For example, to create an interval at the top of the table called "High Density", move the blue line near to where you wish to create the interval. You do not need to be precise as you can adjust the interval once you have added it. Right-click and select **Insert interval**:

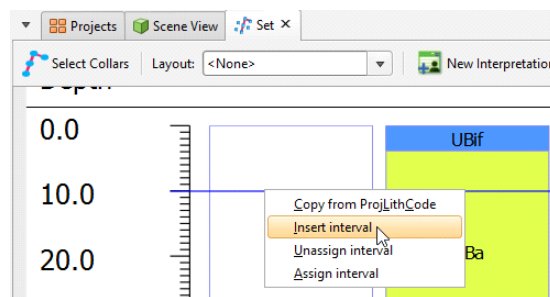

In the legend window, click the **Add** button and add a lithology called “High Density”:

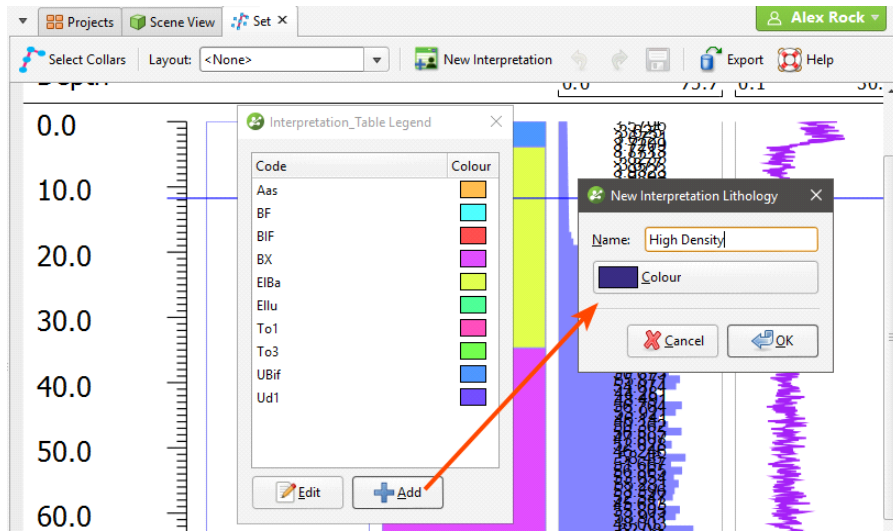

Click **OK**, then select the new lithology to close the legend window. The new lithology has been assigned to the interval:

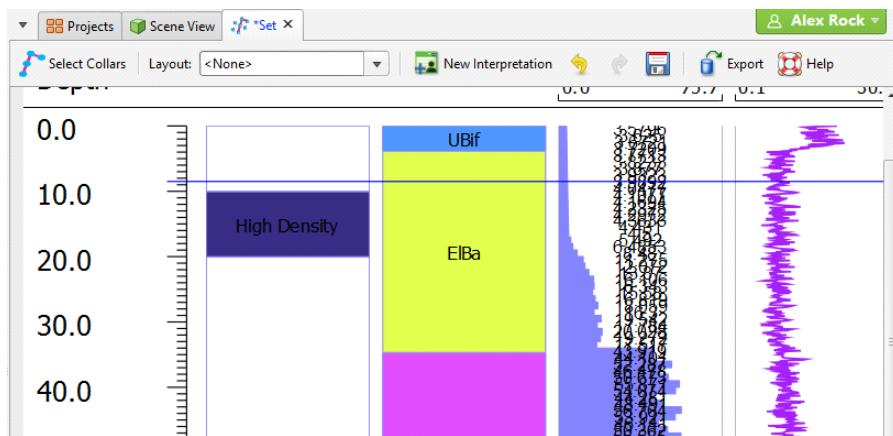

To resize the interval, click and drag the interval end points:

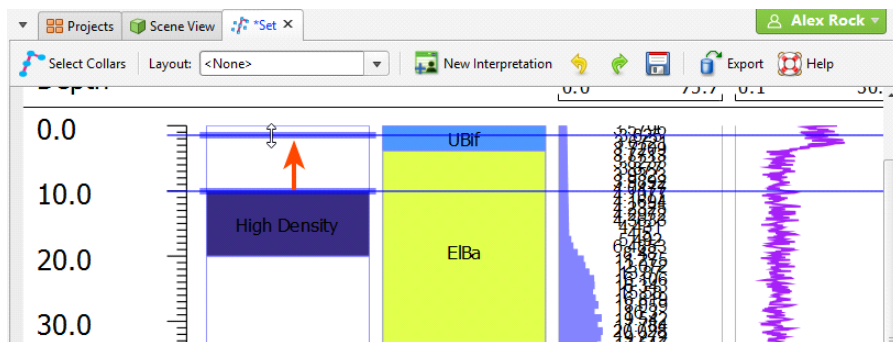

You can move the interval end point and snap it to a data point in another column. To do this:

1. Click on the interval end point and drag it into position without releasing the mouse button.
2. Move the mouse across to the data point you wish to snap to.
3. Release the mouse.

You can also snap to points along the depth axis.

Continue making changes to the interpretation table, using the **Undo** button to step backwards if necessary. Save changes to update the table.

Stereonets

Stereonets are useful for visualising structural data and identifying trends in 2D. Errors in categorisation of structural data can also become apparent when the data is viewed on a stereonet.

There are two types of stereonets available in Leapfrog Geo: equatorial stereonets and polar stereonets. The process of creating a stereonet is the same for both types; you can change the type of stereonet by clicking the **Options** button in the stereonet window. Both Fisher and Bingham statistics are available for stereonets.

This topic describes how to work with stereonets in Leapfrog Geo. It covers:

- [Creating a Stereonet](#)
- [Displaying the Stereonet in the 3D Scene](#)
- [Plot Options](#)
- [Data Display Options](#)
- [Viewing Stereonet Statistics](#)
- [Selecting Data in the Stereonet](#)
- [Using the Scene Window with the Stereonet](#)
- [Exporting a Stereonet](#)

Creating a Stereonet

Create a stereonet by right-clicking on the **Stereonets** folder (in the **Structural Modelling** folder) and selecting **New Stereonet**. The stereonet is created and opened in a new tab. Click the **Add** button to add any structural data table in the project to the stereonet:

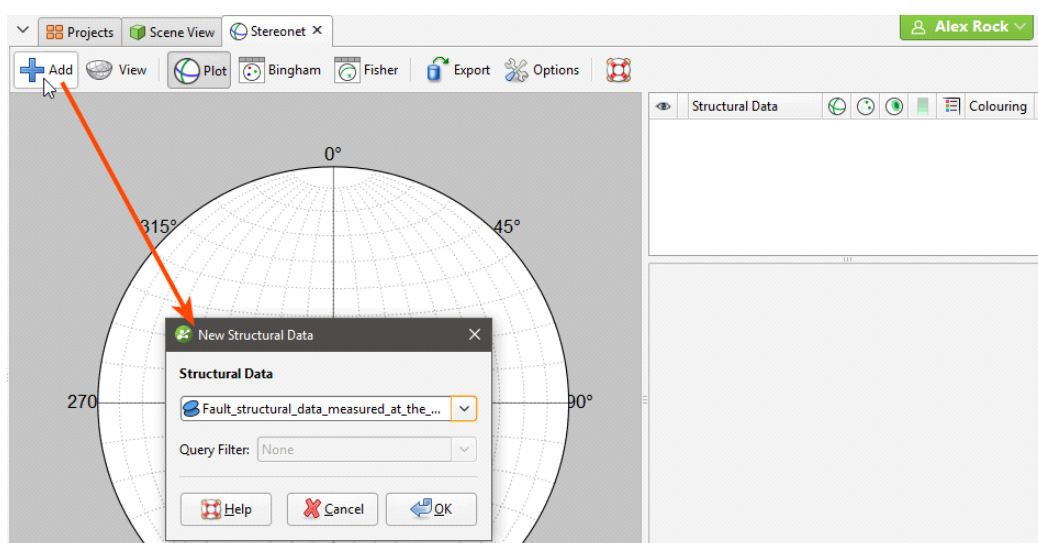

You can also drag and drop structural data objects from the project tree into the stereonet.

See [Plot Options](#) and [Data Display Options](#) below for information on the different options available for stereonet.

Displaying the Stereonet in the 3D Scene

You can display the stereonet in the 3D scene by dragging the stereonet from the project tree into the scene or by clicking on the **View** button (🌐) in the stereonet window:

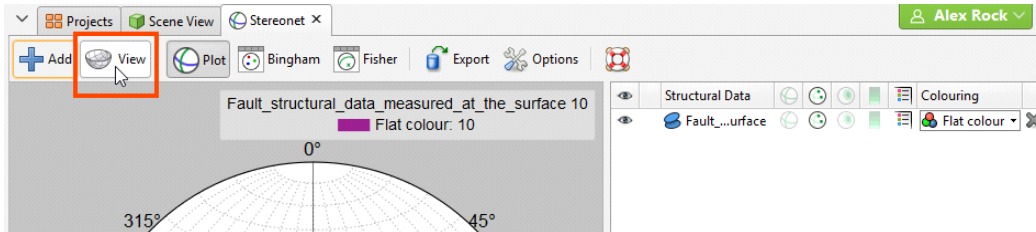

You can display planes and poles in the 3D scene, but not contours. In the shape list, you can control whether planes or poles are displayed in the scene:

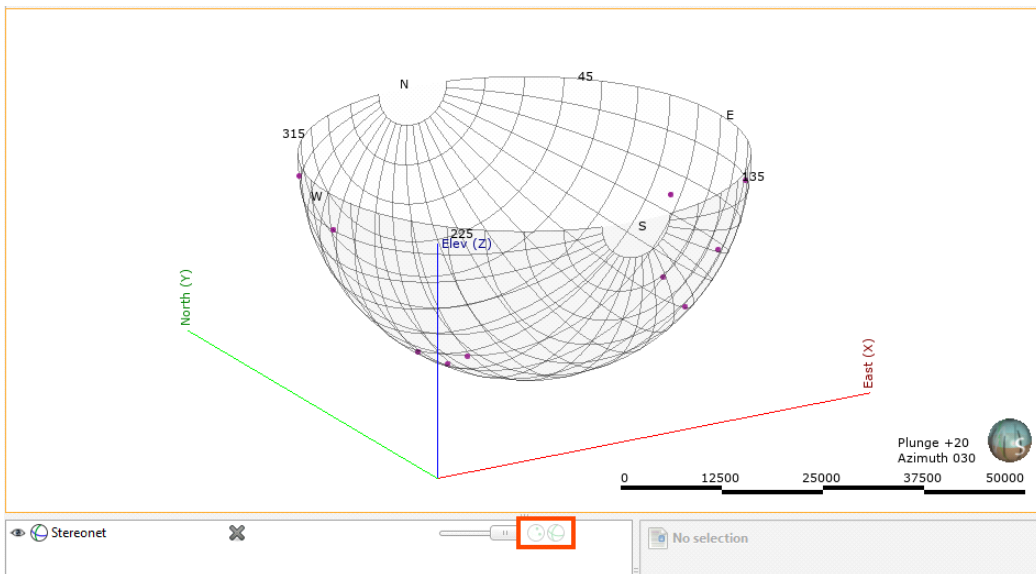

Otherwise, the appearance of the stereonet in the 3D scene is controlled from the stereonet window.

In the scene, you can:

- Resize the stereonet in the scene. Click on it and use the green arrows to resize it.
- Move the stereonet around in the scene. The controls are the same as those for the moving plane.
- Centre the stereonet on its input data. To do this, click on the stereonet in the shape list and then select from its inputs in the **Move to** list.

Plot Options

Click **Options** to change plot options:

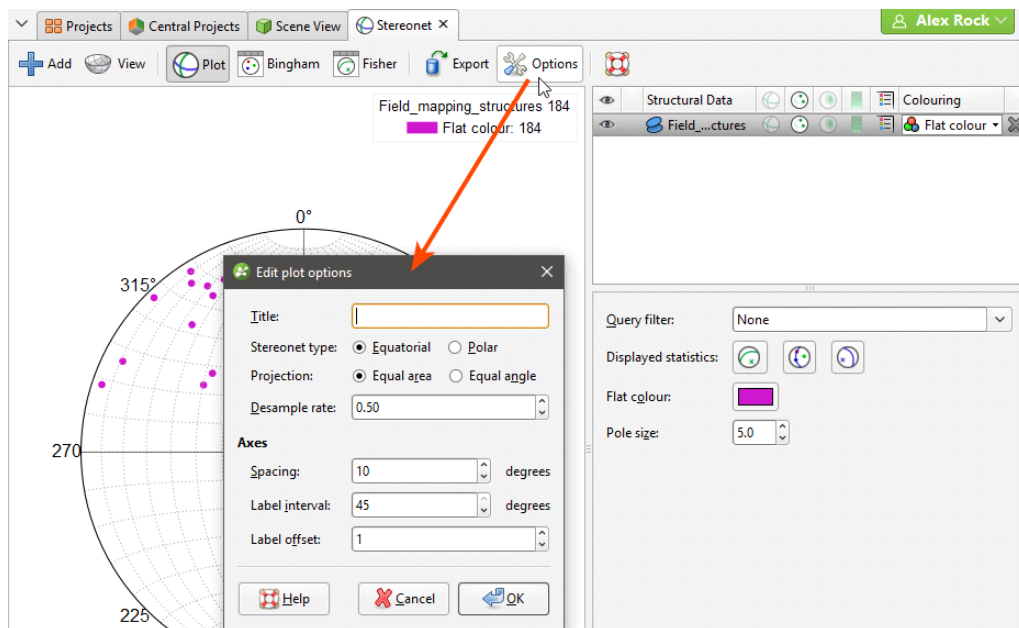

There are two types of stereonet available, **Equatorial** and **Polar**. You can also choose between **Equal area** (Schmidt) and **Equal angle** (Wulff) projections.

The **Desample rate** affects how quickly data is displayed by combining points with duplicate orientations, as determined by the **Desample rate** value. A low value will filter fewer data points, whereas a higher value will filter out more data. Setting the **Desample rate** to 0 plots all points, which may be slow for very large data sets that have not been declustered. The **Desample rate** applies only to how data is displayed; it does not affect the data in the table.

Note that the settings in **Edit plot options** window only apply to the current stereonet. If you want to create a stereonet "template" for your project, you can create a new stereonet with different plot options and make copies of it in the project tree:

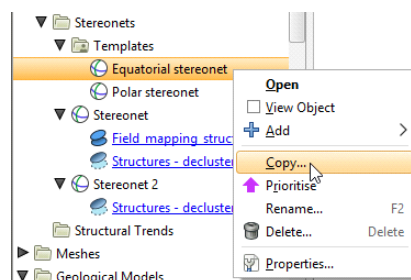

Data Display Options

Planar structural data can be displayed as planes (☉), poles (☺) or contours (☻), using the colouring from any column in the structural data table. Lineations can be displayed as poles (☺) or contours (☻). Contour methods available are **Schmidt**, **Exponential Kamb** and **Kamb**, and contours can be displayed filled or outlined.

Click on a line or pole to view information about the data point:

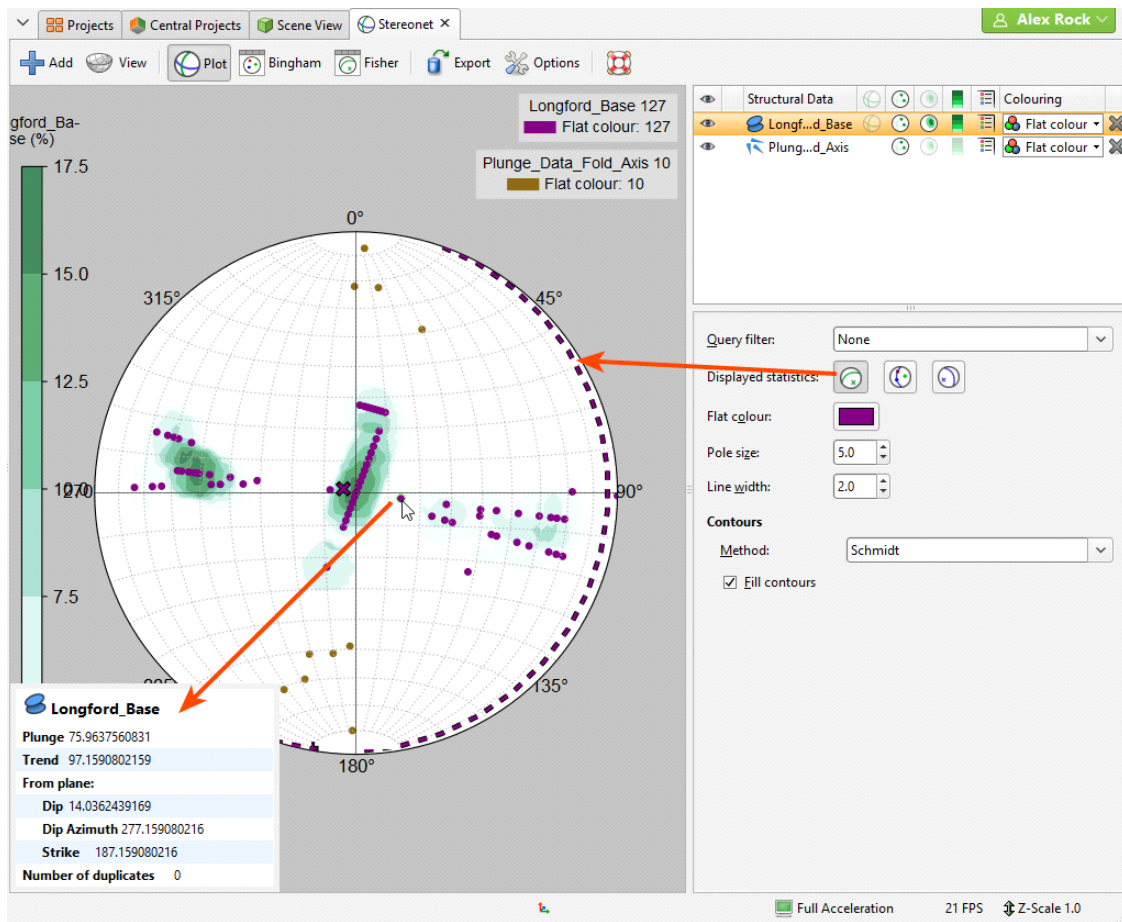

The information displayed includes whether or not there are duplicates of the selected data point in the data set.

Click the mean button (🕒) to view the Fisher mean on the stereonet, which is displayed as a line for planar structural data and as an X for lineations. You can also display the Bingham best-fit plane (🕒) and eigenvectors e1, e2 and e3:

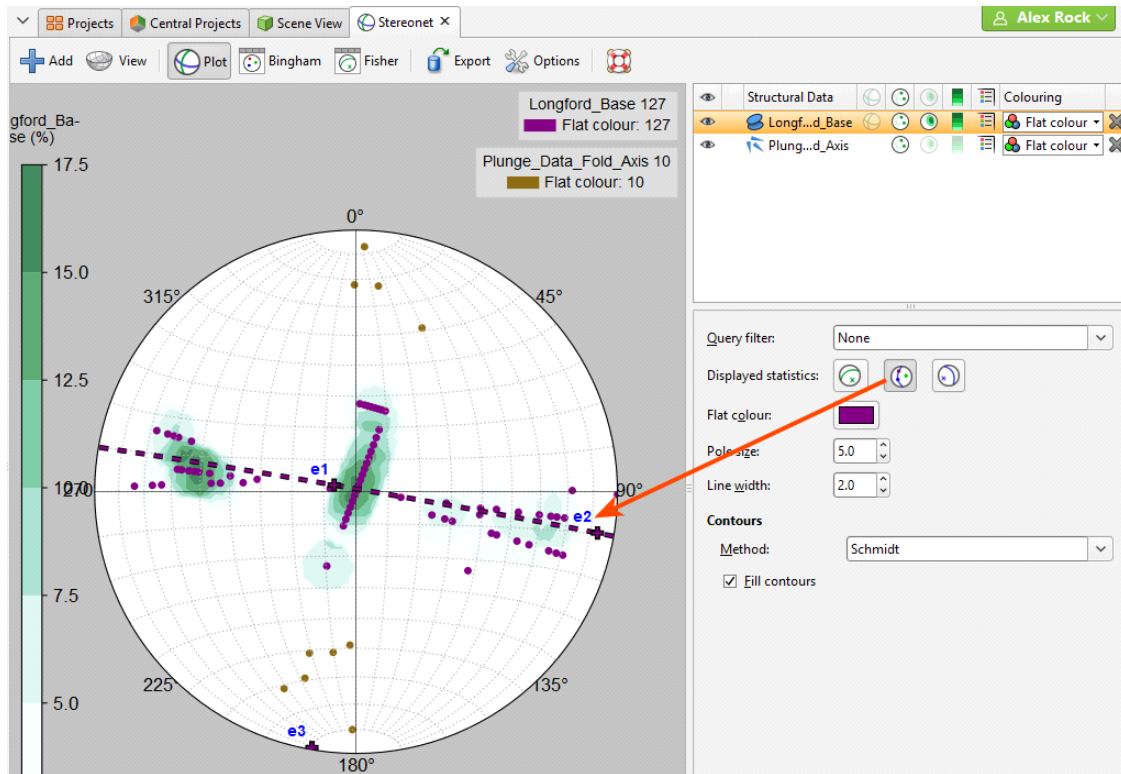

For planar structural data, you can also display the Bingham mean plane (🕒):

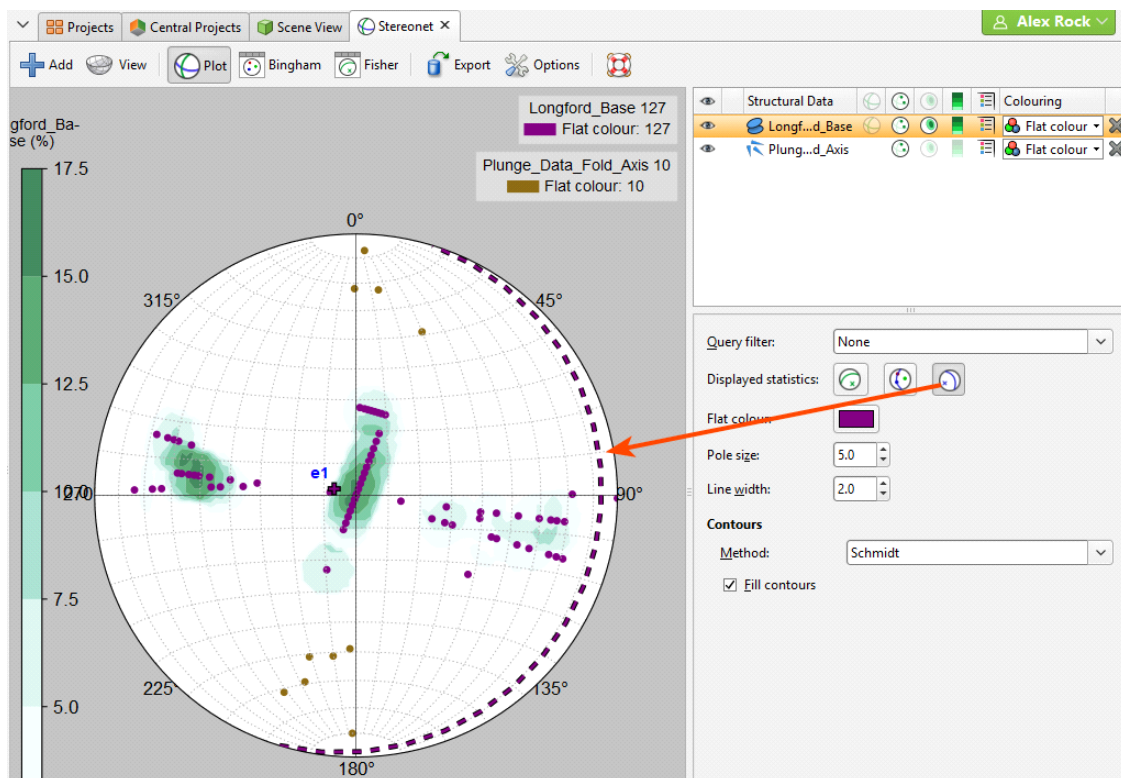

A legend can be displayed for the stereonet as a whole (📄) and for the contours (📄). The stereonet's legend is generated from the categories that are visible in the list of colourings. Here, the categories displayed are from the Bedding column:

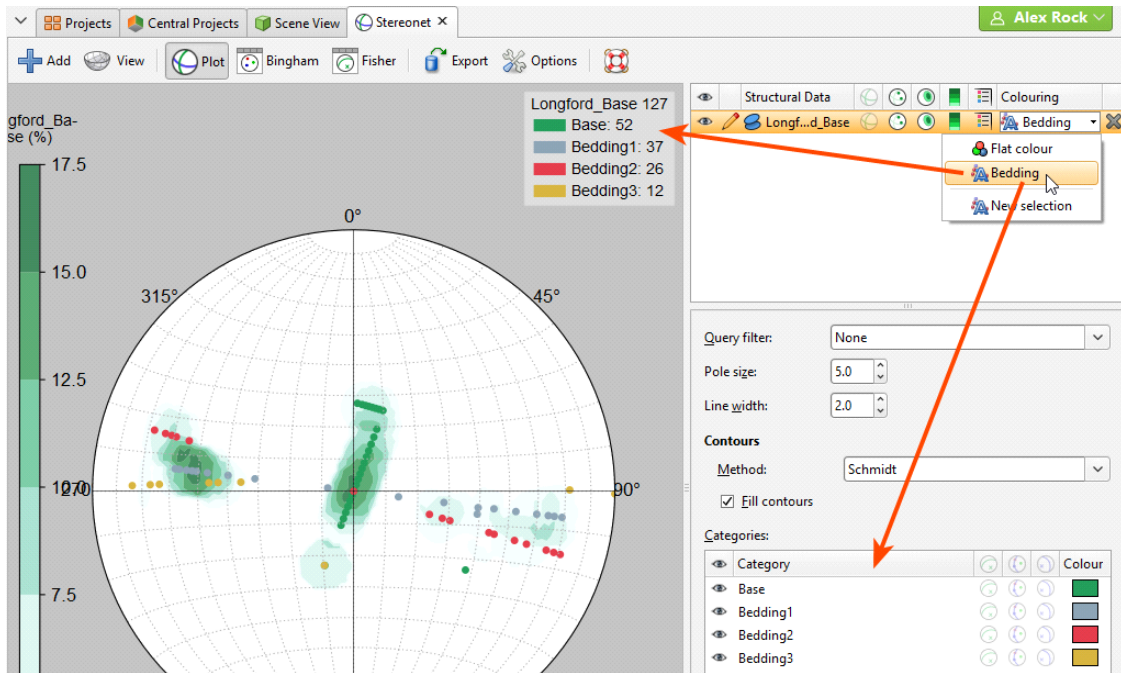

You can apply query filters from those available in the project.

Declustered data can be viewed on stereonets in two ways:

- Declustered data can be viewed directly on the stereonet. Simply drag the declustered table into the stereonet.
- If the declustered data's parent data table is displayed on the stereonet, the declustered data is available as a filter.

For example, here a structural data table is displayed on a stereonet along with a declustered table. The declustered table is available as a query filter for its parent object:

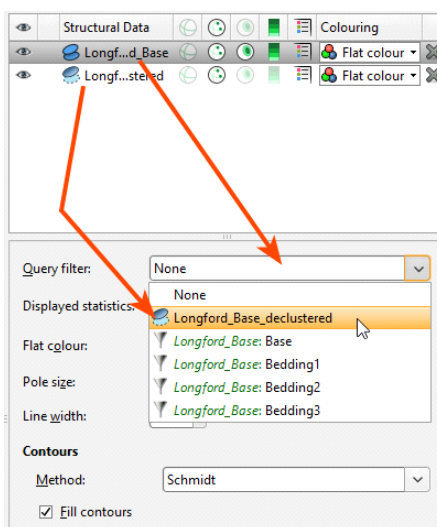

Viewing Stereonet Statistics

To view statistics on the data displayed on the stereonet, click either the **Bingham** button or the **Fisher** button:

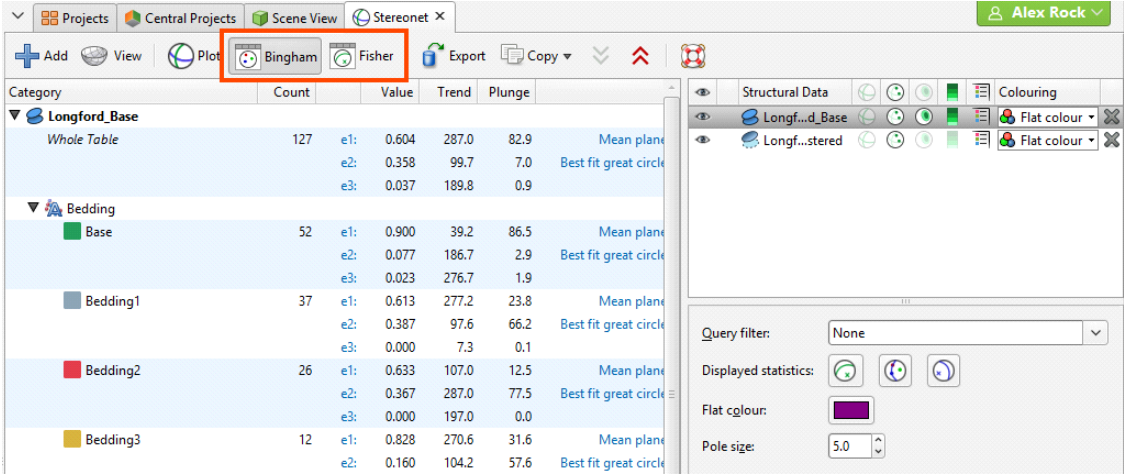

You can select specific rows and copy them to the clipboard or copy all data to the clipboard.

Selecting Data in the Stereonet

You can select data in the stereonet and assign it to new categories or existing ones. To do this, click on the data table in the stereonet window and select **New selection** from the colouring list:

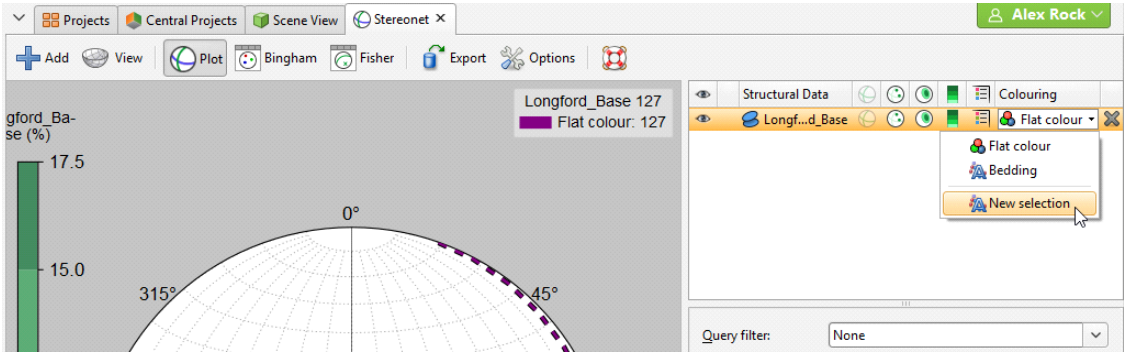

The **New Category Selection** window will appear:

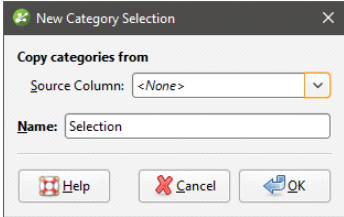

The poles will be displayed in the stereonet, if they are not already visible, and the data table will also be added to the scene window, together with tools for selecting points in the scene.

Organising the stereonet tab and the **Scene View** tab so they are displayed side-by-side can be useful in working with the data as you can select data in the stereonet or in the scene window. This is described further in [Using the Scene Window with the Stereonet](#) below.

If you select an existing column as the **Source Column**, you can assign selected points to the existing categories or create new categories. If you select **<None>** for the **Source Column**, you will have to define each category manually.

When you click **OK**, a set of tools for selecting data will be added to the stereonet window:

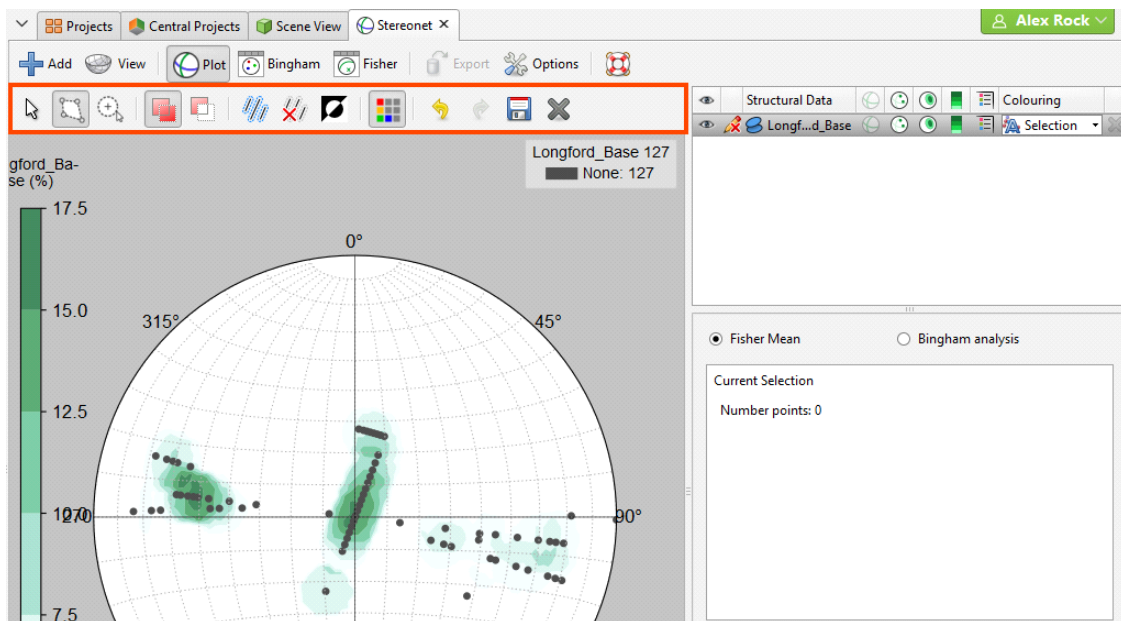

There are two tools for selecting data in the stereonet, the polygon tool (📐) and the bullseye (🎯) tool.

- Use the polygon tool (📐) to draw around the points you wish to select. Closing the polygon will select the points, and you can click on the vertices to refine the shape of the selection. Click outside of the selection to clear the polygon.
- Use the bullseye tool (🎯) to:
 - Click on points one-by-one.
 - Click and drag around points.

The **Add** button (📌) and the **Remove** button (🗑️) determine whether selected points are being added to or removed from the selection. For example, if you draw a polygon around a set of points with the **Add** button enabled, the points will be added to the selection.

You can also:

- Remove points from a selection while the **Add** button (📌) is enabled by holding down the Ctrl key and selecting points.
- Select all visible points by clicking on the **Select All** button (👤) or by pressing Ctrl+A.
- Clear all selected points by clicking on the **Clear Selection** button (🗑️) or by pressing Ctrl+Shift+A.

- Swap the selected points for the unselected points by clicking on the **Invert Selection** button (☒) or by pressing Ctrl+I.
- Show or hide all unassigned points using the **Unspecified Measurements** button (☐).

Statistics are shown for the currently selected set of points:

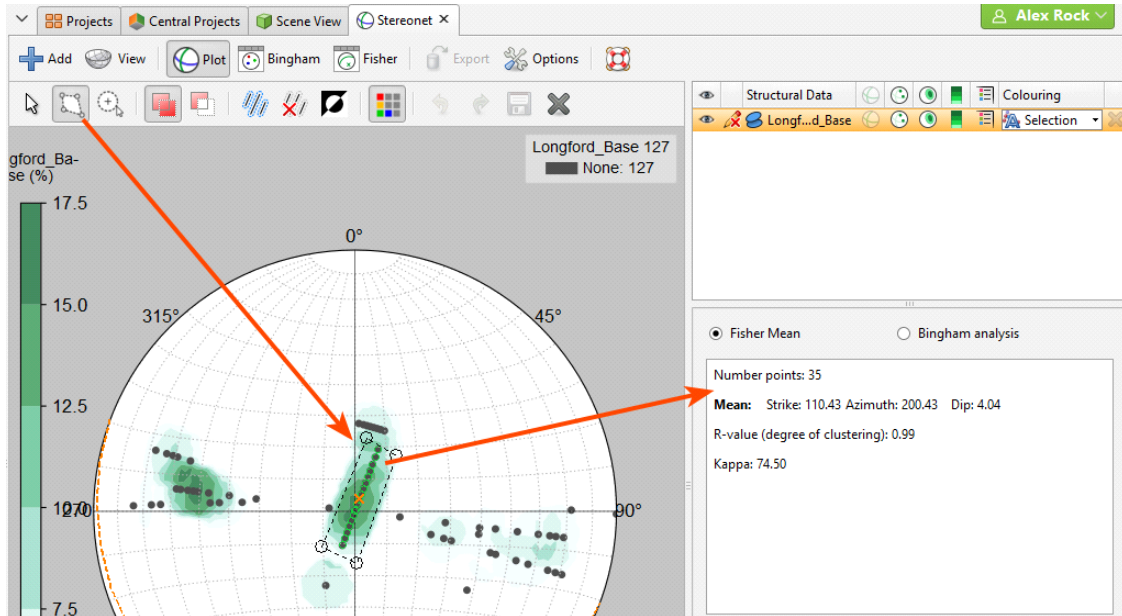

You can choose what type of statistics to display for selected points:

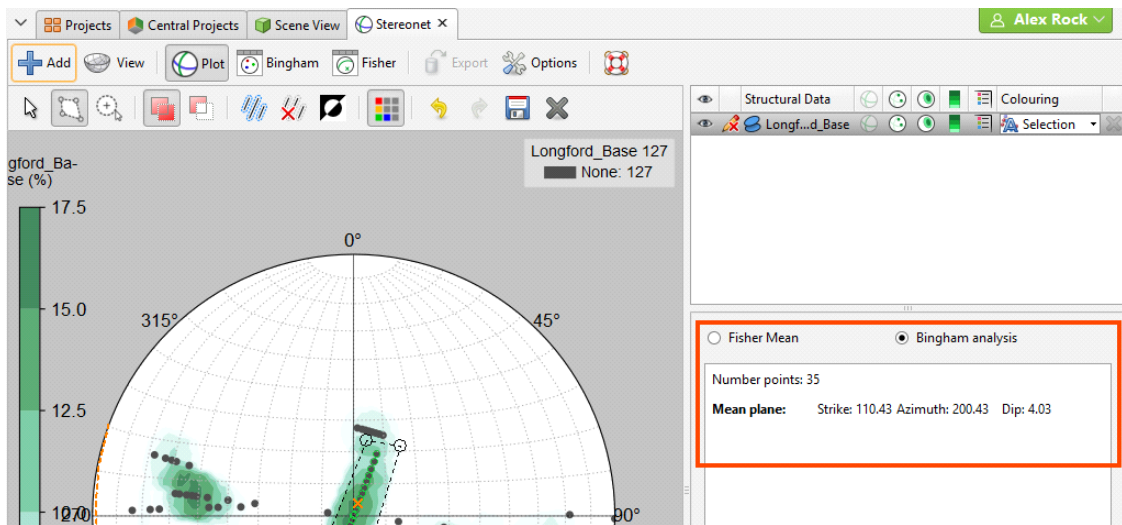

Once you have selected a set of points, click the **Assign to** button in the stereonet window, then select **Create New Category**. In the window that appears, enter a name for the category and assign a colour:

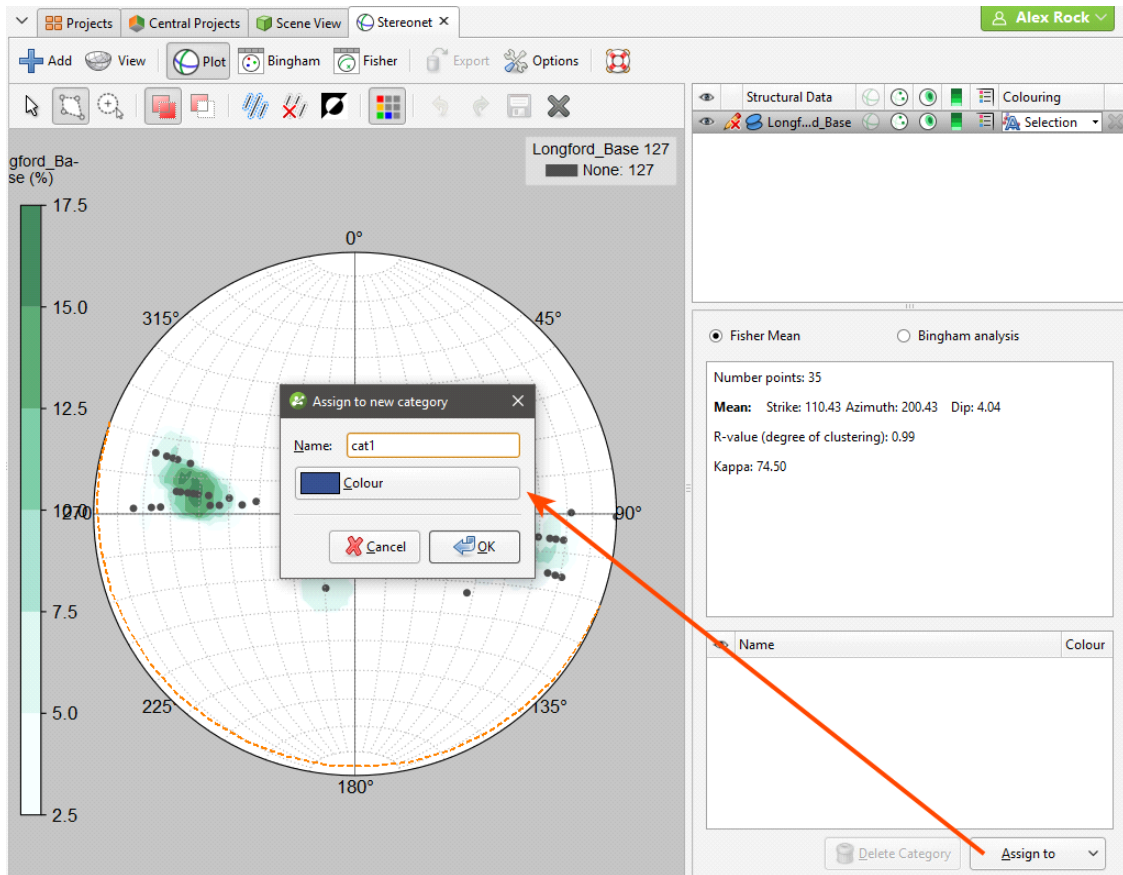

Click **OK**. The new category will be created and the stereonet will be updated to reflect the changes:

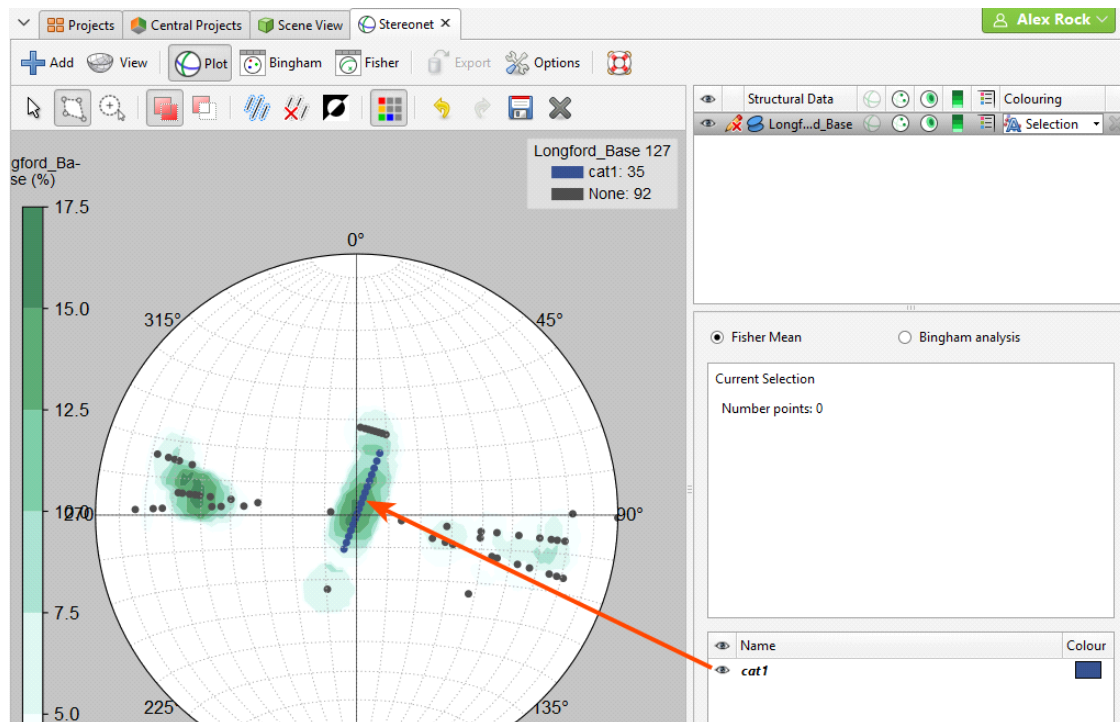

The scene window will also be updated.

Once you have created a new category, you can add to it by selecting further points, then selecting the category from the **Assign to** list.

When you are finished, click the **Save** button (📁) and close the category editor. You can make further edits by clicking the **Edit** button (✏️) in the stereonet window.

Using the Scene Window with the Stereonet

You can also select points in the scene window by clicking on the **Select points** tool () , then drawing over those points in the scene:

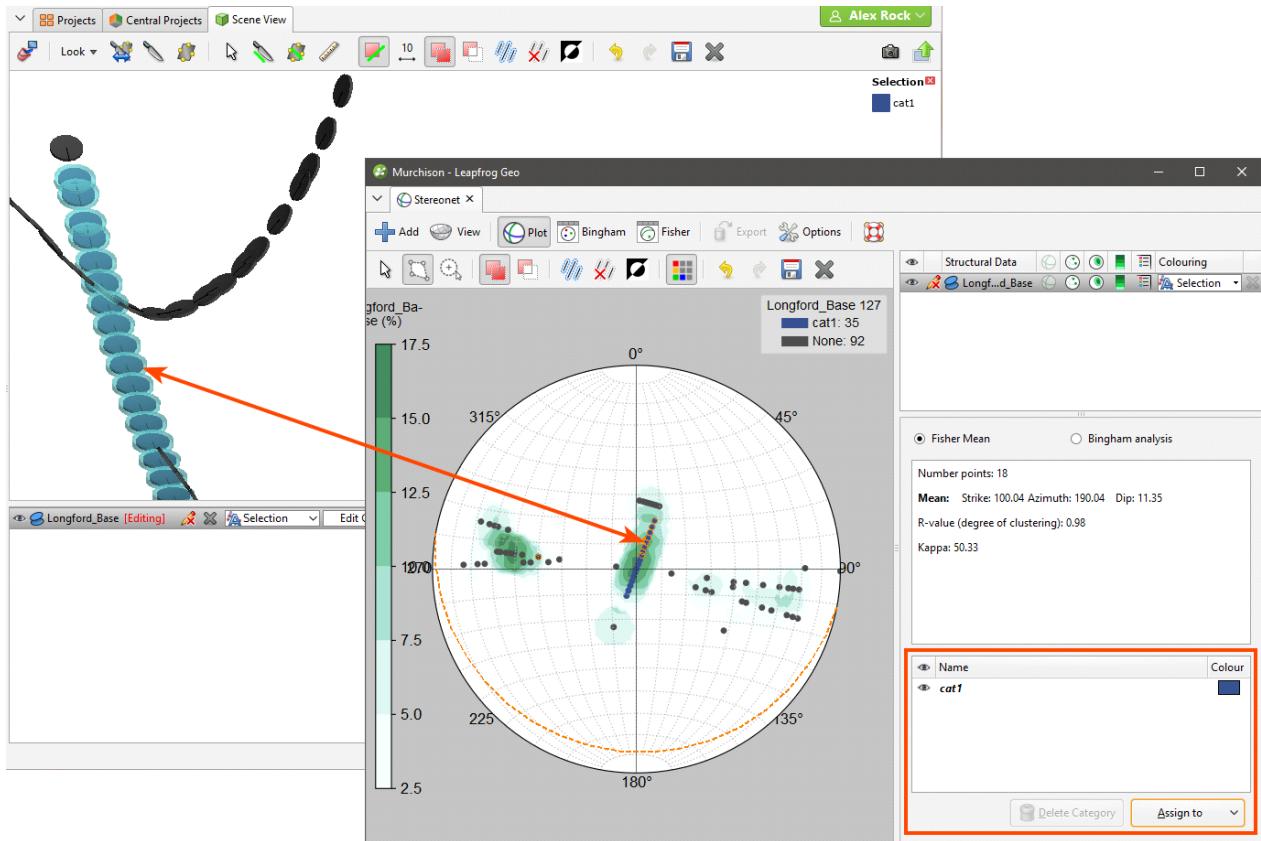

Controls for assigning points to categories will remain in the stereonet window, and both the stereonet window and the scene window will be updated to reflect the selected and assigned points.

Exporting a Stereonet

Stereonets can be exported in the following formats:

- PDF Files (*.pdf)
- Scalable Vector Graphics Files (*.svg)
- PNG Image Files (*.png)

Click the **Export** button. Select a format and navigate to the folder where you wish to save the file. Enter a name and click **Save**.

Form Interpolants

A form interpolant is an RBF interpolant that uses planar structural data to control the RBF gradient. The RBF gradient resembles the geology orientation, which makes form interpolants useful for visualising structural data and identifying broad trends in 3D. The form interpolant's meshes can then be used to control other surfaces in the project.

This topic describes how to work with form interpolants in Leapfrog Geo. It covers:

- [Creating a Form Interpolant](#)
- [The Form Interpolant in the Project Tree](#)
- [Form Interpolant Statistics](#)

Once a form interpolant has been created, experiment with different **Distance** values. To do this, double-click on the interpolant in the project tree and click on the **Outputs** tab.

Creating a Form Interpolant

To create a form interpolant, right-click on the **Form Interpolants** folder (in the **Structural Modelling** folder) and select **New Form Interpolant**. In the window that appears, click the **Add** button to add structural data tables to the interpolant:

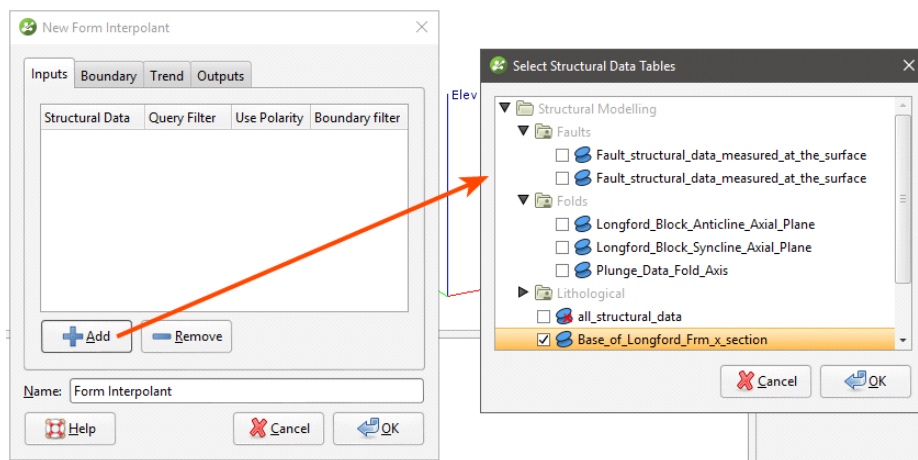

Data can be filtered using the query filters defined for the selected structural data tables:

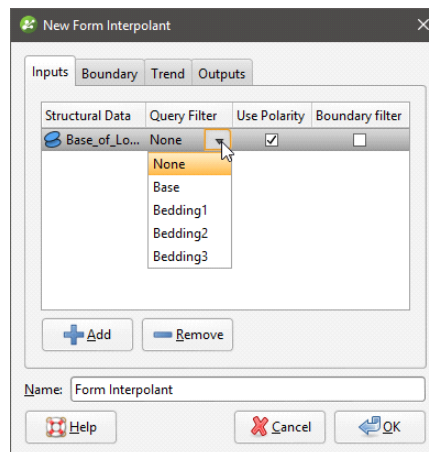

Once you have created the interpolant, you can easily add and remove structural data tables and change the filtering.

When generating the form interpolant, you can use the tangents and polarity or only the tangents. To use both, leave the **Use Polarity** box ticked. To use only the tangents, untick the box.

The **Boundary filter** setting determines how data is handled when it lies outside the interpolant's boundary:

- **Boundary filter** enabled. The interpolant is only influenced by the data that falls inside the boundary.
- **Boundary filter** disabled. The interpolant is influenced by the data both inside and outside the boundary.

Setting a Trend

In the **Trend** tab, you can set a trend using the moving plane or by entering the required values. You can also use the **Set to** list to choose different options used in the project. **Isotropic** is the default option used when the function is created.

The **Ellipsoid Ratios** determine the relative shape and strength of the ellipsoids in the scene, where:

- The **Maximum** value is the relative strength in the direction of the green line on the moving plane.
- The **Intermed.** value is the relative strength in the direction perpendicular to the green line on the moving plane.
- The **Minimum** value is the relative strength in the direction orthogonal to the plane.

Adding Isosurfaces

The isosurfaces generated for the form interpolant are determined by the settings in the **Outputs** tab. If you wish to add more isosurfaces to the interpolant, click the **Add** button and enter the required **Iso Value**. Click on an isosurface and then on the **Remove** button to delete it. The **Default resolution** setting is used for all new isosurfaces.

The Form Interpolant in the Project Tree

In the project tree, the form interpolant contains objects that represent different parts of the interpolant:

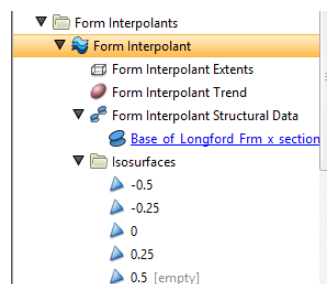

- The **Extents** object represents the interpolant's boundary settings, from the **Boundary** tab.
- The **Trend** object describes the trend applied in the interpolant. See [Global Trends](#) for more information.
- The structural data object (🔗) contains a link to the data used in generating the interpolant. See [Form Interpolant Statistics](#) for more information.
- The **Isosurfaces** folder contains the isosurfaces defined in the **Outputs** tab.

To display the form interpolant:

- Drag the interpolant into the scene.
- Right-click on the interpolant and select **View Isosurfaces**.

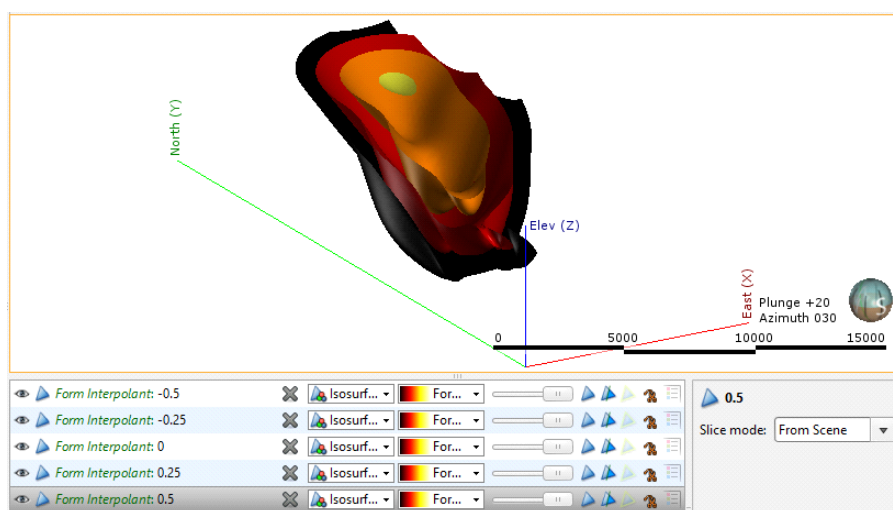

Form Interpolant Statistics

To view information about the data used for the form interpolant, right-click on the structural data object (📌) under the interpolant and select **Properties**. The **General** tab includes information about how the data has been declustered:

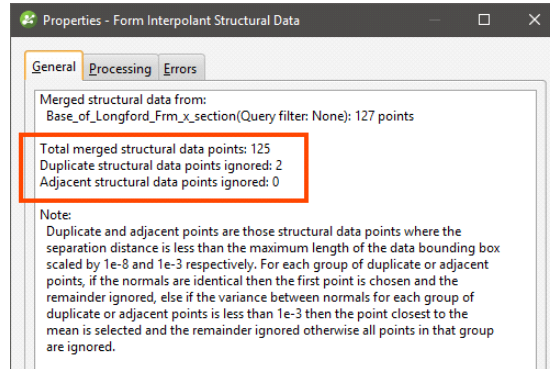

You cannot change how data is declustered in the form interpolant, but if you wish to have more control over this, create a declustered structural data set and use it as the input for the form interpolant. See [Declustering Planar Structural Data](#) for more information.

Planning Drillholes

In Leapfrog Geo, planned drillholes are organised into drillhole groups. You can evaluate models onto the drillhole group and view drilling prognoses for all drillholes in the group.

Planned drillhole groups were introduced in Leapfrog Geo 4.3. When a project from an earlier version is opened in Leapfrog Geo 4.3, all existing planned drillholes will automatically be assigned to groups, based on the phases of each drillhole.

If necessary, you can move planned drillholes between groups by opening both groups, then dragging drillholes between the groups. This copies drillholes from group to group, so once copied, you will need to delete the planned drillhole from the group it does not belong to.

Planned drillholes are added to a project from a drillhole group, and these are stored in the **Planned Drillholes** folder. When displayed in the scene, the planned drillhole is made up of a collar point, a target location and a path defined by lift and drift parameters:

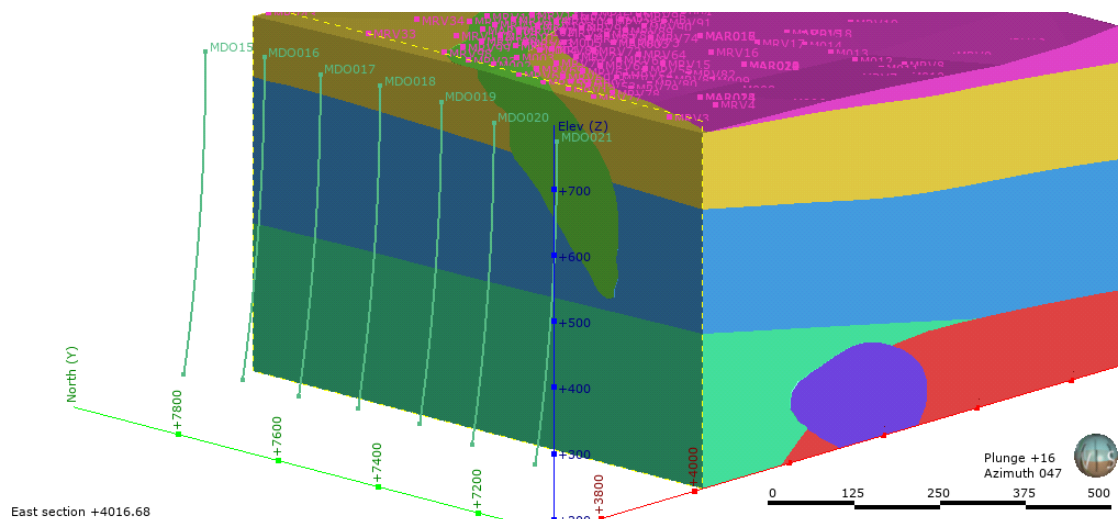

The rest of this topic is divided into:

- [Adding Planned Drillholes](#)
- [Planning Options](#)
- [Drilling Prognoses](#)
- [Exporting Planned Drillholes](#)
- [Importing Planned Drillholes](#)

Adding Planned Drillholes

To plan a drillhole, first add the data objects to the scene that you will use in helping to define the drillhole, such as the topography and any existing drillholes. Next, right click on the **Planned**

Drillholes folder and select **New Group**. In the window that appears, you can define basic information about the group, including the **Prefix** used for each drillhole added to the group:

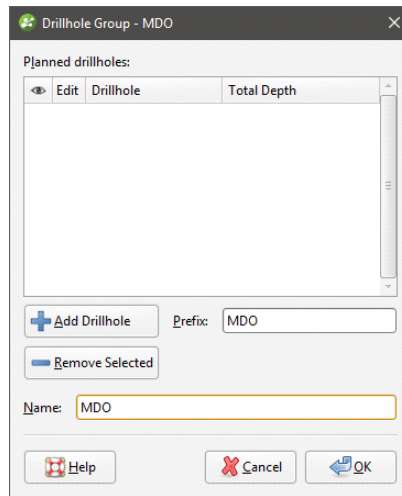

Start defining drillholes by clicking the **Add Drillhole** button.

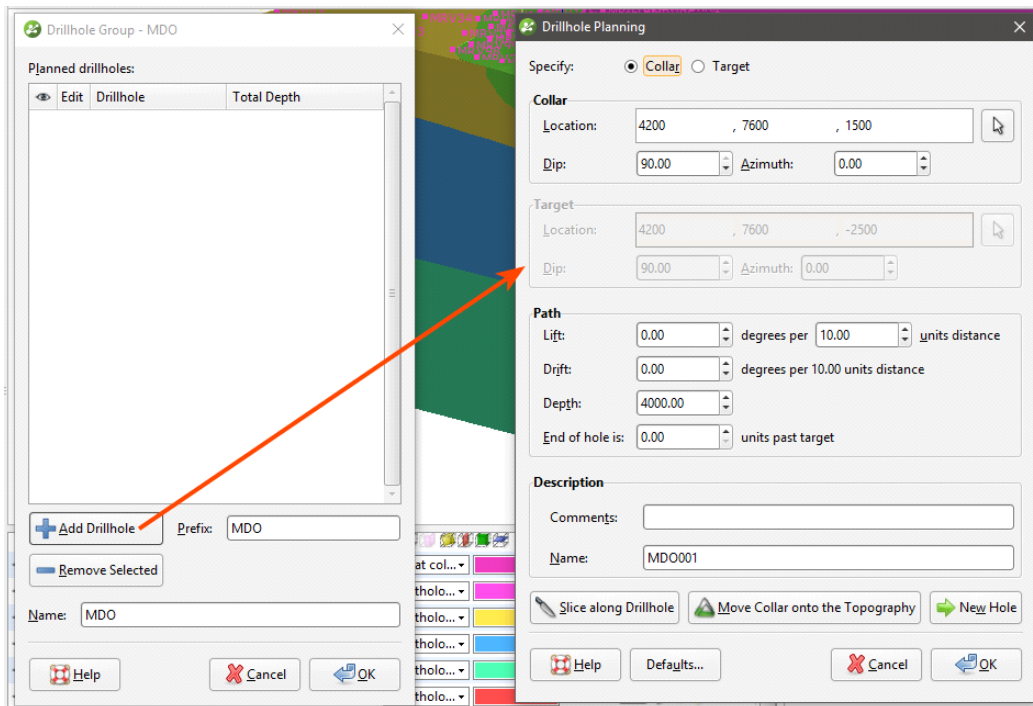

You can change whether **Collar** or **Target** is selected when this window is opened by clicking on the **Defaults** button. See [Planning Options](#) below.

A name is automatically generated for the new planned drillhole based on the **Prefix** defined for the group.

There are three ways to define the drillhole collar or target:

- Click in the scene to set the collar or target location. First, click on the **Select** button (📍) for the **Collar** or **Target**, then click in the scene to define the **Collar** or **Target**. The drillhole will appear in the scene and you can adjust the coordinates using the controls in the **Drillhole**

Planning window. Click the **Slice along drillhole** button to draw a slice in the scene. This is useful in adjusting the drillhole path and in defining subsequent drillholes.

- Draw the drillhole in the scene. Click on the **Select** button (👁) for the **Collar** or **Target**, then click and drag in the scene to define a basic path for the drillhole. If you are defining the drillhole from the collar down, click first on or near the topography. Likewise, if you are defining the drillhole from the target up, click first at or near the target point.
- Enter the coordinates for the **Collar** or the **Target** in the **Drillhole Planning** window.

Clicking the **Move Collar onto the Topography** button adjusts the elevation of the drillhole so that it lies on the topography.

Click the **Next Hole** button to create another planned drillhole. The new planned drillhole will be created at a specific distance from the currently displayed planned drillhole using the **Path** settings for the currently displayed drillhole and the **Offset To Next Hole** settings in the **Drillhole Planning Options** window. See [Planning Options](#) below.

Once you have specified the collar or target, adjust the drillhole path:

- **Lift** is how much the drillhole deviates upward.
- **Drift** is how much the drillhole deviates laterally.
- Leapfrog Geo automatically calculates the **Depth** value when the drillhole is defined by the **Target** location.
- Adding an **End of hole** length extends the drillhole past the **Target** location.

Once you have finished defining planned drillholes, click **OK** to return to the **Drillhole Group** window.

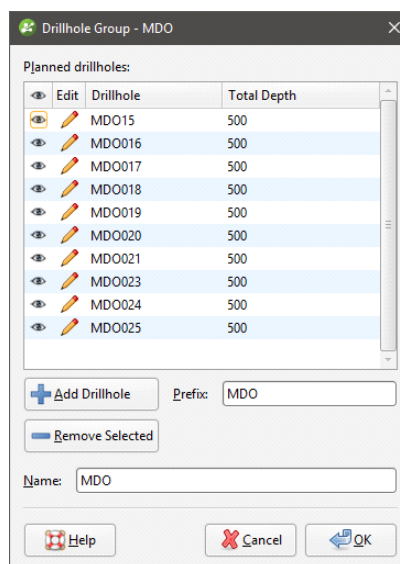

You can change the automatically generated name by clicking on the drillhole in the list and editing the text.

Search for planned drillholes in the list by pressing Ctrl-F. A **Find** window will appear that you can use to search the list.

Click the **Edit** button (✏️) to change the settings for a planned drillhole, or click **OK** to save the group.

Any model in project can be evaluated on a drillhole group, and evaluations can be exported when the group is exported as interval tables. See [Exporting Planned Drillholes](#) below. Right-click on the group in the project tree and select **Evaluations**. The **Sample Distance** setting applies to numeric evaluations and determines the spacing between downhole evaluation points.

You can also define filters for a drillhole group. A filter makes it easier to select a subset of the drillhole when the group is displayed in the scene. To define a filter, right-click on the group and select **New Filter**. Select which drillholes to include in the filter and enter a name for it. The filter will be saved in the project tree as part of the group.

Display planned drillhole by dragging the group into the scene. Hide drillholes in the scene using any defined filters or by opening the group and using the show/hide button (👁️).

You can copy planned drillholes between groups by opening both groups, then dragging drillholes between the groups. For example, here the drillholes selected in the first group are being copied into the second group:

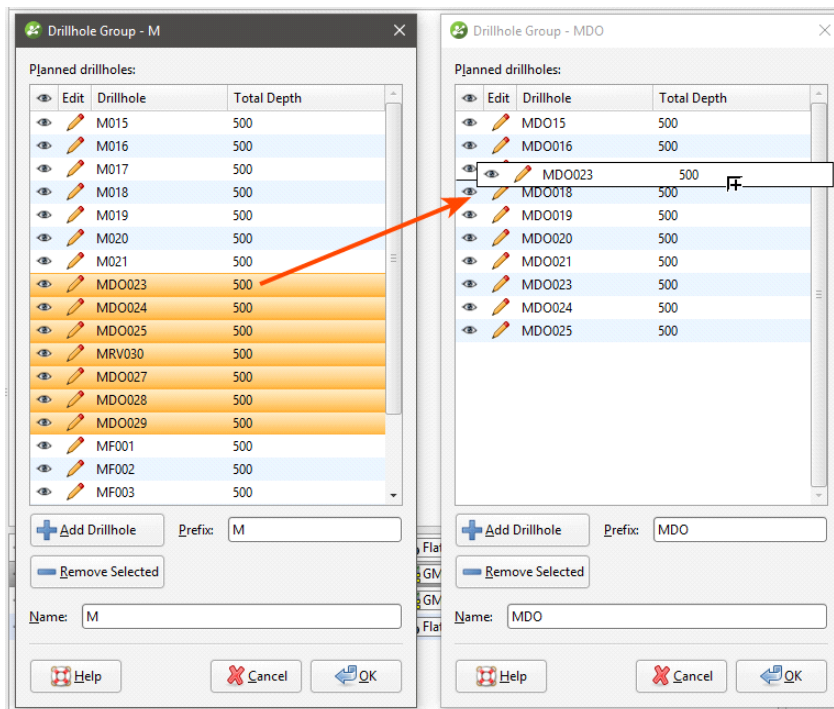

This copies drillholes from group to group, rather than moving them, so once copied, you will need to delete the planned drillhole from the group it does not belong to.

Planning Options

Drillhole planning options are set on a per-project basis. To change drillhole planning options, right-click on the **Planned Drillholes** folder or on a drillhole group and select **Edit Planned Drillholes Defaults**. The **Drillhole Planning Options** window will appear:

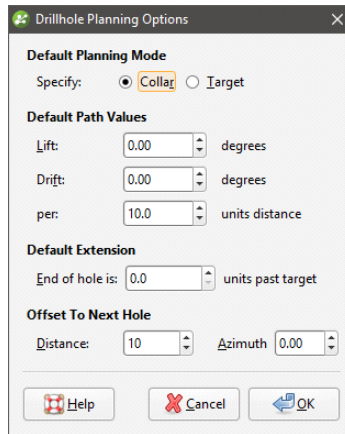

Select whether new planned drillholes are specified by the **Collar** or by the **Target**.

The **Offset To Next Hole** values apply when defining multiple drillholes in the **Drillhole Planning** window.

Enter the information required and click **OK**. The new settings will be applied to the next new planned drillhole added to the project.

Drilling Prognoses

Planned drillholes can be evaluated against any model in the project. To view drilling prognoses for a drillhole, right-click on a drillhole group in the project tree and select **Drilling Prognoses**. The **Drilling Prognoses** tab will appear:

The screenshot shows the 'Drilling Prognoses: MDO' window with a dropdown menu set to 'Merged Intervals'. The table below displays the data:

Name	From	To	Au	GM
MDO15	0.0	2.0	-0.218703968889	D
MDO15	2.0	4.0	-0.219261480827	D
MDO15	4.0	6.0	-0.219825829703	D
MDO15	6.0	8.0	-0.220397151236	D
MDO15	8.0	10.0	-0.220975573909	D
MDO15	10.0	12.0	-0.221561218817	D
MDO15	12.0	14.0	-0.222154199513	D
MDO15	14.0	15.194	-0.222754621814	D
MDO15	15.194	16.0	-0.222754621814	C
MDO15	16.0	18.0	-0.223362583711	C
MDO15	18.0	20.0	-0.223978175178	C

The dropdown list contains all evaluations on the drillhole group, along with a **Merged Intervals** option that combines the information from all evaluations. You can copy the information displayed to your computer's clipboard by selecting rows, then clicking the **Copy** button (📄). The information in the selected rows will be copied as tab delimited text, which can be copied into a spreadsheet application such as Excel.

Exporting Planned Drillholes

There are two ways to export planned drillholes: export their parameters or export interval tables that contain the drillholes.

Export Parameters

Exporting planned drillhole parameters exports the drillholes as a *.csv file. To export parameters for planned drillholes, right-click on a drillhole group and select **Export Parameters**. In the window that appears, select the drillholes you want to export. The total length will be updated as you add or remove drillholes.

In Leapfrog Geo, positive dip points down for planned drillholes. To invert the dip for exported planned drillholes so that negative dip points down, tick the box for **Invert dip on export**.

Click **Export**. Navigate to where you wish to save the file, then click **Save**.

Export as Interval Table

To export planned drillholes as an interval table, right-click on a drillhole group and select **Export as Interval Table**. Select the evaluations you wish to include, then click **Export**. In the **Export Planned Drillholes** window, the files that will be created are listed, one each for the collar and survey table and one for each selected evaluation. Change the **Base file name**, if required, choose a folder in which to save the files, then click **Export** to save the files.

Importing Planned Drillholes

Leapfrog Geo imports planned drillholes from files in CSV format. The columns expected are:

- A drillhole identifier
- X-Y-Z coordinates for the planned drillhole
- Azimuth
- Dip
- Lift rate
- Drift rate
- Distance
- Extension
- Target Depth
- Comment

When importing planned drillholes, you can import them into a new group or into an existing group. To import planned drillholes, right-click on the **Planned Drillholes** folder or on a group and select **Import Planned Drillholes**. If the IDs in the file are already in the project, you will be prompted to resolve the conflict:

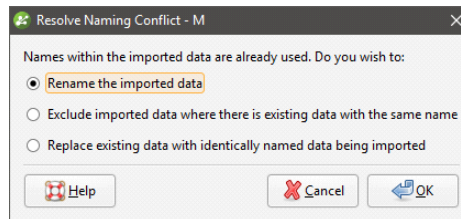

You can:

- Rename the imported drillholes. Leapfrog Geo will automatically assign new names and import the planned drillholes.
- Exclude planned drillholes that already exist in the project. Planned drillholes will only be imported if they have an identifier that does not already exist in the project.
- Replace existing planned drillholes with the imported drillholes. Use this option if you are importing information previously exported from the project and subsequently updated in an external application.

Click **OK** to process the file.

If there are no conflicts, the planned drillholes will be added to the project.

Modelling

This section describes how to build models in Leapfrog Geo.

- Geological models can be built from lithology data or from any other suitable data in the project. Visualising data in the scene is an important step in determining the model that will be built, and the tools for doing this are described in [Visualising Data](#). Once this has been determined, the next step is to define a basic geological model and refine its boundaries. Modelling contact surfaces and setting their cutting relationships determine how the basic model volume is divided into lithologies. Models can also have a fault system that, once activated, will subdivide the model into fault blocks.
- With the **Numeric Models** folder, you can interpolate downhole numeric data, composited drillhole data and points data.
- Combined models use information from up to four geological models, interpolants and distance functions in order to visualise relationships between different types of data in the project.
- When you have a licence for the Hydrogeology module, geological models created in Leapfrog Geo can be used as the basis for MODFLOW and FEFLOW models. You can create flow models directly in Leapfrog Geo and assign hydrological/material properties based on the lithologies in the geological model. Flow models can be exported for use in other applications, and you can import existing flow models and use them as the basis for the construction of new models. Flow models can be displayed in the scene, and time-dependent data can also be visualised.
- Leapfrog Geo can import Isatis files, UBC grids and block models in CSV format. Leapfrog Geo can import Isatis files and block models in CSV format. Block models imported in CSV format must be regular, rotated only about the Z axis. Block models and sub-blocked models can also be created directly in Leapfrog Geo and exported for use in other applications. Creating block models within Leapfrog Geo has the advantage that the resolution can easily be changed. Geological models and interpolants can be evaluated on block models, as described in [Evaluations](#) below.

Evaluations

In Leapfrog Geo, models can be evaluated onto other objects in the project. To do this, right-click on an object and select **Evaluations**:

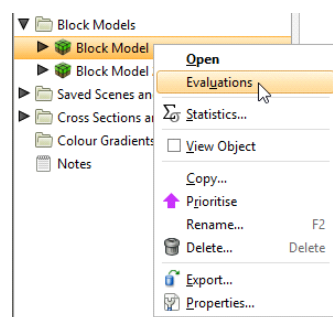

See [Back-Flagging Drillhole Data](#) for information on evaluating drillholes on geological models.

See [Evaluating on Sections](#) for information on evaluating surfaces on cross sections and fence sections.

See [Evaluating Points Data](#) for information on evaluating surfaces on points.

A window will appear listing all objects in the project that can be used for an evaluation. Once you have selected one or more objects, click **OK**.

The evaluations will be added to the object in the project tree:

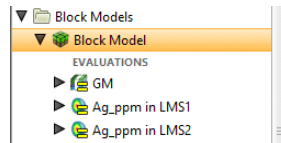

When you display objects in the scene, you can select the evaluations from the view list:

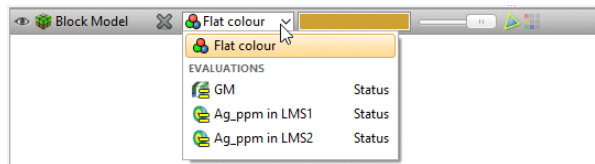

Assigning Attributes to Volumes

For geological models, numeric models and combined models, you can assign attributes to the model volumes. To do this, right-click on the model in the project tree and select **Volume Attributes**. In the window that appears, click the **Add Attribute** button to add a new column.

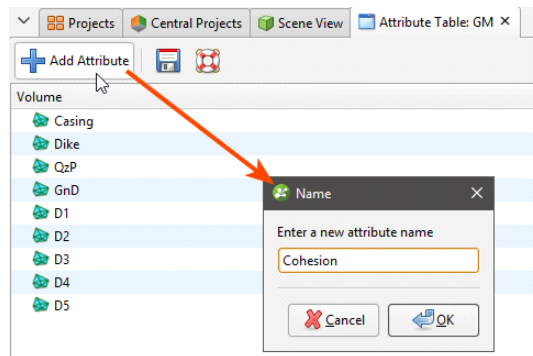

Enter a name for the column and click **OK**. You can then edit the values in the table. When you click in the scene, the values will be included in the information displayed about the selected volume:

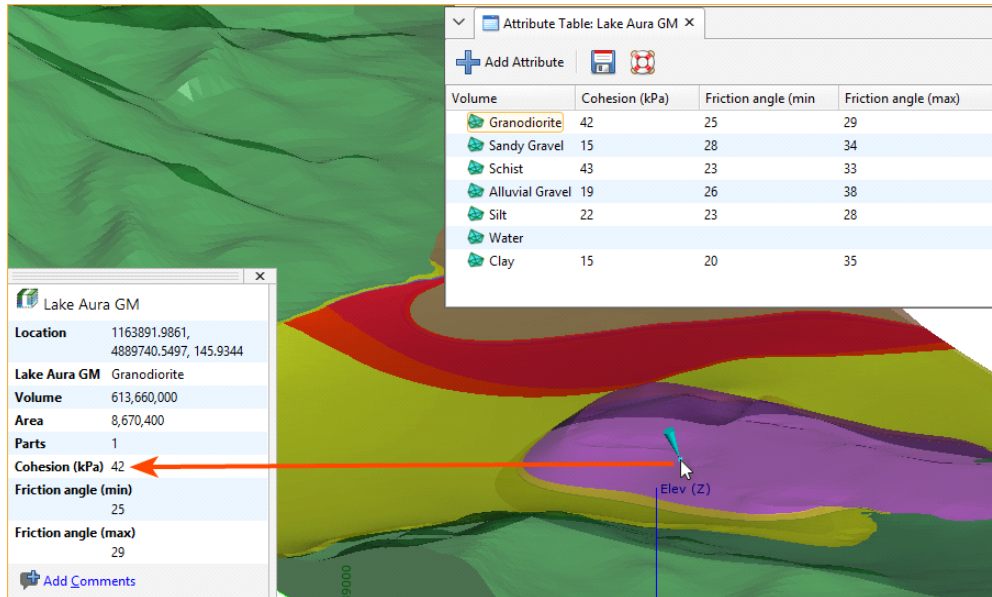

Attribute information cannot be displayed in the Central Browser.

When you save scenes for viewing in Leapfrog Viewer, manually entered attributes will be displayed when volume information is displayed.

Geological Models

The model building process involves several key steps:

- Creating the project and setting up the modelling environment
- Importing drillhole data and correcting errors
- Importing other required data
- Visualising the data in the scene and inspecting it to make sense of the model that will be built. It is at this stage that you might create new drillhole data columns to select data that will be the basis of geological models.
- Creating a basic GM, then refining its boundary and defining a fault system
- Modelling the contact surfaces
- Setting the cutting relationships between the different contact surfaces and generating volumes

A fault system can also be defined that divides the geological model into subunits in which the internal structure can be defined independent of the other subunits in the model. This is described in [Faulted Models](#).

The rest of this topic describes the process of creating a geological model. It is divided into:

- [Creating a New Geological Model](#)
- [The Geological Model in the Project Tree](#)
- [Geological Model Display](#)
- [Copying a Geological Model](#)
- [Creating a Static Copy of a Geological Model](#)
- [Geological Model Volumes and Surfaces Export Options](#)
- [Extracting Model Volumes](#)

A geological model can be created using only a basic set of parameters. The only parameter that cannot be changed once the model has been created is the base lithology.

Creating a New Geological Model

To create a new geological model, right-click on the **Geological Models** folder and select **New Geological Model**. The **New Geological Model** window will open, together with a set of controls in the scene that help in defining the model extents.

The Base Lithology

Select the drillhole data column that will be used as the basis of a model from the **Base Lithology Column** list. If you do not wish to use lithology data as the basis for the model, select **<None>**. This may be the case if, for example, you want to build a model from points data or

from an imported map. If you select **<None>**, you will need to manually define the lithologies that will be modelled.

If more than one column of lithology data is available for creating models, be sure to choose the correct one as it cannot be changed once the initial model has been created. If after creating and modifying the model, you find you need to modify the drillhole data, resulting in a new lithology column, you can use that new column to create contact surfaces using **Other Contacts** options.

You can also filter the drillhole data used to build the geological model using query filters. To do so, select the required query filter from the **Filter data** list. Once the model has been created, you can remove the filter or select a different filter.

Surface Resolution

The surface resolution setting Leapfrog Geo automatically uses as the default is based on the data available in the project. Set the surface resolution for the model as a whole and choose whether or not the resolution will be adaptive. See [Surface Resolution in Leapfrog Geo](#) for more information on the effects of these settings.

Later, while refining the model, you can change the resolution of each surface and enable or disable adaptive resolution. See [Surface Resolution for a Geological Model](#).

Model Extents

A geological model is initially created with a basic rectangular set of extents aligned with the south/north and east/west axes. You can define the model's extents in three ways:

- Enter the coordinates.
- Select **Enclose Object** and choose from the list of objects in the project. If the model is based on drillhole data, select the lithology segments from the **Enclose Object** list.
- Use the controls that appear in the scene. The orange handle adjusts the centre of the plane and the red handles adjust the size.

See [Object Extents](#) for more information.

Enter a **Name** for the model that describes the purpose of the model. This **Name** will be used in naming the objects that will be added to the model. Click **OK** to create the new model. The new geological model will be created and added to the **Geological Models** folder.

See [Editing a Geological Model](#) for information on how to change the basic settings for the model.

The Geological Model in the Project Tree

The objects under the geological model in the project tree represent different parts of the model:

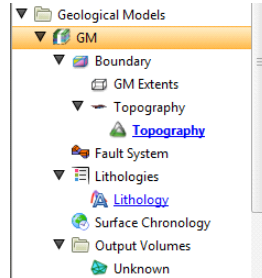

- The **Boundary** object defines the limits of the geological model. When the model is first created, this is the rectangular model extents. If a topography has been defined, it is automatically used for as the upper boundary. See [Modifying a Geological Model's Boundary](#) for more information about modifying the boundary.
- The **Fault System** object defines faults and their interactions in the model. See [Faulted Models](#).
- The **Lithologies** object describes all the lithological units to be modelled and the colours that are used to display them on the screen. It is generated automatically from all the lithologies identified in drillhole data selected when the model is created. If no column was selected, you will need to define the lithologies manually before you start modelling the lithology layers.
- The **Surface Chronology** object describes the contact surfaces in the model, organised in chronological order, from youngest to oldest. These surfaces and their chronology determine how the volume inside the model extents is divided into lithological units. When the model is first created, the **Surface Chronology** is empty, but it will eventually hold all contact surfaces and inputs to them.
- The **Output Volumes** folder contains all the volumes generated in building the geological model. When the model is first created, the **Surface Chronology** is empty and so there is only a single output volume in the **Output Volumes** folder. This volume fills the model's extents and is called "Unknown". Once contact surfaces have been generated and added to the **Surface Chronology** object, new volumes will be generated and added to the **Output Volumes** folder.

Geological Model Display

Right-click on the geological model in the project tree to view its display options:

- The **View Object** option adds the geological model to the shape list as a single object. You can also display the geological model in this way by dragging it from the project tree into the scene. Change the visibility of the model's volumes by clicking the **Edit Colours** button in the shape list.

- The **View Output Volumes** option adds the model to the scene as a series of output volumes. It is the equivalent of dragging the **Output Volumes** folder into the scene. Change the visibility of the model's volumes individually.
- The **View Surface Chronology** option displays the surfaces that are used to divided up the model.
- The **View Fault Block Boundaries** option is only available when a fault system has been defined and enabled for the model. Selecting **View Fault Block Boundaries** displays the fault blocks without displaying the lithology layers.

Copying a Geological Model

Creating a copy of a geological model is a useful way of experimenting with changes to a model.

To copy a geological model, right-click on it in the project tree and select **Copy**. Enter a name for the copy of the model and click **OK**. The copy will be added to the project tree.

Creating a Static Copy of a Geological Model

Creating a static copy preserves a snapshot of a geological model that does not change, even when changes are made to the data on which the original model was dependent. This is a useful way of storing historical models and comparing models. Static copies can be exported from Leapfrog Geo, as described in [Geological Model Volumes and Surfaces Export Options](#) below.

To create a static copy of a geological model, right-click on it in the project tree and select **Static Copy**. Enter a name for the copy of the model and click **OK**. The copy will be added to the **Geological Models** folder.

In the project tree, the static copy (🌐) is made up of a **Legend** object (📄), the output volumes (🌐) and all surfaces created in building the model.

Static models created in versions of Leapfrog Geo before 2.2 copied only the output volumes and the legend, and the static model appeared in the shape list only as a single line. When these static models are upgraded and displayed in the scene, the individual output volumes will be added to the shape list.

To view the date a static copy was created, right-click on it in the project tree and select **Properties**. The date the copy was created is shown in the **General** tab.

Geological Model Volumes and Surfaces Export Options

There are three options for exporting a geological model's output volumes and surfaces. These are:

- Export an output volume or a surface as a mesh. Right-click on it in the project tree and click **Export**. You will be prompted for a file name and location. See [Exporting a Single Mesh](#).

- Export an output volume as a thickness grid. Right-click on it in the project tree and click **Export Thickness Grid**. See [Thickness Grids](#).
- Export multiple output volumes and surfaces. Right-click on the geological model in the project tree and select **Export**. See [Exporting Multiple Meshes from Models](#).

When exporting output volumes, the **Merge output lithology volumes** setting in the geological model's **General** tab (see [Editing a Geological Model](#)) determines how the output volumes are handled when they are exported. If this setting is enabled, internal walls and surface seams will be removed from volumes of the same lithology.

Extracting Model Volumes

There are number of options for extracting meshes from geological model output volumes. These options are available by right-clicking on volumes in the **Output Volumes** folder and selecting **Extract Mesh**. There are five options:

- **Mesh Parts**
- **Component Surfaces**
- **Younger Surfaces**
- **Older Surfaces**
- **Boundary Surfaces**

The **Mesh Parts** option is the same as the option available on meshes elsewhere in the project. See [Extracting Mesh Parts](#).

The **Younger Surfaces**, **Older Surfaces** and **Boundary Surfaces** options extract different parts of the selected volume, which are saved into the **Meshes** folder. Here, the boundary surfaces are shown in blue, the younger surfaces in yellow and the older surfaces in purple:

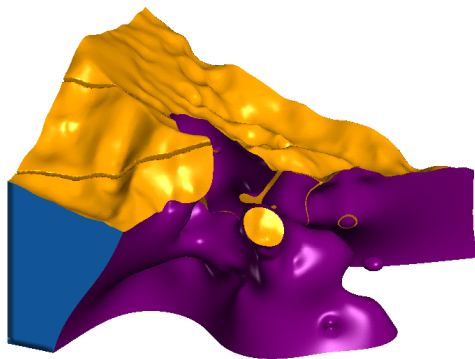

Component Surfaces extracts a separate surface for each volume the selected volume interacts with, including the boundary. The component surfaces are named after the boundary they are derived from and saved into a subfolder in the **Meshes** folder. For example, here meshes have been extracted for each contact with the Intermineral diorite volume:

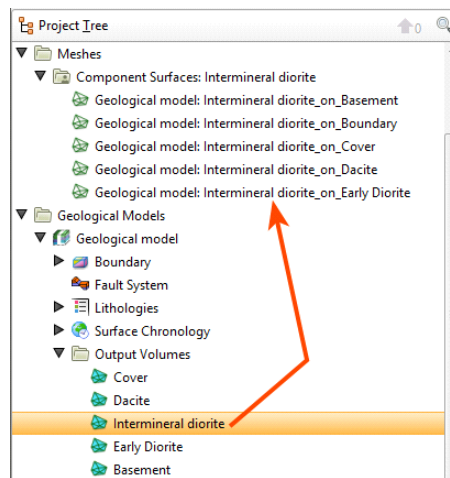

Editing a Geological Model

Once a geological model has been created, you can change the model's resolution and other basic settings by double-clicking on the model in the project tree. The **Geological Model** window will open with the **General** tab selected. The other tabs in the **Geological Model** window represent the different parts of the geological model. It is generally more useful, however, to work with these parts of the model on an individual basis by either double-clicking on the object in the project tree or right-clicking and seeing what options are available.

The rest of this topic describes how to change the basic settings for a geological model. It is divided into:

- [Changing the Query Filter](#)
- [Surface Generation Options](#)
- [Volume Generation Options](#)

Changing the Query Filter

Although the **Base lithology column** cannot be changed once a geological model has been created, you can change the filters applied to the data. Any filters defined for the lithology table used to define the model can be applied to the **Base lithology column**:

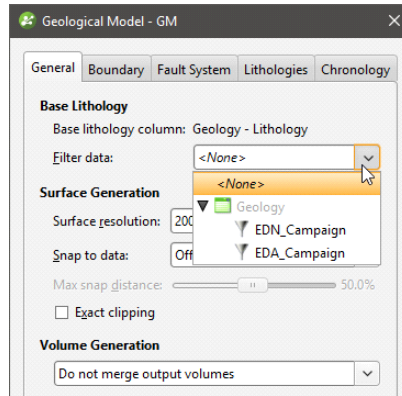

Individual surfaces in the geological model can inherit the query filter from the parent geological model or can use a different filter. To change what query filter is used for a surface, double-click on the points used to create the surface and change the **Query filter** setting in the **Lithology** tab:

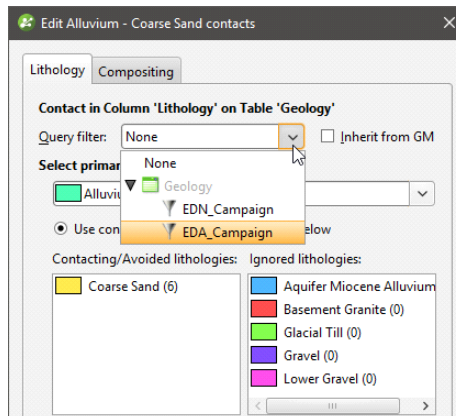

You may first need to disable the **Inherit from GM** option to change the **Query filter**.

Surface Generation Options

The **Surface Generation** options apply to the model as whole, but can be overridden for individual surfaces.

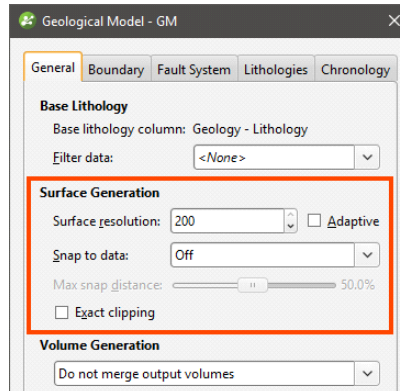

See [Surface Resolution for a Geological Model](#) for information on changing the **Surface resolution** and **Adaptive** settings for individual surfaces.

When **Exact clipping** is enabled, model surfaces will be generated without “tags” that overhang the model boundary. This setting is enabled by default when you create geological model.

Surfaces created in building the geological model can be set to snap to the data used in the model. There are three options:

- **Off.** Surfaces do not snap to the data used to create them.
- **All data.** Surfaces snap to all data within the **Maximum snap distance**, which includes drillhole data and any data added to surfaces as part of the model refinement process.
- **Drilling only.** Surfaces snap to drillhole data within the **Maximum snap distance** but not to other data used to modify surfaces.

Take care in enabling snapping and in selecting what data the surface will snap to, as the more data you include, e.g. by setting a large **Maximum snap distance** or selecting **All data** for **Snap to data**, the greater the possibility that errors in the data or assumptions inherent in interpretations (e.g. polylines) will cause distortions in the meshes. If you do enable snapping, it is best to snap only to drilling data. See [Honouring Surface Contacts](#) for more information on these settings.

If you need surfaces to honour drillhole data but treat other data objects as interpretations, select **Drilling only**. If you want finer control over what objects are snapped to, you can do this on a surface-by-surface basis. See:

- [Surfacing Options for Deposits and Erosions](#)
- [Surfacing Options for Intrusions](#)
- [Surfacing Options for Veins](#)
- [Changing Surfacing Options for an Offset Surface](#)
- [Surfacing Options for a Structural Surface](#)

Volume Generation Options

The **Merge output volumes** setting determines whether or not output volumes of the same lithology are merged when the volumes are exported. If **Merge output volumes** is set to **Fast** or **Robust**, internal walls and surface seams will be removed from volumes of the same lithology. Either option is suitable when you are using output volumes as extents for other models.

The difference between **Fast** and **Robust** is the algorithm used:

- **Fast** removes back-to-back triangles before generating output volumes. This option was new in Leapfrog Geo version 4.0 and is the default option selected when a geological model is created.
- **Robust** is the **Merge output lithology volumes** option from versions of Leapfrog Geo before 4.0. **Robust** uses the volume cutter, which tracks where the triangles originated and is, therefore, a slow option for building output volumes.

If there are issues with surfaces exported to other modelling packages using the **Do not merge output volumes** setting, try the **Fast** setting. If there are still issues, try the **Robust** setting.

When projects created in earlier versions of Leapfrog Geo are opened in Leapfrog Geo 4.5, the **Volume Generation** setting for any existing geological models will not be changed.

Surface Resolution for a Geological Model

When you create a geological model (see [Creating a New Geological Model](#)), the surface resolution is set for the model as a whole. When surfaces and boundaries are created as part of the model-building process, their resolution is inherited from the geological model:

- For deposit and erosion contact surfaces, stratigraphic sequences and model boundaries, the resolution is the same as the geological model.
- For intrusion contact surfaces, the resolution is half that set for the geological model.
- For vein contact surfaces, the resolution is the same as the geological model, but the **Adaptive** option does not apply.

You can change the resolution and enable or disable the adaptive isosurfacers on a surface-by-surface basis. This is useful if you want to build a detailed model of some lithologies without increasing processing time for other volumes.

To change the resolution settings for a contact surface, double-click on the surface in the project tree, then click on the **Surfacing** tab:

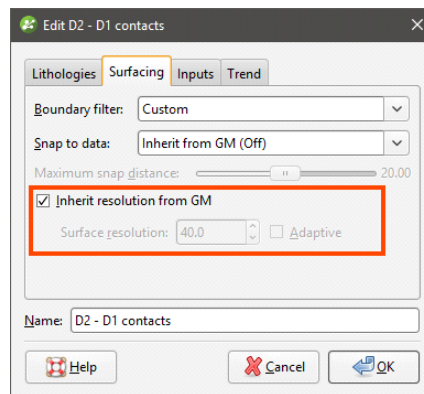

For a lateral extent or fault, simply double-click on the surface in the project tree to change its resolution settings.

Untick the **Inherit resolution from GM** box to change the resolution settings for a surface. This setting may be disabled, depending on the data used to create the boundary or surface.

The resolution of intrusion contact surfaces is also affected by the point generation parameters. See [Intrusion Point Generation Parameters](#) for more information.

Modifying a Geological Model's Boundary

Geological models are created with a basic set of rectangular extents that can then be refined using other data in the project. These extents usually correspond to the ground surface and known boundaries. Creating extents can also be used to restrict modelling to a particular area of interest; for example, modelling can be restricted to a known distance from drillholes by applying a distance function as a lateral extent. Extents do not need to be strictly vertical surfaces, and can be model volumes. It is also possible to define a base that serves as the geological model's base.

When a topography is defined for the project, it will be automatically applied as a geological model's upper boundary when the model is created.

The rest of this topic describes how to create and work with geological model extents. It is divided into:

- [Creating Extents for a Geological Model](#)
- [Changing an Extent's Settings](#)
- [Adding Data to an Extent](#)
- [Editing an Extent with a Polyline](#)
- [Editing an Extent with Structural Data](#)
- [Removing an Extent from a Geological Model](#)

Creating Extents for a Geological Model

To create an extent, expand the geological model in the project tree. Right-click on the **Boundary** object and select from the **New Lateral Extent** or **New Base** options. Follow the prompts to create the extent, which will then appear in the project tree under the model's **Boundary** object. For example, this geological model has two lateral extents, one from a polyline and the other from GIS data:

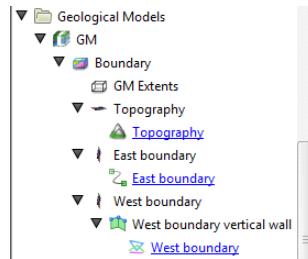

New extents are automatically applied to the boundary being modified. Leapfrog Geo usually orients a new extent correctly, with red presenting the inside face of the extent and blue representing the outside face. If this is not the case, you can change the orientation by right-clicking on the extent in the project tree and selecting **Swap Inside**.

Extent From a Polyline

You can create an extent from a polyline that already exists in the project or you can draw a new one. If you want to use an imported polyline, import it into the **Polylines** folder before creating the new extent.

To create a new extent from a polyline, right-click on the model's **Boundary** object and select **New Lateral Extent > From Polyline** or **New Base > From Polyline**. In the window that appears, select whether you will create a new polyline or use an existing one:

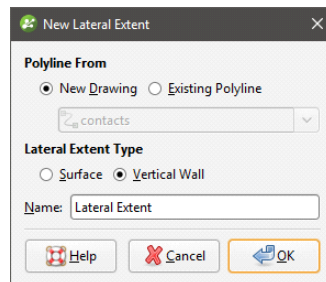

For lateral extents, you can create the extent as a **Vertical Wall** or **Surface**. If you create the lateral extent as a **Surface**, you will be able to modify it using additional data, as described below. A lateral extent created as a **Vertical Wall**, however, cannot be modified. A base is always created as a surface and so can be modified as described below.

Click **OK** to generate the new extent. If you have chosen to create a **New Drawing**, the drawing controls will appear in the scene and you can begin drawing, as described in [Drawing in the Scene](#).

The new extent will appear in the project tree as part of the **Boundary** object.

If the surface generated does not fit the polyline adequately, you can increase the quality of the fit by adding more points to the polyline. See [Drawing in the Scene](#) for information on adding points to polylines.

Extents created from polylines can be modified by adding points data, GIS vector data and structural data. You can also add polylines and structural data to the extent. See [Adding Data to an Extent](#), [Editing an Extent with a Polyline](#) and [Editing an Extent with Structural Data](#) for more information.

Extent From GIS Vector Data

GIS data in the project can be used to create a lateral extent or a base for a geological model. Once the data you wish to use has been imported into the project, right-click on the model's **Boundary** object and select **New Lateral Extent > From GIS Vector Data** or **New Base > From GIS Vector Data**.

In the window that appears, select the data object you wish to use:

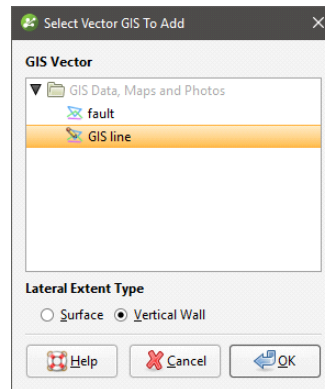

For lateral extents, you can create the extent as a **Vertical Wall** or **Surface**. If you create the lateral extent as a **Surface**, you will be able to modify it using additional data, as described below. A lateral extent created as a **Vertical Wall**, however, cannot be modified. A base is always created as a surface and so can be modified as described below.

If you select the **Surface** option, you can use the GIS data object with its own elevation data or projected onto the topography:

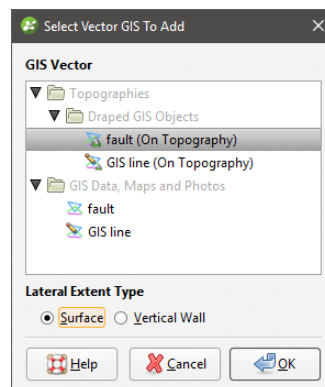

Using the **On Topography** option makes sense for GIS data as it is, by nature, on the topography. The **On Topography** option also mitigates any issues that may occur if elevation information in the GIS data object conflicts with that in the project.

Click **OK** to create the new extent. The new extent will appear in the project tree as part of the **Boundary** object.

Extents created from GIS data can be modified by adding points data, GIS vector data and structural data. You can also add polylines and structural data to the extent. See [Adding Data to an Extent](#), [Editing an Extent with a Polyline](#) and [Editing an Extent with Structural Data](#) for more information.

Extent From Points

To create a new extent from points data, right-click on the **Boundary** object for the model you are working on and select **New Lateral Extent > From Points** or **New Base > From Points**. The **Select Points To Add** window will be displayed, showing points data available in the project:

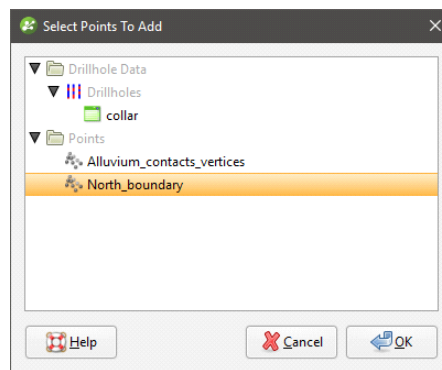

Select the information you wish to use and click **OK**.

The new extent will appear in the project tree as part of the **Boundary** object.

Extents created from points can be modified by adding points data, GIS vector data and structural data. You can also add polylines and structural data to the extent. See [Adding Data to an Extent](#), [Editing an Extent with a Polyline](#) and [Editing an Extent with Structural Data](#) for more information.

Extent From Structural Data

Planar structural data can be used to create a lateral extent or a base for a geological model. You can create a new structural data table or use a table that already exists in the project. If you want to use categories of structural data in creating the extent, use an existing table and create filters for those categories before creating the lateral extent.

To start, right-click on the **Boundary** object for the model you are working on and select **New Lateral Extent > From Structural Data** or **New Base > From Structural Data**. The **New Structural Data** window will be displayed, showing structural data available in the project:

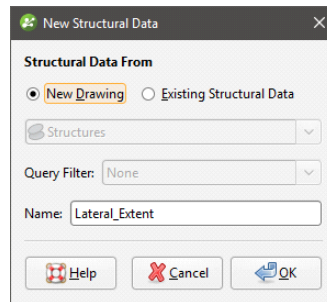

Select the **New Drawing** option to draw the structural data points directly in the scene.

Select the **Existing Structural Data** option to use a table in the **Structural Modelling** folder. With this option, you will be able to select from the categories available in the data table, if query filters have been created for those categories:

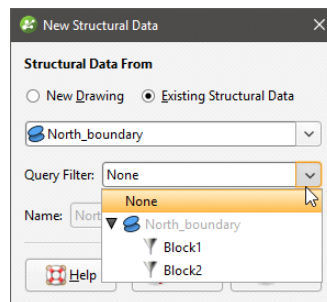

Click **OK** to generate the new extent. If you have chosen to create a **New Drawing**, the drawing controls will appear in the scene and you can begin drawing, as described in [Creating New Planar Structural Data Tables](#). To share the new structural data table, right-click on it and select **Share**. The table will be saved to the **Structural Modelling** folder.

The new extent will appear in the project tree as part of the **Boundary** object.

Extents created from structural data can be modified by adding points data, GIS vector data and structural data. You can also add polylines and structural data to the extent. See [Adding Data to an Extent](#), [Editing an Extent with a Polyline](#) and [Editing an Extent with Structural Data](#) for more information.

Extent From a Surface

To use a surface as an extent for a geological model, right-click on the model's **Boundary** object and select **New Lateral Extent > From Surface** or **New Base > From Surface**. The **Select Boundary** window will appear, showing all the meshes that can be used as an extent:

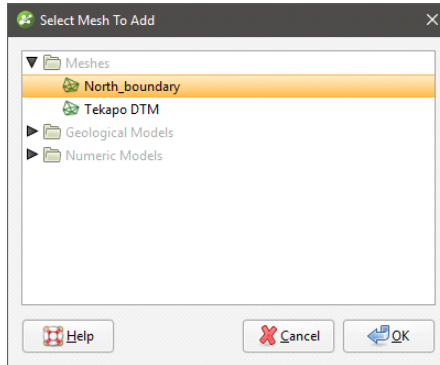

Select the required mesh and click **OK**. The extent will be added to the model's **Boundary** object.

You cannot modify an extent created from a mesh by adding data, editing with polylines or structural data or by applying a trend. However, the extent is linked to the mesh used to create it, and updating the mesh will update the extent.

Extent From Distance to Points

Leapfrog Geo can calculate the distance to set of points and use the resulting distance buffer as a lateral extent for a geological model. To create a new lateral extent from a distance buffer, right-click on the **Boundary** object for the model you are working on and select **New Lateral Extent > From Distance To Points**. The **Smoothed Distance Buffer** window will appear:

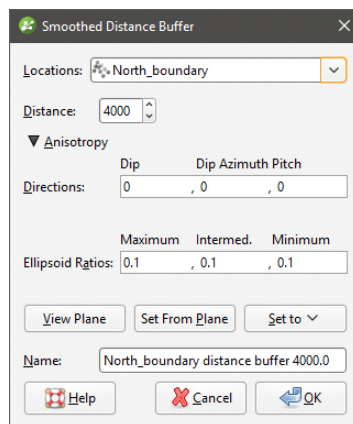

Select the **Distance** and set an **Anisotropy**, if required.

The **Ellipsoid Ratios** determine the relative shape and strength of the ellipsoids in the scene, where:

- The **Maximum** value is the relative strength in the direction of the green line on the moving plane.

- The **Intermed.** value is the relative strength in the direction perpendicular to the green line on the moving plane.
- The **Minimum** value is the relative strength in the direction orthogonal to the plane.

You can also use the **Set to** list to choose different options Leapfrog Geo has generated based on the data used to build the model. **Isotropic** is the default option used when the model is created.

Click **OK** to create the new extent, which will appear in the project tree as part of the **Boundary** object.

To change the extent's settings, expand the model's **Boundary** object in the project tree and double-click on the extent. Adjust the **Distance** and **Anisotropy**, if required.

The resolution of extents is automatically inherited from the geological model. You can change the resolution for an extent if you want more or less detail than for the geological model as a whole. To do so, untick the box for **Inherit resolution from GM** and change the setting.

Extents created from a distance to points function can be modified by adding points data and GIS vector data. See [Adding Data to an Extent](#).

Extent From a Distance Function

A distance function calculates the distance to a set of points and can be used to bound a geological model. You can use an existing distance function as a lateral extent or create a new one.

To use a distance function as a lateral extent, right-click on the **Boundary** object for the model you are working on and select **New Lateral Extent > From Distance Function**. If there are no distance functions in the project, you will be prompted to create a new one. See [Distance Functions](#) for information on defining and editing the distance function.

When there are already distance functions in the project, you will be prompted to choose between creating a new function or using an existing one:

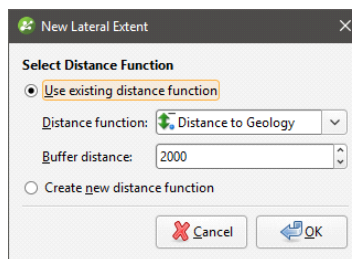

To use an existing function, select it from the list and set a **Buffer distance**. Click **OK** to create the lateral extent.

When you create a new distance function, it will be part of the model's **Boundary** object and will not be available elsewhere in the project. To share it within the project, expand the lateral extent in the project tree and right-click on the distance function. Select **Share**. The distance function will be saved to the **Numeric Models** folder.

To change the extent's settings, expand the model's **Boundary** object in the project tree and double-click on the extent. The **Edit Distance Buffer** window will appear.

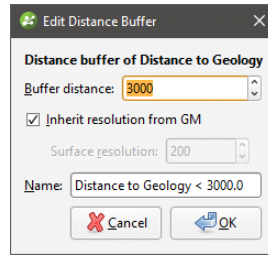

The resolution of extents is automatically inherited from the geological model. You can change the resolution for an extent if you want more or less detail than for the geological model as a whole. To do so, untick the box for **Inherit resolution from GM** and change the setting.

Base From Lithology Contacts

To create a base from lithology contacts, right-click on the **Boundary** object and select either **New Base > From Base Lithology** or **New Base > From Other Contacts**.

The only difference in the two methods is that when creating a base from other contacts, you must first select the lithology column from those available in the project.

When defining the base, select the primary lithology and the contacts to use:

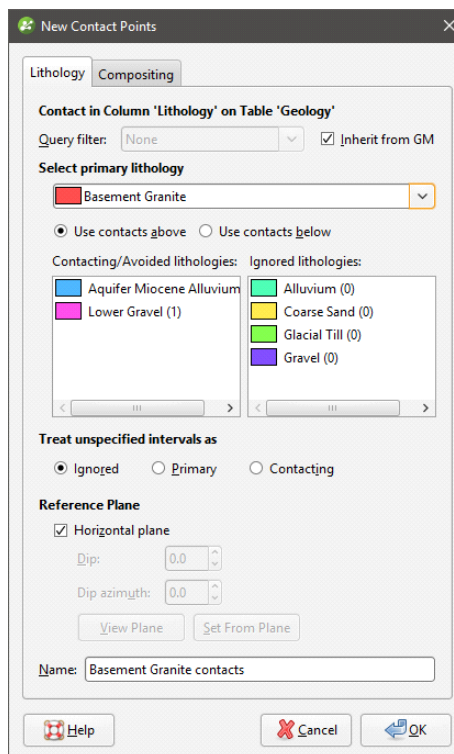

For complex geologies, the up and down directions for the base may not be clear. If this is the case, untick the **Horizontal Plane** box. A reference plane will appear in the scene, with the up-facing surface labelled A and the downward-facing surface labelled B. Controlling the position of the reference plane is similar to controlling the position of the moving plane:

- Use the handles in the scene window to move the plane.
- Set the **Dip** and **Dip Azimuth** values in the **New Contact Points** window. The reference plane will be updated in the scene.

Once the reference plane is correctly oriented, click the **Set From Plane** button.

Click **OK** to create the base, which will appear under the **Boundary** object. The new base will automatically be added to the model.

Each geological model can have only one base defined, so if you wish to define a new base, you must first delete the existing base from the model. Do this by right-clicking on the **Base** object and selecting **Delete**. You can also choose not to use the base you have defined. See [Removing an Extent from a Geological Model](#) for more information.

Changing an Extent's Settings

For geological model extents created from from polylines, GIS data, points and structural data, you can change the extent's settings by double-clicking on it in the project tree.

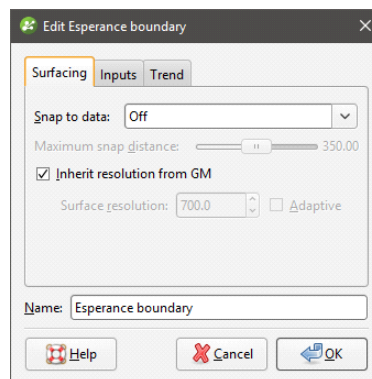

In the **Surfacing** tab, you can change surface resolution and contact honouring options, which are described below. In the **Trend** tab, you can apply a trend to the extent, which is described in [Applying a Trend](#).

Surface Resolution

For geological models, the resolution of extents and whether or not the adaptive isosurfer is used is automatically inherited from the geological model. You can change these settings for an extent if you want more or less detail than for the geological model as a whole. To do so, untick the box for **Inherit resolution from GM** and make the required changes.

Contact Honouring

Often, surfaces should honour drillhole data and treat data objects such as polylines and GIS data as interpretations. For extents, the **Snap to data** setting in the **Surfacing** tab determines whether or not the extent honours the data used to create it. Options are:

- **Off.** The extent does not snap to the data used to create it. This is the default setting.
- **All data.** The extent snaps to all data within the **Maximum snap distance**, which includes drillhole data and any data added to the extent.
- **Drilling only.** The extent snaps to drillhole data and data objects derived from drillhole data within the **Maximum snap distance**, but not to other data used to modify the extent. For example, the extent will honour points data derived from drillhole data, but not points data imported into the **Points** folder.
- **Custom.** The extent snaps to the data objects indicated in the **Inputs** tab that are within the **Maximum snap distance**.

Take care in enabling snapping and in selecting what data the surface will snap to, as the more data you include, e.g. by setting a large **Maximum snap distance** or selecting **All data** for **Snap to data**, the greater the possibility that errors in the data or assumptions inherent in interpretations (e.g. polylines) will cause distortions in the meshes. If you do enable snapping, it is best to snap only to drilling data. See [Honouring Surface Contacts](#) for more information on these settings.

The snap setting for the geological model will be used if **Snap to data** is set to **Inherit from GM**.

Whatever the setting, you can see what objects are snapped to by clicking on the **Inputs** tab.

If you need the extent to honour drillhole data but treat other data objects as interpretations, select **Drilling only**. To honour some data objects while treating others as interpretations, select **Custom**, then click on the **Inputs** tab to enable snapping for individual objects.

Applying a Trend

You can adjust an extent created from polylines, GIS data, points and structural data by applying a trend to it. To do this, add the extent to the scene. Next, double-click on the extent in the project tree and click the **Trend** tab.

Often the easiest way to apply a trend is to click on the **Draw plane line** button  and draw a plane line in the scene in the direction in which you wish to adjust the surface. You may need to rotate the scene to see the plane properly.

The **Ellipsoid Ratios** determine the relative shape and strength of the ellipsoids in the scene, where:

- The **Maximum** value is the relative strength in the direction of the green line on the moving plane.
- The **Intermed.** value is the relative strength in the direction perpendicular to the green line

on the moving plane.

- The **Minimum** value is the relative strength in the direction orthogonal to the plane.

Once you have adjusted the plane to represent the trend you wish to use, click the **Set From Plane** button to copy the moving plane settings.

The **Set to** list contains a number of different options Leapfrog Geo has generated based on the data used in the project. **Isotropic** is the default option used when the extent was created. Settings made to other surfaces in the project will also be listed, which makes it easy to apply the same settings to many surfaces.

Click **OK** to apply the changes.

See [Global Trends](#) for more information.

Adding Data to an Extent

Extents created from polylines, GIS data, points and structural data can be modified by adding points data objects, GIS vector data and structural data. Extents created from a distance to points function can be modified by adding points data and GIS vector data. To add data to an extent, right-click on the extent in the project tree and select the data type you wish to use from the **Add** menu.

- Points data. Select from the points data objects available in the project and click **OK**.
- GIS vector data. Select from the GIS vector data available in the project and click **OK**.
- Structural data. Select from the structural data tables available in the project. If the selected table has query filters defined, you can apply one of these filters by selecting the required query from the list. Click **OK** to add the selected data to the extent. An alternative to adding an existing structural data table to an extent is to edit the extent with structural data. This is described in [Editing an Extent with Structural Data](#) below.

You can also add a polyline that already exists in the project. To do this, right-click on the extent in the project tree and select **Add > Polyline**. You will be prompted to choose from the polylines in the **Polylines** folder.

Editing an Extent with a Polyline

You can edit an extent using a polyline, which is described in [Editing Surfaces with Polylines](#). A polyline used to edit an extent will be added to the project tree as part of the extent. To edit the polyline, right-click on it and select **Edit Polyline** or add it to the scene and click the **Edit** button () in the shape list. If you wish to remove the polyline from the extent, right-click on it in the project tree and select **Delete** or **Remove**.

To add an existing polyline to a geological model extent, use the **Add > Polyline** option.

Editing an Extent with Structural Data

You can edit an extent using structural data, which is described in [Editing Surfaces with Structural Data](#). A structural data table will be added to the project tree as part of the extent. To edit the table, right-click on it and select **Edit In Scene** or add it to the scene and click the

Edit button (✎) in the shape list. If you wish to remove the table from the extent, right-click on it in the project tree and select **Delete** or **Remove**.

Removing an Extent from a Geological Model

If you have defined an extent and want to remove it from the model, there are two options. The first is to right-click on the extent in the project tree and click **Delete**. This deletes the extent from the model, but does not delete parent objects from the project unless they were created as part of the model, e.g. a polyline used as a lateral extent but not shared within the project. Use this option only if you are sure you do not want to use the extent.

The second method is useful if you are making changes to the extent and do not want to recompute the model with each change. Double-click on the model's **Boundary** object or double-click on the model and click on the **Boundary** tab. The **Boundaries** part of the window lists all objects used as extents for a geological model:

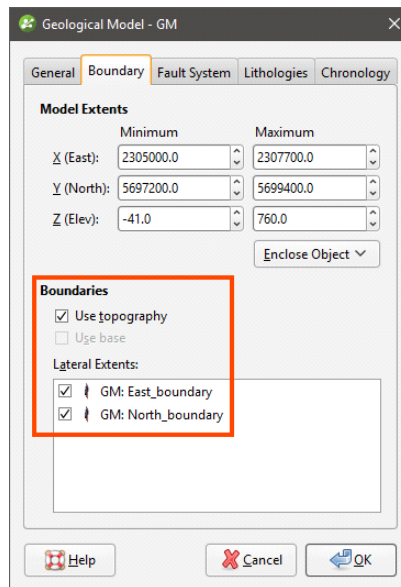

Untick the box for extents to temporarily disable them in the model. The model will be reprocessed, but you can then work on the extent without reprocessing the model. Disabled extents will be marked as inactive in the project tree:

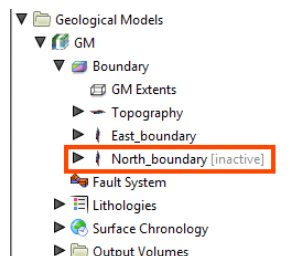

Model Lithologies

To view the lithologies used for a geological model, you can:

- Double-click on the geological model in the project tree and then click on the **Lithologies** tab.
- Double-click on the **Lithologies** object for the geological model in the project tree.

All the lithologies defined for the geological model are displayed, together with the colours used to display them:

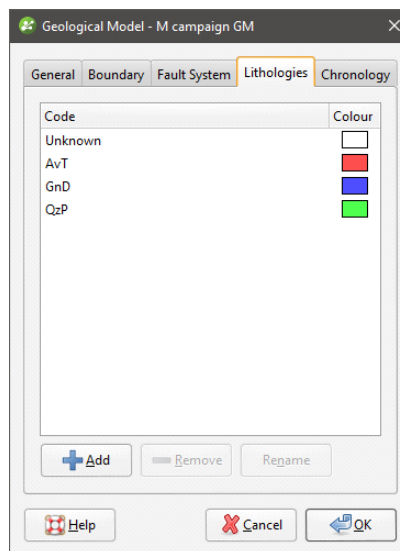

Click a colour chip to change the colours used to display the lithologies.

To set multiple lithologies to a single colour, use the Shift or Ctrl keys to select the colour chips you wish to change, then click on one of the colour chips. The colour changes you make will be made to all selected lithologies.

If the geological model was created from drillhole data, the lithologies are automatically generated from that data. There is also an additional lithology, "Unknown", which is used to label lithologies that cannot be labelled using known lithologies. This is the case when a geological model is first created and no contact surfaces have been defined. The entire model volume has no identified lithologies and so is assigned as "Unknown".

An alternative to setting unidentified lithologies to "Unknown" is to select one of the defined lithologies as the "background lithology". To do this, double-click on the model's **Surface Chronology** and set **Background lithology** to one of the available lithologies. When you set the background lithology for a geological model and then enable the fault system, the background lithology will be copied to each fault block.

If there is no drillhole data in the project or if the model is not based on drillhole data, you will need to define the lithologies one-by-one. To do this, click on the **Add** button, enter a name for the lithology and choose a colour.

Faulted Models

This topic describes how to use the fault system to create and organise faults:

- [The Fault System](#)
- [Fault Interactions](#)
- [Activating the Fault System](#)
- [Copying the Surface Chronology to an Empty Fault Block](#)
- [Faulted Model Display Options](#)

Each geological model is created with a **Fault System** object that is used to construct faults. Once the faults are active in the geological model, the geological model will be divided into separate fault blocks, which will appear in the project tree as part of the model:

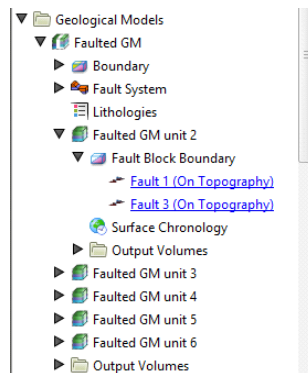

Each fault block has its own **Surface Chronology**, which can be modified without affecting other fault blocks in the geological model. There is no top-level **Surface Chronology** for the geological model once the **Fault System** has been activated. This means that lithology layers can be constructed for a faulted model in two ways:

- Define the **Surface Chronology** before enabling the **Fault System**. All surfaces defined for the unfaulted model will automatically be copied to each fault block. Some surfaces defined for the model as a whole will not occur in every fault block, which can be corrected by working with the surfaces in each fault block.
- Enable the **Fault System** before any surfaces are defined in the unfaulted model, then define the **Surface Chronology** for each fault block. An aid to working with a faulted model in this way is the ability to copy contact surfaces from one faulted block to another. See [Copying the Surface Chronology to an Empty Fault Block](#) below.

Which approach is best depends on the model being built. You may already know where the faults are and choose to define them and subdivide the geological model before defining any lithology layers. On the other hand, sometimes it is not apparent where the faults are until the layers have been built, in which case you can add the new fault, activate it in the model, then work with the surfaces in each fault block.

The Fault System

When a geological model is first created, the **Fault System** object is empty. To create faults, right-click on the **Fault System** object and select from the options available. Many of these options are similar to those for creating lateral extents. For more information, see:

- [Extent From a Polyline](#)
- [Extent From GIS Vector Data](#)
- [Extent From Points](#)
- [Extent From Structural Data](#)
- [Extent From a Surface](#)

Faults created from polylines and GIS vector data can be created as vertical walls or surfaces. Faults created as surfaces can be modified by adding further data, as described in [Editing Faults](#).

Creating a fault from the base lithology or other contacts is similar to creating contact surfaces. See [Deposits and Erosions From the Base Lithology](#) and [Deposits and Erosions From Other Lithology Contacts](#) for more information.

Faults will appear in the project tree as part of the **Fault System** object and can be expanded to show how they were created:

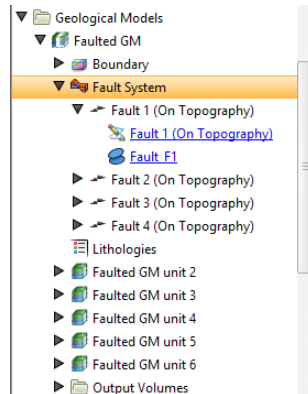

Once faults have been created, you can modify them as described in [Editing Faults](#).

Fault Interactions

Once all the faults required have been created, you can start defining the interactions between the faults by double-clicking on the **Fault System** object. The **Geological Model** will be opened with the **Fault System** tab displayed:

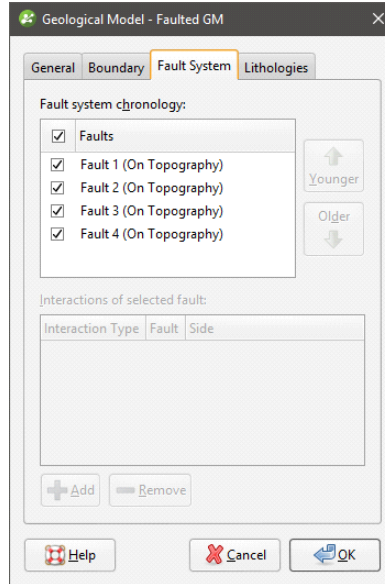

To add an interaction, click on a fault, then click the **Add** button. Select the **Interaction Type** and set how the faults interact:

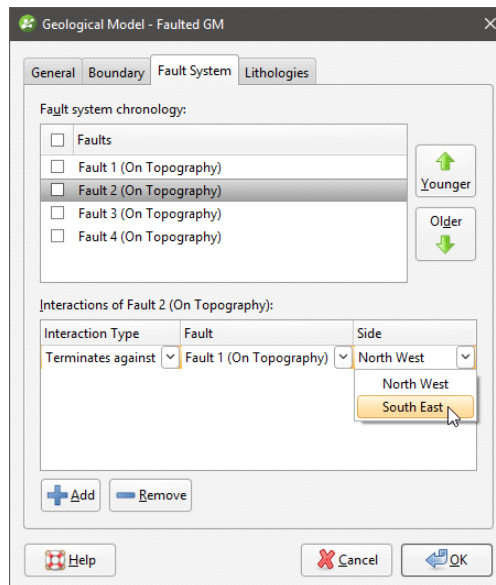

Once you have defined each fault interaction, click **OK** to generate the fault system. Add the **Fault System** object to the scene to check that the faults interact correctly.

You can also edit fault interactions by double-clicking on individual faults. The **Edit Fault** window will open, which shows only the interactions for the selected fault:

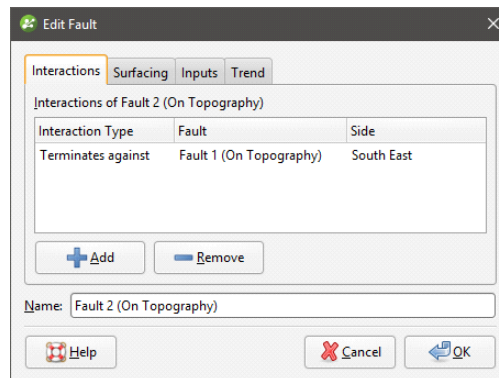

Faults are not active in the geological model until the box is ticked for each fault in the **Fault System** window, as described in [Editing Faults](#). This means you can check the fault system without regenerating the geological model.

Activating the Fault System

Activating the fault system divides the geological model into fault blocks, which can result in considerable processing time for complex models. It is important, therefore, to define fault interactions before enabling the fault system, otherwise a large number of fault blocks could be generated that significantly increase processing time. See [Fault Interactions](#) above.

To activate the fault system in the geological model, double-click on the **Fault System** object once again and tick the box for each fault. The model will be divided into separate fault blocks that can be worked with in a similar manner to the geological model as a whole.

Copying the Surface Chronology to an Empty Fault Block

If you are working with a faulted model and have defined the **Surface Chronology** for one fault block, you can copy the **Surface Chronology** to the empty fault blocks. To do this, right-click on the **Surface Chronology** for which you have defined surfaces and select **Copy Chronology To**. In the window that appears, select the fault blocks you want to copy contacts to and click **OK**. The surfaces will be copied and you can modify them without affecting the surfaces in the other fault blocks.

Faulted Model Display Options

Drag the model into the scene or right-click on it and select **View Object**; these options add the model to the shape list as a single object and you can change the visibility of each lithology by clicking the **Edit Colours** button. You can also add the model to the scene as a series of output volumes by right-clicking on the model and selecting **View Output Volumes**.

Another display option lets you view the individual fault blocks without displaying the lithology layers. Right-click on the model and select **View Fault Block Boundaries**.

To work with a specific fault block, click on it in the scene. The window that appears displays the name of the selected fault block:

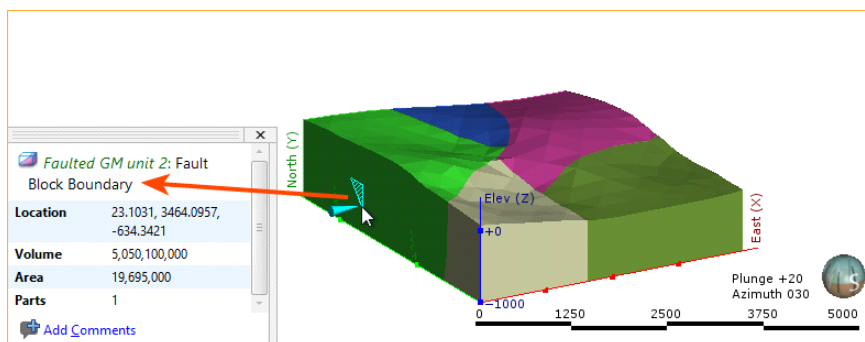

You can also view the output volumes for each individual fault block by right-clicking on the fault block in the project tree and selecting **View Output Volumes**.

Editing Faults

Once a fault has been defined, you can refine it in several ways:

- Add other data. This option is available for faults created as surfaces, but not for those created as vertical walls. Right-click on the surface to see the options available, which will depend on how the surface was created.
- Edit the surface with a polyline. Right-click on the surface in the project tree and select either **Edit > With Polyline**. See [Editing Surfaces with Polylines](#) for more information.
- Edit the surface using structural data. Right-click on the surface and select **Edit > With Structural Data**. See [Editing Surfaces with Structural Data](#) for more information.

The rest of this topic describes other options for editing faults. It is divided into:

- [Surfacing Options for Faults](#)
- [Changing Fault Inputs](#)
- [Applying a Trend to a Fault](#)

Surfacing Options for Faults

To change surfacing options for a fault, double-click on the fault in the project tree, then click on the **Surfacing** tab.

See [Surface Resolution for a Geological Model](#) and [Honouring Surface Contacts](#) for information about the settings in the **Surfacing** tab.

The settings in the **Surfacing** tab will be disabled if the fault inputs have been replaced with a mesh.

Boundary Filtering

When data objects are added to a fault, there are two ways to handle the data that lies outside the fault boundary:

- Filter the data. The fault is only influenced by the data that falls inside the fault boundary.
- Leave the data unfiltered. The fault is influenced by the data both inside and outside the fault boundary.

The **Boundary filter** setting determines how data used to define the fault is filtered:

- **Off**. Data is not filtered.
- **All data**. All data is filtered.
- **Drilling only**. Only drillhole data and data objects derived from drillhole data are filtered.
- **Custom**. Only the data objects specified in the **Inputs** tab are filtered.

Snapping to Data

There is a **Snap to data** setting for a geological model as a whole that is set in the **Geological Model > General** tab (see [Editing a Geological Model](#)). **Snap to data** can also be set on a surface-by-surface basis by double-clicking on the surface in the project tree and then clicking on the **Surfacing** tab.

For faults, the options are:

- **Inherit from GM**. The setting for the geological model as a whole is used. This is the default setting.
- **Off**. The fault surface does not snap to the data used to create it.
- **All data**. The fault surface snaps to all data within the **Maximum snap distance**, which includes drillhole data and any data added to the fault.
- **Drilling only**. The fault surface snaps to drillhole data and data objects derived from drillhole data within the **Maximum snap distance** but not to other data used to modify the fault. For example, the fault surface will honour points data derived from drillhole data, but not points data imported into the **Points** folder.
- **Custom**. The fault surface snaps to the data objects indicated in the **Inputs** tab.

Take care in enabling snapping and in selecting what data the surface will snap to, as the more data you include, e.g. by setting a large **Maximum snap distance** or selecting **All data** for **Snap to data**, the greater the possibility that errors in the data or assumptions inherent in interpretations (e.g. polylines) will cause distortions in the meshes. If you do enable snapping, it is best to snap only to drilling data. See [Honouring Surface Contacts](#) for more information

on these settings.

If you need the fault surface to honour drillhole data but treat other data objects as interpretations, select **Drilling only**. To honour some data objects while treating others as interpretations, select **Custom**, then click on the **Inputs** tab to enable snapping for individual objects.

Changing Fault Inputs

For faults, the **Inputs** tab shows all the data objects used to create the fault and whether the **Snap** and **Boundary filter** options are enabled for each object used to define the fault. If an input has any query filters defined, you can select one in this window.

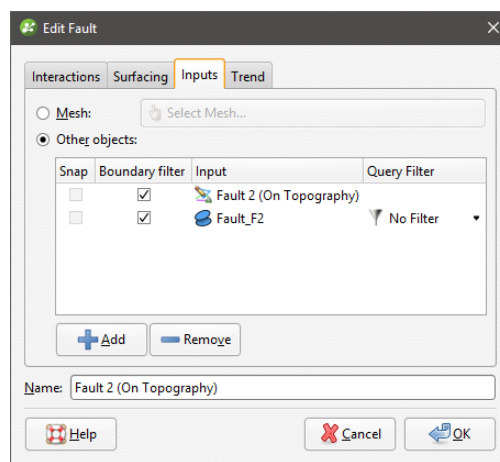

You can also replace the fault's inputs with a single mesh or add more data to the fault.

Replacing Fault Inputs with a Single Mesh

To replace the fault inputs with a single mesh, click on the **Mesh** option, then select from the meshes available in the project.

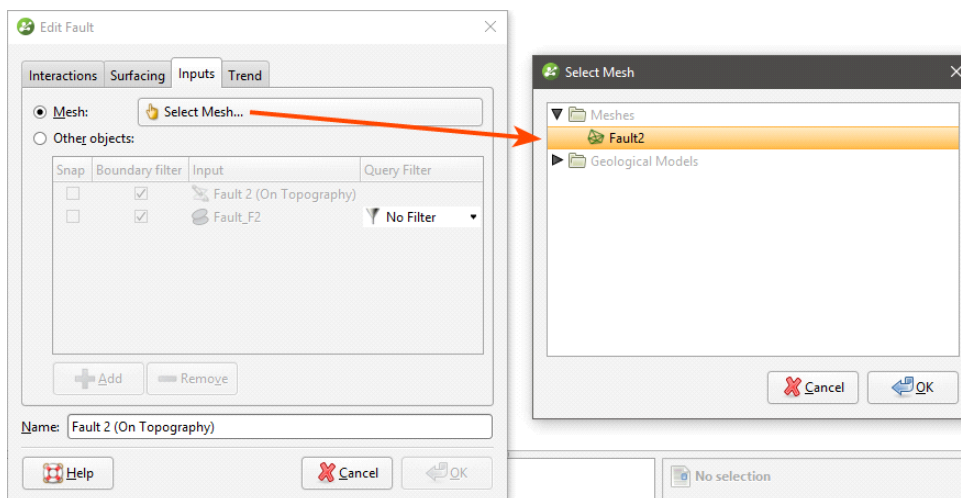

When you select a single mesh to define the fault, all other inputs listed in the **Inputs** tab will

be removed from the fault. This can result in objects being deleted from the project. For example, if the fault has been edited using a polyline, the polyline will be deleted when the inputs are replaced with the mesh. If you wish to retain such inputs, be sure to share the object before changing the inputs. See [Sharing Objects](#) for more information.

The snap and boundary filtering controls in the **Surfacing** tab will be disabled as the settings from the geological model will be used. The settings in the **Trend** tab will also be disabled as it is not possible to set a trend for a fault defined from a mesh.

Adding Data to the Fault

To add more data to the fault, click on the **Select Objects** button, then select from the suitable objects available in the project.

Snap Settings for Individual Inputs

The **Snap** setting determines whether or not the faults surface honours a particular data object. Often, surfaces should honour drillhole data and treat data objects such as polylines and GIS data as interpretations, as discussed in [Honouring Surface Contacts](#). To change snap settings for a fault, click on the **Surfacing** tab and set **Snap to data** to **Custom**. You will then be able to change **Snap** settings in the **Inputs** tab.

Boundary Filtering Settings for Individual Inputs

When data objects are added to a fault, there are two ways to handle the data that lies outside the fault boundary:

- Filter the data. The fault is only influenced by the data that falls inside the fault boundary.
- Leave the data unfiltered. The fault is influenced by the data both inside and outside the fault boundary.

To change the **Boundary filter** settings for each object used to define a fault, click on the **Surfacing** tab and set **Boundary filter** to **Custom**. You will then be able to change **Boundary filter** settings in the **Inputs** tab.

Applying a Trend to a Fault

To apply a trend to a fault, either:

- Double-click on the fault in the project tree, then click on the **Trend** tab.
- Right-click on the fault in the project tree and select **Adjust Surface**. This opens the **Edit Fault** window with the **Trend** tab displayed.

See [Global Trends](#) for information on using the controls in this tab.

The settings in the **Trend** tab will be disabled if the fault inputs have been replaced with a mesh.

Contact Surfaces

Defining the internal structure of a geological model involves generating contact surfaces that correspond to the boundaries between lithological units, refining the contact surfaces, arranging them in chronological order and then using the surfaces and the chronological order to divide the geological model into units. The **Surface Chronology** object represents the collection of contact surfaces and defines how they interact to produce the volumes of the geological model. Factors that influence the interaction of contact surfaces with the volumes of the geological model are:

- The order of the contact surfaces in the **Surface Chronology**. See [Contact Surfaces in the Surface Chronology](#).
- The type of contact surface. See [Contact Surfaces Types](#) for more information.
- The orientation of the older and younger sides of the surface. See [Younging Direction](#).

The remainder of this topic describes how the different types of contact surface interact and will help you in deciding how to model different units. For specific information on creating the different types of contact surfaces, see:

- [Deposits and Erosions](#)
- [Intrusions](#)
- [Veins](#)
- [Vein Systems](#)
- [Stratigraphic Sequences](#)

Contact Surfaces in the Surface Chronology

When a geological model is first created, it is simply a volume that is assigned the background lithology. This background lithology is initially "Unknown", as although the model has lithologies defined, Leapfrog Geo cannot determine what lithology to use for the background lithology.

The contact surfaces and their order in the **Surface Chronology** determine how they divide this larger “Unknown” volume into known lithological units. The scene below shows the **Surface Chronology** for four deposit contact surfaces and two intrusion contact surfaces, bounded by the geological model extents (pink). The two intrusion contacts are labelled as Unknown on the outside and the intrusion lithology on the inside:

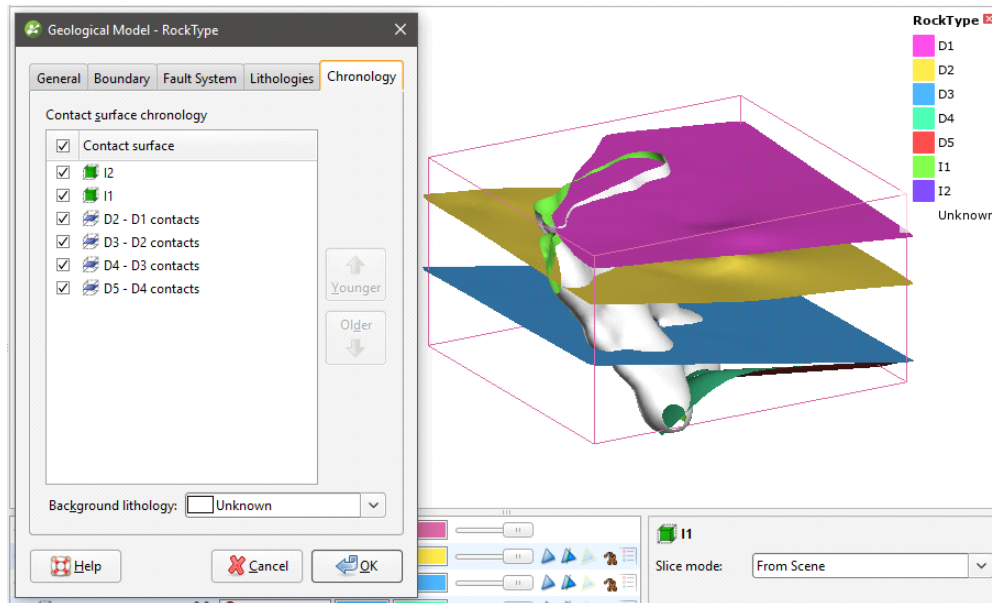

The **Surface Chronology** is open, showing the contact surfaces in chronological order, with the youngest at the top of the list. This is the order in which contact surfaces will be used to cut the “Unknown” volume of a newly created model. The different types of contact surfaces cut older volumes in different ways, which are described below in [Contact Surface Types](#).

For the model shown above, the first contact surface to cut the geological model volume is the oldest surface, D5 - D4 contacts. The volume is divided into D5 (red) below and D4 (green) above:

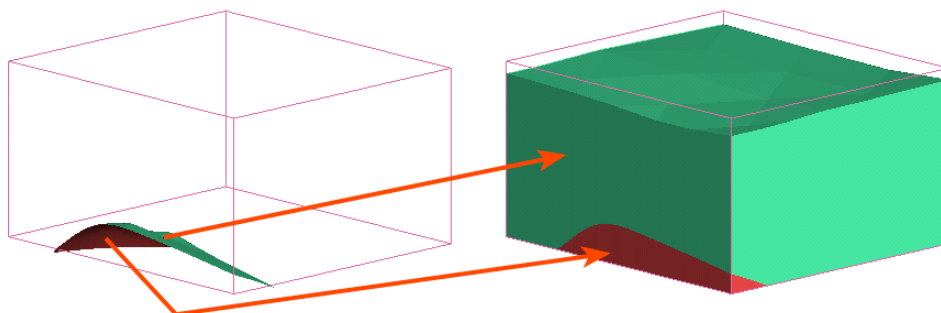

When the next contact surface (D4 - D3 contacts) is enabled in the model, the volume above the contact surface is labelled with the lithology assigned to the surface's younger side (blue):

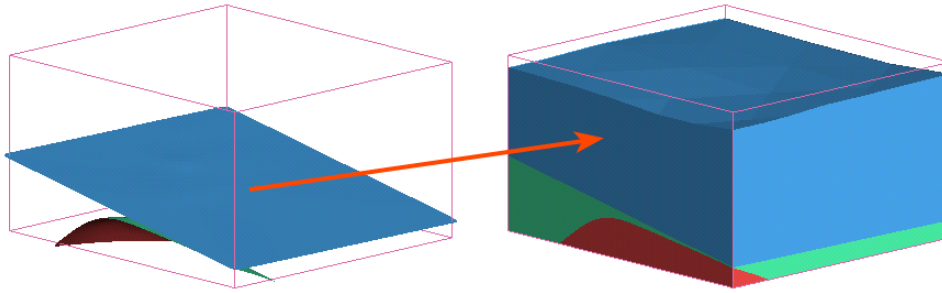

Therefore, any volume in a geological model is labelled with the lithology assigned to the youngest side of the surface that last cut the volume.

With a simple deposit geological model, as long as each side of each contact surface is assigned a lithology, all volumes will be labelled with known lithologies. Intrusive contact surfaces, however, are often of unknown lithology on the outside, as they contact multiple lithologies. When the two intrusive surfaces in the model above are enabled but all deposit surfaces are disabled, the unknown lithology is replaced with each intrusive lithology on the inner sides of each contact surface, but outside each intrusive contact surface the lithology is not known:

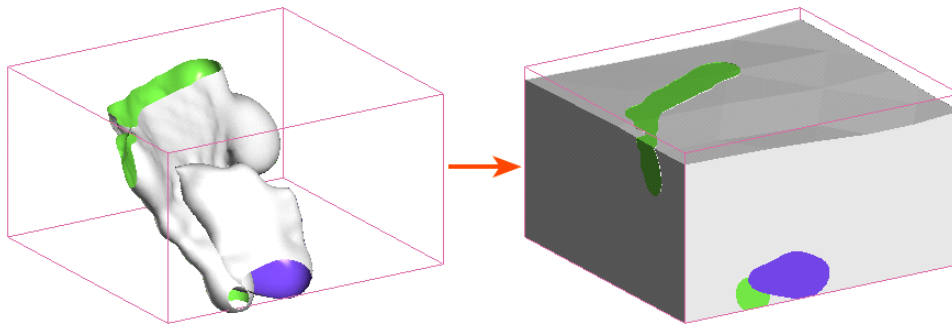

If the outside of the older contact surface (green) is assigned a lithology (red), the volume outside each intrusion is known and, therefore, the surrounding volume can be labelled:

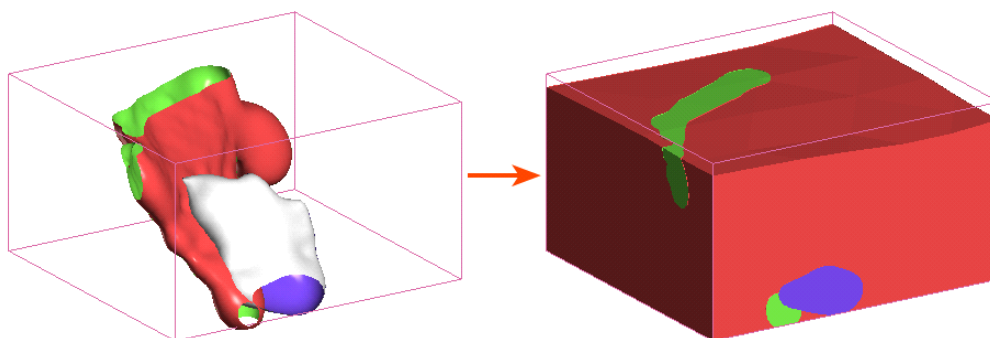

If, however, the outside of the younger intrusion is known but the outside of the older intrusion is unknown, it is not possible to determine the lithology of the surrounding volume as the lithology on the outer side of the surface making the first cut is not known:

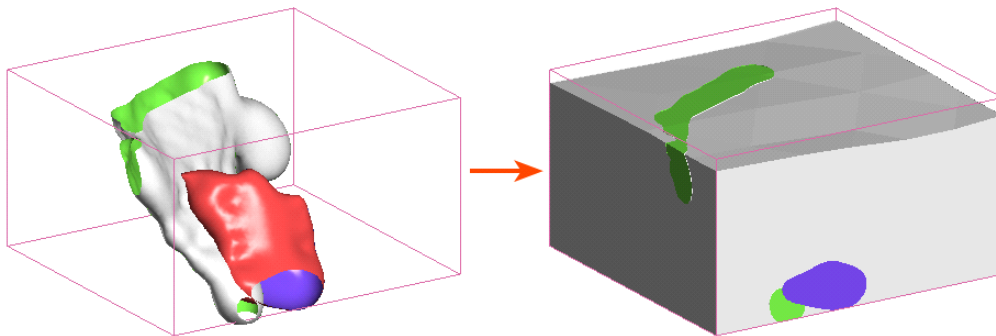

Contact Surfaces Types

The different types of contact surfaces result in different shapes and cut older volumes in different ways. The contact surface types are:

- **Deposit.** Deposit contact surfaces tend to be sheet-like, with the primary lithology on the young side and the contacting/avoided lithologies on the older side. Deposits do not cut older volumes. A volume defined by a deposit contact surface will, therefore, appear conformably on top of older volumes.
- **Erosion.** Erosion contact surfaces are similar to deposits, but cut away other contact surfaces on the older side of the erosion contact surface.
- **Intrusion.** Intrusion contact surfaces are rounder in shape, with an interior lithology that represents the intrusion lithology. The intrusion removes existing lithologies and replaces them with the intrusive lithology on the younger side of the contact surface. Often, the older side of an intrusion contact surface is labelled "Unknown" as typically intrusions displace multiple older lithologies.
- **Vein.** Vein contact surfaces remove existing lithologies and replace them with the vein lithology within the boundaries defined by hangingwall and footwall surfaces and points and a reference surface.

These terms are indicative of the resulting shape and cutting behaviour of a surface rather than of the geological formations that can be modelled. In fact, it might make sense to model something like basement granite as a deposit rather than as an intrusion when it forms the lowest layer in the geological model. If there are no older layers for an intrusion-type contact surface to remove and it is apparent from the drillhole data that the lithology simply fills the lowermost parts of the model, then it makes sense to model it as a deposit.

An important consideration in building contact surfaces is that they have an older side and a younger side. This is described in more detail in [Younging Direction](#) below, but it is sufficient to understand, at this point, that younging direction is one factor in determining how the different types of contact surfaces cut older surfaces.

Deposit and Erosion Contact Surfaces

Deposits and **erosions** are both roughly flat surfaces. The difference between the two is that deposits appear conformably on top of underlying older volumes and do not occur in regions defined by older deposits, while erosions remove existing lithologies on the older side of the erosion. This difference is illustrated here, using a model made up of three deposits, A, B and C:

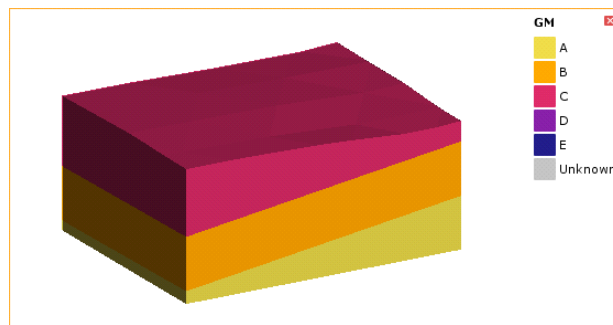

The contact surfaces that define the three output volumes are the B-C contacts surface (pink) toward the top of the model extents and the A-B contacts surface (gold) lower down:

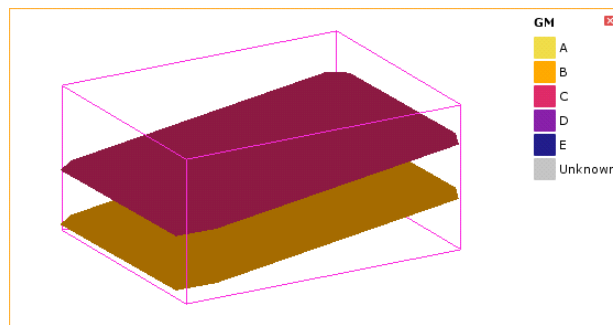

An erosion contact surface (C-D contacts) added to the model cuts across the A-B and B-C contacts. The younger (purple) side of the C-D contact surface faces up:

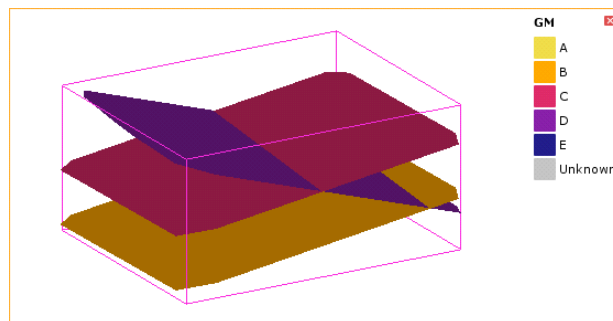

Once the model is recalculated, the erosion (D) has cut away the deposits on the older side of the erosion:

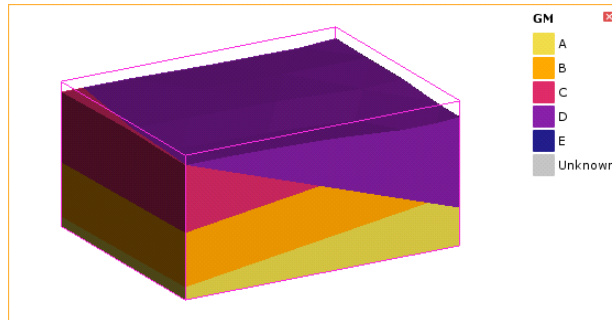

However, if the C-D contact surface is changed to be a deposit surface, D only occurs on the younger side of the C-D contact surface and does not cut away the A, B and C volumes:

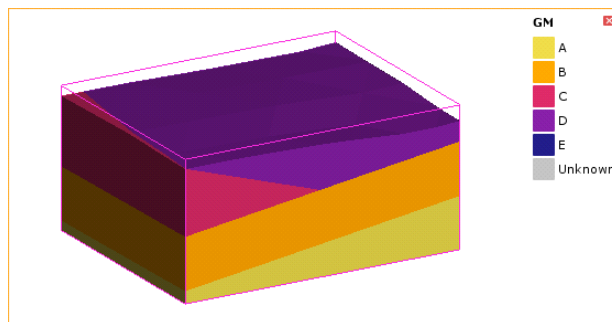

See [Deposits and Erosions](#) for information on techniques for creating deposits and erosions.

Intrusion Contact Surfaces

An **intrusion** is a type of contact surface that removes existing lithologies and replaces them with the intrusive lithology. Intrusions are rounder in shape than deposits and erosions, with an interior lithology that represents the intrusion lithology on the inside of the shape.

Adding an intrusion (E) surface added to the example model above as the youngest surface cuts away the other lithologies on the inside of the surface:

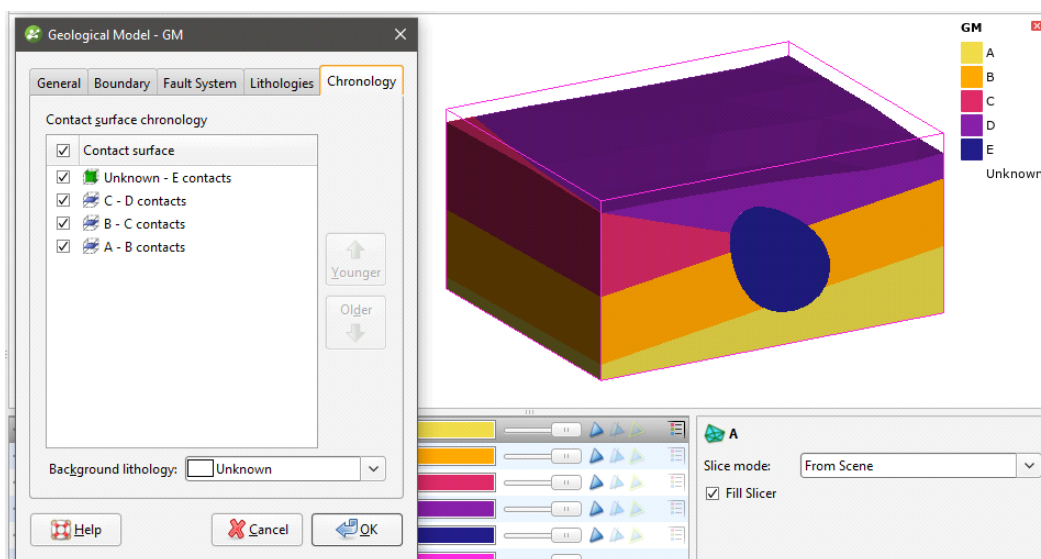

Note that the intrusion contacts multiple units. This is typical of intrusion contact surfaces as an intrusion will usually displace multiple older lithologies. Although the outside of the intrusion is not labelled with a lithology, the lithology of each volume the intrusion comes into contact with can be known from the lithologies assigned to the deposit contact surfaces.

However, when all contact surfaces are intrusions, the lithology of the surrounding volume cannot be known, which results in intrusion volumes surrounded by an Unknown volume:

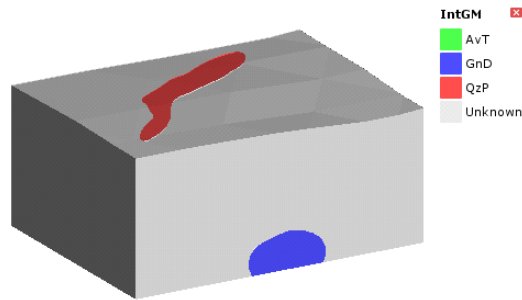

In this instance, the contact surfaces each have a known side and an unknown side:

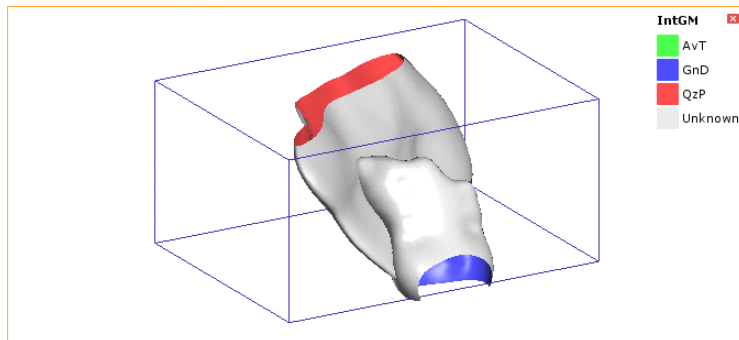

Adding the drillholes to the scene helps in understanding what lithology the outside of each intrusion should be:

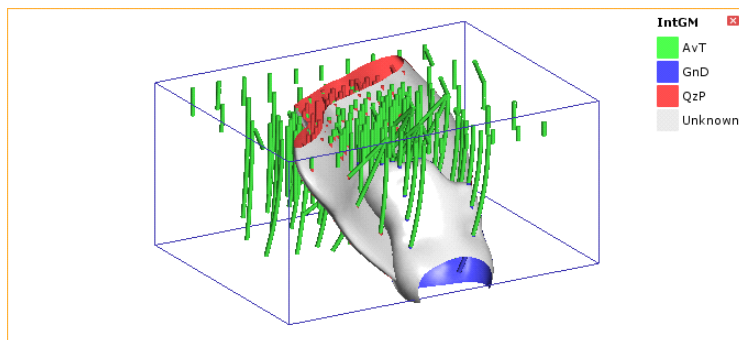

In this case, opening the **Surface Chronology** and assigning AvT as the background lithology results in a model for which all volumes are labelled with a known lithology:

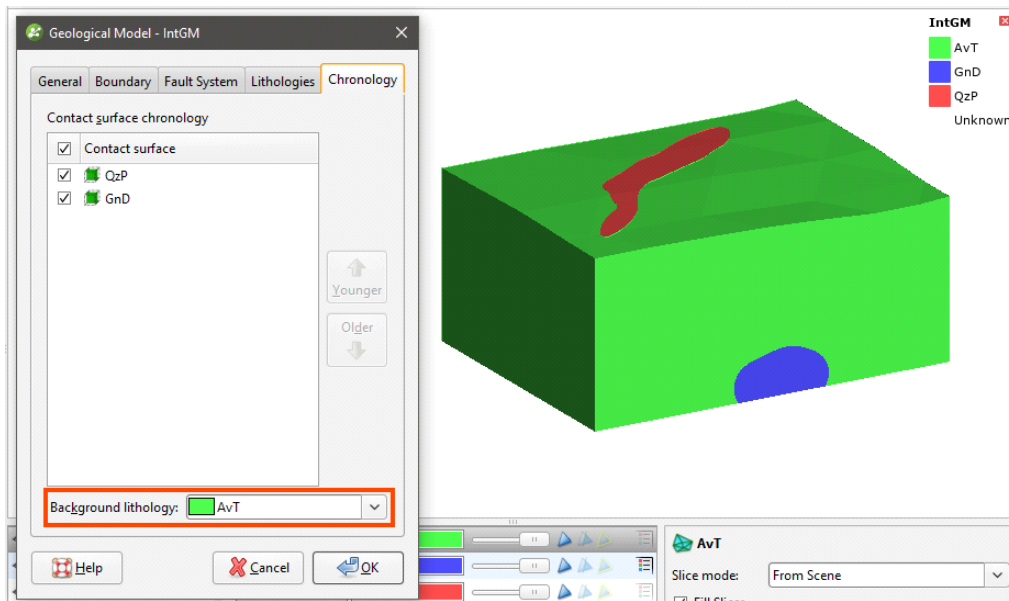

See [Intrusions](#) for information on techniques for creating intrusions.

Vein Contact Surfaces

Veins remove existing lithologies and replace them with the vein lithology within the boundaries defined by hangingwall and footwall surfaces and points and a reference surface. Here, a slice has been made horizontally through a model made up of three deposits:

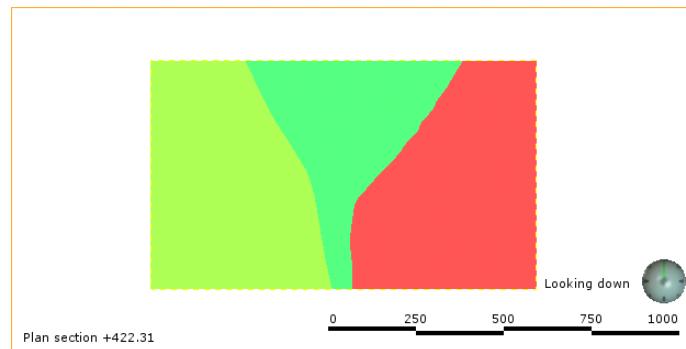

Adding five dykes modelled as veins and enabling them in the model results in the veins cutting away each deposit at the point of contact:

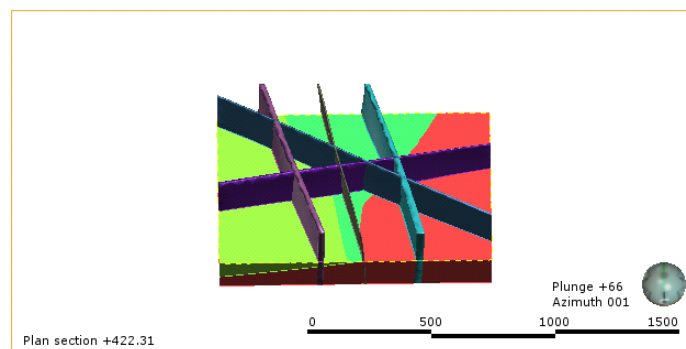

Here the sliced deposits are displayed but the veins are hidden in order to show how they cut away the deposits:

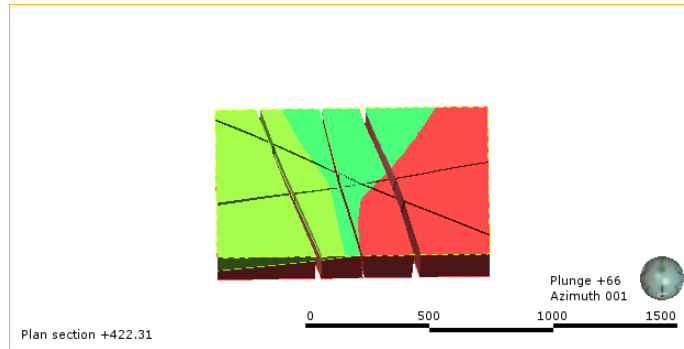

See [Veins](#) for information on techniques for creating veins.

Younging Direction

An important factor in determining how surfaces interact is the younging direction of each surface. Each contact surface has a younger side and an older side. For deposit and erosion contact surfaces, Leapfrog Geo will, by default, put the younger side up, since this is geologically reasonable in most situations. If, for example, you know that the geology is overturned, you can change the younging direction once the surface has been created.

For intrusion contact surfaces, the younger side of the surface is the inside, although this can be swapped if Leapfrog Geo has assigned it incorrectly, as may be the case with flatter intrusion surfaces.

When contact surfaces are displayed in the scene, you can choose whether to display the surfaces using the lithology or the younging direction. When the younging direction is displayed, the younger side is typically green and the older side is brown:

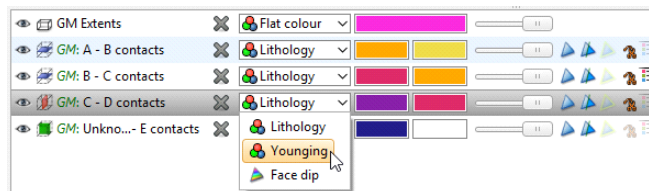

When a contact surface is displayed using the younging direction, Leapfrog Geo by default colours the younger side green and the older side brown.

Deposits and Erosions

This topic describes creating and editing deposits and erosions. The topic is divided into:

- [Creating Deposits and Erosions](#)
- [Deposits/Erosions in the Project Tree](#)
- [Refining Deposits and Erosions](#)
- [Surfacing Options for Deposits and Erosions](#)

For a general introduction to how deposits and erosions interact with other contact surfaces, see [Deposit and Erosion Contact Surfaces](#) in [Contact Surfaces](#).

Creating Deposits and Erosions

Lithology data is often the most reliable data source to use when building geological surfaces, and it is best to derive contact surfaces from lithology data when it is available. If no lithology data is available, you can create deposits and erosions from other data in the project. You can also create offset surfaces from other surfaces in the project, which is useful for creating a series of surfaces. See [Offset Surfaces](#) for more information.

Deposits and Erosions From the Base Lithology

It is best to derive contact surfaces from lithology data, when it is available. There are two ways to create contact surfaces from lithology data:

- Using the base lithology column assigned when the model was created. This is the process described below.
- Using other lithology information available in the project. This is useful when you have created an additional lithology column as part of correcting and working with the drillhole data. For example, if when building a geological model it becomes apparent that changes need to be made to the drillhole data, you can import additional data or create a new column using the split lithology, group lithology or interval selection tools. See [Deposits and Erosions From Other Lithology Contacts](#) for more information.

Selecting the **From Base Lithology** option opens the **New Contact Points** window:

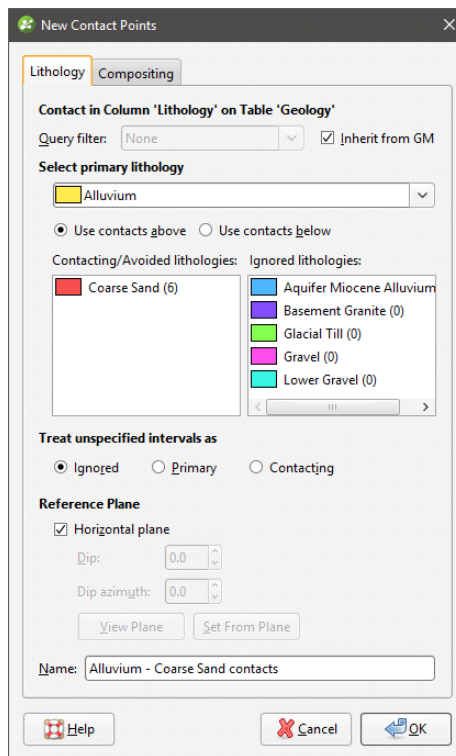

Select the lithology you wish to use to create the surface from the **Select primary lithology** list; this will be the older lithology (lower down) in the geological model. The **Contacting/Avoided**

lithologies list shows the lithologies that contact the primary lithology and the number of contacts. This helps in selecting which contacts to use to create the contact surface.

The options in the **Lithology** tab are useful for creating a surface when one lithology is interbedded with another. For example, here we can see that the coarse sand is interbedded with alluvium:

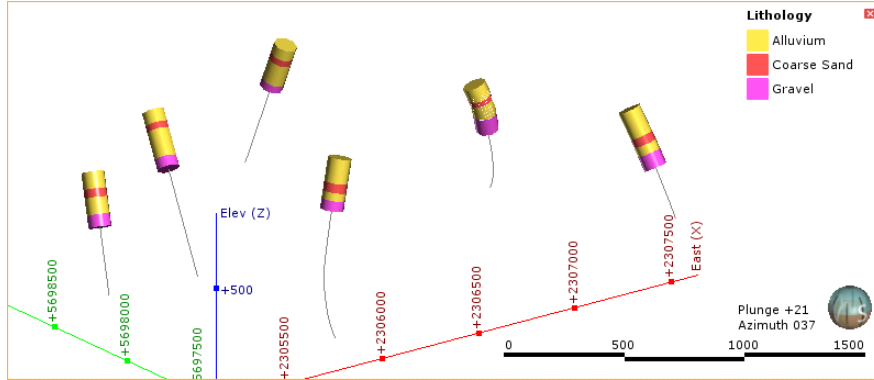

The solution to this is to create two surfaces from the Alluvium contacts, one using the contacts above (younger contacts) and the other using the contacts below (older contacts):

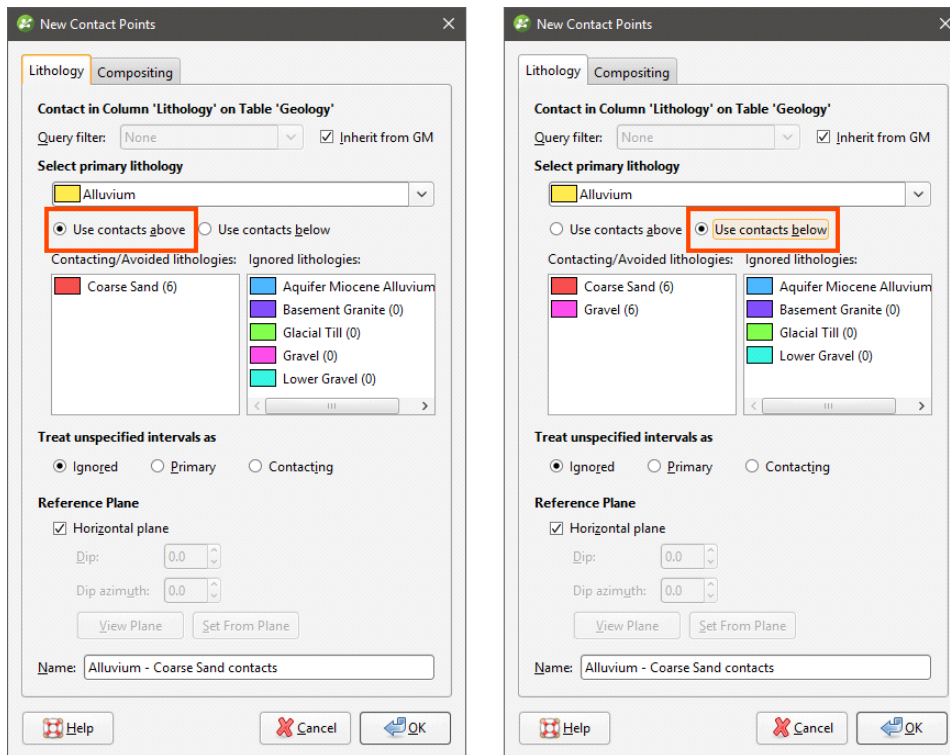

Note that the gravel contacts should be excluded for the surface created from the **Use contacts below** option, as we can see from the drillhole data that gravel appears lower down in the model than the surface we are creating. Do this by dragging the contacts that should be excluded to the **Ignored lithologies** list:

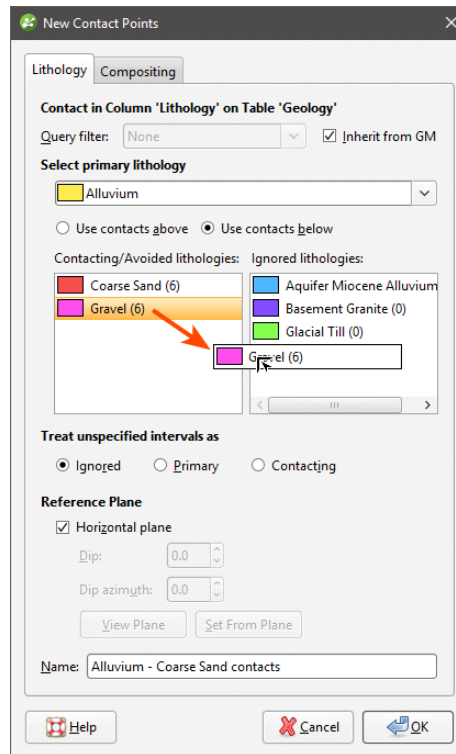

Unspecified intervals are intervals that have no data. By default, unspecified intervals are ignored when creating a contact surface, but you can also treat them as the primary lithology or as avoided lithologies.

For complex geologies, the up and down directions for the surface may not be clear. If this is the case, untick the **Horizontal Plane** box. A reference plane will appear in the scene, with the up-facing surface labelled A and the downward-facing surface labelled B:

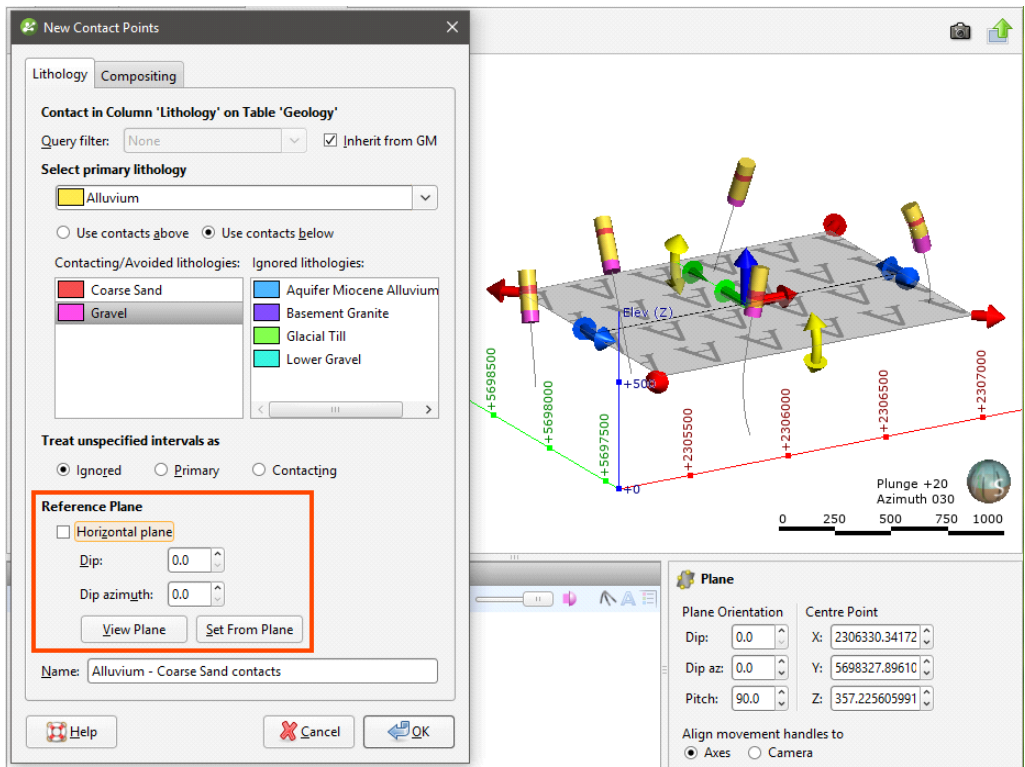

Controlling the position of the reference plane is similar to controlling the position of the moving plane:

- Use the handles in the scene window to move the plane.
- Set the **Dip** and **Dip Azimuth** values in the **New Contact Points** window. The reference plane will be updated in the scene.

Once the reference plane is correctly oriented, click the **Set From Plane** button.

Setting a reference plane for contact points is different from applying a global trend to a surface. To apply a global trend to a surface, double-click on the surface in the project tree and click on the **Trend** tab. See [Global Trends](#).

Data can be composited at the drillhole level or on a surface-by-surface basis. To composite the data used to generate the contact surface, click on the **Compositing** tab. See [Category Composites](#) for more information.

Click **OK** to create the contact surface, which will appear in the project tree under the **Surface Chronology**. See [Refining Deposits and Erosions](#) below for more information on refining the contact surface.

Deposits and Erosions From Other Lithology Contacts

Creating deposit and erosion contact surfaces using the **From Other Contacts** option is useful when you have created an additional lithology column as part of correcting and working with the drillhole data. For example, if when building a geological model it becomes apparent that

changes need to be made to the drillhole data, you can import additional data or create a new column using the split lithology, group lithology or interval selection tools. See [Splitting Lithologies](#), [Grouping Lithologies](#) and [Interval Selection](#) for more information.

The process is similar to creating a surface from the base lithology column, but you must first select the lithology column you will use:

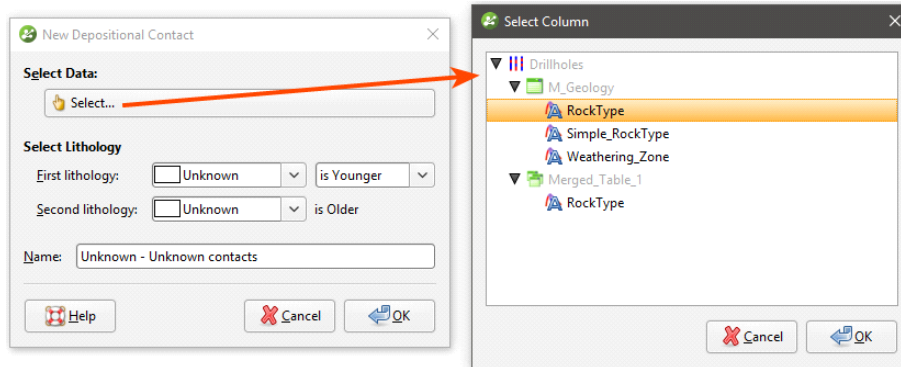

Select the **First Lithology** and **Second Lithology**, if known. Click **OK**. The **New Contact Points** window will appear. Assign the **Primary lithology**, **Contacting/Avoided lithologies** and the **Ignored lithologies**. These can only be selected from the model's base lithology.

The rest of the process is similar to defining a contact surface from the base lithology. See [Deposits and Erosions From the Base Lithology](#) above for more information.

Be sure to add the contact surface to the scene to view it and check that it is oriented correctly.

See [Refining Deposits and Erosions](#) below for more information on the different techniques that can be used for adjusting a contact surface.

Deposits and Erosions From Other Data

If suitable lithology data is not available, deposits and erosions can be created from other data in the project, such as GIS data, structural data, points, polylines and surfaces. The steps for creating deposits and erosions from other data are similar, regardless of the data used to create the surface:

- Right-click on the **Surface Chronology** and select one of the data types from the **New Deposit/Erosion** menu.
- Select the data object that will be used to define the surface. This must already be in the project, unless you are using a polyline, in which case you are given the option to create a new polyline.
- Select the **First lithology** and **Second lithology**. These are the lithologies that will be assigned to each side of the contact surface. The lithologies you can choose from are those defined for the geological model in the **Lithologies** object (see [Model Lithologies](#)).
- Set whether the **First lithology** is older or younger than the **Second lithology**. Leapfrog Geo will, by default, put the younger side of a contact surface up, but this can be changed later.

Here, a points data object is being used to create a deposit:

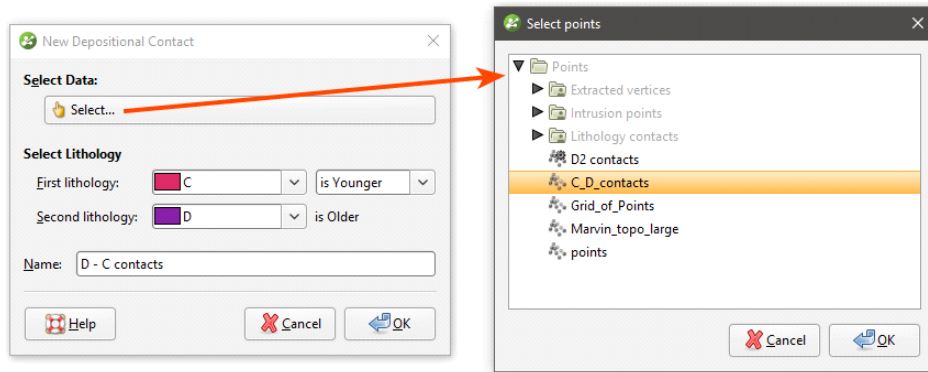

For polylines, you first set the lithologies and the younging order:

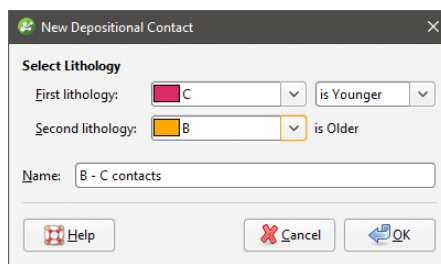

Click **OK** to move on to the next step:

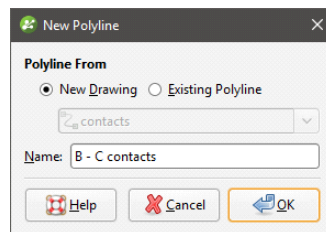

You can draw the polyline in the scene directly by selecting the **New Drawing** option. You can also use any polyline in the project by selecting the **Existing Polyline** option. You can then select the required polyline from the list.

The new contact surface will appear in the project tree under the **Surface Chronology**. Add the contact surface to the scene to view it and check that it is oriented correctly.

Expand the surface in the project tree to see how it was made. Here, a number of surfaces have been created using different types of data:

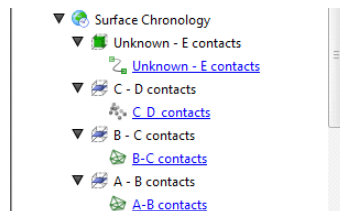

If creating a surface from a new polyline, the polyline will not be able to be used elsewhere in the project unless it has been shared. To share the polyline, expand the contact surface in the project tree, right-click on the polyline and select **Share**. The polyline will then be available elsewhere in the project.

As further refinements are made to the surface, that information will also be added to the contact surface in the project tree.

Deposits/Erosions in the Project Tree

The name Leapfrog Geo automatically assigns to a deposit or an erosion is the lithologies assigned to each side of the surface. In the project tree, expand the surface to see how it was made:

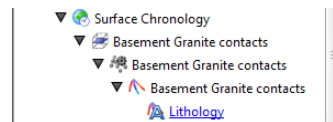

Double-click on the surface to edit it. Double-click on the contact points object (🌿) to edit the lithology and change compositing parameters.

As further refinements are made to the surface, that information will also be added to the project tree. See [Refining Deposits and Erosions](#) below for more information.

Refining Deposits and Erosions

You can refine deposits and erosions in several ways:

- Add other data. Right-click on the surface to see the options available, which will depend on how the surface was created. See [Adding Data to Surfaces](#) for more information.
- Edit the surface with a polyline. Right-click on the surface in the project tree and select either **Edit > With Polyline**. See [Editing Surfaces with Polylines](#) for more information.
- Edit the surface using structural data. Right-click on the surface and select **Edit > With Structural Data**. This option is available for deposits and erosions created from lithology data and other data in the project, but not for offset surfaces. See [Editing Surfaces with Structural Data](#) for more information.

To edit the surface's settings, double-click on it in the project tree. In the **Lithologies** tab, change the lithologies assigned to each side of the surface, if required.

You can swap the younging direction if the direction was assigned incorrectly when the surface was created. The change will be reflected in the scene. Note that changing the younging direction does not change which lithology is older or younger.

The difference between deposit and erosion contact surfaces is how they cut older lithologies, as described in [Contact Surfaces](#). For this reason, it is possible to change between the two types using the **Contact Type** setting.

For information on other techniques for refining deposits and erosions, see:

- [Surfacing Options for Deposits and Erosions](#)
- [Offset Surfaces](#)

Surfacing Options for Deposits and Erosions

Surfacing options for deposits and erosions can be changed by double-clicking on the surface in the project tree and then clicking on the **Surfacing** tab. There are additional settings related to boundary filtering and snapping to data in the **Inputs** tab.

Boundary Filtering

When data objects are added to a surface, there are two ways to handle the data that lies outside the surface's boundary:

- **Filter the data.** The surface is only influenced by the data that falls inside the surface's boundary.
- **Leave the data unfiltered.** The surface is influenced by the data both inside and outside the surface's boundary.

The **Boundary filter** setting determines how data used to define the surface is filtered:

- **Off.** Data is not filtered.
- **All data.** All data is filtered.
- **Drilling only.** Only drillhole data and data objects derived from drillhole data are filtered.
- **Custom.** Only the data objects specified in the **Inputs** tab are filtered.

Snapping to Data

Often, surfaces should honour drillhole data and treat data objects such as polylines and GIS data as interpretations. See [Honouring Surface Contacts](#).

There is a **Snap to data** setting for a geological model as a whole that is set in the **Geological Model > General** tab (see [Editing a Geological Model](#)). **Snap to data** can also be set on a surface-by-surface basis by double-clicking on the surface in the project tree and then clicking on the **Surfacing** tab.

For individual contact surfaces, the options are:

- **Inherit from GM.** The setting for the geological model as a whole is used. This is the default setting.
- **Off.** Surfaces do not snap to the data used to create them.
- **All data.** Surfaces snap to all data within the **Maximum snap distance**, which includes drillhole data and any data added to the surfaces.
- **Drilling only.** Surfaces snap to drillhole data and data objects derived from drillhole data within the **Maximum snap distance** but not to other data used to modify the surfaces.
- **Custom.** Surfaces snap to the data objects indicated in the **Inputs** tab for each surface.

Take care in enabling snapping and in selecting what data the surface will snap to, as the more data you include, e.g. by setting a large **Maximum snap distance** or selecting **All data** for **Snap to data**, the greater the possibility that errors in the data or assumptions inherent in

interpretations (e.g. polylines) will cause distortions in the meshes. If you do enable snapping, it is best to snap only to drilling data. See [Honouring Surface Contacts](#) for more information on these settings.

If you need a surface to honour drillhole data but treat other data objects as interpretations, select **Drilling only**. To honour some data objects while treating others as interpretations, select **Custom**, then click on the **Inputs** tab to enable snapping for individual objects.

Setting the Surface Resolution

See [Surface Resolution for a Geological Model](#) for information about the surface resolution settings in the **Surfacing** tab.

Applying a Trend to a Deposit/Erosion

There are two ways to change the trend for a deposit or an erosion:

- Right-click on the surface in the project tree and select **Adjust Surface**.
- Double-click on the surface in the project tree and then click on the **Trend** tab.

See [Global Trends](#) for more information.

Intrusions

This topic describes creating and editing intrusions. The topic is divided into:

- [Creating Intrusions](#)
- [Intrusions in the Project Tree](#)
- [Displaying Intrusion Points](#)
- [Refining Intrusions](#)
- [Surfacing Options for Intrusions](#)
- [Applying a Trend to an Intrusion](#)
- [Clipping Values for Intrusions](#)
- [Interpolation Settings](#)

For a general introduction to how intrusions interact with other contact surfaces, see [Intrusion Contact Surfaces](#) in [Contact Surfaces](#).

Creating Intrusions

Lithology data is often the most reliable data source to use when building geological surfaces, and it is best to derive contact surfaces from lithology data when it is available. If no lithology data is available, you can create intrusions from other data in the project.

One thing to keep in mind for all intrusion contact surfaces is that an intrusion removes all the existing material on the younger side of the contact surface. Therefore:

- An intrusion should always have the younger side of its surface labelled with the intruded material. This is called the “interior lithology”.
- The older side will typically be labelled “Unknown” as an intrusion will usually displace multiple older lithologies. This is called the “exterior lithology”.

Intrusions from Lithology Contacts

Lithology data is often the most reliable data source to use when building geological surfaces, and it is best to derive contact surfaces from lithology data when it is available. There are two ways to create intrusions from lithology data:

- Using the base lithology column assigned when the model was created.
- Using other lithology information available in the project. This is useful when you have created an additional lithology column as part of correcting and working with the drillhole data. For example, if when building a geological model it becomes apparent that changes need to be made to the drillhole data, you can import additional data or create a new column using the split lithology, group lithology or interval selection tools.

To create a new intrusion from lithology contacts, right-click on the **Surface Chronology** object and select either **New Intrusion > From Base Lithology** or **New Intrusion > From Other Contacts**. The only difference in the two methods is that when creating an intrusion from other contacts, you must first select the lithology column from those available in the project and specify the **First lithology** and the **Second lithology**.

Select the intrusive lithology as the interior lithology. Other lithologies will be displayed in the **Exterior lithologies** list. Drag any younger lithologies to the **Ignore** list.

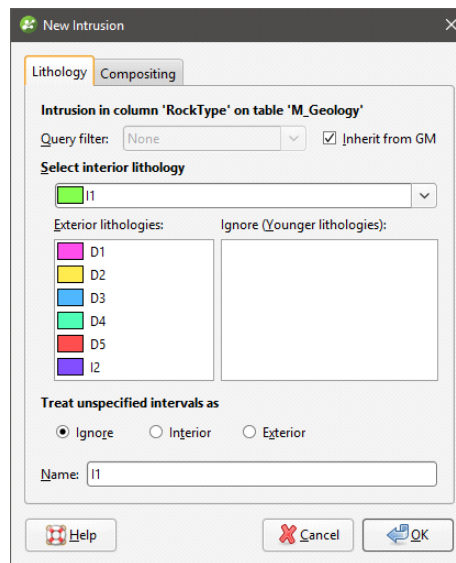

Unspecified intervals are intervals that have no data. By default, unspecified intervals are ignored when creating an intrusion, but you can also treat them as the interior lithology or as exterior lithologies.

Sometimes intrusive boundaries are poorly defined, with fragments of country rock intermixed with the intrusive body. This can result in very small segments near the edges of the intrusion. Modelling the fine detail is not always necessary, and so compositing can be used to smooth these boundaries. Compositing parameters are set in the **Compositing** tab:

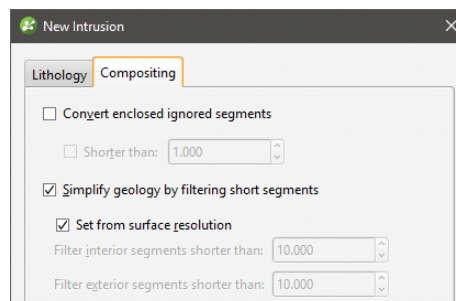

The settings in this tab are described in [Category Composites](#).

Click **OK** to create the intrusion, which will be added to the project tree as part of the **Surface Chronology** object.

Intrusions from Other Data

If suitable lithology data is not available, intrusions can be created from other data in the project, such as GIS data, structural data, points, polylines and surfaces. The steps for creating intrusions from other data are similar, regardless of the data used to create the surface:

- Right-click on the **Surface Chronology** and select one of the data types from the **New Intrusion** menu.

- Select the data object that will be used to define the surface. This must already be in the project, unless you are using a polyline, in which case you are given the option to create a new polyline.
- Select the **First lithology** and **Second lithology**. These are the lithologies that will be assigned to each side of the contact surface. The lithologies you can choose from are those defined for the geological model in the **Lithologies** object (see [Model Lithologies](#)).
- Set whether the **First lithology** is older or younger than the **Second lithology**. Leapfrog Geo will, by default, put the younger side of a contact surface up, but this can be changed later.

Here, a points data object is being used to create an intrusion:

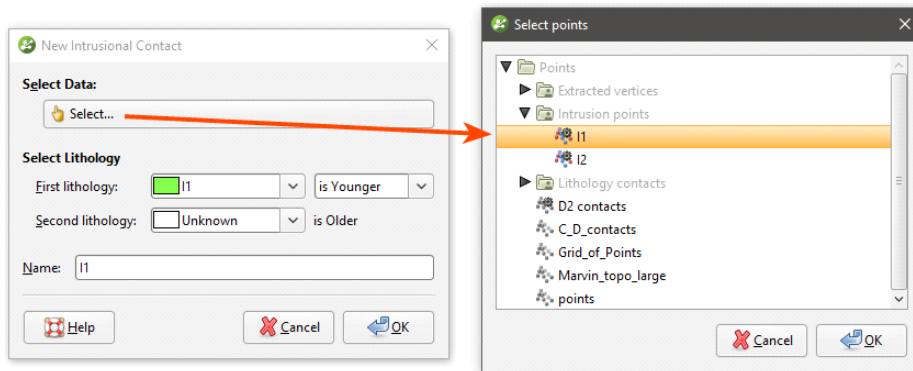

For polylines, you first set the lithologies and the younging order:

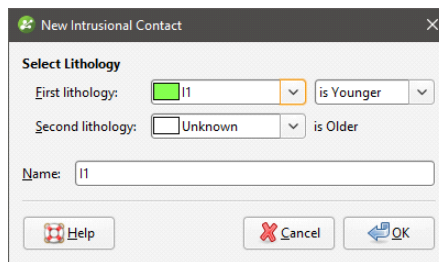

Click **OK** to move on to the next step:

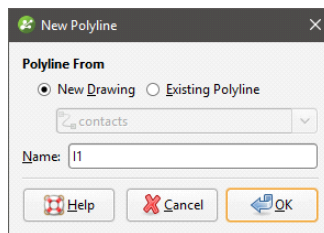

You can draw the polyline in the scene directly by selecting the **New Drawing** option. You can also use any polyline in the project by selecting the **Existing Polyline** option. You can then select the required polyline from the list.

The new intrusion will appear in the project tree under the **Surface Chronology**. Add the contact surface to the scene to view it and check that it is oriented correctly.

Expand the surface in the project tree to see how it was made.

If creating a surface from a new polyline, the polyline will not be able to be used elsewhere in the project unless it has been shared. To share the polyline, expand the contact surface in the

project tree, right-click on the polyline and select **Share**. The polyline will then be available elsewhere in the project.

As further refinements are made to the surface, that information will also be added to the contact surface in the project tree.

Intrusions in the Project Tree

The name Leapfrog Geo automatically assigns to an intrusion is the name of the intrusive lithology. In the project tree, expand the intrusion to see how it was made:

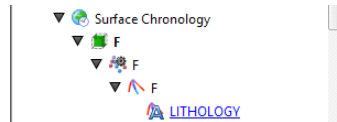

Double-click on the intrusion to edit it. Double-click on the points object (🔗) to edit the intrusion lithology, change compositing parameters and change point generation options.

As further refinements are made to the surface, that information will also be added to the project tree. See [Refining Intrusions](#) below for more information.

Displaying Intrusion Points

When you view the intrusion points in the scene, you can display only the contact points or all the points used in creating the intrusion. To display all points, click on the points object (🔗) in the shape list and tick the box for **Show volume points**. Here, only the contact points are displayed:

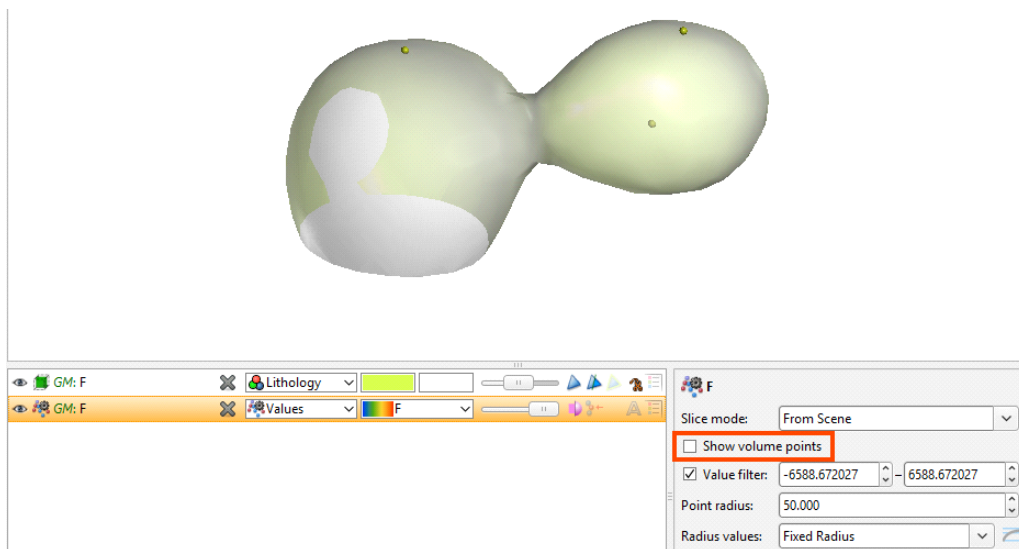

When the volume points are displayed, points with negative values are those outside the surface, while points with positive values are those inside:

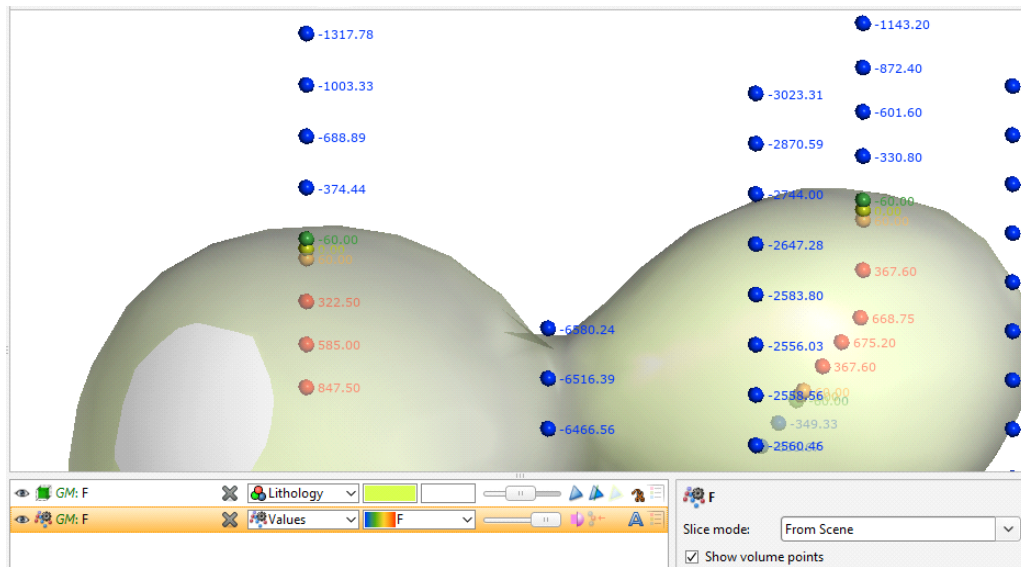

You can change the way intrusion points are generated by double-clicking on the points object () in the project tree. See [Intrusion Point Generation Parameters](#).

Refining Intrusions

You can refine intrusions in several ways:

- Add other data. Right-click on the surface to see the options available, which will depend on how the surface was created. See [Adding Data to Surfaces](#) for more information.
- Edit the surface with a polyline. Right-click on the surface in the project tree and select either **Edit > With Polyline**. See [Editing Surfaces with Polylines](#) for more information.
- Edit the surface using structural data. Right-click on the surface and select **Edit > With Structural Data**. See [Editing Surfaces with Structural Data](#) for more information.

To edit an intrusion's settings, double-click on it in the project tree. In the **Lithologies** tab, change the lithologies assigned to each side of the surface, if required.

Surfacing Options for Intrusions

Surfacing options for an intrusion can be changed by double-clicking on the surface in the project tree and then clicking on the **Surfacing** tab. There are additional settings related to boundary filtering and snapping to data in the **Inputs** tab.

Boundary Filtering

When data objects are added to a surface, there are two ways to handle the data that lies outside the surface's boundary:

- Filter the data. The surface is only influenced by the data that falls inside the surface's boundary.

- Leave the data unfiltered. The surface is influenced by the data both inside and outside the surface's boundary.

The boundary of an intrusion can be the geological model boundary or a fault block boundary.

The **Boundary filter** setting determines how data used to define the surface is filtered:

- **Off.** Data is not filtered.
- **All data.** All data is filtered.
- **Drilling only.** Only drillhole data and data objects derived from drillhole data are filtered.
- **Custom.** Only the data objects specified in the **Inputs** tab are filtered.

Snapping to Data

Often, surfaces should honour drillhole data and treat data objects such as polylines and GIS data as interpretations, as discussed in [Honouring Surface Contacts](#).

There is a **Snap to data** setting for a geological model as a whole that is set in the **Geological Model > General** tab (see [Editing a Geological Model](#)). **Snap to data** can also be set on a surface-by-surface basis by double-clicking on the surface in the project tree and then clicking on the **Surfacing** tab.

For individual contact surfaces, the options are:

- **Inherit from GM.** The setting for the geological model as a whole is used. This is the default setting.
- **Off.** Surfaces do not snap to the data used to create them.
- **All data.** Surfaces snap to all data within the **Maximum snap distance**, which includes drillhole data and any data added to the surfaces.
- **Drilling only.** Surfaces snap to drillhole data and data objects derived from drillhole data within the **Maximum snap distance** but not to other data used to modify the surfaces.
- **Custom.** Surfaces snap to the data objects indicated in the **Inputs** tab for each surface.

Take care in enabling snapping and in selecting what data the surface will snap to, as the more data you include, e.g. by setting a large **Maximum snap distance** or selecting **All data** for **Snap to data**, the greater the possibility that errors in the data or assumptions inherent in interpretations (e.g. polylines) will cause distortions in the meshes. If you do enable snapping, it is best to snap only to drilling data. See [Honouring Surface Contacts](#) for more information on these settings.

If you need a surface to honour drillhole data but treat other data objects as interpretations, select **Drilling only**. To honour some data objects while treating others as interpretations, select **Custom**, then click on the **Inputs** tab to enable snapping for individual objects.

Surface Resolution

See [Surface Resolution for a Geological Model](#) for information about the surface resolution settings in the **Surfacing** tab.

Clicking **Additional options** adds **Value Clipping** and **Interpolant** tabs to the window and also allows the use of a structural trend in the **Trend** tab:

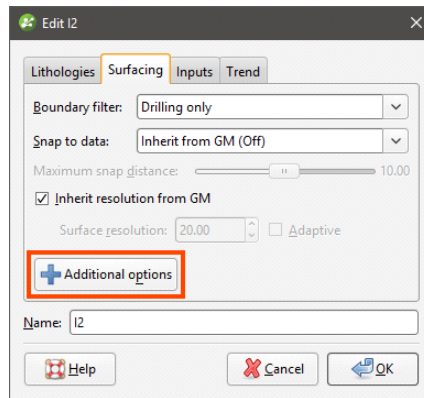

These are described in [Applying a Trend to an Intrusion](#), [Clipping Values for Intrusions](#) and [Interpolation Settings](#) below.

Applying a Trend to an Intrusion

There are two ways to change the trend for an intrusion:

- Right-click on the surface in the project tree and select **Adjust Surface**.
- Double-click on the surface in the project tree and then click on the **Trend** tab.

See [Global Trends](#) for more information.

You can also use a structural trend for an intrusion. To do this, click the **Additional options** button in the **Surfacing** tab, then click on the **Trend** tab.

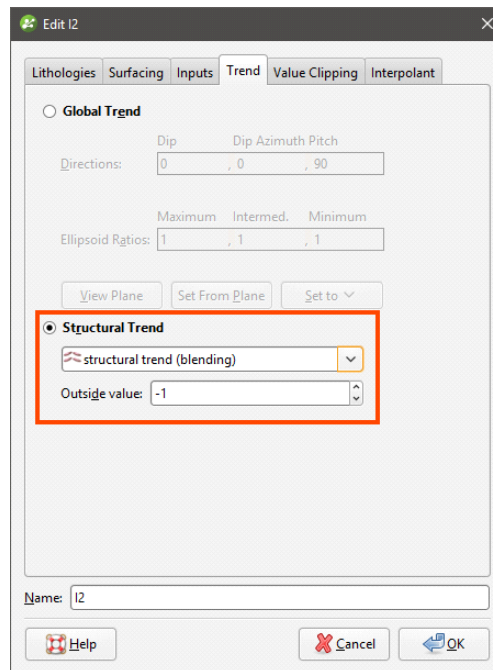

Click on **Structural Trend**, then select the required trend from the list. See [Structural Trends](#) for more information.

Clipping Values for Intrusions

You can change settings for intrusions by double-clicking on the contact surface in the project tree. The **Value Clipping** tab is only available for intrusion contact surfaces.

In the **Value Clipping** tab, you can manipulate the data distribution by clipping the data:

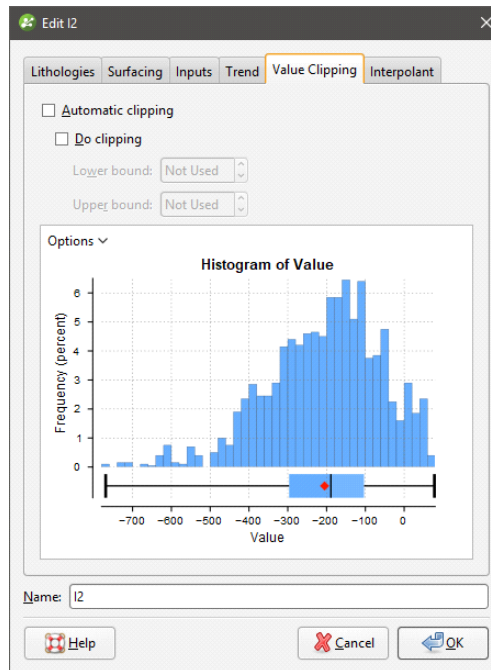

Clipping caps values that are outside the range set by the **Lower bound** and **Upper bound** values. For example, if you change the **Upper bound** from 16.00 to 10.00, distance values above 10.00 will be regarded as 10.00.

The **Automatic clipping** setting has different effects based on whether a global trend or structural trend is set in the **Trend** tab:

- When a global trend is applied, Leapfrog Geo automatically clips the values. That is, the **Automatic clipping** setting is **Do clipping** and Leapfrog Geo sets the **Lower bound** and **Upper bound** from the data. To disable clipping, untick **Automatic clipping**, then untick **Do clipping**. To change the **Lower bound** and **Upper bound**, untick **Automatic clipping**, then change the values.
- When a structural trend is applied, Leapfrog Geo automatically does not clip the values. To clip values, untick **Automatic clipping**, then tick **Do clipping**. Again, Leapfrog Geo sets the **Lower bound** and **Upper bound** values from the data and you can change them, if required.

Interpolation Settings

You can change settings for an intrusion by double-clicking on the intrusion in the project tree and clicking on the **Interpolant** tab. For more information on the settings in this tab, see:

- [Interpolant Functions](#)
- [The Spheroidal Interpolant Function](#)

- [The Linear Interpolant Function](#)

Veins

This topic describes creating and editing veins. It is divided into:

- [Creating Veins](#)
- [Veins in the Project Tree](#)
- [Displaying Veins](#)
- [Refining Veins](#)
- [Surfacing Options for Veins](#)
- [The Vein Reference Surface](#)
- [The Vein Boundary](#)
- [Editing Vein Segments](#)

For a general introduction to how veins interact with other contact surfaces, see [Vein Contact Surfaces](#) in [Contact Surfaces](#).

A vein is a type of contact surface that removes existing lithologies and replaces them with the vein lithology within the boundaries defined by hangingwall and footwall surfaces constructed from selected input data. A reference surface is defined that is the best fit for the hangingwall and footwall surfaces. The reference surface can be curved or planar.

Creating Veins

Options for creating veins are:

- From lithology data, using the base lithology used to define the geological model or other contacts available in the project. See [Veins From Lithology Contacts](#) below.
- From GIS vector data, point data and polylines. See [Veins From Other Data](#) below.
- Creating a vein system. This results in a single lithology that represents all the veins in a model. Veins and their interactions are defined within the vein system. See [Vein Systems](#).

Veins From Lithology Contacts

To create a new vein from lithology contacts, right-click on the **Surface Chronology** object and select either **New Vein > From Base Lithology** or **New Vein > From Other Contacts**. The only difference in the two methods is that when creating a vein from other contacts, you must first select the lithology column from those available in the project and specify the **Vein lithology** and **Outside lithology**.

In the **New Vein** window, select the **Vein lithology**:

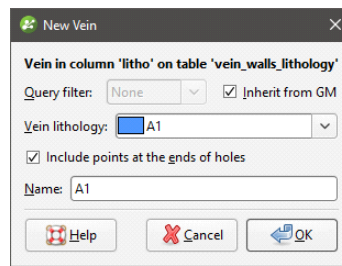

When extracting the hangingwall and footwall points, Leapfrog Geo automatically includes points at the ends of the drillholes. To exclude these points, untick the **Include points at the ends of holes**. Once the vein has been created, this setting can be changed by double-clicking on the vein segments object (📍) in the project tree.

Click **OK** to create the vein, which will be added to the project tree as part of the **Surface Chronology** object.

Veins From Other Data

If suitable lithology data is not available, veins can be created from other data in the project, such as GIS data, points and polylines. The steps for creating veins from other data are similar, regardless of the data used to create the surface:

- Right-click on the **Surface Chronology** and select one of the data types from the **New Vein** menu.
- Select the data objects for the **Hangingwall** and **Footwall**. These objects must already be in the project.
- Select the **Vein lithology** and the **Outside lithology**. The lithologies you can choose from are those defined for the geological model in the **Lithologies** object (see [Model Lithologies](#)).

Here, points data is being used to create a vein:

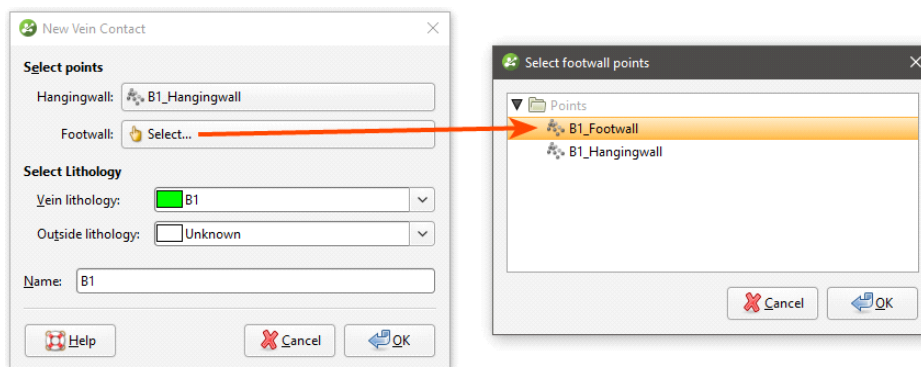

Select points data objects for both the **Hangingwall** and **Footwall**, then click **OK** to create the new vein. The new contact surface will appear in the project tree under the **Surface Chronology**. Expand the vein in the project tree to see how it was made.

Veins in the Project Tree

Veins are stored in the project tree as part of the **Surface Chronology** object. Further modifications can be made to the vein by working on the objects that make up the vein. Expand the vein in the project tree to view these objects.

Here, the hangingwall and footwall surfaces and points are displayed in the scene for a vein defined from lithology data. The reference surface (yellow) and the vein segments (red and blue cylinders) used to create the vein are also shown:

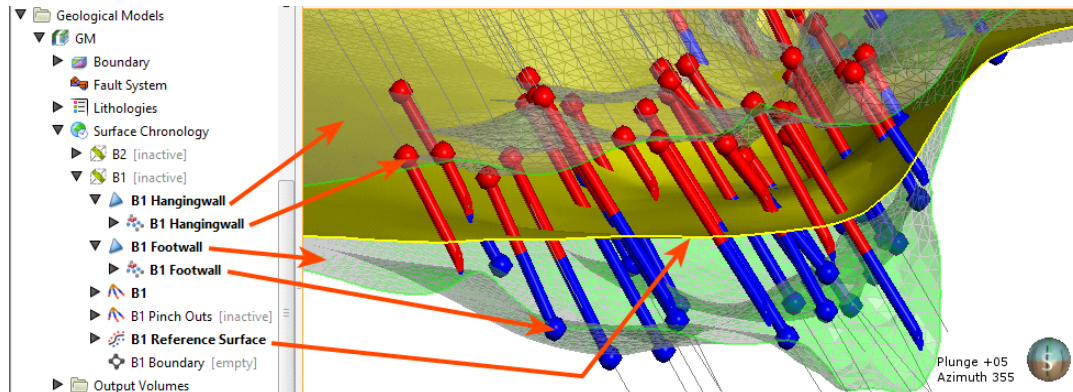

This vein is made up of:

- Hangingwall and footwall surfaces (🔺), which, when expanded, show the hangingwall and footwall data objects used to create the surfaces.
 - Export hangingwall and footwall surfaces as described in [Exporting Meshes](#) and [Exporting an Elevation Grid](#).
 - Add points and GIS vector data to the meshes by right-clicking on them and selecting **Add**.
 - Edit the hangingwall and footwall surfaces with polylines by right-clicking on the surface and selecting one of the **Edit** options.
 - Change contact honouring and boundary filtering options as described in [Surfacing Options for Veins](#) below.
- Vein segments and pinch out segments (📏) extracted from drillhole data. These are only included when a vein is created from lithology contacts.
- A reference surface (📐) calculated as the best fit surface using the hangingwall and footwall surfaces.
 - The reference surface can be curved or planar.
 - You can add points, GIS vector data and polylines to a curved reference surface.
 - If a curved reference surface is made up of multiple objects, you can switch between the objects and change how they are filtered in order to see the effects on the vein.
- A boundary object (📍), which is empty when the vein is first created.

It is not possible to add structural data or polylines with orientation information to the hangingwall, footwall and reference surfaces. If you edit these surfaces with a polyline, your options for editing the polyline will be limited.

Displaying Veins

You can change the way the different objects that make up the vein are displayed using options in the shape list:

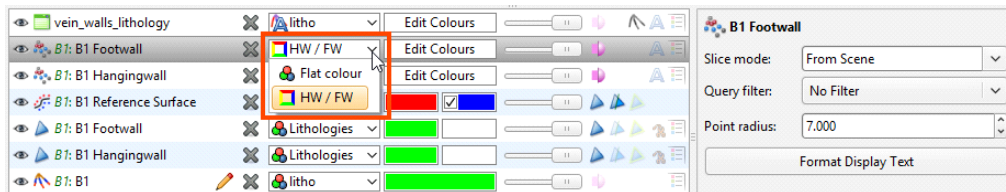

Refining Veins

To edit a vein’s settings, double-click on it in the project tree. In the **Lithologies** tab, change the lithologies assigned to each side of the surface, if required. For information on the settings in the **Surfacing** and **Inputs** tabs, see [Surfacing Options for Veins](#) below.

Surfacing Options for Veins

Surfacing options for veins can be changed by double-clicking on the surface in the project tree and then clicking on the **Surfacing** tab. There are additional settings related to boundary filtering and snapping to data in the **Inputs** tab.

Boundary Filtering

When data objects are added to a surface, there are two ways to handle the data that lies outside the surface’s boundary:

- Filter the data. The surface is only influenced by the data that falls inside the surface’s boundary.
- Leave the data unfiltered. The surface is influenced by the data both inside and outside the surface’s boundary.

The boundary of a vein can be the geological model boundary or a fault block boundary.

The **Boundary filter** setting determines how data used to define the surface is filtered:

- **Off**. Data is not filtered.
- **All data**. All data is filtered.
- **Drilling only**. Only drillhole data and data objects derived from drillhole data are filtered.
- **Custom**. Only the data objects specified in the **Inputs** tab are filtered.

The **Filter segments by boundary** setting in the **Inputs** tab is enabled by default when the **Boundary filter** setting in the **Surfacing** tab is **All data** or **Drilling only**. When **Filter segments**

by **boundary** is enabled, the vein surface will only be influenced by the segments that falls inside the vein boundary.

Snapping to Data

Often, surfaces should honour drillhole data and treat data objects such as polylines and GIS data as interpretations, as discussed in [Honouring Surface Contacts](#).

There is a **Snap to data** setting for a geological model as a whole that is set in the **Geological Model > General** tab (see [Editing a Geological Model](#)). **Snap to data** can also be set on a surface-by-surface basis by double-clicking on the surface in the project tree and then clicking on the **Surfacing** tab.

For individual contact surfaces, the options are:

- **Inherit from GM.** The setting for the geological model as a whole is used. This is the default setting.
- **Off.** Surfaces do not snap to the data used to create them.
- **All data.** Surfaces snap to all data within the **Maximum snap distance**, which includes drillhole data and any data added to the surfaces.
- **Drilling only.** Surfaces snap to drillhole data and data objects derived from drillhole data within the **Maximum snap distance** but not to other data used to modify the surfaces.
- **Custom.** Surfaces snap to the data objects indicated in the **Inputs** tab for each surface.

Take care in enabling snapping and in selecting what data the surface will snap to, as the more data you include, e.g. by setting a large **Maximum snap distance** or selecting **All data** for **Snap to data**, the greater the possibility that errors in the data or assumptions inherent in interpretations (e.g. polylines) will cause distortions in the meshes. If you do enable snapping, it is best to snap only to drilling data. See [Honouring Surface Contacts](#) for more information on these settings.

If you need a surface to honour drillhole data but treat other data objects as interpretations, select **Drilling only**. To honour some data objects while treating others as interpretations, select **Custom**, then click on the **Inputs** tab to enable snapping for individual objects.

Surface Resolution

Note that although you can change the **Surface resolution** for a vein, the **Adaptive** option is not available, even when the resolution for the geological model is set to be **Adaptive**.

Vein Thickness

Veins have two thickness settings that force the vein to maintain a minimum or maximum thickness. If footwall and hangingwall points are in pairs, it is not usually necessary to set the **Minimum thickness** or **Maximum thickness**.

- If the vein intersects itself, set the **Minimum thickness** to a value that is less than the minimum distance between any two contact points.
- If the vein widens out toward the edges of the geological model set the **Maximum thickness** to a value that limits the effects of long segments.

If the **Pinch out** option is enabled, you will not be able to set the **Minimum thickness**.

If you set the **Maximum thickness** and **Pinch out**, the **Pinch out** is applied before the **Maximum thickness**.

Note that if **Snap to data** is enabled, snapping occurs after the vein thickness has been calculated. If it appears that the vein surface is not honouring the thickness setting, check what data the surface is snapping to.

Vein Pinch Out

Vein walls can be set to pinch out where drillhole data indicates they do not occur. This is achieved by creating 'outside' intervals on drillholes that do not have an interior vein segment. These intervals are then flipped with respect to interior vein intervals, which, in effect means the footwall and hangingwall orientation has the opposite sense to the nearest interior intervals. This forces the hangingwall and footwall surfaces to cross, thereby pinching out.

The **Pinch out** option is disabled when a vein is first created. To enable it, double-click on the vein in the project tree and click on the **Surfacing** tab. Tick the box for **Pinch out**. Click **OK** to process the changes. The vein will be updated and pinch out points (📍) will be added to the vein in the project tree.

For this vein, the surface occurs even where the vein lithology (green cylinders) does not occur and terminates at the boundary of the geological model:

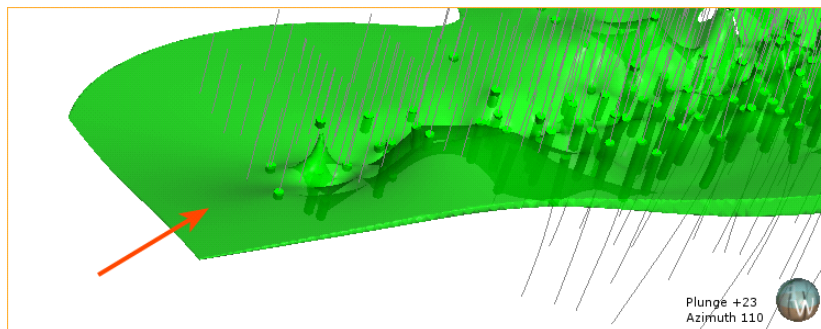

When the vein is set to pinch out, it tapers out where the vein lithology does not occur:

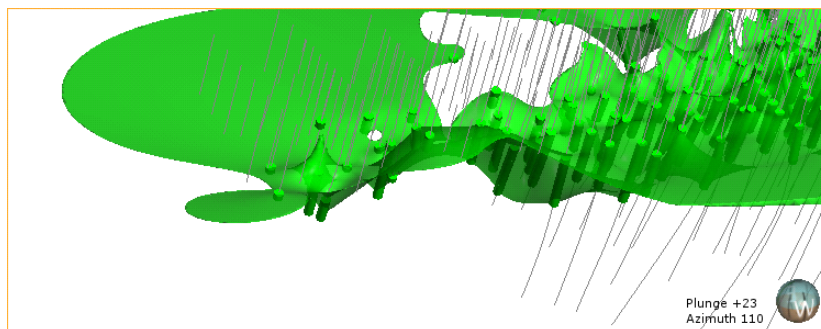

You can change how much the vein pinches out by excluding some pinch out segments. To do this, right-click on the pinch out segments (📌) in the project tree and select **Edit in Scene**. The **Pinch Out Properties** window will appear in the scene. Click on a segment to view information about it and set it to be **Excluded**, if required. Note that the segments displayed in the scene below are the pinch out segments rather than the drillhole segments shown in earlier scenes. The grey segments are excluded and the currently selected segment is highlighted in the scene:

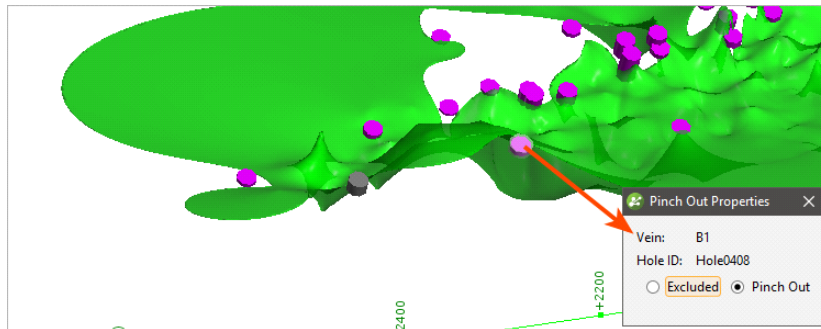

Click the **Save** button (💾) to view the effect of the excluded pinch out segments on the vein. Excluding the two segments results in the vein terminating at the boundary of the geological model:

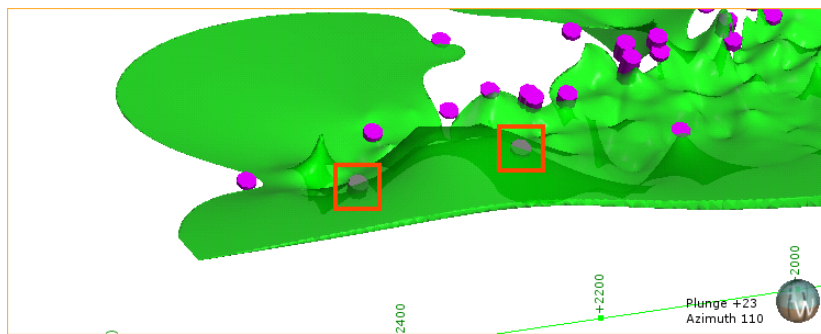

The Vein Reference Surface

A vein includes a reference surface (📐) that is the best fit for the objects that make up the hangingwall and footwall surfaces. There are two types of reference surface.

- **Curved.** A curved reference surface can be used to make a vein follow the medial trend of the source data, which leads to a more natural modelled shape. This is the type of reference surface used by default for veins created from lithology data. A curved reference surface can be used for veins created from other types of data by adding data to the reference surface, as described in [Adding Data to the Reference Surface](#).
- **Planar.** A planar reference surface is simply the best linear fit between the hangingwall and footwall surfaces. See [Using a Planar Reference Surface](#).

To adjust the reference surface (📐), double-click on it in the project tree or right-click on it and select **Open**. The **Reference Surface** window will appear, showing the data used to for the reference surface. This is the reference surface for a vein created from lithology data, and so the midpoints for the vein lithology are used as **Input values**:

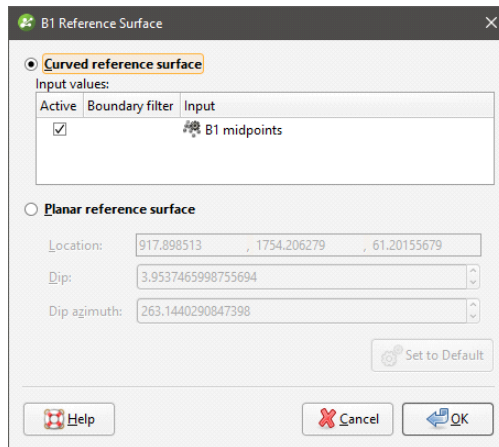

Boundary filtering for the midpoints used to create a curved reference is controlled by the setting for the vein itself. See [Boundary Filtering](#) in [Surfacing Options for Veins](#) for more information.

Adding Data to the Reference Surface

In order for a vein created from data other than lithology data to use a curved reference surface, other data must be added to it.

It is not possible to add structural data or polylines with orientation information to the reference surface. If you edit the reference surface with a polyline, your options for editing the polyline will be limited.

To add data, right-click on the reference surface in the project tree and select **Add** or **Edit**. Once you have added data, the **Curved reference surface** option will be enabled in the **Reference Data** window and the objects used to adjust the surface will appear in the list of **Input values**:

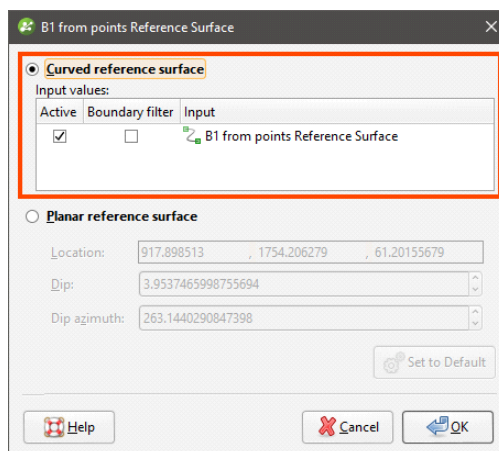

You can enable or disable the different data objects to see their effects on the vein by ticking and unticking the **Active** box.

The **Boundary filter** setting for each object determines whether or not the data that lies outside the reference surface's boundary is filtered.

- Tick **Boundary filter** so that the surface is only influenced by the data that falls inside the reference surface's boundary.
- Untick **Boundary filter** if you want the surface to be influenced by the data both inside and outside the reference surface's boundary.

Click **OK** to process the changes.

Using a Planar Reference Surface

Veins created from objects other than lithology data use a planar reference surface, and this option can also be selected for veins created from lithology data. To use a planar reference surface, select the **Planar reference surface** option in the **Reference Surface** window. The plane will be displayed in the scene, together with handles that can be used to adjust it:

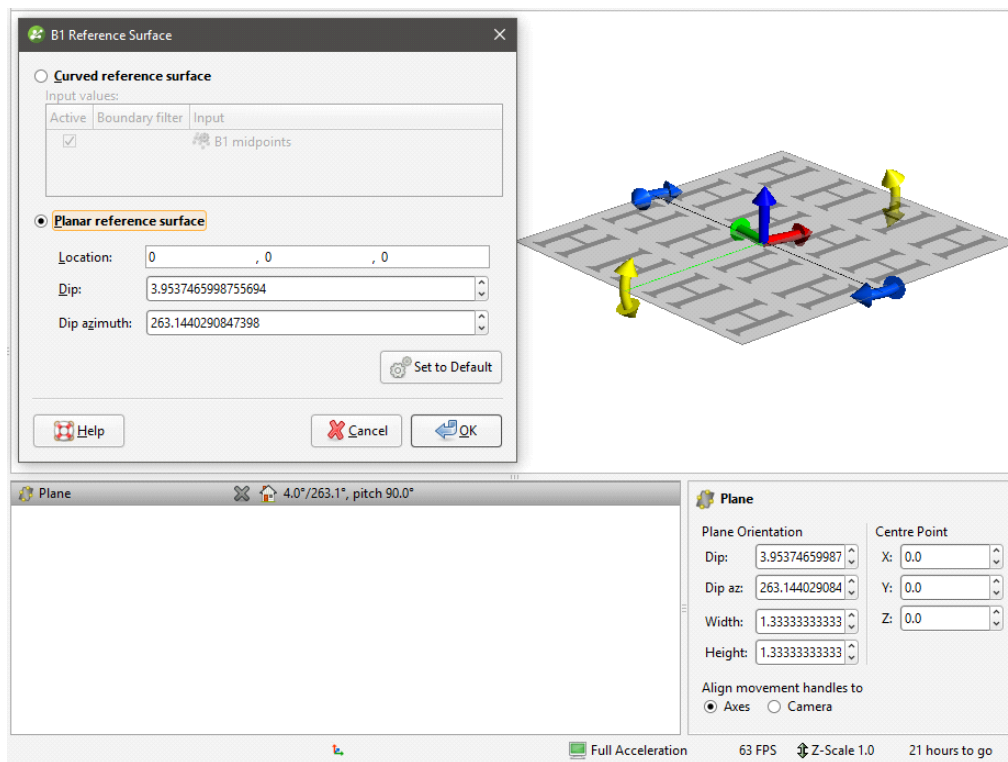

These handles work in the same manner as the moving plane controls, as described in [The Moving Plane](#).

Click **OK** to update the reference surface and view the results.

The Vein Boundary

Once a vein has been created, you can change its boundary by:

- [Adding a Polyline to the Vein Boundary](#)
- [Adjusting the Vein Boundary Plane](#)

Adding a Polyline to the Vein Boundary

To change the boundary using a polyline, right-click on the boundary object (📍) in the project tree and select **Edit**. The current vein boundary will appear in the scene, together with drawing controls. Begin drawing the new boundary, as described in [Drawing in the Scene](#), ensuring that the polyline drawn closes and does not intersect itself.

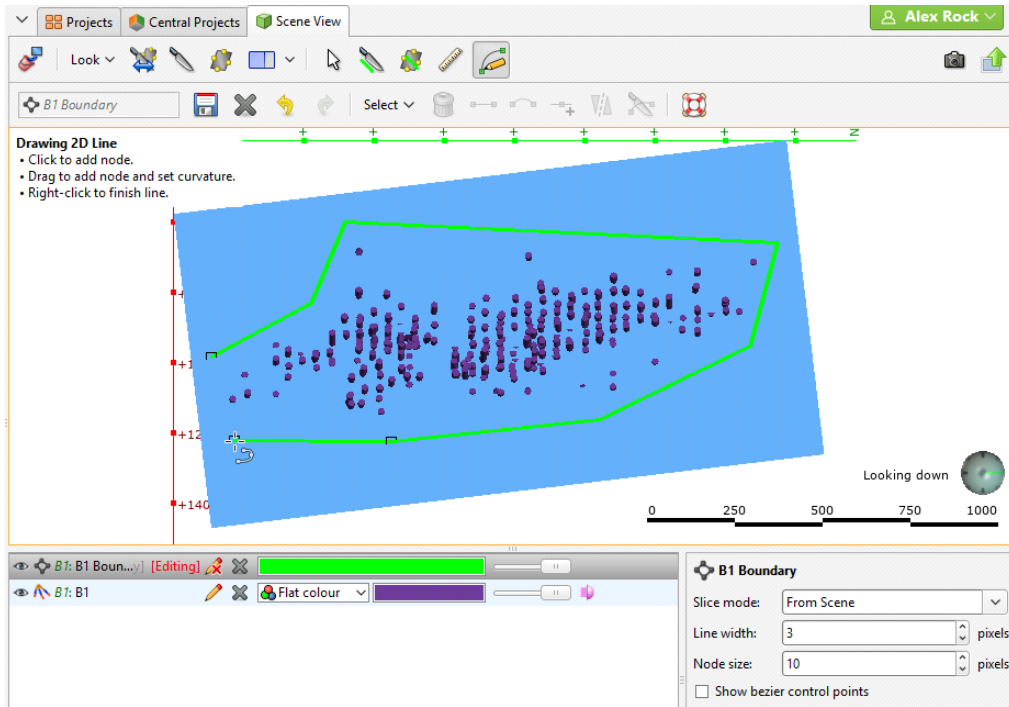

When you save the boundary, the vein will be updated to reflect the changes to the boundary. If you want to revert to the original boundary, right-click on the boundary object (📍) and select **Delete Polyline**.

Adjusting the Vein Boundary Plane

To adjust the boundary plane, right-click on the boundary object (📍) in the project tree and select **Adjust Plane**. The **Adjust Boundary Plane** window will appear and handles to adjust the plane will appear in the scene:

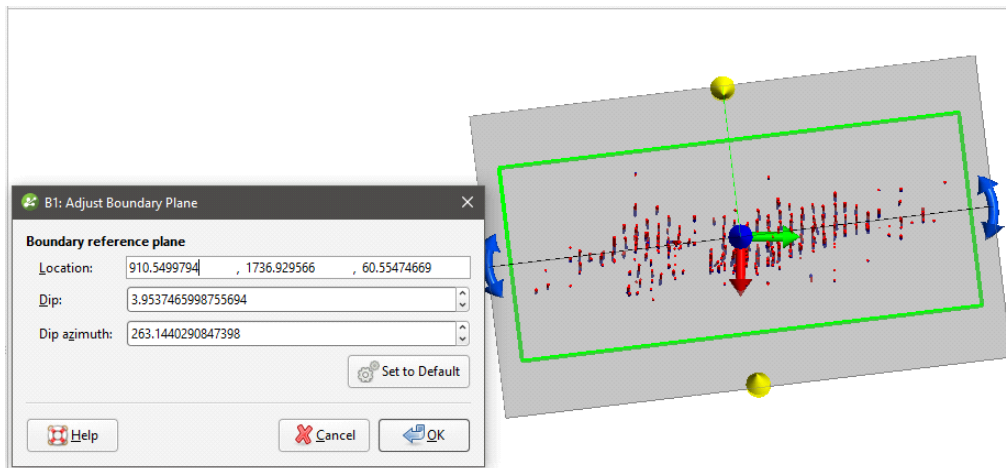

Click **OK** to apply the changes to the vein. To revert to the original boundary plane, right-click on the boundary object and select **Adjust Plane**. In the **Adjust Boundary Plane** window, click on the **Set to Default** button and click **OK**.

Editing Vein Segments

When a vein has been created from contact points, you can change the vein segment settings by double-clicking on the vein segments object (📁) in the project tree. This opens the **Edit Vein** window.

When extracting the hangingwall and footwall points, Leapfrog Geo automatically includes points at the ends of the drillholes. To exclude these points, untick the **Include points at the ends of holes**.

Vein Segment Orientation

If you need to change the orientation of individual vein segments, e.g. for curved veins, you can do this by right-clicking on the vein segments object (📁) in the project tree and selecting **Edit In Scene**. If the vein segments object is already in the scene, you can edit it by clicking the **Edit** button (✎) in the shape list.

The **Vein Segment Orientations** window will appear in the scene. Click on a vein segment to view information about that segment:

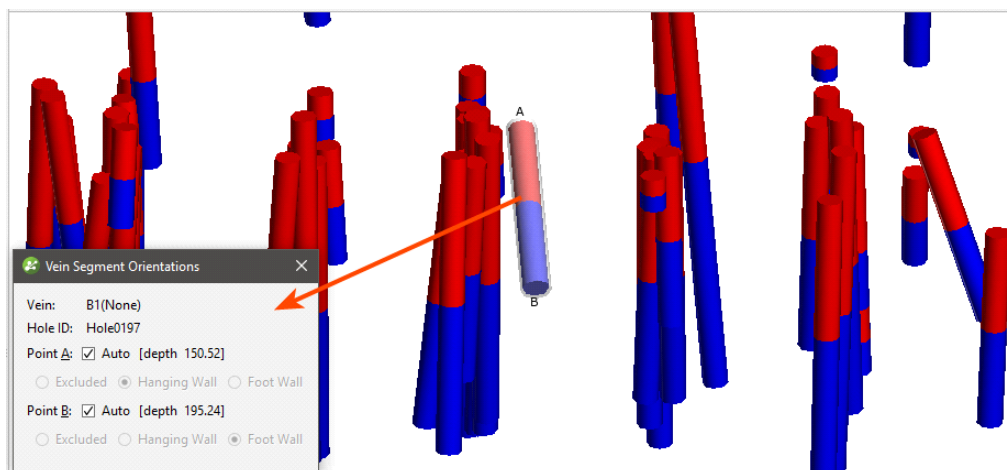

Points A and B are labelled in the scene and can be changed by unticking the box for each point and choosing whether to exclude the point or make it a hangingwall or footwall point. Once you have finished editing vein segments, click the **Save** button (💾).

If you wish to return to the default settings, ensure the **Auto** box is ticked for each point.

Vein Systems

This topic describes creating a vein system for a geological model. The topic is divided into:

- [Creating a Vein System](#)
- [Adding Veins to the Vein System](#)
- [Editing the Veins](#)

- [Changing Vein System Lithology Settings](#)
- [Setting Vein Interactions](#)

An alternative to defining veins one-by-one is to create a vein system. The vein system represents a single lithology within the geological model. For example, for a model of a sedimentary system cross-cut by vertical intersecting dykes, we could model the veins one-by-one, in which case each “vein” in the model is represented by a separate lithology:

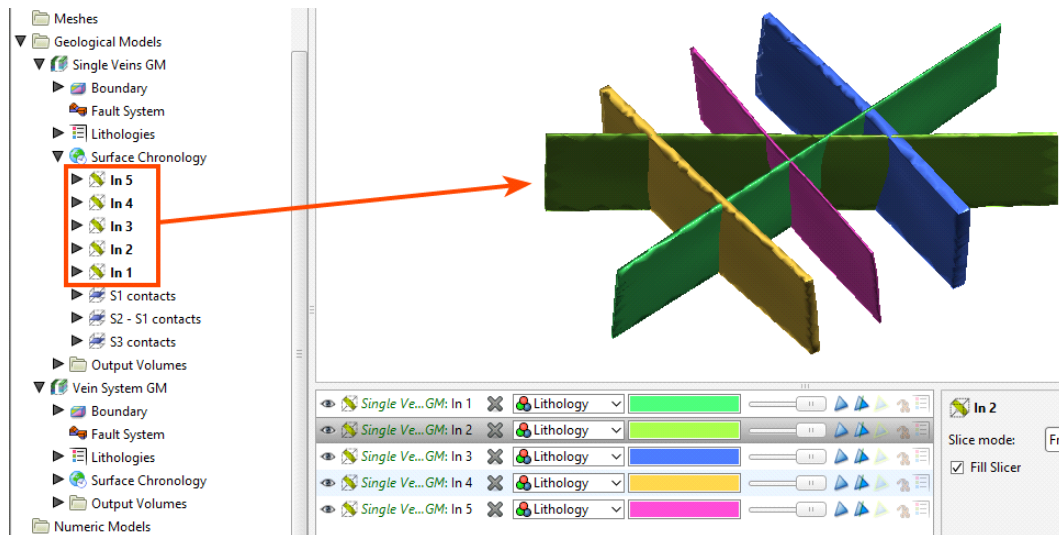

Modelled as a vein system, however, the veins are grouped into a vein system object (👉) that defines the lithology for the vein system as a whole:

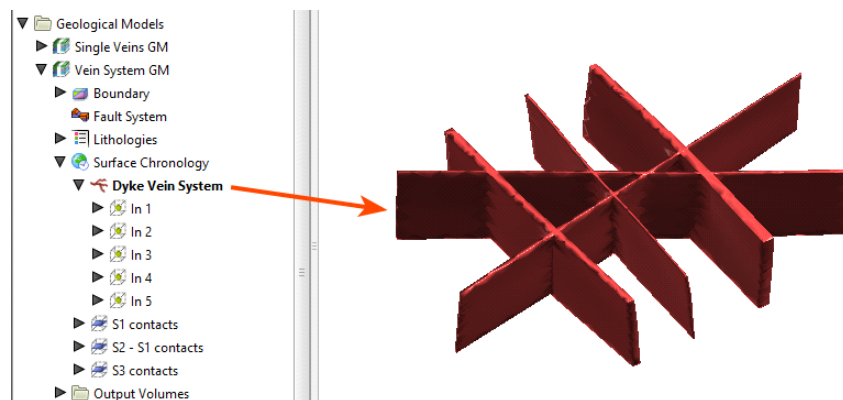

Note that the individual veins are part of the vein system.

The vein system defines how the veins interact, and veins can be added to it using the same techniques used to create individual veins.

Creating a Vein System

To create a vein system, right-click on the **Surface Chronology** and select **New Vein System**. In the window that appears, select the **Vein lithology**:

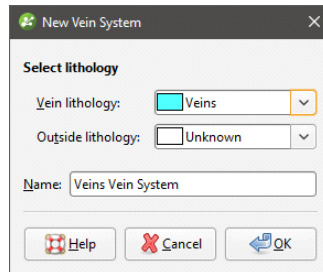

If the vein system contacts only one lithology, set the **Outside lithology**. Otherwise, leave **Outside lithology** set to Unknown.

Click **OK**. An empty vein system (🔍) will be added to the project tree under the **Surface Chronology**. Double-click on it to change the lithologies.

Adding Veins to the Vein System

Once the vein system has been created, you can create veins using the same techniques described in [Veins From Lithology Contacts](#) and [Veins From Other Data](#).

To add veins to the vein system, right-click on the vein system and select one of the **New Vein** options. Veins will appear in the project tree as part of the vein system object and can be expanded to show how they were created.

Editing the Veins

The techniques for editing vein system veins are the same as those for veins created one-by-one. See [Refining Veins](#).

Changing Vein System Lithology Settings

You can change the lithology settings for a vein system by double-clicking on the vein system (🔍) in the project tree. In the **Lithology** tab, change the **Vein lithology** or the **Outside lithology**.

Setting Vein Interactions

Once all the veins required have been created, you can start defining the interactions between them by double-clicking on the vein system (🔗), then clicking on the **Vein System** tab:

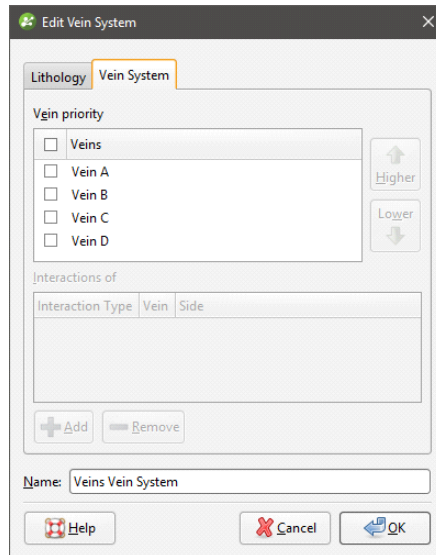

The veins appear in the list from highest priority to lowest. Organise the veins in chronological order before defining interactions.

The **Vein priority** determines which veins other veins can interact with. You cannot define an interaction for the highest priority vein in the list, and other veins in the list can interact only with those of higher priority.

Here, Vein B can only interact with Vein A, the higher priority vein:

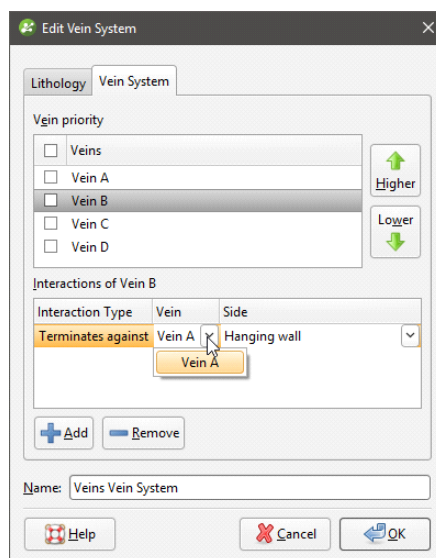

The lowest priority vein, Vein D, can interact with all the other veins in the system:

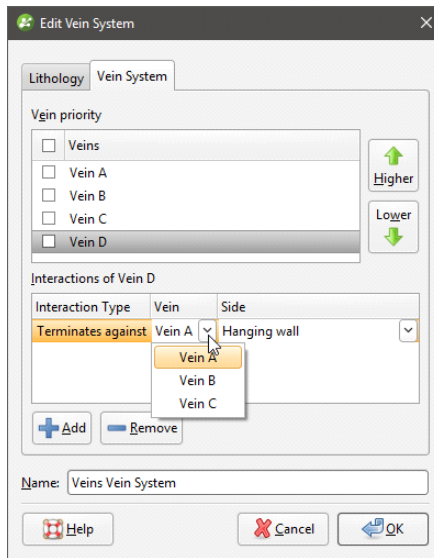

To define an interaction, click on a vein, then click the **Add** button. Add an interaction for each vein and then set the **Side** on which they interact.

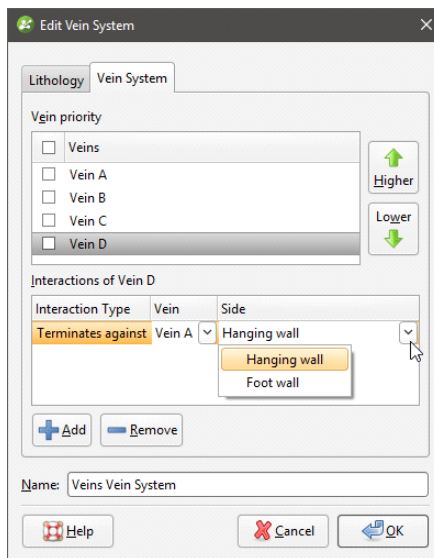

Once you have defined the required vein interactions, tick the box for each vein, then click **OK**. Add the **Vein System** object to the scene to check that the veins interact correctly.

You can also edit vein interactions by double-clicking on the individual veins, which opens the **Edit Vein** window:

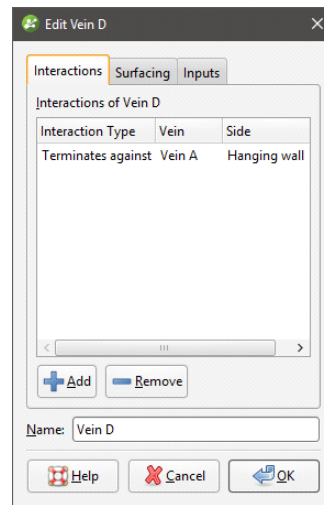

Veins and the vein system are not active in the geological model until the box is ticked for each vein in the **Edit Vein System** window and the vein system is enabled in the **Surface Chronology**. This means you can check the vein system without regenerating the geological model.

Stratigraphic Sequences

When you have a series of continuous layers in a geological model, you can model each layer separately, as part of a single stratigraphic sequence or using the offset surface tool. Modelling a stratigraphic sequence works best for sequences uniform in thickness with a consistent stacking order. If a layer varies in thickness, the contact surface may not match the contact points in some places. This will be a consideration when choosing whether to model layers as separate layers, as offset surfaces or as part of a stratigraphic sequence. For information on the offset surface tool, see [Offset Surfaces](#).

Once you have created a stratigraphic sequence, you can refine it by adding and removing layers and by adjusting the surfaces produced.

This topic describes using the stratigraphic sequence tool and is divided into:

- [Creating a Stratigraphic Sequence](#)
- [Editing the Stratigraphic Sequence](#)
- [Editing Individual Surfaces](#)

Creating a Stratigraphic Sequence

To create a stratigraphic sequence, right-click on the **Surface Chronology** object and select **New Stratigraphy**. The **New Stratigraphic Sequence** window will appear:

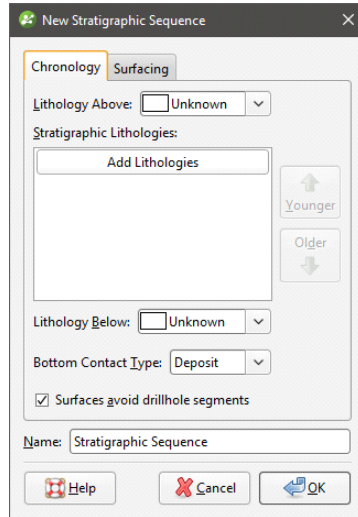

Select the lithologies at the top and bottom of the stratigraphic sequence. To do this, select the **Lithology Above** and **Lithology Below** from the lithologies available in the geological model:

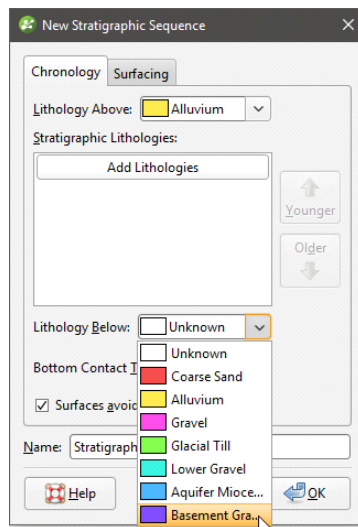

Next, click the **Add Lithologies** button to view available lithologies:

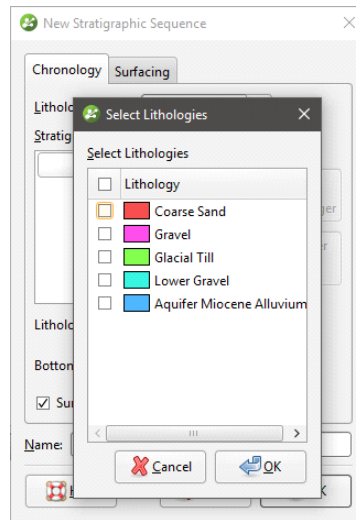

Select the lithologies that you want to use in the stratigraphic sequence, then click **OK** to add the layers to the **Stratigraphic Lithologies** list. Make sure they are arranged in the correct order.

In the **New Stratigraphic Sequence** window, select whether the **Bottom Contact Type** is an erosion or a deposit.

When the **Surfaces avoid drillhole segments** option is enabled, the surfaces in the stratigraphic sequence will not cut through intervals of lithologies that are selected for the stratigraphic sequence.

Stratigraphic sequences created in earlier versions of Leapfrog Geo (before 3.0) used only the contact information; intervals were ignored and stratigraphic sequence surfaces could cut through intervals. To upgrade a stratigraphic sequence created in earlier versions, edit the stratigraphic sequence to enable **Surfaces avoid drillhole segments**.

Next, click on the **Surfacing** tab to set the surfacing settings for each surface created for the sequence:

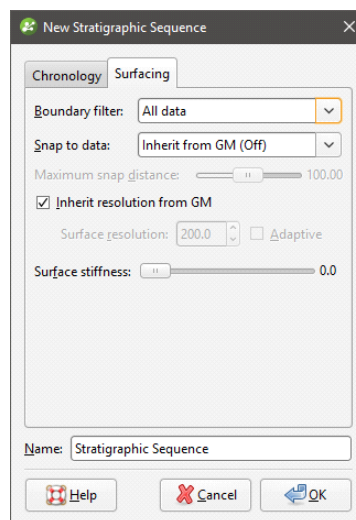

For the **Boundary filter** and **Snap to data** options, it is possible to override these settings for the individual contact surfaces that are part of the stratigraphic sequence. To do this, select

Custom. Once the stratigraphic sequence has been created, expand it in the project tree and double-click on each surface to change its surfacing options, as described in [Contact Honouring and Boundary Filtering for Individual Surfaces](#) below.

Boundary Filtering

When data objects are added to a surface, there are two ways to handle the data that lies outside the surface's boundary:

- Filter the data. The surface is only influenced by the data that falls inside the surface's boundary.
- Leave the data unfiltered. The surface is influenced by the data both inside and outside the surface's boundary.

The **Boundary filter** setting determines how data used to define the surface is filtered:

- **Off.** Data is not filtered.
- **All data.** All data is filtered.
- **Drilling only.** Only drillhole data and data objects derived from drillhole data are filtered.
- **Custom.** Only the data objects specified in the **Inputs** tab are filtered.

All contact surfaces that make up a stratigraphic sequence will inherit the **Boundary filter** setting from the stratigraphy unless **Boundary filter** is set to **Custom**.

Snapping to Data

There is a **Snap to data** setting for a geological model as a whole that is set in the **Geological Model > General** tab (see [Editing a Geological Model](#)). **Snap to data** can also be set on a surface-by-surface basis by double-clicking on the surface in the project tree and then clicking on the **Surfacing** tab.

For a stratigraphic sequence, the options are:

- **Inherit from GM.** The setting for the geological model as a whole is used. This is the default setting.
- **Off.** Surfaces do not snap to the data used to create them.
- **All data.** Surfaces snap to all data within the **Maximum snap distance**, which includes drillhole data and any data added to the surfaces.
- **Drilling only.** Surfaces snap to drillhole data and data objects derived from drillhole data within the **Maximum snap distance** but not to other data used to modify the surfaces.
- **Custom.** Surfaces snap to the data objects indicated in the **Inputs** tab for each surface.

Take care in enabling snapping and in selecting what data the surface will snap to, as the more data you include, e.g. by setting a large **Maximum snap distance** or selecting **All data** for **Snap to data**, the greater the possibility that errors in the data or assumptions inherent in interpretations (e.g. polylines) will cause distortions in the meshes. If you do enable snapping, it is best to snap only to drilling data. See [Honouring Surface Contacts](#) for more information on these settings.

All contact surfaces that make up a stratigraphic sequence will inherit the **Snap to data** setting from the stratigraphy unless **Snap to data** is set to **Custom**.

Surface Stiffness

The **Surface Stiffness** controls the smallest bend a surface will make, where a higher value will result in a smoother surface that bends less. The default value is 0, which is no stiffening.

Click **OK** to create the stratigraphy, which will be added to the project tree as part of the **Surface Chronology** object.

Editing the Stratigraphic Sequence

The objects that make up the stratigraphic sequence include the generated contact surfaces and any points that result in pinch-out errors:

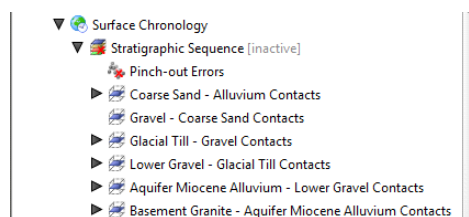

Correcting Pinch-Out Errors

Add the pinch-out errors object (🔍) to the scene to view the points that are causing errors. To find out more about the errors, right-click on the sequence and select **List Errors**.

In the **Stratigraphic Errors** window, information is provided about the different errors that occur in the stratigraphic sequence, with pinch-out errors and other errors listed separately:

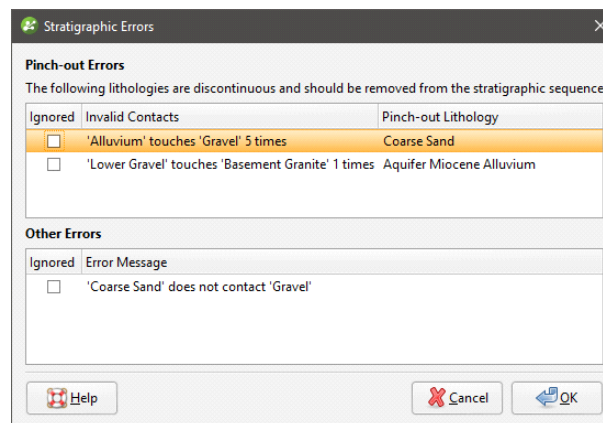

Use this information, together with the pinch-out error points, to either remove lithologies from the sequence or adjust surfaces using any of the tools available for individual surfaces, as described in [Editing Individual Surfaces](#) below.

Remove lithologies from the sequence by double-clicking on the sequence in the project tree, then reorganising the lithologies in the **Chronology** tab. For example, here, the pinch-out errors shown in the window above have been corrected by removing the affected surfaces from the sequence and changing the **Lithology Above** and **Lithology Below**:

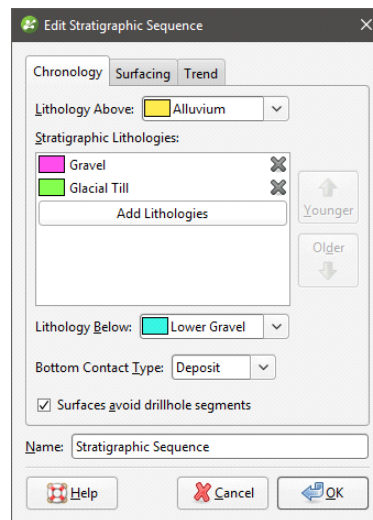

You can also ignore an error by ticking the **Ignored** box in the **Stratigraphic Errors** window.

Surfacing Options

To change a stratigraphic sequence's surfacing options, double-click on the sequence in the project tree and click on the **Surfacing** tab. See [Boundary Filtering](#) and [Snapping to Data](#) above for more information on the settings in this tab. Note that boundary filtering and snap settings can also be set for the individual surfaces that make up the stratigraphic sequence, which is described in [Contact Honouring and Boundary Filtering for Individual Surfaces](#) below.

Applying a Trend

To apply a global trend to a stratigraphic sequence either right-click on it in the project tree and select **Adjust Surface** or double-click on the stratigraphic sequence and then click on the **Trend** tab. You can then apply a trend to the surface as described in [Global Trends](#).

Editing Individual Surfaces

Individual surfaces that make up a stratigraphic sequence can be modified by:

- [Contact Honouring and Boundary Filtering for Individual Surfaces](#)
- [Adding Data to Individual Surfaces](#)
- [Editing Surface Contacts](#)

Contact Honouring and Boundary Filtering for Individual Surfaces

There are general boundary filtering and snap settings for the stratigraphic sequence as a whole, but it is possible to override these settings for the individual surfaces that are part of the stratigraphic sequence. To do this, first double-click on the stratigraphic sequence itself, then click on the **Surfacing** tab.

- To change boundary filtering for an individual surface, **Boundary filter** must be set to **Custom** for the stratigraphic sequence.
- To change the snap setting for an individual surface, **Snap to data** must be set to **Custom** for the stratigraphic sequence.

Next, double-click on an individual surface in the project tree. The window that appears shows all the data objects used to create the surface:

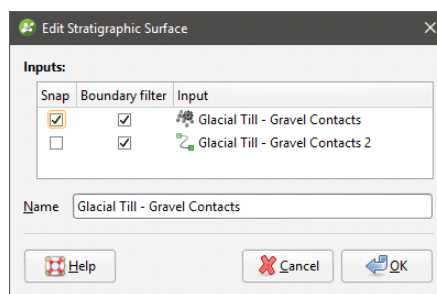

See [Boundary Filtering](#) and [Snapping to Data](#) for more information.

Adding Data to Individual Surfaces

You can also refine the individual surfaces in a stratigraphic sequence in several ways:

- Add other data. Right-click on the surface to see the options available, which will depend on how the surface was created. See [Adding Data to Surfaces](#) for more information.
- Edit the surface with a polyline. Right-click on the surface in the project tree and select either **Edit > With Polyline**. See [Editing Surfaces with Polylines](#) for more information.

It is not possible to add structural data or polylines with orientation information to individual surfaces in a stratigraphic sequence. If you edit a surface with a polyline, your options for editing the polyline will be limited.

Editing Surface Contacts

You can edit the contacts used to generate the surface by expanding the contact surface in the project tree and double-clicking on the points object (*). See [Extracting Contact Points from Drillhole Data](#) for more information on the settings in the **Edit Contacts** window.

Offset Surfaces

The offset surface tool is useful way of creating a series of deposit or erosion contact surfaces from a reference mesh. The surface can be offset from the reference mesh by points or by a

fixed distance, and additional options for offsetting to points can be adjusted once the surface has been created.

Here a deposit contact surface (blue) has been created using the reference mesh (green) offset to points (red):

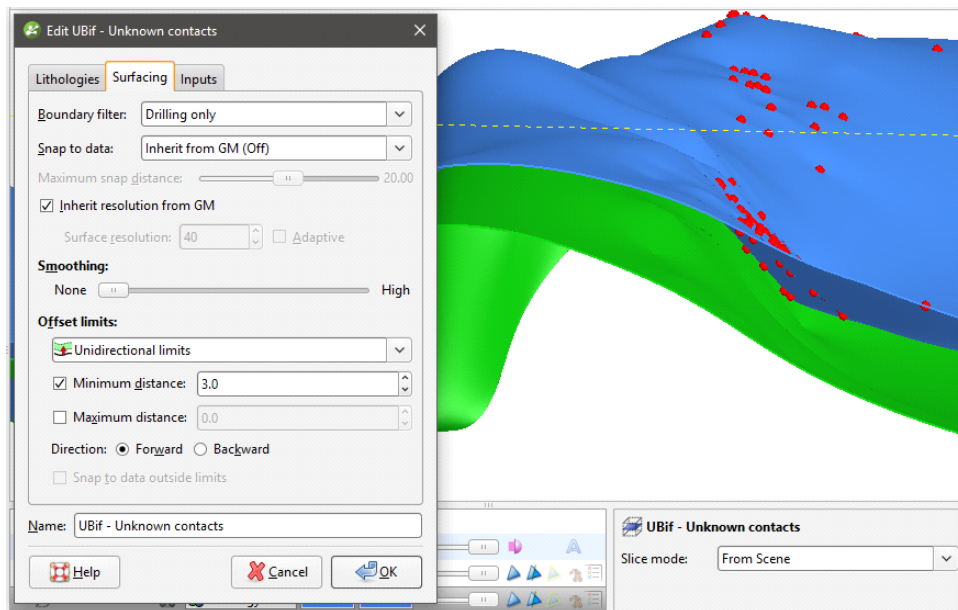

Important considerations when creating offset surfaces is the characteristics of the reference mesh, especially in relation to the geological model's boundary.

- It is best to use a reference mesh that extends beyond the model's boundary. If the reference mesh is too small, the offset surface may be distorted where the reference mesh does not occur.
- If the reference mesh changes significantly near the model's boundary, offset surfaces may show unexpected changes. Offset surfaces are projected in the direction the reference mesh is going, and if the reference mesh changes direction just inside the boundary, that change will be reflected in the offset surface. This is normal if there is data that takes the reference mesh in a different direction, but if this is not desirable for the offset surface, consider making the geological model's boundary smaller.

The rest of this topic describes creating and working with an offset surface. It is divided into:

- [Creating an Offset Surface](#)
- [The Offset Surface in the Project Tree](#)
- [Refining an Offset Surface](#)
- [Changing Surfacing Options for an Offset Surface](#)
- [Changing Offset Limits](#)
- [Changing the Reference Mesh](#)
- [Editing the Reference Mesh](#)

Creating an Offset Surface

To start creating an offset surface, right-click on the **Surface Chronology** and select **New Deposit/Erosion > From Offset Surface**. The **New Offset Surface** window will appear:

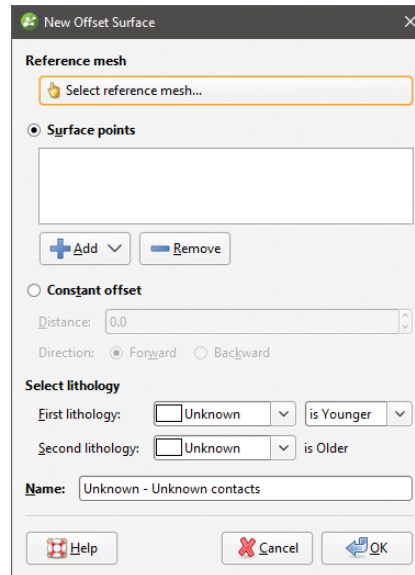

In the window that appears, you need to select a reference mesh, then either select **Surface points** to offset to or set a **Constant offset**.

Click **Select reference mesh** to view the meshes available in the project.

If you wish to offset from the reference mesh using a fixed distance, click **Constant offset** and set the **Distance**. For **Direction**, selecting **Forward** offsets the surface on the younger side of the reference mesh, and selecting **Backward** offsets on the older side.

If you wish to offset to points, click **Add**. You can offset to:

- Base lithology contacts or other lithology contacts in the project.
- Other data in the project. GIS data, points data and polylines can be used.

If you offset to points, you will be able to set additional options such as distance limits once the surface has been created. See [Changing Offset Limits](#) below for more information.

Select the **First Lithology** and **Second Lithology** from the lithologies defined for the model. If you have added base lithology contacts or other contacts to the surface, these will be set automatically from the data used.

Click **OK** to create the surface, which will appear in the project tree as part of the **Surface Chronology**.

The Offset Surface in the Project Tree

The name Leapfrog Geo automatically assigns to an offset surface is the lithologies assigned to each side of the surface. In the project tree, expand the surface to see how it was made:

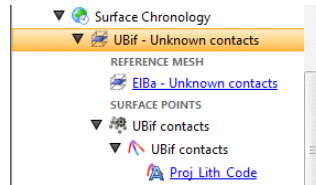

Double-click on the surface to edit it. Double-click on the contact points object (🌐) to edit the lithology and change compositing parameters.

As further refinements are made to the surface, that information will also be added to the project tree. See [Refining an Offset Surface](#) below for more information.

Refining an Offset Surface

You can refine an offset surface by:

- Adding other data. Right-click on the surface to see the options available, which will depend on how the surface was created. See [Adding Data to Surfaces](#) for more information.
- Editing the surface with a polyline. Right-click on the surface in the project tree and select either **Edit**. See [Editing Surfaces with Polylines](#) for more information.

It is not possible to add structural data or polylines with orientation information to an offset surface. If you edit an offset surface with a polyline, your options for editing the polyline will be limited.

To edit the surface's settings, double-click on it in the project tree. In the **Lithologies** tab, change the lithologies assigned to each side of the surface, if required.

You can swap the younging direction if the direction was assigned incorrectly when the surface was created. The change will be reflected in the scene. Note that changing the younging direction does not change which lithology is older or younger.

An offset surface can be created as a deposit or as an erosion. The difference between deposit and erosion contact surfaces is how they cut older lithologies, as described in [Contact Surfaces](#). For this reason, it is possible to change between the two types using the **Contact Type** setting.

An offset surface cannot be adjusted by applying a trend.

Changing Surfacing Options for an Offset Surface

Surfacing options for an offset surface can be changed by double-clicking on the surface in the project tree and then clicking on the **Surfacing** tab. There are additional settings related to boundary filtering and snapping to data in the **Inputs** tab.

Boundary Filtering

When data objects are added to a surface, there are two ways to handle the data that lies outside the surface's boundary:

- Filter the data. The surface is only influenced by the data that falls inside the surface's boundary.
- Leave the data unfiltered. The surface is influenced by the data both inside and outside the surface's boundary.

The **Boundary filter** setting determines how data used to define the surface is filtered:

- **Off**. Data is not filtered.
- **All data**. All data is filtered.
- **Drilling only**. Only drillhole data and data objects derived from drillhole data are filtered.
- **Custom**. Only the data objects specified in the **Inputs** tab are filtered.

Snapping to Data

Often, surfaces should honour drillhole data and treat data objects such as polylines and GIS data as interpretations, as discussed in [Honouring Surface Contacts](#).

There is a **Snap to data** setting for a geological model as a whole that is set in the **Geological Model > General** tab (see [Editing a Geological Model](#)). **Snap to data** can also be set on a surface-by-surface basis by double-clicking on the surface in the project tree and then clicking on the **Surfacing** tab.

For individual contact surfaces, the options are:

- **Inherit from GM**. The setting for the geological model as a whole is used. This is the default setting.
- **Off**. Surfaces do not snap to the data used to create them.
- **All data**. Surfaces snap to all data within the **Maximum snap distance**, which includes drillhole data and any data added to the surfaces.
- **Drilling only**. Surfaces snap to drillhole data and data objects derived from drillhole data within the **Maximum snap distance** but not to other data used to modify the surfaces.
- **Custom**. Surfaces snap to the data objects indicated in the **Inputs** tab for each surface.

Take care in enabling snapping and in selecting what data the surface will snap to, as the more data you include, e.g. by setting a large **Maximum snap distance** or selecting **All data** for **Snap to data**, the greater the possibility that errors in the data or assumptions inherent in interpretations (e.g. polylines) will cause distortions in the meshes. If you do enable snapping, it is best to snap only to drilling data. See [Honouring Surface Contacts](#) for more information on these settings.

If you need a surface to honour drillhole data but treat other data objects as interpretations, select **Drilling only**. To honour some data objects while treating others as interpretations, select **Custom**, then click on the **Inputs** tab to enable snapping for individual objects.

There is also a snap setting that can be used when offset limits are used. This option is discussed in [Changing Offset Limits](#) below.

Surface Resolution

The surface resolution for an offset surface can be inherited from the geological model or it can be set specifically for the surface. To change the surface resolution for an offset surface, double-click on the surface in the project tree and then click on the **Surfacing** tab. See [Surface Resolution for a Geological Model](#) for information about the surface resolution settings in the **Surfacing** tab.

Smoothing

The **Smoothing** parameter in the **Surfacing** tab can be used for all offset types other than **Constant**. If your reference surface is highly curved, you may see distortions in the offset surface. If this is the case, set **Smoothing** to a higher value.

Increasing the **Smoothing** parameter will generally result in faster processing when offsetting to large distances. If you are finding that processing time is excessively long for an offset surface, consider increasing **Smoothing**. In some situations, however, increasing **Smoothing** can exaggerate imperfections in the reference surface.

If you are offsetting by a small distance and processing is taking longer than expected, consider setting **Smoothing** to **None**.

Changing Offset Limits

There are four options for **Offset limits** in the **Surfacing** tab. Three relate to offsetting to points and the fourth to offsetting to a fixed distance from the reference mesh.

- The **None** option is the default setting used when a surface is created as an offset to points. No distance limits are used in creating the offset surface, and it simply follows the points used.
- The **Unidirectional limits** option allows you to set distance limits in one direction. Points outside the limits will be disregarded.
- The **Bidirectional limits** option allows you to set distance limits in both directions, and points outside these limits are disregarded. This setting is useful for modelling folded surfaces such as veins.
- The **Constant offset** option offsets the surface to a fixed distance from the reference mesh.

The **Forward** direction is the younger side of the reference mesh.

If the **Snap to data outside limits** setting is enabled, the surface will honour data, even if it is outside the distance limits. This option will be greyed out if **Snap to data** is off.

Changing to a Constant Offset

To use a constant offset rather than points, select the **Constant offset** option and set the **Distance** and **Direction** to offset the surface. Selecting **Forward** offsets the surface on the younger side of the reference mesh, whereas selecting **Backward** offsets on the older side.

If you created a surface as an offset to points and switch to using a constant offset, the points added to the surface when it was created will be disabled.

Changing to an Offset to Points

If you created an offset surface using a constant offset, you can change the surface to offset to points, but you must first add data to it. Do this by right-clicking on it in the project tree and selecting **Add**. Once you have added the data you wish to use, double-click on the surface and click on the **Surfacing** tab. Change the **Offset limits** option from **Constant offset** to one of the other three options.

Changing the Reference Mesh

To change the surface used as the reference mesh, click on the **Inputs** tab, then click on the reference mesh:

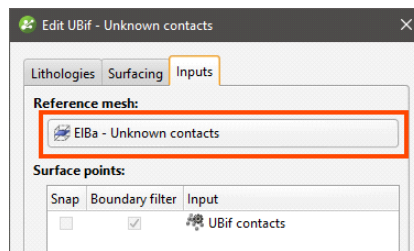

Select from the surfaces available in the project, keeping in mind the considerations discussed in [Changing the Reference Mesh](#).

Editing the Reference Mesh

You can also edit the reference mesh as you would other surfaces. All dependent offset surfaces will be updated as you make changes to the reference mesh.

Changing the younging direction of the reference mesh affects how offset surfaces are generated.

- For a constant offset surface, the younging direction of the reference mesh determines the forward and backward direction of the offset surface and, therefore, determines the location of the offset surface. Changing the younging direction of the reference mesh results in dependent offset surfaces changing location; the updated offset surface will be the mirror image of the original relative to the reference mesh.
- For surfaces offset to points, the location is determined by the points themselves. If the reference mesh's younging direction is changed, the offset surface's younging direction will also be flipped. The offset surface will still honour the contact data and will still appear at the same location relative to the reference mesh.

Structural Surfaces

A structural surface uses contact data and non-contact structural data to create a surface. A structural surface can interact with other volumes in the model as a deposit, an erosion or an intrusion contact surface. The shape of the structural surface is suggested by the non-contact structural data used.

When creating a structural surface, there are two options for declustering the non-contact structural data:

- The input data is automatically declustered as part of creating the structural surface. There are no additional controls that determine how the data is declustered.
- Use a declustered structural data set as the non-contact input to the surface. This approach is recommended over the first approach as you can change how the data is declustered.

The rest of this topic describes how to create and work with a structural surface. It is divided into:

- [Creating a Structural Surface](#)
- [The Structural Surface in the Project Tree](#)
- [Refining a Structural Surface](#)
- [Surfacing Options for a Structural Surface](#)
- [Non-Contact Structural Inputs Settings](#)
- [Applying a Trend to a Structural Surface](#)
- [Value Clipping](#)

Creating a Structural Surface

To create a new structural surface, right-click on the **Surface Chronology** and select **New Structural Surface**. The **New Structural Surface** window will appear:

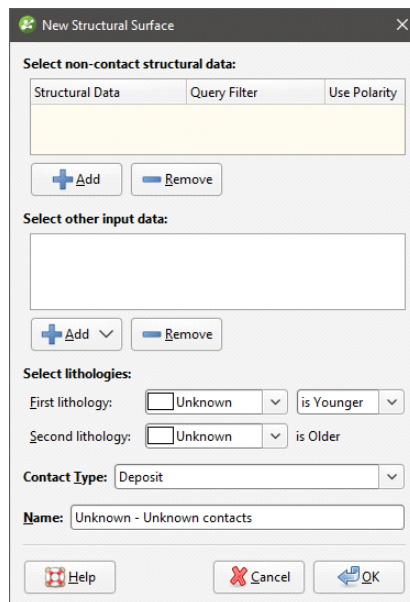

Use the **Add** buttons to add non-contact structural data and on-surface contacts, then set the **First lithology** and **Second lithology**. Other settings are:

- **Query Filter**. Select from the query filters defined for the selected structural data object.
- **Use Polarity**. Untick the box to use tangents only.

- **Contact Type.** Structural surfaces can be deposit, erosion or intrusion contacts. The same algorithm is used for each setting; the only difference is in how the surface interacts with other surfaces.

The Structural Surface in the Project Tree

The name Leapfrog Geo automatically assigns to a structural surface is the lithologies assigned to each side of the surface. In the project tree, expand the surface to see how it was made:

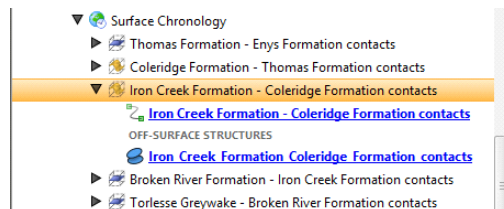

As further refinements are made to the surface, that information will also be added to the project tree. See [Refining a Structural Surface](#) below for more information.

To add more non-contact structural data to the surface, right-click on it in the project tree and select **Add > Structural Data**. In the window that appears, tick the box for **Non-contact Structural Data**:

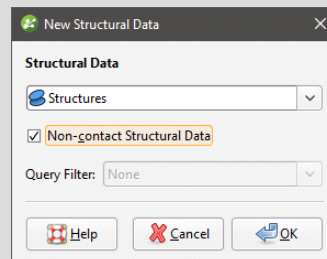

Refining a Structural Surface

You can refine structural surfaces in several ways:

- Add other data. Right-click on the surface to see the options available, which will depend on how the surface was created. See [Adding Data to Surfaces](#) for more information.
- Edit the surface with a polyline. Right-click on the surface in the project tree and select either **Edit > With Polyline**. See [Editing Surfaces with Polylines](#) for more information.
- Edit the surface using structural data. Right-click on the surface and select **Edit > With Structural Data**. See [Editing Surfaces with Structural Data](#) for more information.

To edit the surface's settings, double-click on it in the project tree. In the **Lithologies** tab, change the lithologies assigned to each side of the surface, if required.

You can swap the younging direction if the direction was assigned incorrectly when the surface was created. The change will be reflected in the scene. Note that changing the younging direction does not change which lithology is older or younger.

The **Contact Type** setting determines how the structural surface interacts with other lithologies, as described in [Contact Surfaces](#). A structural surface can be a deposit, erosion or intrusion contact surface.

For information on other techniques for refining structural surfaces, see [Surfacing Options for a Structural Surface](#) below.

Surfacing Options for a Structural Surface

Surfacing options for a structural surface are accessed by double-clicking on the surface in the project tree and clicking on the **Surfacing** tab. There are additional settings related to boundary filtering and snapping to data in the **Inputs** tab.

Setting the Surface Resolution

See [Surface Resolution for a Geological Model](#) for information about the surface resolution settings in the **Surfacing** tab.

Boundary Filtering

When data objects are added to a surface, there are two ways to handle the data that lies outside the surface's boundary:

- Filter the data. The surface is only influenced by the data that falls inside the surface's boundary.
- Leave the data unfiltered. The surface is influenced by the data both inside and outside the surface's boundary.

The boundary of a structural surface can be the geological model boundary or a fault block boundary.

The **Boundary filter** setting determines how data used to define the surface is filtered:

- **Off**. Data is not filtered.
- **All data**. All data is filtered.
- **Drilling only**. Only drillhole data and data objects derived from drillhole data are filtered.
- **Custom**. Only the data objects specified in the **Inputs** tab are filtered.

Snapping to Input Data

Often, surfaces should honour drillhole data and treat data objects such as polylines and GIS data as interpretations. See [Honouring Surface Contacts](#).

There is a **Snap to data** setting for a geological model as a whole that is set in the **Geological Model > General** tab (see [Editing a Geological Model](#)). **Snap to data** can also be set on a surface-by-surface basis by double-clicking on the surface in the project tree and then clicking on the **Surfacing** tab.

For individual contact surfaces, the options are:

- **Inherit from GM**. The setting for the geological model as a whole is used. This is the default setting.

- **Off.** Surfaces do not snap to the data used to create them.
- **All data.** Surfaces snap to all data within the **Maximum snap distance**, which includes drillhole data and any data added to the surfaces.
- **Drilling only.** Surfaces snap to drillhole data and data objects derived from drillhole data within the **Maximum snap distance** but not to other data used to modify the surfaces.
- **Custom.** Surfaces snap to the data objects indicated in the **Inputs** tab for each surface.

Take care in enabling snapping and in selecting what data the surface will snap to, as the more data you include, e.g. by setting a large **Maximum snap distance** or selecting **All data** for **Snap to data**, the greater the possibility that errors in the data or assumptions inherent in interpretations (e.g. polylines) will cause distortions in the meshes. If you do enable snapping, it is best to snap only to drilling data. See [Honouring Surface Contacts](#) for more information on these settings.

If you need a surface to honour drillhole data but treat other data objects as interpretations, select **Drilling only**. To honour some data objects while treating others as interpretations, select **Custom**, then click on the **Inputs** tab to enable snapping for individual objects.

Non-Contact Structural Inputs Settings

For the non-contact structural inputs, you can:

- Change the **Query Filter** setting. Select from the query filters defined for the selected structural data object.
- Change the **Use Polarity** setting. Untick the box to use tangents only.
- Change the **Boundary filter** setting, if the **Boundary filter** setting in the **Surfacing** tab is set to **Custom**.

Applying a Trend to a Structural Surface

There are two ways to change the trend for a structural surface:

- Right-click on the surface in the project tree and select **Adjust Surface**.
- Double-click on the surface in the project tree and then click on the **Trend** tab.

See [Global Trends](#) for more information.

Value Clipping

In the **Value Clipping** tab, you can manipulate the data distribution by clipping the data. Clipping caps values that are outside the range set by the **Lower bound** and **Upper bound** values. For example, if you change the **Upper bound** from 16.00 to 10.00, distance values above 10.00 will be regarded as 10.00.

When **Automatic clipping** and **Do clipping** are enabled, Leapfrog Geo sets the **Lower bound** and **Upper bound** from the data. To change the **Lower bound** and **Upper bound**, untick **Automatic clipping**, tick **Do clipping** and then change the values.

The Surface Chronology

When you create a contact surface, it appears in the project tree under the **Surface Chronology** object, but it is not enabled and, therefore, does not affect the geological model volumes. This means you can work on the surface without having to reprocess the model whenever you make a change to the surface. In Leapfrog Geo, you can easily define, enable and remove contact surfaces from a model, and you can experiment with modelling lithologies using different techniques in order to arrive at a geologically reasonable model.

To add a contact surface to the surface chronology, double-click on the **Surface Chronology** object. The **Surface Chronology** window will be displayed:

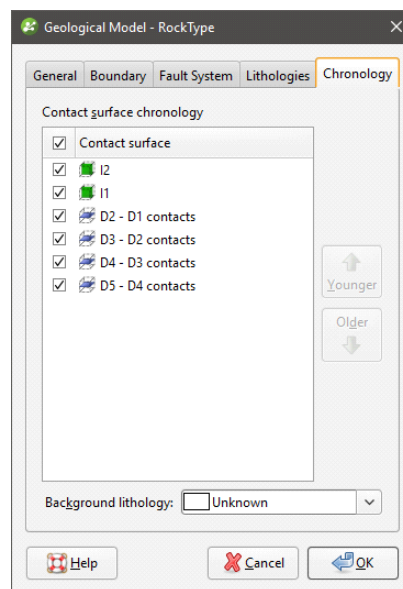

In the project tree, the surfaces are also arranged in chronological order:

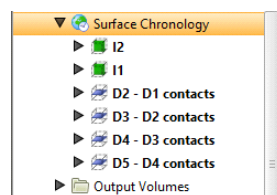

The **Surface Chronology** determines the overall chronological order of the contact surfaces in the model. If you build your models from the bottom up, you will find that often the contact surfaces are in the correct chronological order when you first open the **Surface Chronology** window. However, you can easily rearrange the chronology using the **Younger** and **Older** buttons. Tick the boxes for surfaces you wish to include in the model. When you click **OK**, the included surfaces will be used to subdivide the geological model into lithological volumes. The volumes will appear in the **Output Volumes** folder.

Output volumes are named according to the lithologies assigned to each side of the contact surfaces that bound each volume. If the lithology assigned to an output volume cannot be determined, it will be assigned the **Background lithology**.

If you are working with a faulted model and have defined the **Surface Chronology** for one fault block, you can copy the **Surface Chronology** to the empty fault blocks. See [Copying the Surface Chronology to an Empty Fault Block](#).

Refined Models

When you have built a geological model and want to model further within one of the volumes, you can do this by creating a refined geological model. This changes the way the original (parent) geological model is organised in the project tree and makes it possible to create a sub-model within one or more of the lithological volumes.

Before starting to refine lithological volumes, it is a good idea to make a copy of the original geological model.

To start refining a lithological volume, first create the refined geological model. To do this, right-click on the **Geological Models** folder and select **New Refined Model**:

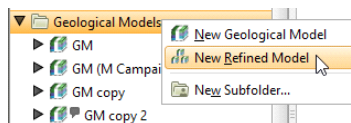

In the window that appears, select the geological model to refine and then select from its lithologies.

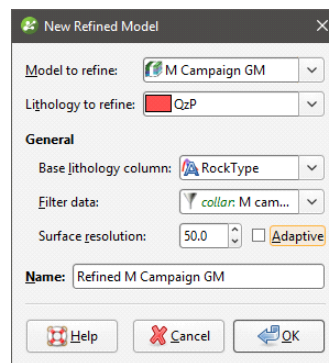

Next, set the **Base lithology column**, **Filter data** and **Surface resolution**. You cannot change the **Base lithology column** once the refined geological model has been established, but you will be able to change the resolution and data filter settings.

Click **OK** to create the refined lithology.

A new refined model (🏗️) will be created in the project tree and the parent geological model will be moved into it. Here, a model called “M Campaign GM” has been used to create a new refined model, with the QzP volume selected as the refined lithology (🏗️):

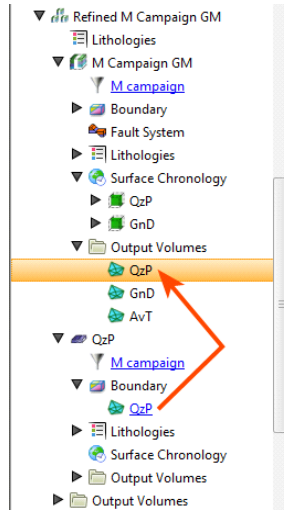

The sub-model (🏗️) is created inside the refined geological model and has its own **Boundary**, **Lithologies**, **Surface Chronology** and **Output Volumes** objects.

You can work with the sub-model in the same manner you would a normal geological model. The exceptions are:

- The sub-model’s boundary cannot be refined directly. However, changes to the parent geological model will be updated in the sub-model’s boundary.
- The sub-model cannot have its own fault system. If the parent geological model is faulted, the sub-model will have its own fault blocks in which you can work.

See [Editing the Sub-Model](#) for information on refining the sub-model.

You can still work with the parent geological model in the usual manner. Any changes to the parent geological model that change the extents of the sub-model will be reflected in the sub-model’s boundary.

You can create additional sub-models by right-clicking on the refined model (🏗️) and selecting **Refine Lithology**.

A sub-model can be viewed and evaluated in the same manner as normal geological models. However, sub-models cannot be used as layer guides for flow models.

Deleting the refined geological model deletes all models it contains. To return to the original project tree organisation for a geological model, delete the sub-models:

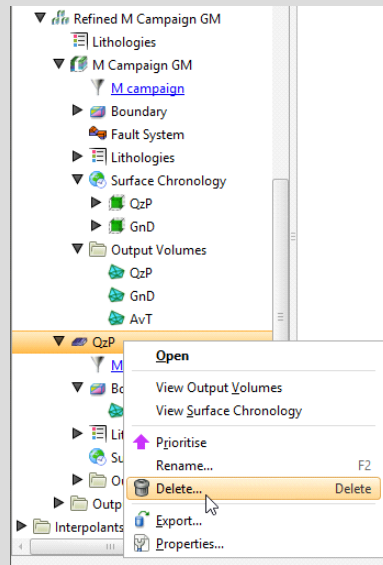

Once there are no more sub-models, the refined model object is also deleted, leaving the parent geological model.

The refined model has its own **Lithologies** table, which contains all the lithologies from the parent model and any sub-model lithologies. You cannot add lithologies to this table, but you can change the colours used to display them in the scene, as described in [Model Lithologies](#). To add more lithologies to a refined model, add them to the lithology table in either the sub-model or the parent geological model.

The refined model also has its own **Output Volumes** folder that combines information from the parent geological model and the sub-model. If no surfaces have been created in the sub-model, adding the refined model to the scene will simply display the volumes from the parent geological model. If surfaces have been created in the sub-model, then the volumes of the sub-model will be displayed alongside the volumes from the parent geological model.

Editing the Sub-Model

Work with the sub-model in the same manner described in [Editing a Geological Model](#). See [Contact Surfaces](#) and [The Surface Chronology](#).

The sub-model can have resolution settings that are different from those of the parent model. See [Surface Resolution in Leapfrog Geo](#) and [Surface Resolution for a Geological Model](#).

To change the lithology's resolution settings, double-click on the sub-model (📁) in the project tree. The **Geological Model** window appears:

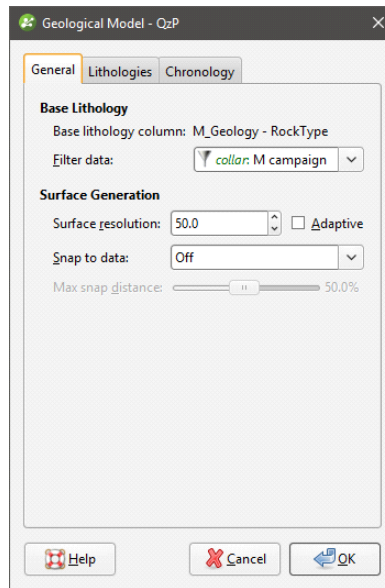

This window has only three tabs:

- There is no **Boundary** tab because the sub-model's boundary can only be modified by modifying the parent geological model.
- There is no **Fault System** tab because a sub-model cannot have its own fault system.

Numeric Models

The FastRBF algorithm employs interpolation functions to estimate values from known data. From these estimated values, geological surfaces are constructed as part of the model-building process.

With the **Numeric Models** folder, you can create numeric models and change their parameters.

- An RBF interpolant describes a physical quantity that varies continuously in space. An RBF interpolant can be used to model, for example, grade distribution, with isosurface values set to represent both minimum concentrations of interest and regions of high value. See [RBF Interpolants](#).
- A multi-domained RBF interpolant is an RBF interpolant that has a number of individual sub-interpolants that are bounded by the fault blocks or output volumes of a selected geological model. Changes to all sub-interpolants can be made by editing the parent interpolant, while sub-interpolants can be edited to account for local influences on the values used, the trend and interpolation parameters. See [Multi-Domained RBF Interpolants](#).
- An indicator RBF interpolant calculates the likelihood that values will fall above and below a specific threshold. An indicator RBF interpolant can be used to produce a volume inside which further modelling is carried out. For example, you can create an indicator RBF interpolant for grade values above a certain threshold, and then use the inside volume as a lateral extent for another model. See [Indicator RBF Interpolants](#).
- A distance function calculates the distance to a set of points. As with an indicator RBF interpolant, a distance function is useful for restricting processing to a specific region. To do this, create a distance function, select the objects to use, then add at least one buffer. You can then use one of the distance function's isosurfaces as a lateral extent for another model. See [Distance Functions](#).

Values that can be interpolated include downhole numeric data, composited drillhole data and points data. See [Interpolant Functions](#) for a general introduction to interpolation.

The rest of this topic describes:

- [Importing a Variogram Model](#)
- [Copying a Numeric Model](#)
- [Creating a Static Copy of a Numeric Model](#)
- [Exporting Numeric Model Volumes and Surfaces](#)
- [Exporting Numeric Model Midpoints](#)

Importing a Variogram Model

Leapfrog Geo can import spheroidal variogram models exported from Snowden Supervisor. The settings that can be imported are:

- The anisotropy settings in the **Trend** tab
- The **Nugget**, **Total Sill**, **Base Range** and **Alpha** settings in the **Interpolant** tab

To import a variogram model, first create an interpolant. Next, right-click on the interpolant and select **Import Variogram Parameters**. In the window that appears, navigate to the folder that contains the XML file and select it. Click **Open**. The interpolant will be updated with the parameters in the XML file.

The imported variogram model overwrites the parameters in the interpolant, which cannot be undone. If you wish to save the original settings, make a copy of the interpolant before importing the new parameters.

Once the interpolant has been updated, you can edit it further by double-clicking on the interpolant in the project tree.

Copying a Numeric Model

Creating a copy of a numeric model is a useful way of experimenting with changes to a model. To copy a numeric model, right-click on it in the project tree and select **Copy**. Enter a name for the copy of the model and click **OK**. The copy will be added to the project tree.

Creating a Static Copy of a Numeric Model

Creating a static copy preserves a snapshot of a numeric model that does not change, even when changes are made to the data on which the original model was dependent. This is a useful way of storing historical models and comparing models. Static copies can be exported from Leapfrog Geo, as described in [Exporting Numeric Model Volumes and Surfaces](#) below.

To create a static copy of a numeric model, right-click on it in the project tree and select **Static Copy**. Enter a name for the copy of the numeric model and click **OK**. The copy will be added to the **Numeric Models** folder.

The objects that make up a static copy of a numeric model depend on the type of model:

- For an RBF interpolant, a static copy is made up of a **Legend** object, a **Boundary** object, and all isosurfaces and output volumes created in building the model.
- For a multi-domained RBF interpolant, a static copy is made up of a **Legend** object, a **Boundary** object, and the output volumes created in building the model. There are also static copies of the sub-interpolants, which are the same as static copies of RBF interpolants.
- For an indicator RBF interpolant, a static copy is made up of a **Legend** object, a **Boundary** object, the model's isosurface and the output volumes.

Static models created in versions of Leapfrog Geo before 2.2 copied only the output volumes and the legend, and the static model appeared in the shape list only as a single line. When these static models are upgraded and displayed in the scene, the individual output volumes will be added to the shape list.

To view the date a static copy was created, right-click on it in the project tree and select **Properties**. The date the copy was created is in the **General** tab.

Exporting Numeric Model Volumes and Surfaces

There are three options for exporting a numeric model's output volumes and surfaces. These are:

- Export an output volume or a surface as a mesh. Right-click on it in the project tree and click **Export**. You will be prompted for a file name and location. See [Exporting a Single Mesh](#).
- Export an output volume as a thickness grid. Right-click on it in the project tree and click **Export Thickness Grid**. See [Thickness Grids](#).
- Export multiple output volumes and surfaces. Right-click on the interpolant in the project tree and select **Export**. See [Exporting Multiple Meshes from Models](#).

Exporting Numeric Model Midpoints

To export interval midpoints from a numeric model, right-click on the model's values object (📁) and select **Export**. Interval midpoints can be exported in the following formats:

- CSV text file (*.csv)
- DXF file (*.dxf)
- Snowden Supervisor CSV file (*.csv)
- Isatis 3D points file (*.asc)
- Drawing Files (2013/LT2013) (*.dwg)

The values exported are the midpoints of each segment, the X-Y-Z values and the hole ID. The Snowden Supervisor and Isatis 3D points formats also include the interval length, when the model has been created from drillhole data.

In each case, you will be prompted for a filename and location.

You can extract interval midpoints from drillhole data and then export them from the **Points** folder. See [Extracting Interval Midpoints from Drillhole Data](#) for more information.

RBF Interpolants

If the data is both regularly and adequately sampled, different RBF interpolants will produce similar results. In practice, however, it is rarely the case that data is so abundant and input is

required to ensure an interpolant produces geologically reasonable results. For this reason, only a basic set of parameters are required when an RBF interpolant is first created. Once the interpolant has been created, you can refine it to factor in real-world observations and account for limitations in the data.

The rest of this topic describes how to create and modify RBF interpolants. It is divided into:

- [Creating an RBF Interpolant](#)
- [The RBF Interpolant in the Project Tree](#)
- [Interpolant Display](#)
- [RBF Interpolant Statistics](#)
- [Modifying an RBF Interpolant's Boundary with Lateral Extents](#)
- [Changing the Settings for an RBF Interpolant](#)

Creating an RBF Interpolant

To create an RBF interpolant, right-click on the **Numeric Models** folder and select **New RBF Interpolant**. The **New RBF Interpolant** window will be displayed:

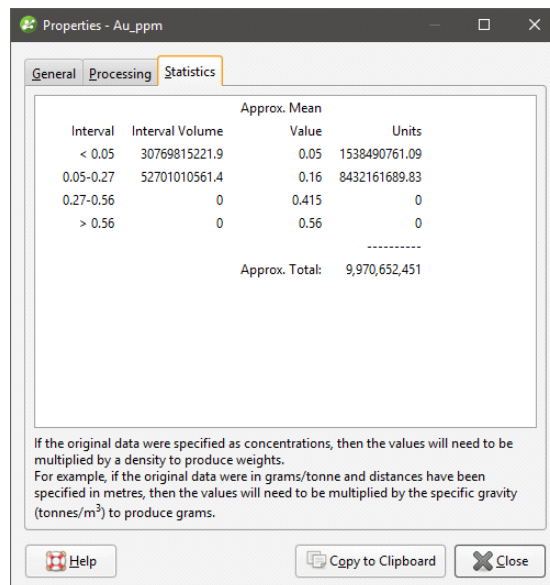

This window is divided into four parts that determine the values used to create the interpolant, the interpolant boundary, any compositing options and general interpolant properties.

If you are unsure of some settings, most can be changed later. However, the **Numeric values** object selected when the interpolant is created cannot be changed.

Values Used

In the **Values To Interpolate** part of the **New RBF Interpolant** window, you can select the values that will be used and choose whether or not to filter the data and use a subset of those values in the interpolant.

You can build an interpolant from either:

- Numeric data contained in imported drillhole data.
- Points data imported into the **Points** folder.

All suitable data in the project is available from the **Numeric values** list.

Applying a Query Filter

If you have defined a query filter and wish to use it to create the interpolant, select the filter from the **Query filter** list. Once the interpolant has been created, you can remove the filter or select a different filter.

Applying a Surface Filter

All available data can be used to generate the interpolant or the data can be filtered so that only the data that is within the interpolant boundary or another boundary in the project influences the interpolant. The **Surface Filter** option is enabled by default, but if you wish to use all data in the project, untick the box for **Surface Filter**. Otherwise, you can select the **Interpolant Boundary** or another boundary in the project.

You can use both the **Query Filter** option and the **Surface Filter** option together.

The Interpolant Boundary

There are several ways to set the **Interpolant Boundary**:

- Enter values to set a **Custom** boundary.
- Use the controls in the scene to set the **Custom** boundary dimensions.
- Select another object in the project from the **Enclose Object** list, which could be the numeric values object being interpolated. The extents for that object will be used as the basis for the **Custom** boundary dimensions.
- Select another object in the project to use as the **Interpolant Boundary**. Click the **Existing model boundary or volume** option and select the required object from the list.

Once the interpolant has been created, you can further modify its boundary. See [Modifying an RBF Interpolant's Boundary with Lateral Extents](#) and [Adjusting the Interpolant Boundary](#) below.

Compositing Options

When numeric values from drillhole data are used to create an interpolant, there are two approaches to compositing that data:

- Composite the drillhole data, then use the composited values to create an interpolant. If you select composited values to create an interpolant, compositing options will be disabled.
- Use drillhole data that hasn't been composited to create an interpolant, then apply compositing settings to the interpolated values. If you are interpolating values that have not been composited and do not have specific **Compositing** values in mind, you may wish to leave this option blank as it can be changed once the model has been created.

If you are interpolating points, compositing options will be disabled.

See [Numeric Composites](#) for more information on the effects of the **Compositing length**, **For end lengths less than** and **Minimum coverage** settings.

General Interpolant Properties

Set the **Surface resolution** for the interpolant and whether or not the resolution is adaptive. See [Surface Resolution in Leapfrog Geo](#) for more information on the effects of these settings. The resolution can be changed once the interpolant has been created, so setting a value in the **New RBF Interpolant** window is not vital. A lower value will produce more detail, but calculations will take longer.

The **Volumes enclose** option determines whether the interpolant volumes enclose **Higher Values**, **Lower Values** or **Intervals**. Again, this option can be changed once the interpolant has been created.

Enter a **Name** for the new interpolant and click **OK**.

Once you have created an RBF interpolant, you can adjust its properties by double-clicking on it. You can also double-click on the individual objects that make up the interpolant.

See also:

- [Copying a Numeric Model](#)
- [Creating a Static Copy of a Numeric Model](#)
- [Exporting Numeric Model Volumes and Surfaces](#)

The RBF Interpolant in the Project Tree

The new interpolant will be created and added to the **Numeric Models** folder. The new interpolant contains objects that represent different parts of the interpolant:

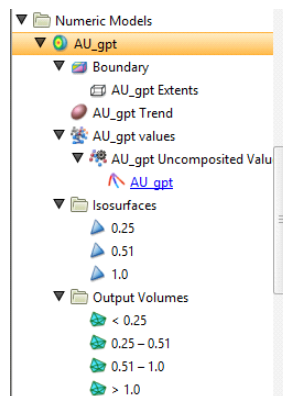

- The **Boundary** object defines the limits of the interpolant. See [Adjusting the Interpolant Boundary](#).
- The **Trend** object describes the trend applied in the interpolant. See [Changing the Trend for an RBF Interpolant](#).
- The points data values object contains all the data used in generating the interpolant. See [Adjusting the Values Used](#).

- The **Isosurfaces** folder contains all the meshes generated in building the interpolant.
- The **Output Volumes** folder contains all the volumes generated in building the interpolant.

Other objects may appear in the project tree under the interpolant as you make changes to it.

Interpolant Display

Display the interpolant by:

- Dragging the interpolant into the scene or right-clicking on the interpolant and selecting **View Output Volumes**. Both actions display the interpolant's output volumes.
- Right-clicking on the interpolant and selecting **View Isosurfaces**.

RBF Interpolant Statistics

You can view the approximated mean for each output volume by right-clicking on the interpolant and selecting **Properties**. Click on the **Statistics** tab:

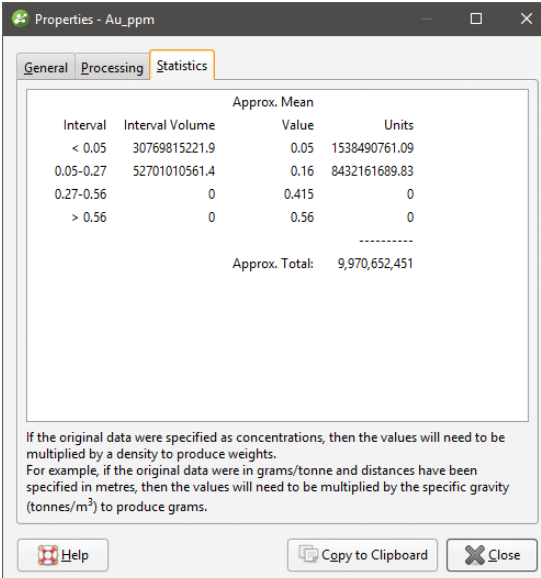

Approx. Mean			
Interval	Interval Volume	Value	Units
< 0.05	30769815221.9	0.05	1538490761.09
0.05-0.27	52701010561.4	0.16	8432161689.83
0.27-0.56	0	0.415	0
> 0.56	0	0.56	0
Approx. Total:			9,970,652,451

If the original data were specified as concentrations, then the values will need to be multiplied by a density to produce weights.
For example, if the original data were in grams/tonne and distances have been specified in metres, then the values will need to be multiplied by the specific gravity (tonnes/m³) to produce grams.

You can copy the information displayed in the **Statistics** tab to the clipboard for use in other applications.

Modifying an RBF Interpolant's Boundary with Lateral Extents

RBF interpolants are created with a basic set of rectangular extents that can then be refined using other data in the project. These extents usually correspond to the ground surface and known boundaries. Creating extents can also be used to restrict modelling to a particular area of interest; for example, modelling can be restricted to a known distance from drillholes by applying a distance function as a lateral extent. Extents do not need to be strictly vertical surfaces and can be model volumes.

Creating Lateral Extents

To create an extent, expand the RBF interpolant in the project tree. Right-click on the **Boundary** object and select from the **New Lateral Extent** options. Follow the prompts to create the extent, which will then appear in the project tree under the interpolant's **Boundary** object.

New extents are automatically applied to the boundary being modified. Leapfrog Geo usually orients a new extent correctly, with red presenting the inside face of the extent and blue representing the outside face. If this is not the case, you can change the orientation by right-clicking on the extent in the project tree and selecting **Swap Inside**.

Extent from a Polyline

You can create an extent from a polyline that already exists in the project or you can draw a new one. If you want to use an imported polyline, import it into the **Polylines** folder before creating the new extent.

To create a new extent from a polyline, right-click on the interpolant's **Boundary** object and select **New Lateral Extent > From Polyline**. In the window that appears, select whether you will create a new polyline or use an existing one:

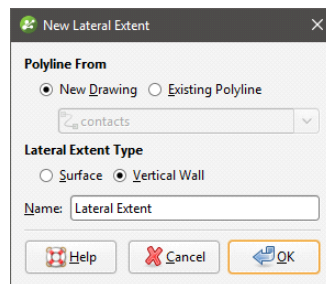

You can create the extent as a **Vertical Wall** or **Surface**. If you create the lateral extent as a **Surface**, you will be able to modify it using additional data, as described below. A lateral extent created as a **Vertical Wall**, however, cannot be modified.

Click **OK** to generate the new extent. If you have chosen to create a **New Drawing**, the drawing controls will appear in the scene and you can begin drawing, as described in [Drawing in the Scene](#).

The new extent will appear in the project tree as part of the **Boundary** object.

If the surface generated does not fit the polyline adequately, you can increase the quality of the fit by adding more points to the polyline. See [Drawing in the Scene](#) for information on adding points to polylines.

Extents created from polylines can be modified by adding points data, GIS vector data and structural data. You can also add polylines and structural data to the extent. See [Adding Data to an Extent](#), [Editing an Extent with a Polyline](#) and [Editing an Extent with Structural Data](#) for more information.

Extent from GIS Vector Data

GIS data in the project can be used to create a lateral extent for an RBF interpolant. Once the data you wish to use has been imported into the project, right-click on the interpolant's **Boundary** object and select **New Lateral Extent > From GIS Vector Data**.

In the window that appears, select the data object you wish to use:

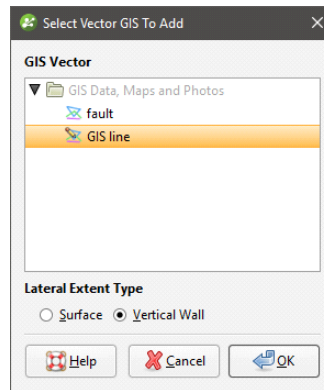

You can create the extent as a **Vertical Wall** or **Surface**. If you create the lateral extent as a **Surface**, you will be able to modify it using additional data, as described below. A lateral extent created as a **Vertical Wall**, however, cannot be modified.

If you select the **Surface** option, you can use the GIS data object with its own elevation data or projected onto the topography:

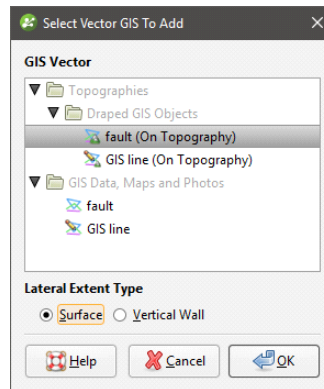

Using the **On Topography** option makes sense for GIS data as it is, by nature, on the topography. The **On Topography** option also mitigates any issues that may occur if elevation information in the GIS data object conflicts with that in the project.

Click **OK** to create the new extent. The new extent will appear in the project tree as part of the **Boundary** object.

Extents created from GIS data can be modified by adding points data, GIS vector data and structural data. You can also add polylines and structural data to the extent. See [Adding Data to an Extent](#), [Editing an Extent with a Polyline](#) and [Editing an Extent with Structural Data](#) for more information.

Extent from Points

To create a new extent from points data, right-click on the interpolant's **Boundary** object and select **New Lateral Extent > From Points**. The **Select Points To Add** window will be displayed, showing points data available in the project:

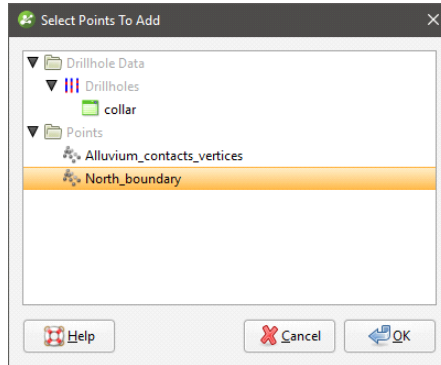

Select the information you wish to use and click **OK**.

The new extent will appear in the project tree as part of the **Boundary** object.

Extents created from points can be modified by adding points data, GIS vector data and structural data. You can also add polylines and structural data to the extent. See [Adding Data to an Extent](#), [Editing an Extent with a Polyline](#) and [Editing an Extent with Structural Data](#) for more information.

Extent from Structural Data

Planar structural data can be used to create a lateral extent for an RBF interpolant. You can create a new structural data table or use a table that already exists in the project. If you want to use categories of structural data in creating the extent, use an existing table and create filters for those categories before creating the lateral extent.

To start, right-click on the interpolant's **Boundary** object and select **New Lateral Extent > From Structural Data**. The **New Structural Data** window will be displayed, showing structural data available in the project:

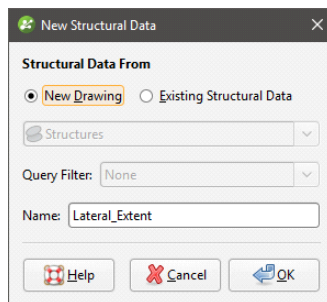

Select the **New Drawing** option to draw the structural data points directly in the scene.

Select the **Existing Structural Data** option to use a table in the **Structural Modelling** folder. With this option, you will be able to select from the categories available in the data table, if query filters have been created for those categories:

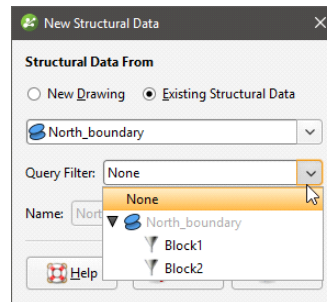

Click **OK** to generate the new extent. If you have chosen to create a **New Drawing**, the drawing controls will appear in the scene and you can begin drawing, as described in [Creating New Planar Structural Data Tables](#). To share the new structural data table, right-click on it and select **Share**. The table will be saved to the **Structural Modelling** folder.

The new extent will appear in the project tree as part of the **Boundary** object.

Extents created from structural data can be modified by adding points data, GIS vector data and structural data. You can also add polylines and structural data to the extent. See [Adding Data to an Extent](#), [Editing an Extent with a Polyline](#) and [Editing an Extent with Structural Data](#) for more information.

Extent from a Surface

To use a surface as lateral extent for an RBF interpolant, right-click on the interpolant's **Boundary** object and select **New Lateral Extent > From Surface**. The **Select Boundary** window will appear, showing all the meshes that can be used as an extent:

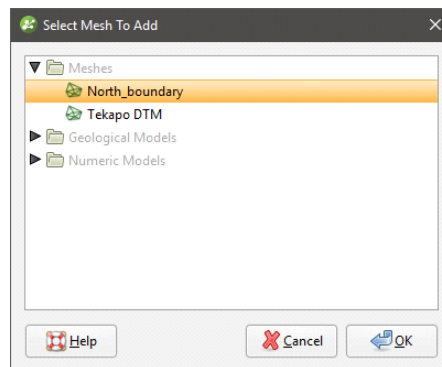

Select the required mesh and click **OK**. The extent will be added to the interpolant's **Boundary** object.

You cannot modify an extent created from a mesh by adding data, editing with polylines or structural data or by applying a trend. However, the extent is linked to the mesh used to create it, and updating the mesh will update the extent.

Extent from Distance to Points

Leapfrog Geo can calculate the distance to set of points and use the resulting distance buffer as a lateral extent for an RBF interpolant. To create a new lateral extent from a distance buffer,

right-click on the interpolant's **Boundary** object and select **New Lateral Extent > From Distance To Points**. The **Smoothed Distance Buffer** window will appear:

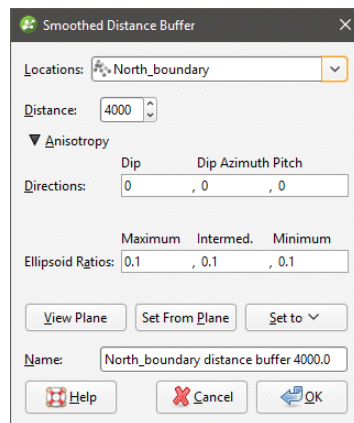

Select the **Distance** and set an **Anisotropy**, if required.

The **Ellipsoid Ratios** determine the relative shape and strength of the ellipsoids in the scene, where:

- The **Maximum** value is the relative strength in the direction of the green line on the moving plane.
- The **Intermed.** value is the relative strength in the direction perpendicular to the green line on the moving plane.
- The **Minimum** value is the relative strength in the direction orthogonal to the plane.

You can also use the **Set to** list to choose different options Leapfrog Geo has generated based on the data used to build the interpolant. **Isotropic** is the default option used when the interpolant is created.

Click **OK** to create the new extent, which will appear in the project tree as part of the **Boundary** object.

To change the extent's settings, expand the interpolant's **Boundary** object in the project tree and double-click on the extent. Adjust the **Distance** and **Anisotropy**, if required.

Extents created from a distance to points function can be modified by adding points data and GIS vector data. See [Adding Data to an Extent](#).

Extent from a Distance Function

A distance function calculates the distance to a set of points and can be used to bound an RBF interpolant. You can use an existing distance function as a lateral extent or create a new one.

To use a distance function as a lateral extent, right-click on the interpolant's **Boundary** and select **New Lateral Extent > From Distance Function**. If there are no distance functions in the project, you will be prompted to create a new one. See [Distance Functions](#) for information on defining and editing the distance function.

When there are already distance functions in the project, you will be prompted to choose between creating a new function or using an existing one:

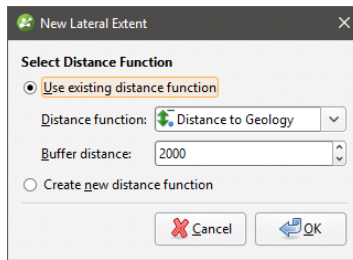

To use an existing function, select it from the list and set a **Buffer distance**. Click **OK** to create the lateral extent.

When you create a new distance function, it will be part of the interpolant's **Boundary** object and will not be available elsewhere in the project. To share it within the project, expand the lateral extent in the project tree and right-click on the distance function. Select **Share**. The distance function will be saved to the **Numeric Models** folder.

To change the extent's settings, expand the interpolant's **Boundary** object in the project tree and double-click on the extent. Adjust the **Distance** and **Anisotropy**, if required.

Changing a Lateral Extent's Settings

For lateral extents created from from polylines, GIS data, points and structural data, you can change the extent's settings by double-clicking on it in the project tree.

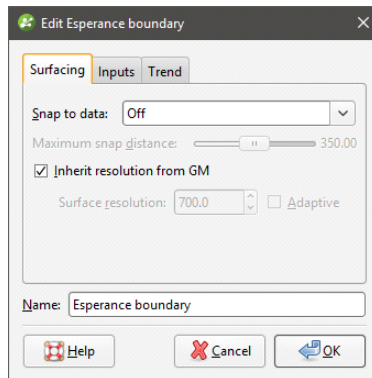

In the **Surfacing** tab, you can change surface resolution and contact honouring options, which are described below. In the **Trend** tab, you can apply a trend to the extent, which is described in [Applying a Trend](#).

Surface Resolution

For RBF interpolants, the resolution of lateral extents is inherited from the settings in the interpolant's **Outputs** tab, but the adaptive isosurfer is automatically disabled. Enter a different **Surface resolution** value, if required, and tick **Adaptive** to enable the adaptive isosurfer.

Contact Honouring

Often, surfaces should honour drillhole data and treat data objects such as polylines and GIS data as interpretations. For extents, the **Snap to data** setting in the **Surfacing** tab determines

whether or not the extent honours the data used to create it. Options are:

- **Off.** The extent does not snap to the data used to create it. This is the default setting.
- **All data.** The extent snaps to all data within the **Maximum snap distance**, which includes drillhole data and any data added to the extent.
- **Drilling only.** The extent snaps to drillhole data and data objects derived from drillhole data within the **Maximum snap distance**, but not to other data used to modify the extent. For example, the extent will honour points data derived from drillhole data, but not points data imported into the **Points** folder.
- **Custom.** The extent snaps to the data objects indicated in the **Inputs** tab that are within the **Maximum snap distance**.

Take care in enabling snapping and in selecting what data the surface will snap to, as the more data you include, e.g. by setting a large **Maximum snap distance** or selecting **All data** for **Snap to data**, the greater the possibility that errors in the data or assumptions inherent in interpretations (e.g. polylines) will cause distortions in the meshes. If you do enable snapping, it is best to snap only to drilling data. See [Honouring Surface Contacts](#) for more information on these settings.

Whatever the setting, you can see what objects are snapped to by clicking on the **Inputs** tab.

If you need the extent to honour drillhole data but treat other data objects as interpretations, select **Drilling only**. To honour some data objects while treating others as interpretations, select **Custom**, then click on the **Inputs** tab to enable snapping for individual objects.

Applying a Trend

You can adjust an extent created from polylines, GIS data, points and structural data by applying a trend to it. To do this, add the extent to the scene. Next, double-click on the extent in the project tree and click the **Trend** tab.

Often the easiest way to apply a trend is to click on the **Draw plane line** button  and draw a plane line in the scene in the direction in which you wish to adjust the surface. You may need to rotate the scene to see the plane properly.

The **Ellipsoid Ratios** determine the relative shape and strength of the ellipsoids in the scene, where:

- The **Maximum** value is the relative strength in the direction of the green line on the moving plane.
- The **Intermed.** value is the relative strength in the direction perpendicular to the green line on the moving plane.
- The **Minimum** value is the relative strength in the direction orthogonal to the plane.

Once you have adjusted the plane to represent the trend you wish to use, click the **Set From Plane** button to copy the moving plane settings.

The **Set to** list contains a number of different options Leapfrog Geo has generated based on the data used in the project. **Isotropic** is the default option used when the extent was created. Settings made to other surfaces in the project will also be listed, which makes it easy to apply the same settings to many surfaces.

Click **OK** to apply the changes.

See [Global Trends](#) for more information.

Adding Data to an Extent

Extents created from polylines, GIS data, points and structural data can be modified by adding points data objects, GIS vector data and structural data. Extents created from a distance to points function can be modified by adding points data and GIS vector data. To add data to an extent, right-click on the extent in the project tree and select the data type you wish to use from the **Add** menu.

- Points data. Select from the points data objects available in the project and click **OK**.
- GIS vector data. Select from the GIS vector data available in the project and click **OK**.
- Structural data. Select from the structural data tables available in the project. If the selected table has query filters defined, you can apply one of these filters by ticking **Use query filter** and then selecting the required filter from the list. Click **OK** to add the selected data to the extent. An alternative to adding an existing structural data table to an extent is to edit the extent with structural data. This is described in [Editing an Extent with Structural Data](#) below.

You can also add a polyline that already exists in the project. To do this, right-click on the extent in the project tree and select **Add > Polyline**. You will be prompted to choose from the polylines in the **Polylines** folder.

Editing an Extent with a Polyline

You can edit an extent using a polyline, which is described in [Editing Surfaces with Polylines](#). A polyline used to edit an extent will be added to the project tree as part of the extent. To edit the polyline, right-click on it and select **Edit Polyline** or add it to the scene and click the **Edit** button () in the shape list. If you wish to remove the polyline from the extent, right-click on it in the project tree and select **Delete** or **Remove**.

To add an existing polyline to a lateral extent, use the **Add > Polyline** option.

Editing an Extent with Structural Data

You can edit an extent using structural data, which is described in [Editing Surfaces with Structural Data](#). A structural data table will be added to the project tree as part of the extent. To edit the table, right-click on it and select **Edit In Scene** or add it to the scene and click the **Edit** button () in the shape list. If you wish to remove the table from the extent, right-click on it in the project tree and select **Delete** or **Remove**.

Removing an Extent from an Interpolant

If you have defined an extent and want to remove it from the interpolant, there are two options. The first is to right-click on the extent in the project tree and click **Delete**. This deletes the extent from the interpolant, but does not delete parent objects from the project unless they were

created as part of the interpolant, e.g. a polyline used as a lateral extent but not shared within the project. Use this option only if you are sure you do not want to use the extent.

The second method is useful if you are making changes to the extent and do not want to recompute the interpolant with each change. Double-click on the interpolant's **Boundary** object or double-click on the interpolant and click on the **Boundary** tab. The **Boundaries** part of the window lists all objects used as extents for the interpolant. Untick the box for extents to temporarily disable them in the interpolant. The interpolant will be reprocessed, but you can then work on the extent without reprocessing the interpolant. Disabled extents will be marked as inactive in the project tree.

Changing the Settings for an RBF Interpolant

To change the settings for an RBF interpolant, you can either double-click on the interpolant in the **Numeric Models** folder or right-click and select **Open**. When creating an RBF interpolant, only a basic set of parameters is used. The **Edit RBF Interpolant** window provides finer controls over these basic parameters so you can refine the interpolant to factor in real-world observations and account for limitations in the data.

For a multi-domained RBF interpolant, these parameters can be changed for the parent interpolant, and the trend, clipping, transformation and interpolation settings can be changed for the sub-interpolants.

Adjusting the Values Used

The **Values** tab in the **Edit Interpolant** window shows the values used in creating the interpolant and provides options for filtering the data. Although you cannot change the values used to create an interpolant, you can filter the values using the **Query filter** and **Surface filter** options.

You can adjust the values using a contour polyline or by adding points. Both options are available by expanding the interpolant in the project tree, then right-clicking on the values object:

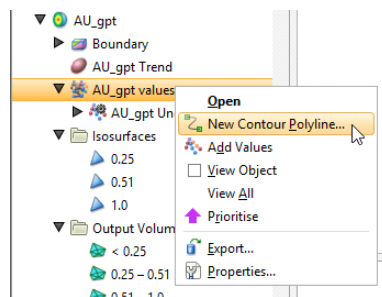

These options are described below in [Adding a Contour Polyline](#) and [Adding Points](#).

To apply a query filter, tick the **Query filter** box in the **Values** tab and select the available queries from the list.

To change the object used as the **Surface filter**, select the required object from the list. Note that the list contains an object that defines the interpolant's own boundary, which can be adjusted in the **Boundary** tab.

Adding a Contour Polyline

Adding a contour polyline is a useful tool for manually adjusting a surface to make it more geologically reasonable. To start adding a contour polyline, draw a slice where you wish to adjust the surface and decide what value you will assign to the contour line. Next, right-click on the values object and select **New Contour Polyline**. The next step is to choose whether you will draw a new polyline or use one already in the project:

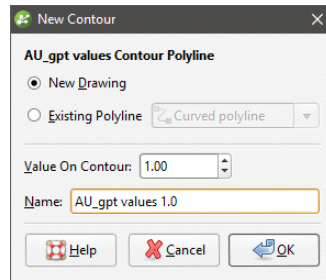

Only GIS lines, polylines imported into Leapfrog Geo or polylines created using the straight line drawing tool can be used to create contour lines.

Enter the value to be used for the contour and a name for it. Click **OK**. If you have chosen the **New Drawing** option, the new object will be created in the project tree and drawing tools will appear in the scene. Start drawing in the scene as described in [Drawing in the Scene](#). When you have finished drawing, click the **Save** button (💾). The new contour will automatically be added to the interpolant and will appear in the project tree as part of the interpolant’s values object.

To change the value assigned to a contour polyline, double-click on the interpolant in the project tree. In the **Values** tab, contour polylines and their assigned values are shown in the **User contour values** table:

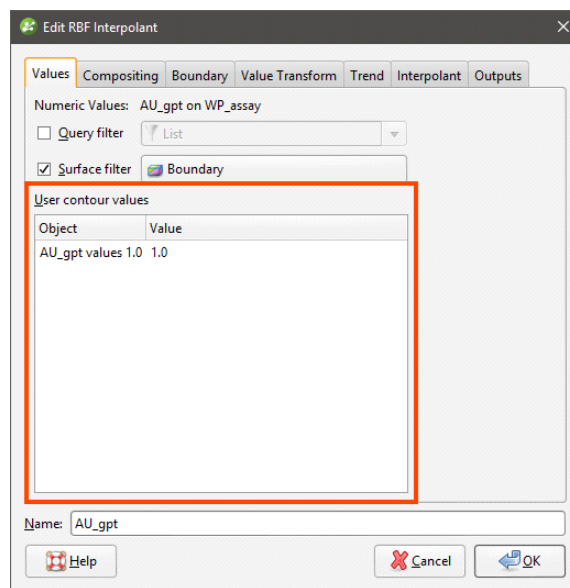

To change the value on a contour, click in the **Value** column and edit the entry.

To edit the polyline, right-click on it in the project tree and select **Edit Polyline** or add it to the scene and click the **Edit** button (✎) in the shape list. If you wish to remove a contour polyline

from the interpolant, right-click on it in the project tree and select **Delete** or **Remove**.

Adding Points

To add points to an RBF interpolant, right-click on the values object in the project tree and select **Add Values**. Leapfrog Geo will display a list of all suitable points objects in the project. Select an object and click **OK**.

A hyperlink to the points object will be added to the values object in the project tree. To remove the points object, right-click on the points object and select **Remove**.

Compositing Parameters for an RBF Interpolant

When an RBF interpolant has been created from data that has not been composited, compositing parameters can be changed by double-clicking on the interpolant in the project tree, then clicking on the **Compositing** tab.

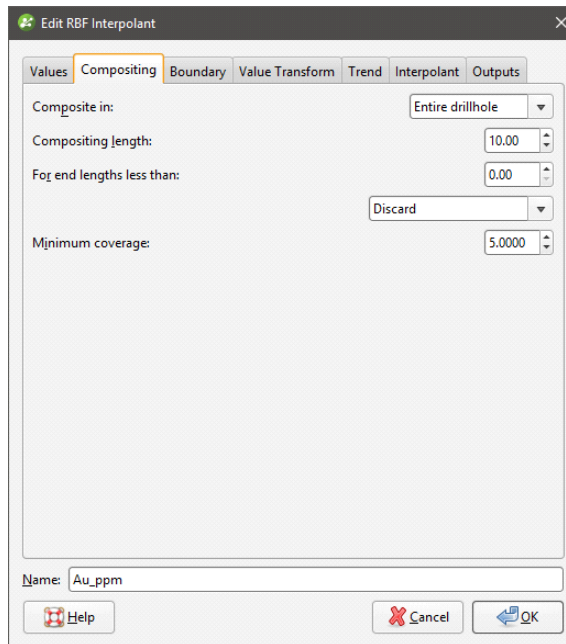

The **Compositing** tab will only appear for interpolants created from drillhole data that has not been composited.

You can composite in the entire drillhole or only where the data falls inside the interpolant boundary. See [Numeric Composites](#) for more information on the effects of the **Compositing length**, **For end lengths less than** and **Minimum coverage** settings.

Adjusting the Interpolant Boundary

See [Modifying an RBF Interpolant's Boundary with Lateral Extents](#) above for information on creating and working with lateral extents.

To change an RBF interpolant's boundary, double-click on the interpolant in the project tree, then click on the **Boundary** tab:

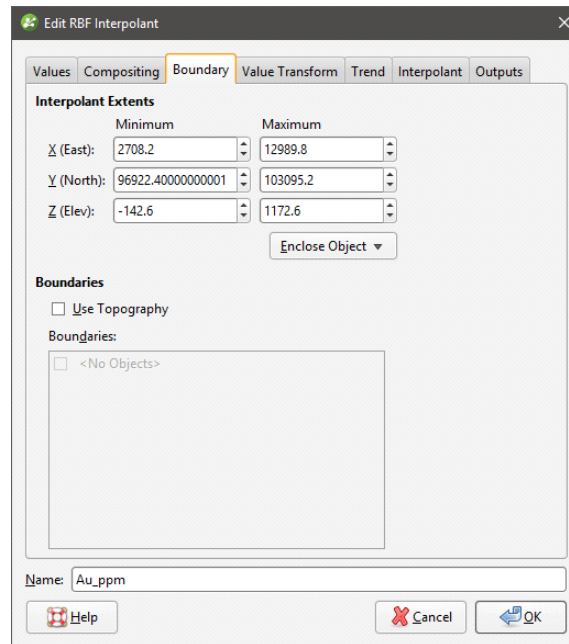

Controls to adjust the boundary will also appear in the scene.

Tick the **Use Topography** box to use the topography as a boundary. The topography is normally not used as a boundary for interpolants and so this option is disabled when an interpolant is first created.

The **Boundaries** list shows objects that have been used to modify the boundary. You can disable any of these lateral extents by unticking the box.

Lateral extents can be used to restrict modelling to a particular area of interest; for example, modelling can be restricted to a known distance from drillholes by applying a distance function as a lateral extent.

Clipping and Transforming Values for an RBF Interpolant

To clip data and apply a transformation to an RBF interpolant, double-click on the interpolant in the project tree, then click on the **Value Transform** tab:

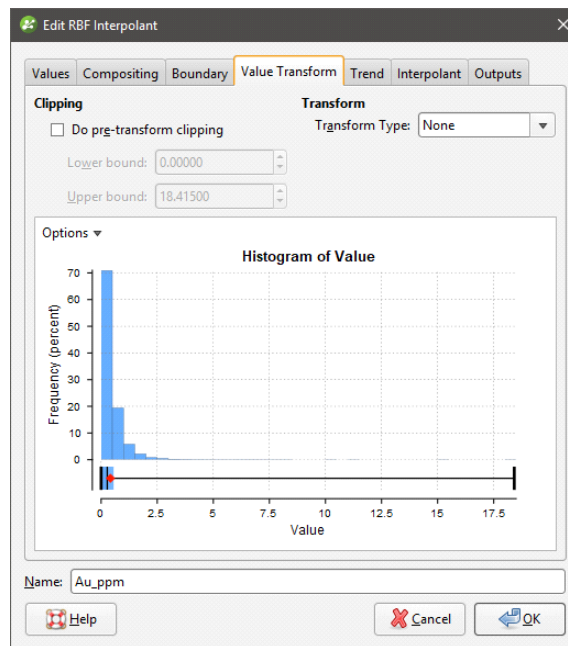

The options for **Transform Type** are **None** and **Log**. **Log** uses a natural logarithm to compress the data values to a smaller range. This may be useful if the data range spans orders of magnitude. The function used is:

$$\ln(x+s)+c$$

where s is the **Pre-log shift** and c is a constant. In order to avoid issues with taking the logarithm of zero or a negative number, **Pre-log shift** is a constant added to make the minimum value positive. The value of the pre-log shift will automatically be chosen to add to the minimum value in the data set to raise it to 0.001. This constant is then added to all the data samples. You can modify the value of the **Pre-log shift**, as increasing this value further away from zero can be used to reduce the effect of the natural logarithm transformation on the resultant isosurfaces.

Note that a further constant, c , is added to the natural logarithm of the data with the pre-log shift added to it. If there are any negative numbers that result from taking the natural log of the data, the absolute value of the most negative number is taken and added to all the transformed data results. This will raise the value of all the data so the minimum data value is zero. The value of c is chosen automatically and cannot be modified.

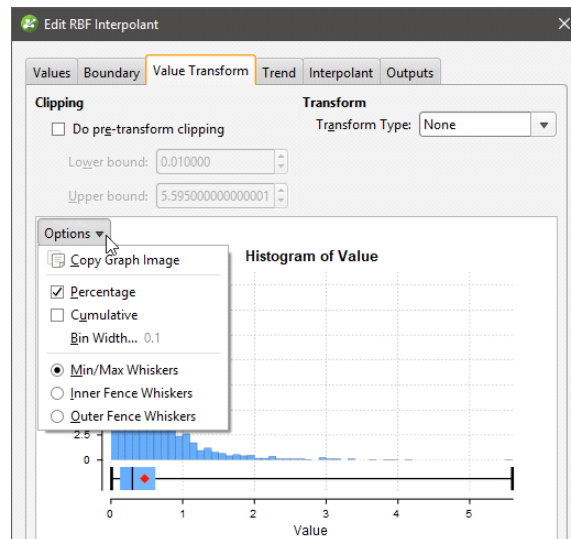

Click on the **Options** button to change the histogram's display, including the **Bin Width**.

If you tick the **Do pre-transform clipping** option, you can set the **Lower bound** and the **Upper bound** to cap values that are too low or too high. For example, if you set the **Upper bound** from 14.00 to 10.00, grade values above 10.00 will be regarded as 10.00.

Changing the Trend for an RBF Interpolant

You can apply a global trend or a structural trend to an RBF interpolant. To do this, add the interpolant to the scene, then double-click on the interpolant in the project tree. Click on the **Trend** tab in the **Edit RBF Interpolant** window.

See:

- [Using a Global Trend](#)
- [Using a Structural Trend](#)

Using a Global Trend

The easiest way to change the trend applied to an interpolant is using a global trend set from the moving plane.

Click **View Plane** to add the moving plane to the scene, then click on the plane to view its controls. You may need to hide part of the interpolant to click on the moving plane:

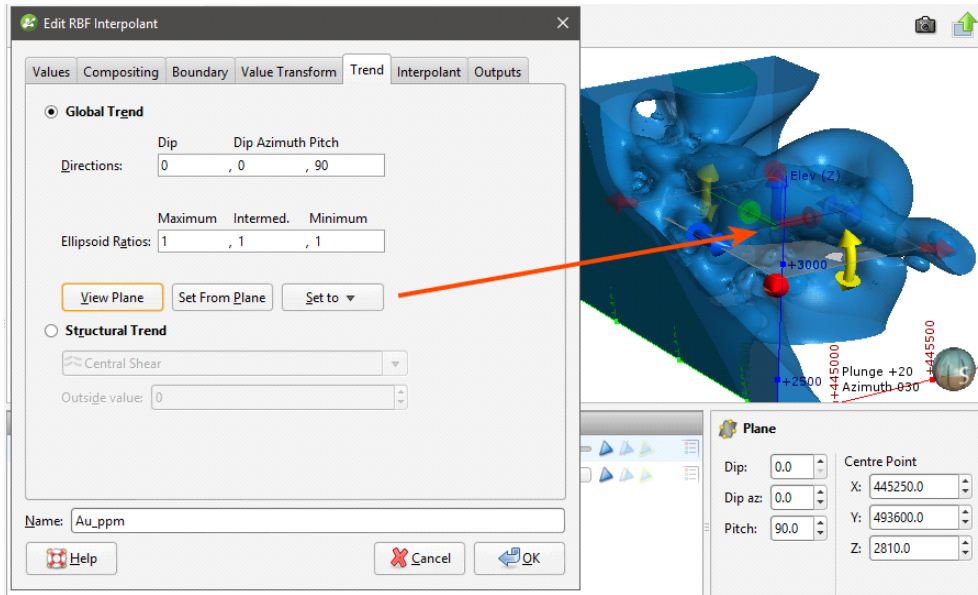

You can also use the **Set to** list to choose different options Leapfrog Geo has generated based on the data used to build the interpolant. **Isotropic** is the default option used when the interpolant is created.

The **Ellipsoid Ratios** determine the relative shape and strength of the ellipsoids in the scene, where:

- The **Maximum** value is the relative strength in the direction of the green line on the moving plane.
- The **Intermed.** value is the relative strength in the direction perpendicular to the green line on the moving plane.
- The **Minimum** value is the relative strength in the direction orthogonal to the plane.

Click **OK** to regenerate the interpolant and view changes.

Using a Structural Trend

You can also set the trend for an RBF interpolant from a structural trend. First, you must create or import the required mesh and create a structural trend. See [Structural Trends](#) for more information.

Once the structural trend has been created, add it to the interpolant by double-clicking on the interpolant in the project tree, then clicking on the **Trend** tab. Select the **Structural Trend** option, then select the required trend from the list:

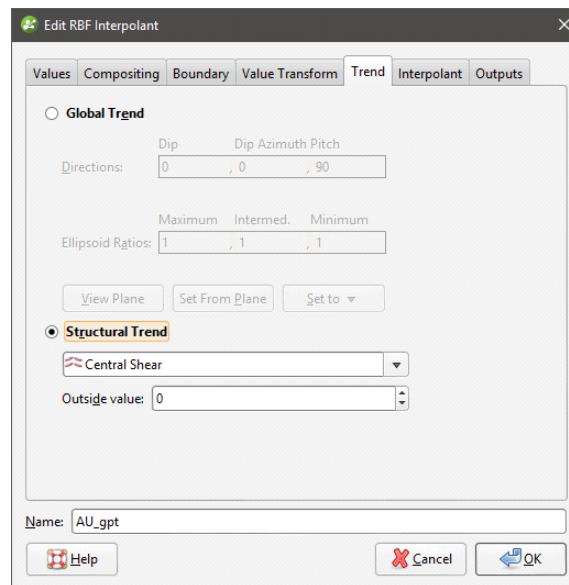

Click **OK**. The trend will be added to the interpolant and will appear as part of the interpolant, as shown:

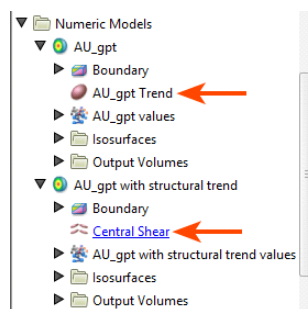

When you apply a structural trend, you cannot use the **Linear** interpolant. See [Interpolant Functions](#) for more information.

Once a structural trend has been defined for the interpolant, you can edit it by clicking on the trend hyperlink in the project tree, then opening the structural trend applied to the interpolant. The **Structural Trend** window will appear. See [Structural Trends](#) for information on the settings in this screen.

The structural trend information included as part of the interpolant is a link to the original structural trend. When you change the structural trend that is part of the interpolant, the changes are also made for the original structural trend.

When a structural trend that is **Strongest along meshes** or **Blending** is used, the interpolant will regress to the global mean trend away from the meshes. The global trend that will be used is set in the **Global Trend** tab for the structural trend.

Adjusting Interpolation Parameters

To adjust interpolation parameters for an RBF interpolant, double-click on the interpolant in the project tree, then click on the **Interpolant** tab:

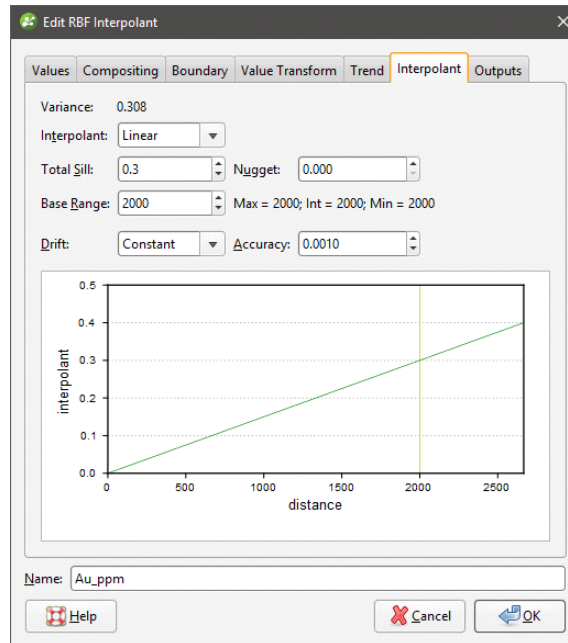

Two models are available, the spheroidal interpolant and the linear interpolant. See [The Spheroidal Interpolant Function](#) and [The Linear Interpolant Function](#) for more information on the settings in this tab.

Output Settings for an RBF Interpolant

You can change the parameters used to generate RBF interpolant outputs by double-clicking on the interpolant, then clicking on the **Outputs** tab.

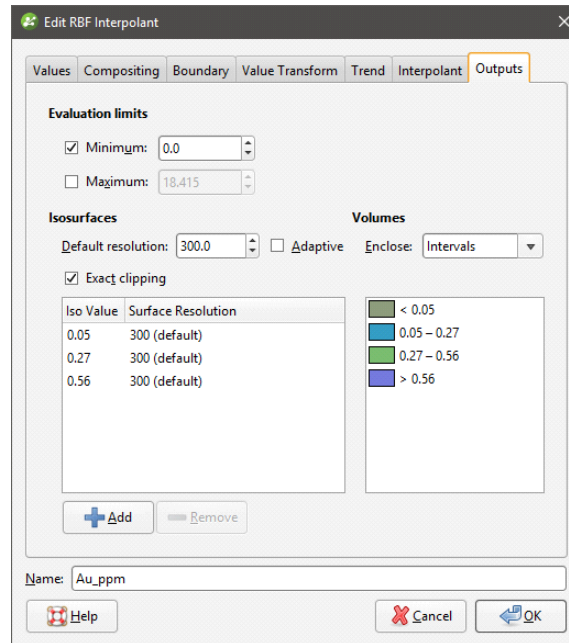

The **Evaluation limits** apply when interpolants are evaluated against other objects in the project. When the limits are enabled, all values outside the limits will be set to the **Minimum** and **Maximum**.

When **Exact clipping** is enabled, the interpolant isosurface will be generated without “tags” that overhang the interpolant boundary. This setting is enabled by default when you create an interpolant.

To add a new isosurface, click the **Add** button and enter the required value. To delete an isosurface, click on it in the list, then click the **Remove** button. You can also change the colours used to display the isosurfaces by clicking on the colour chips.

If you find that grade shells are overlapping, the resolution may be too coarse. Set **Default resolution** to a lower value or enable adaptive resolution in the **Outputs** tab. See [Surface Resolution in Leapfrog Geo](#).

Multi-Domained RBF Interpolants

This topic describes creating and editing multi-domained RBF interpolants:

- [Creating a Multi-Domained RBF Interpolant](#)
- [Compositing and Filtering the Values Used](#)
- [Selecting Domains](#)
- [Clipping and Transforming Values](#)

- [Setting the Trend](#)
- [Interpolation Parameters](#)
- [Output Options](#)
- [The Multi-Domained RBF Interpolant in the Project Tree](#)
- [Interpolant and Sub-Interpolant Display](#)
- [Sub-Interpolant Statistics](#)

A multi-domained RBF interpolant is an RBF interpolant that has a number of individual sub-interpolants bounded by the domains of a geological model.

- Changes to all sub-interpolants can be made by editing the parent interpolant.
- Sub-interpolants can be edited to account for local influences on the values used, the trend and interpolation parameters.

A multi-domained RBF interpolant is a single object that can be evaluated as a single column on points and block models.

Creating a Multi-Domained RBF Interpolant

Creating a multi-domained RBF interpolant is a two-step process:

- Selecting the values to be used and the domains in which sub-interpolants will be created.
- Setting the multi-domained RBF interpolant’s properties.

To start creating a multi-domained RBF interpolant, right-click on the **Numeric Models** folder and select **New Multi Domained RBF Interpolant**. The **New Multi-domained RBF Interpolant** window will be displayed:

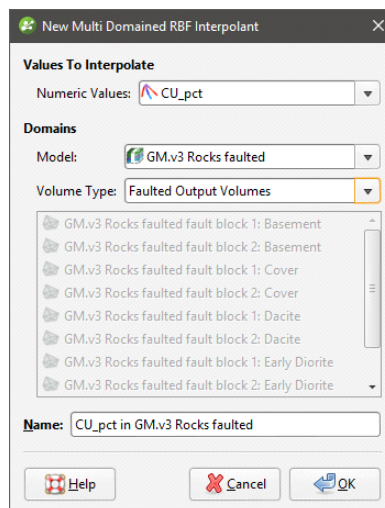

In this window, select the basic parameters for the multi-domained RBF interpolant. You will be able to set additional properties once you click **OK**.

- Select the **Values To Interpolate** from the suitable data available in the project. You will be able to change how data is filtered at the next step, but you will not be able to change the

values used.

- Select the domains used to generate sub-interpolants. These options cannot be changed once the multi-domained RBF interpolant has been created, although you will be able to select which volumes are used to generate sub-interpolants.
 - Select from the geological models available in the project.
 - If the selected **Model** has no faults defined, the **Volume Type** will be set to output volumes.
 - If the selected **Model** is a faulted model, the **Volume Type** can be output volumes, faulted output volumes or fault blocks.

Click **OK** to move on to the next step. The **Edit RBF Interpolant** window will appear:

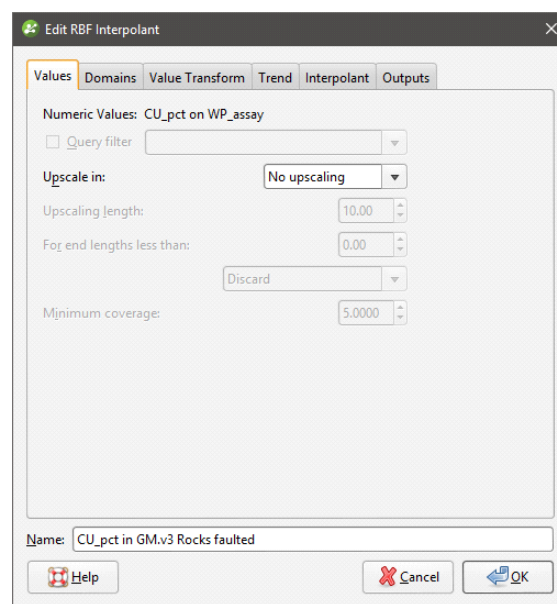

Compositing and Filtering the Values Used

In the **Values** tab, you can apply any query filters that have been defined for the data used.

When numeric values from drillhole data are used to create an interpolant, there are two approaches to compositing that data:

- Composite the drillhole data, then use the composited values to create an interpolant. If you select composited values to create an interpolant, compositing options will be disabled.
- Use drillhole data that hasn't been composited to create an interpolant, then apply compositing settings to the interpolated values. If you are interpolating values that have not been composited and do not have specific **Compositing** values in mind, you may wish to leave this option blank as it can be changed once the model has been created.

If you are interpolating points, compositing options will be disabled.

See [Numeric Composites](#) for more information on the effects of the **Compositing length**, **For end lengths less than** and **Minimum coverage** settings.

Selecting Domains

In the **Domains** tab, you can select the volumes in which sub-interpolants will be generated. You cannot, however, change the geological model or the types of volumes used.

Clipping and Transforming Values

In the **Value Transform** tab, clip data and apply a transformation, if required. See [Clipping and Transforming Values for an RBF Interpolant](#) for more information about the settings in this tab.

You will be able to change the **Value Transform** settings for individual sub-interpolants once the parent interpolant has been created.

Setting the Trend

In the **Trend** tab, you can apply a global or structural trend to the interpolant. See [Changing the Trend for an RBF Interpolant](#) for more information about these options.

You will be able to change the **Trend** settings for the interpolant and individual sub-interpolants once the parent interpolant has been created.

Interpolation Parameters

In the **Interpolant** tab, you can change interpolation parameters. See [Adjusting Interpolation Parameters](#) for more information about these options.

You will be able to change the **Interpolant** settings or import variogram parameters for the interpolant and individual sub-interpolants once the parent interpolant has been created.

Output Options

In the **Outputs** tab, you can change the parameters used to generate interpolant outputs.

The **Evaluation limits** apply when interpolants are evaluated against other objects in the project. When the limits are enabled, all values outside the limits will be set to the **Minimum** and **Maximum**.

Set the **Default resolution** for the interpolant and whether or not the resolution is adaptive. See [Surface Resolution in Leapfrog Geo](#) for more information on the effects of these settings. The resolution can be changed once the interpolant has been created, so setting a value when creating the parent interpolant is not vital. A lower value will produce more detail, but calculations will take longer.

When **Exact clipping** is enabled, the interpolant isosurface will be generated without "tags" that overhang the interpolant boundary. This setting is enabled by default when you create an interpolant.

To add a new isosurface, click the **Add** button and enter the required value. To delete an isosurface, click on it in the list, then click the **Remove** button. You can also change the colours used to display the isosurfaces by clicking on the colour chips.

The **Volumes enclose** option determines whether the interpolant volumes enclose **Higher Values**, **Lower Values** or **Intervals**. This option can be changed once the interpolant has been created.

Enter a **Name** for the new interpolant and click **OK**.

Once you have created a multi-domained RBF interpolant, you can adjust its properties as described in [Changing the Settings for an RBF Interpolant](#). You can also change trend, clipping, transformation and interpolation settings for a sub-interpolant. To do this, double-click on a sub-interpolant. For the settings you wish to change, untick the **Inherit parameters from parent** box:

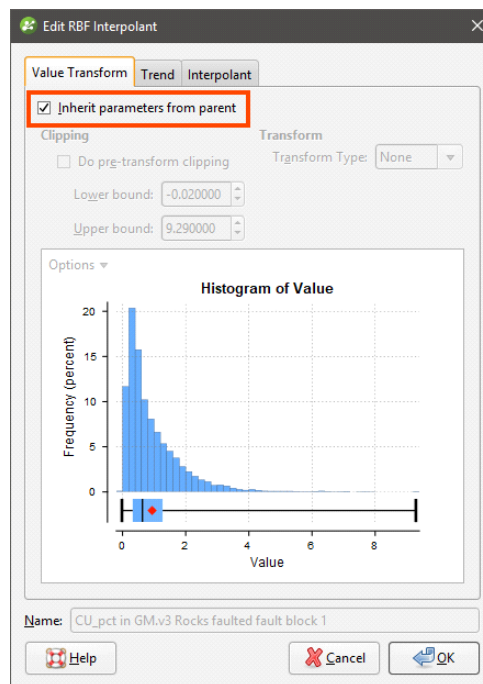

See also:

- [Importing a Variogram Model](#)
- [Copying a Numeric Model](#)
- [Creating a Static Copy of a Numeric Model](#)
- [Exporting Numeric Model Volumes and Surfaces](#)

The Multi-Domained RBF Interpolant in the Project Tree

The new multi-domained RBF interpolant will be created and added to the **Numeric Models** folder. It contains objects that represent different parts of the interpolant:

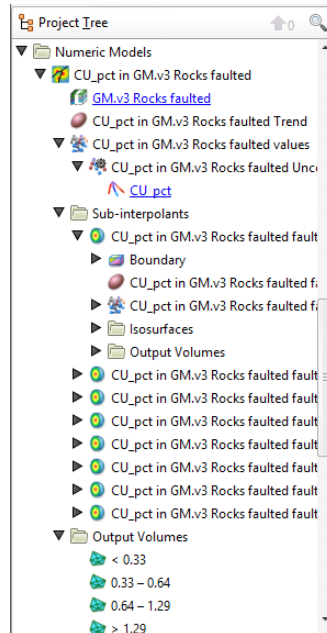

- There is a link to the geological model from which domains are selected for the sub-interpolants.
- The **Trend** object describes the trend applied in the interpolant. See [Changing the Trend for an RBF Interpolant](#) for more information.
- The points data values object contains all the data used in generating the interpolant. See [Adjusting the Values Used](#) for more information.
- The **Sub-interpolants** folder contains the sub-interpolants, which can be edited to change the trend, clipping, transformation and interpolation settings.
- The **Output Volumes** folder contains all the volumes generated in building the interpolant.

Other objects may appear in the project tree under the interpolant as you make changes to it.

Interpolant and Sub-Interpolant Display

Display the interpolant by:

- Dragging the interpolant into the scene or right-clicking on the interpolant and selecting **View Output Volumes**. Both actions display the parent interpolant's output volumes.
- Right-clicking on the interpolant and selecting **View Isosurfaces**. This displays the isosurfaces of each sub-interpolant.

Sub-Interpolant Statistics

You can view the approximated mean for each output volume of a sub-interpolant by right-clicking on the sub-interpolant and selecting **Properties**. Click on the **Statistics** tab:

Approx. Mean			
Interval	Interval Volume	Value	Units
< 0.33	462728.981104	0.33	152700.563764
0.33-0.64	5908102.83111	0.485	2865429.87309
0.64-1.29	32534206.7592	0.965	31395509.5226
> 1.29	0	1.29	0
Approx. Total:			34,413,640

If the original data were specified as concentrations, then the values will need to be multiplied by a density to produce weights.
For example, if the original data were in grams/ton and distances have been specified in metres, then the values will need to be multiplied by the specific gravity (tons/m³) to produce grams.

You can copy the information displayed in the **Statistics** tab to the clipboard for use in other applications.

Indicator RBF Interpolants

An indicator RBF interpolant is a useful way of creating a region of interest in which further processing can be carried out. For example, you can use an indicator RBF interpolant to define a volume that encloses the values that are likely to be above a cut-off threshold and then carry out further interpolation inside that volume.

The rest of this topic describes how to create and modify indicator RBF interpolants. It is divided into:

- [Creating an Indicator RBF Interpolant](#)
- [The Indicator RBF Interpolant in the Project Tree](#)
- [Indicator RBF Interpolant Display](#)
- [Indicator RBF Interpolant Statistics](#)
- [Editing an Indicator RBF Interpolant](#)

Creating an Indicator RBF Interpolant

To create an indicator RBF interpolant, right-click on the **Numeric Models** folder and select **New Indicator RBF Interpolant**. The **New Indicator RBF Interpolant** window will be displayed:

The screenshot shows the 'New Indicator RBF Interpolant' dialog box with the following settings:

- Values To Interpolate:**
 - Numeric values: Ag_ppm
 - Cut-off: ≥ 1.0
 - Query Filter: (empty)
 - Surface Filter: Surface Filter
 - Interpolant Boundary: Interpolant Boundary
 - Other: Other (Select surface...)
- Interpolant Boundary:**
 - Custom: Custom
 - Existing model boundary or volume: Existing model boundary or volume (Select surface...)
 - Minimum/Maximum:

	Minimum	Maximum
X (East):	387568.476109	397113.572180
Y (North):	5390742.15490	5400965.96368
Z (Elev):	-1240.0	1640.0
- Compositing:**
 - Composite in: No compositing
 - Compositing length: 10.00
 - For end lengths less than: 0.00
 - Discard: (empty)
 - Minimum coverage: 5.0000
- General:**
 - Surface resolution: 300.0
 - Adaptive: Adaptive
 - Iso value: 0.5
- Name:** Ag_ppm Indicator 1.0

This window is divided into four parts in which you select the values used to create the interpolant, the interpolant boundary, any compositing options and general interpolant properties.

If you are unsure of some settings, most can be changed later. However, the **Numeric values** object selected when the interpolant is created cannot be changed.

Selecting the Values Used

In the **Values To Interpolate** part of the **New Indicator RBF Interpolant** window, you can select the values that will be used and choose whether or not to filter the data and use a subset of those values in the interpolant.

You can build an indicator RBF interpolant from either:

- Numeric data contained in imported drillhole data.
- Points data imported into the **Points** folder.

All suitable data in the project is available from the **Numeric values** list.

Setting the Cut Off

The **Cut-off** value will be used to generate sample points and create two output volumes:

- An **Inside** volume that encloses all values likely to be above or equal to the **Cut-off** value.
- An **Outside** volume that enclose all values likely to be below the **Cut-off** value.

If you are unsure of what **Cut-off** value to use, you can view statistics on the distribution of the data and change the **Cut-off** value once the interpolant has been created.

You can change the names of the **Inside** and **Outside** volumes once the interpolant has been created.

Applying a Query Filter

If you have defined a query filter and wish to use it to create the interpolant, select the filter from the **Query filter** list. Once the model has been created, you can remove the filter or select a different filter.

Applying a Surface Filter

All available data can be used to generate the interpolant or the data can be filtered so that only the data that is within the interpolant boundary or another boundary in the project influences the interpolant. The **Surface Filter** option is enabled by default, but if you wish to use all data in the project, untick the box for **Surface Filter**. Otherwise, you can select the **Interpolant Boundary** or another boundary in the project.

You can use both the **Query Filter** option and the **Surface Filter** option together.

The Interpolant Boundary

There are several ways to set the **Interpolant Boundary**:

- Enter values to set a **Custom** boundary.
- Use the controls in the scene to set the **Custom** boundary dimensions.
- Select another object in the project from the **Enclose Object** list, which could be the numeric values object being interpolated. The extents for that object will be used as the basis for the **Custom** boundary dimensions.
- Select another object in the project to use as the **Interpolant Boundary**. Click the **Existing model boundary or volume** option and select the required object from the list.

Once the interpolant has been created, you can further modify its boundary. See [Modifying an RBF Interpolant's Boundary with Lateral Extents](#) and [Adjusting the Interpolant Boundary](#) in the [RBF Interpolants](#) topic for more information.

Compositing Options

When numeric values from drillhole data are used to create an interpolant, there are two approaches to compositing that data:

- Composite the drillhole data, then use the composited values to create an interpolant. If you select composited values to create an interpolant, compositing options will be disabled.
- Use drillhole data that hasn't been composited to create an interpolant, then apply compositing settings to the interpolated values. If you are interpolating values that have not been composited and do not have specific **Compositing** values in mind, you may wish to leave this option blank as it can be changed once the model has been created.

If you are interpolating points, compositing options will be disabled.

See [Numeric Composites](#) for more information on the effects of the **Compositing length**, **For end lengths less than** and **Minimum coverage** settings.

General Interpolant Properties

Set the **Surface resolution** for the interpolant and whether or not the resolution is adaptive. See [Surface Resolution in Leapfrog Geo](#) for more information on the effects of these settings. The resolution can be changed once the interpolant has been created, so setting a value in the **New Indicator RBF Interpolant** window is not vital. A lower value will produce more detail, but calculations will take longer.

An indicator RBF interpolant produces a single isosurface that is used to determine the likelihood of values falling inside or outside of the cut-off threshold. The **Iso value** can be set to values from 0.1 to 0.9. Clicking the arrows changes the **Iso value** in steps of 0.1. To use a different value, enter it from the keyboard. Again, this option can be changed once the interpolant has been created.

Enter a **Name** for the new interpolant and click **OK**.

Once you have created an interpolant, you can adjust its properties by double-clicking on it. You can also double-click on the individual objects that make up the interpolant.

See also:

- [Copying a Numeric Model](#)
- [Creating a Static Copy of a Numeric Model](#)
- [Exporting Numeric Model Volumes and Surfaces](#)

The Indicator RBF Interpolant in the Project Tree

The new interpolant will be created and added to the **Numeric Models** folder. The new interpolant contains other objects that represent different parts of the interpolant:

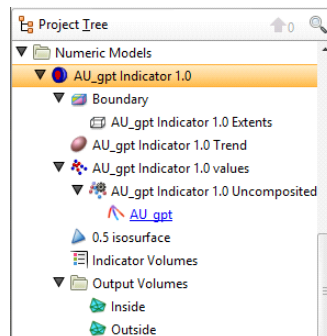

- The **Boundary** object defines the limits of the interpolant. See [Adjusting the Interpolant Boundary](#).
- The **Trend** object describes the trend applied in the interpolant. See [Changing the Trend for an Indicator RBF Interpolant](#).

- The sample grouping object (🌐) is the inside/outside sample grouping, which is generated by backflagging the indicator calculations on the values used (🌐). See [Adjusting the Values Used](#) for information on changing settings relating to how the sample points are grouped.
- The isosurface is set to the specified **Iso value**.
- The **Indicator Volumes** legend defines the colours used to display the volumes.
- The **Output Volumes** folder contains the **Inside** and **Outside** volumes.

Other objects may appear in the project tree under the interpolant as you make changes to it. See [Editing an Indicator RBF Interpolant](#) below for more information on the changes you can make.

Indicator RBF Interpolant Display

Display the interpolant by:

- Dragging the interpolant into the scene or right-clicking on the interpolant and selecting **View Output Volumes**.
- Right-clicking on the interpolant and selecting **View Isosurfaces**.

You can also display the sample grouping (🌐) generated as part of the interpolant, which is useful in making decisions about the **Cut-off** value and the **Iso value**:

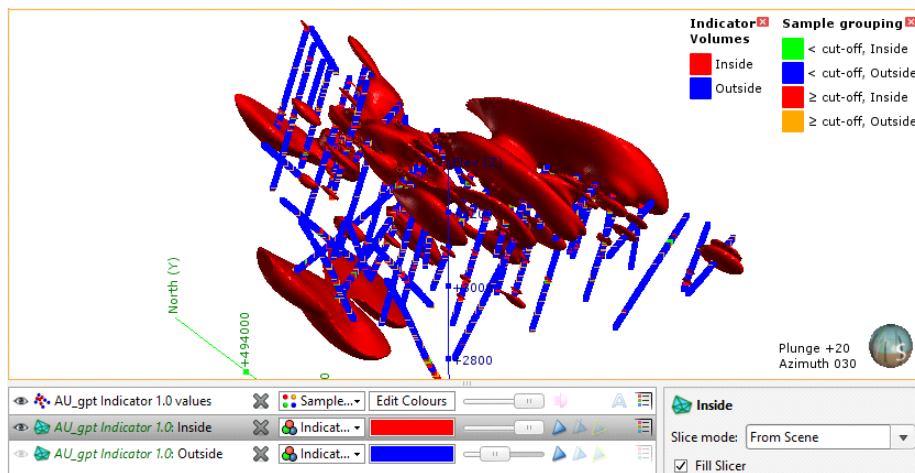

Indicator RBF Interpolant Statistics

You can view the statistics for the indicator RBF interpolant by right-clicking on the interpolant and selecting **Statistics**. Use the information available to adjust the cut-off value and other interpolant properties:

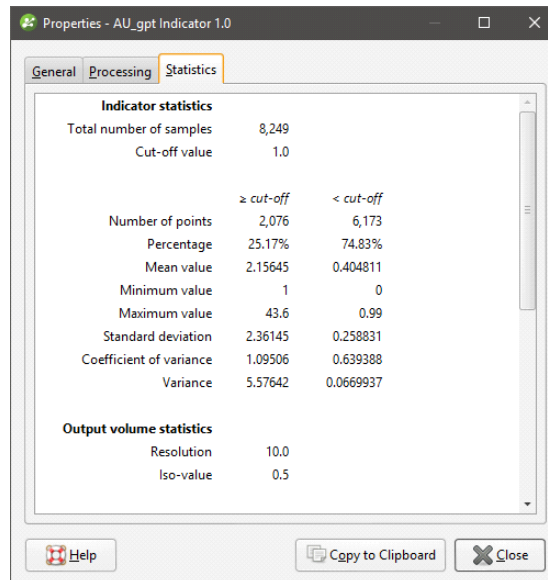

You can copy the information displayed in the **Statistics** tab to the clipboard for use in other applications.

Editing an Indicator RBF Interpolant

To edit an indicator RBF interpolant, you can either double-click on the interpolant in the **Numeric Models** folder or right-click and select **Open**. The window that appears is divided into tabs that let you change the different objects that make up the interpolant. Many of the options are the same for RBF and multi-domained RBF interpolants.

When creating an indicator RBF interpolant, only a basic set of parameters is used. The **Edit Indicator RBF Interpolant** windows provide finer controls over these basic parameters so you can refine the interpolant to factor in real-world observations and account for limitations in the data.

- [Adjusting the Values Used](#)
- [Compositing Parameters for an Indicator RBF Interpolant](#)
- [Adjusting the Interpolant Boundary](#)
- [The Cut-Off Value](#)
- [Changing the Trend for an Indicator RBF Interpolant](#)
- [Adjusting Interpolation Parameters](#)
- [Indicator RBF Interpolant Surfacing and Volume Options](#)

Adjusting the Values Used

The **Values** tab in the **Edit Indicator RBF Interpolant** window shows the values used in creating the interpolant and provides options for filtering the data. You cannot change the values used, but you can filter the values using the **Query filter** and **Surface filter** options.

The sample grouping object (🌐) in the project tree is not the values used, but is instead the inside/outside sample grouping generated by backflagging the indicator calculations on the input values (🌐). You can adjust the input values using a contour polyline or by adding points. Both options are available by expanding the interpolant in the project tree, then right-clicking on the sample grouping object (🌐):

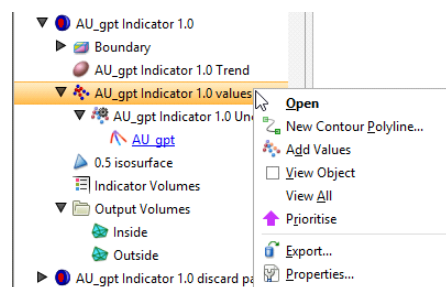

These options are described below in [Adding a Contour Polyline](#) and [Adding Points](#).

To apply a query filter, tick the **Query filter** box in the **Values** tab and select the available queries from the list.

To change the object used as the **Surface filter**, select the required object from the list. Note that the list contains an object that defines the interpolant's own boundary, which can be adjusted in the **Boundary** tab.

Adding a Contour Polyline

You can adjust the values using contour polylines set to inside (1), outside (0) or to the iso-value. Adding a contour polyline does not affect the indicator's statistics.

Setting a contour to inside or outside is a useful way of controlling blowouts. Here, the inside volume occurs in the corner of the model because of the high-value points at the bottom of the drillhole:

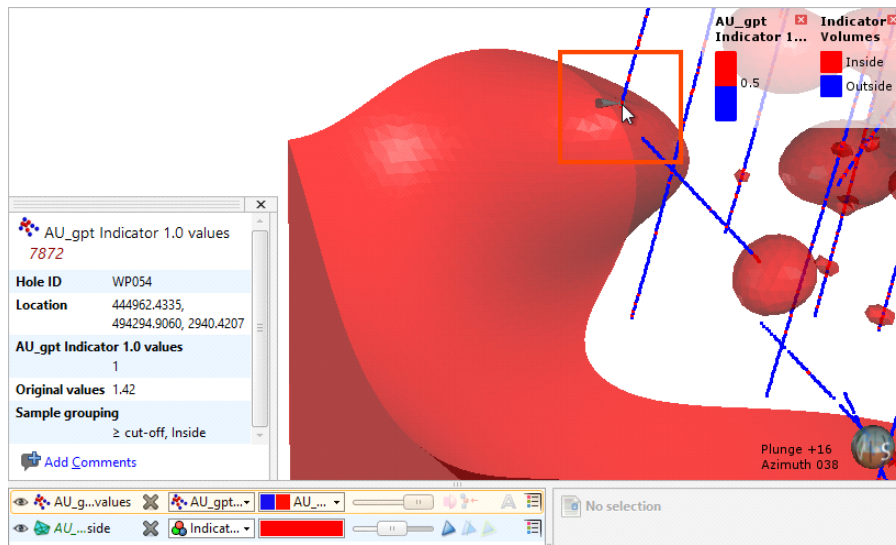

This can be adjusted by drawing a contour polyline below the bottom of the drillholes and setting it to the outside value. For example, adding a polyline (in yellow) below the bottom of drillhole shown above removes the blowout (the part of the mesh with only the edges shown):

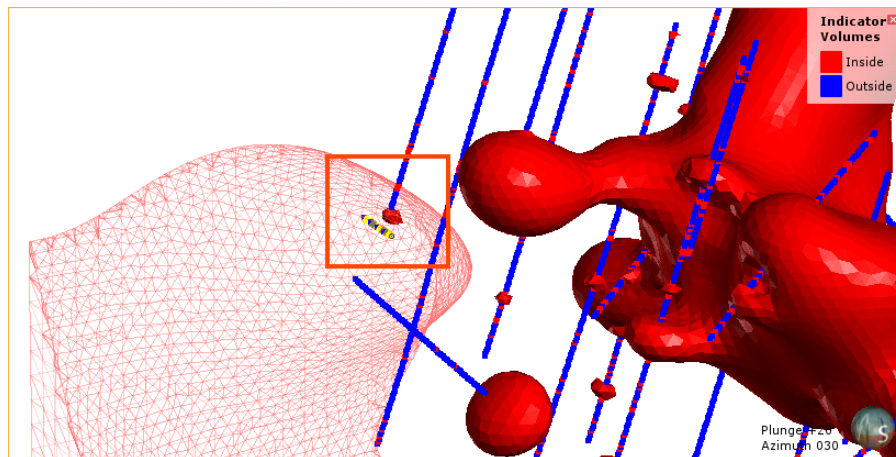

Polylines must be drawn either on an object or on the slicer. Drawing a contour polyline precisely on the drillhole gives Leapfrog Geo conflicting data at the same location, which is why the polyline should be drawn below the drillhole. To draw a polyline below a drillhole, first draw the polyline on the drillhole, then move its nodes so the polyline lies below the drillhole.

To add a contour polyline, expand the interpolant in the project tree. Right-click on the values object and select **New Contour Polyline**:

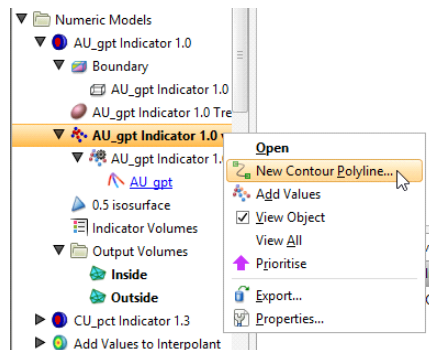

Next, choose whether you will draw a new polyline or use one already in the project, then select the contour value:

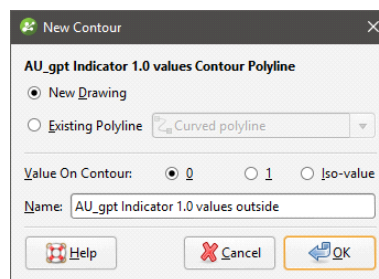

Only GIS lines, polylines imported into Leapfrog Geo or polylines created using the straight line drawing tool can be used to create contour lines.

Click **OK**. If you have chosen the **New Drawing** option, the new object will be created in the project tree and drawing tools will appear in the scene. Start drawing in the scene as described in [Drawing in the Scene](#). When you have finished drawing, click the **Save** button (📁). The new contour will automatically be added to the interpolant and will appear in the project tree as part of the interpolant's values object.

To edit the polyline, right-click on it and select **Edit Polyline** or add it to the scene and click the **Edit** button (✏️) in the shape list. If you wish to remove a contour polyline from the interpolant, right-click on it in the project tree and select **Delete** or **Remove**.

You cannot change the value on the contour once it has been created. You can, however, share the polyline and use it to create a new contour polyline. To do this, right-click on it in the project tree and select **Share**. The polyline will then be added to the **Polylines** folder and can be used elsewhere in the project.

Adding Points

To add points to an indicator RBF interpolant, right-click on the values object in the project tree and select **Add Values**. Leapfrog Geo will display a list of all suitable points objects in the project. Select an object and click **OK**.

A hyperlink to the points object will be added to the values object in the project tree. To remove the points object, right-click on the points object and select **Remove**.

Compositing Parameters for an Indicator RBF Interpolant

When an indicator RBF interpolant has been created from values that have not been composited, compositing parameters can be changed by double-clicking on the interpolant in the project tree, then clicking on the **Compositing** tab.

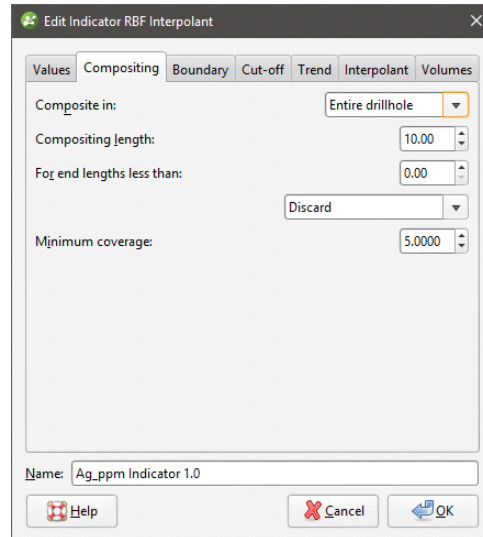

The **Compositing** tab will only appear for interpolants created from drillhole data that has not been composited.

You can composite in the entire drillhole or only where the data falls inside the interpolant boundary. See [Numeric Composites](#) for more information on the effects of the **Compositing length**, **For end lengths less than** and **Minimum coverage** settings.

Adjusting the Interpolant Boundary

To change an indicator RBF interpolant's boundary, double-click on the interpolant in the project tree, then click on the **Boundary** tab:

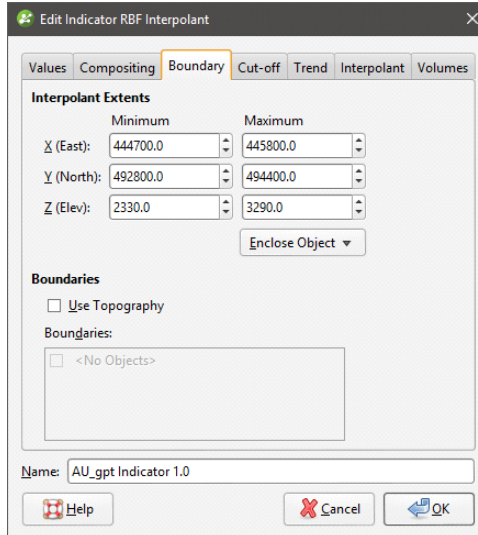

Controls to adjust the boundary will also appear in the scene.

Tick the **Use Topography** box to use the topography as a boundary. The topography is normally not used as a boundary for interpolants and so this option is disabled when an interpolant is first created.

The **Boundaries** list shows objects that have been used to modify the boundary. You can disable any of these lateral extents by unticking the box.

Techniques for creating lateral extents for indicator RBF interpolants are the same as those for RBF interpolants. See [Modifying an RBF Interpolant's Boundary with Lateral Extents](#) for more information.

The Cut-Off Value

To change the **Cut-off** value for an indicator RBF interpolant, double-click on the interpolant in the project tree, then click on the **Cut-off** tab. The tab also shows the distribution of the data used to create an indicator interpolate:

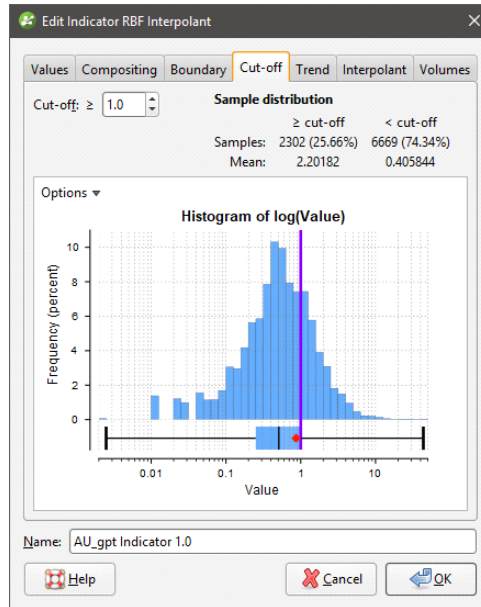

Click on the **Options** button to change the histogram's display, including the **Bin Width**. Adjust the **Cut-off** value, if required, and click **OK** to process the changes.

Changing the Trend for an Indicator RBF Interpolant

You can apply a global trend or a structural trend to an indicator RBF interpolant. To do this, add the interpolant to the scene, then double-click on the interpolant in the project tree. Click on the **Trend** tab in the **Edit Indicator RBF Interpolant** window.

Techniques for setting a trend for an indicator RBF interpolant are the same as those for an RBF interpolant. See [Using a Global Trend](#) and [Using a Structural Trend](#) in [Changing the Trend for an RBF Interpolant](#).

Adjusting Interpolation Parameters

To adjust interpolation parameters for an indicator RBF interpolant, double-click on the interpolant in the project tree, then click on the **Interpolant** tab:

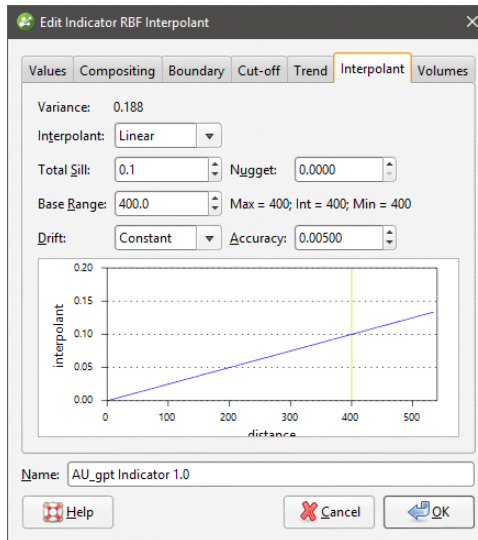

Two models are available, the spheroidal interpolant and the linear interpolant. See [The Spheroidal Interpolant Function](#) and [The Linear Interpolant Function](#) for more information on the settings in this tab.

Indicator RBF Interpolant Surfacing and Volume Options

To change the properties of the isosurface for an indicator RBF interpolant, double-click on the interpolant in the project tree, then click on the **Volumes** tab:

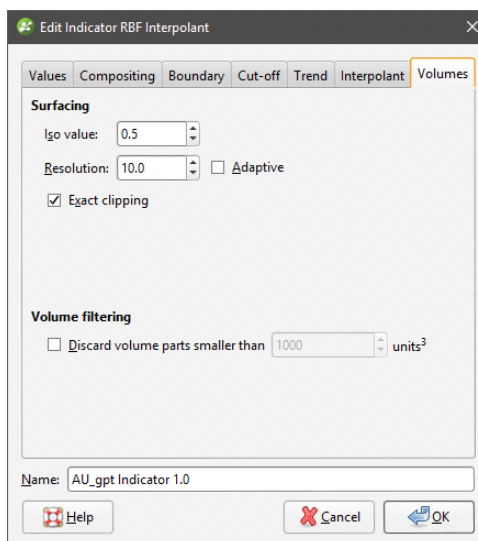

An alternative to double-clicking on the interpolant is to double-click on one of the output volumes, which opens the **Edit Indicator RBF Interpolant** window with the **Volumes** tab displayed.

The **Iso value** can be set to values from 0.1 to 0.9. Clicking the arrows changes the **Iso value** in steps of 0.1. To use a different value, enter it from the keyboard.

Setting a lower value for **Resolution** will produce more detail, but calculations can take longer. You can also set the resolution to be adaptive. See [Surface Resolution in Leapfrog Geo](#) for more information.

When **Exact clipping** is enabled, the interpolant isosurface will be generated without “tags” that overhang the interpolant boundary. This setting is enabled by default when you create an interpolant.

Use **Volume filtering** to discard smaller parts of the volumes in which you do not wish to carry out further processing. For example, this interpolant has numerous small volumes:



Enabling **Volume filtering** removes the smaller parts:

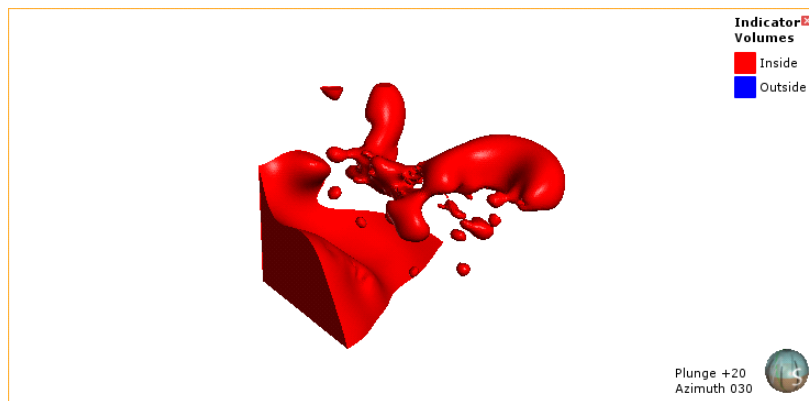

Distance Functions

A distance function calculates the distance to a set of points. This topic describes how to create and modify distance functions. It is divided into:

- [Creating a Distance Function](#)
- [The New Distance Function in the Project Tree](#)

Creating a Distance Function

To create a distance function, right-click on the **Numeric Models** folder and select **New Distance Function**. The **New Distance Function** window will be displayed:

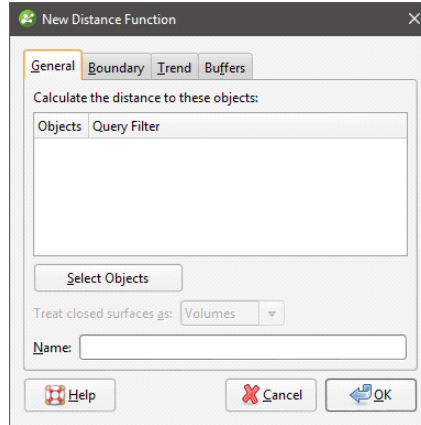

Click **Select objects** to choose from the objects available in the project. For drillholes, points, GIS points and imported GIS lines, you can apply any filter that has been defined for that object. If any of the objects selected are closed surfaces, you can choose whether these surfaces are treated as **Volumes** or as **Surfaces**.

- When treated as **Volumes**, buffers will be generated only on the outside of the mesh. If the mesh is inverted, buffers will appear on its inner surface.
- When treated as **Surfaces**, buffers will be generated on both sides of the mesh.

For example, here a distance function has been created using a sphere and one isosurface set to 100. The inner surface of the sphere is red, indicating that it is the inside of the mesh. The sphere is treated as a volume and there is a single isosurface (yellow) outside of the sphere:

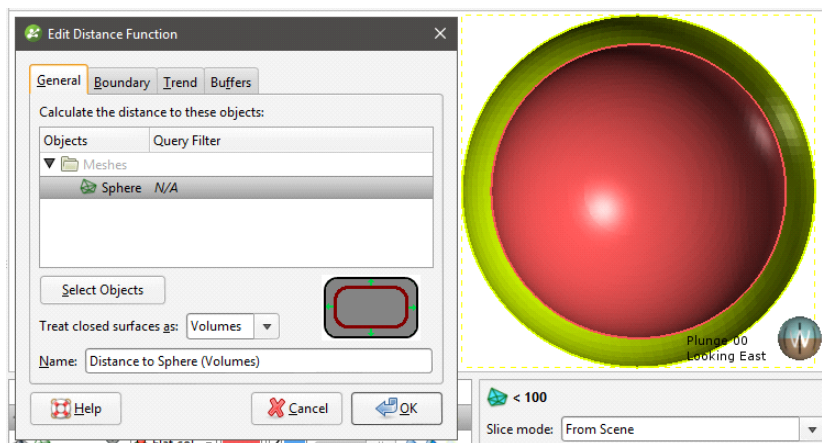

When the orientation of the sphere is reversed, the isosurface (yellow) is generated on the inner surface of the sphere:

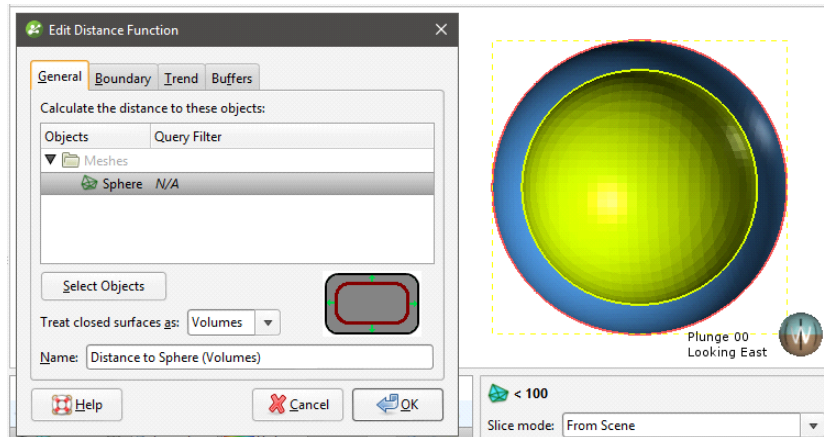

However, when the sphere is treated as a surface rather than as a volume, isosurfaces are generated on both sides of the sphere:

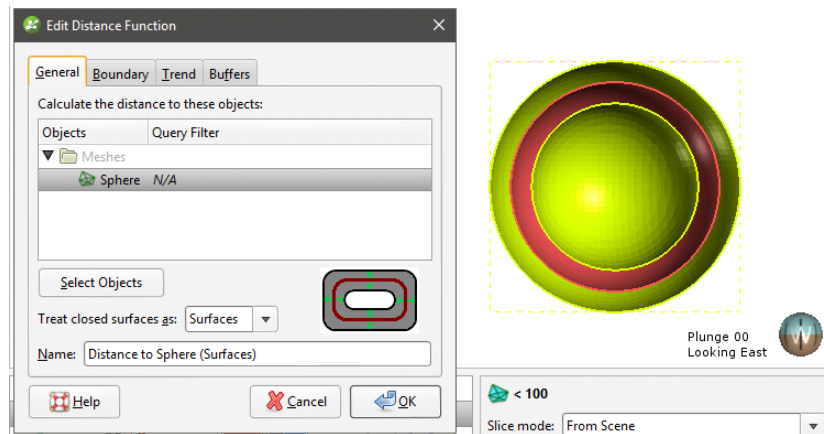

If you are unsure of some settings, most can be changed later. For a basic distance function click **Select Objects** to select from the suitable objects available in the project, then click on the **Buffers** tab to define at least one buffer so that the distance function can be visualised in the scene.

See:

- [Setting the Boundary](#)
- [Setting a Trend](#)
- [Adding Buffers](#)
- [The New Distance Function in the Project Tree](#)

Setting the Boundary

In the **Boundary** tab, you can set whether the function boundary is clipped or unclipped. **No distance buffer clipping** is the default setting, but if you choose to clip the buffers, you can choose between:

- Sharing another object's extents
- Defining a set of extents that is independent of other objects in the project.

When you select the **Shared with** option, the distance function will be updated when the extents object it shares is updated.

Setting a Trend

In the **Trend** tab, you can set a trend using the moving plane or by entering the required values. You can also use the **Set to** list to choose different options used in the project. **Isotropic** is the default option used when the function is created.

The **Ellipsoid Ratios** determine the relative shape and strength of the ellipsoids in the scene, where:

- The **Maximum** value is the relative strength in the direction of the green line on the moving plane.
- The **Intermed.** value is the relative strength in the direction perpendicular to the green line on the moving plane.
- The **Minimum** value is the relative strength in the direction orthogonal to the plane.

Adding Buffers

To add buffers, click on the **Buffers** tab, then click the **Add** button:

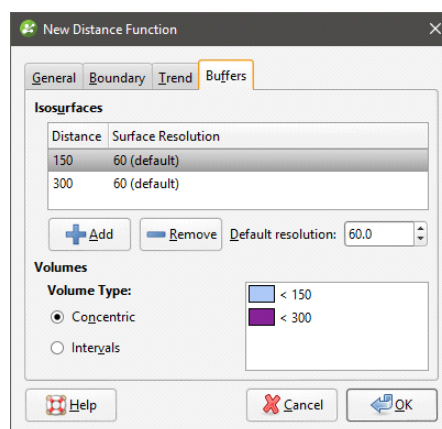

Enter the required value. To delete a buffer, click on it in the list, then click the **Remove** button. You can also change the colours used to display the buffers by clicking on the colour chips.

There are two options for **Volume Type** that affect how the buffers are calculated when more than one buffer is used. Selecting **Concentric** produces higher distance buffers that include the lower distance buffers, whereas selecting **Intervals** produces discrete, non-intersecting buffers.

The **Default resolution** setting is used for all new buffers and for existing buffers that use the default resolution.

The New Distance Function in the Project Tree

Click **OK** to create the distance function, which will be added to the **Numeric Models** folder. The new distance function contains objects representing different parts of the function, which can be expanded to show the inputs to each part of the function:

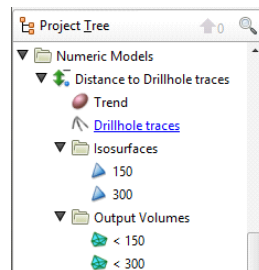

- The **Trend** object that describes the trend applied.
- Hyperlinks to objects used for the distance function.
- An **Isosurfaces** folder that contains all the meshes generated in building the distance function.
- An **Output Volumes** folder that contains all the distance buffer meshes.

Other objects may appear in the project tree under the function as you make changes to it.

Display the function by dragging it into the scene or by right-clicking on it and selecting **View Buffers**.

Once you have created a distance function, you can adjust its properties by double-clicking on it. You can also double-click on the individual objects that make up the function.

Combined Models

This topic describes creating and working with combined models. It is divided into:

- [Creating a Combined Model](#)
- [The Combined Model in the Project Tree](#)
- [Editing a Combined Model](#)
- [Displaying a Combined Model](#)
- [Creating a Static Copy of a Combined Model](#)
- [Combined Model Export](#)

A combined model uses information from up to four geological models, interpolants and distance functions in order to visualise relationships between different types of data in the project. For example, you could combine a geological model with an interpolant to see what lithologies higher grades are occurring in.

Creating a Combined Model

To create a combined model, right-click on the **Combined Models** folder in the project tree and select **New Combined Model**. In the window that appears, select the models you wish to combine, then click **OK**:

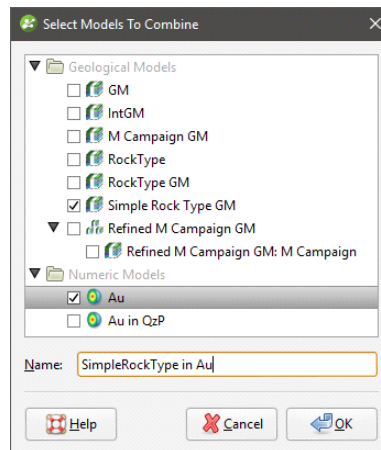

Once you have created a combined model, you cannot edit it to add new models or remove existing ones.

The next step is to select the output volumes to use in the combined model and arrange them in order of priority. For this combined model, the QzP volume from the selected geological model will be subdivided using information from the Au interpolant:

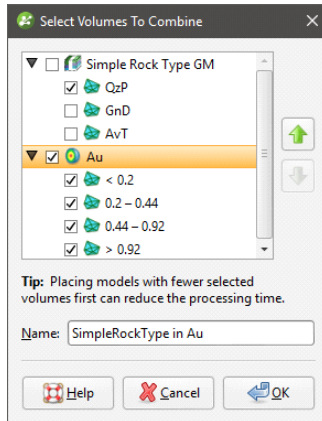

If you are using a distance buffer with concentric buffers, you will be able to select only one volume.

Click **OK** to generate the model, which will appear in the project tree in the **Combined Models** folder.

Add the model to the scene to view the results:

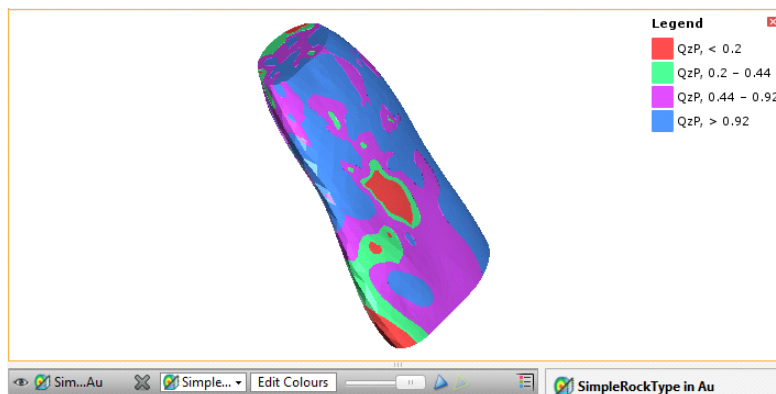

The Combined Model in the Project Tree

In the project tree, the combined model includes hyperlinks to the models used to create the combined model:

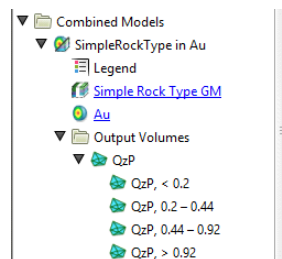

Changes made in the original models will be reflected in the combined model.

Editing a Combined Model

To change how the volumes from the source models are combined, double-click on the combined model in the project tree. Once you have created a combined model, you cannot add new models to it, nor can you remove a selected model.

Displaying a Combined Model

To change the colours used to display the model, double-click on the **Legend** object (📋). In the window that appears, click on the colour chip for each category and change it as described in [Single Colour Display](#).

To set multiple categories to a single colour, use the Shift and Ctrl keys to select the colour chips you wish to change, then click on one of the colour chips. The colour changes you make will be made to all selected categories.

Creating a Static Copy of a Combined Model

Creating a static copy preserves a snapshot of a combined model that does not change, even when changes are made to the data on which the original model was dependent. This is a useful way of storing historical models and comparing models. Static copies can be exported from Leapfrog Geo, as described in [Combined Model Export](#) below.

To create a static copy of a combined model, right-click on it in the project tree and select **Static Copy**. Enter a name for the copy of the model and click **OK**. The copy will be added to the **Combined Models** folder.

The static copy (🌐) is made up of a **Legend** object (📋) and the output volumes (🌐).

Static models created in versions of Leapfrog Geo before 2.2 copied only the output volumes and the legend, and the static model appeared in the shape list only as a single line. When these static models are upgraded and displayed in the scene, the individual output volumes will be added to the shape list.

To view the date a static copy was created, right-click on it in the project tree and select **Properties**. The date the copy was created is in the **General** tab.

Combined Model Export

There are two options for exporting a combined model's output volumes. These are:

- Export an output volume as a mesh. Right-click on it in the project tree and click **Export**. You will be prompted for a file name and location. See [Exporting a Single Mesh](#).
- Export multiple output volumes. Right-click on the combined model in the project tree and select **Export**. See [Exporting Multiple Meshes from Models](#).

Flow Models

Geological models created in Leapfrog Geo can be used as the basis for MODFLOW and FEFLOW models. You can create flow models directly in Leapfrog Geo and assign hydrological/material properties based on the lithologies in the geological model. Flow models can be exported for use in other applications, and you can import existing flow models and use them as the basis for the construction of new models. Flow models can be displayed in the scene, and time-dependent data can also be visualised.

Working with MODFLOW and FEFLOW models is available as part of the Hydrogeology module. Contact Customer Support as described in [Getting Support](#) for more information about licensing the Hydrogeology module.

If the **Hydrogeology** folder appears in the project tree as **Restricted**, you will be able to display models in the scene and change how they are displayed, but you will not be able to make changes to the models themselves.

All tools for building flow models are accessed by right-clicking on the **Hydrogeology** folder and the objects in it. Imported objects and objects created while building a flow model are also stored in the **Hydrogeology** folder, and more complex functions can be carried out by right-clicking on individual objects.

MODFLOW Models

These features are only available as part of the Hydrogeology module. See [Flow Models](#) for more information.

Once you have created a geological model, you can use it as the basis for a MODFLOW model. You can also import existing MODFLOW models and assign lithologies from a geological model.

Steps for creating a MODFLOW model that can be exported and run outside Leapfrog Geo are:

1. Create a geological model.
2. Create the MODFLOW model using the geological model to set the grid spacing and layers.
3. Evaluate the new model against a geological model, if it wasn't when it was created.
4. Edit the hydrological properties.
5. Export the MODFLOW model to MODFLOW or Groundwater Vistas.

Once the model has been processed outside of Leapfrog Geo, the model can be imported into Leapfrog Geo and visualised in the scene.

Creating MODFLOW models in Leapfrog Geo has the advantage that the resolution can be easily changed and the properties of the grid can be made to honour boundaries defined in geological models. See [Creating a MODFLOW Model](#).

See [MODFLOW Model Display](#) for information on options for displaying models in the scene.

Models created in Leapfrog Geo can be evaluated against a geological model when they are created. Models imported into Leapfrog Geo or that were not evaluated when they were created can be evaluated as described in [MODFLOW Evaluations](#).

Once a model has been defined and evaluated against a geological model, hydrological properties can be assigned and the grid can be exported. See [MODFLOW Hydrological Properties](#) and [MODFLOW Model Export](#).

Creating a MODFLOW Model

This feature is only available as part of the Hydrogeology module. See [Flow Models](#) for more information.

To create a new MODFLOW model, you must first have at least one geological model defined in the project. Once this has been defined, add the geological model to the scene. Right-click on the **Hydrogeology** folder and select **MODFLOW > New Structured Model**. The **New MODFLOW Model** window will be displayed, together with controls in the scene that will help you to set the grid extents:

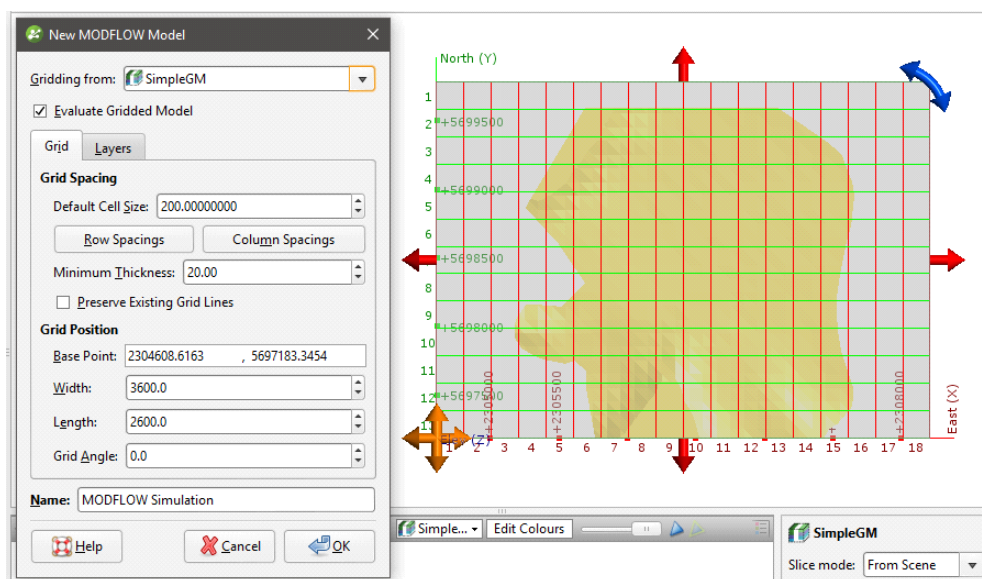

The new MODFLOW grid will be based on the geological model in the **Gridding from** setting. If you wish to use a geological model other than the one selected when the window is opened, select it from the list. The grid dimensions will be updated in the scene.

If the **Evaluate Gridded Model** box is ticked, the selected geological model will be evaluated on the new grid and set as the evaluation for export. If you do not wish to evaluate the geological model on the grid, untick the box. You will still be able to use the layers in the geological model to control the grid layers.

The **Preserve Existing Grid Lines** option is used when setting a non-uniform grid in the scene window. If you are going to define a non-uniform grid in this way, create the model with the **Default Cell Size** set to the smallest cell size you wish to use, then edit it as described in [Editing a MODFLOW Model](#).

The grid should be slightly smaller than the selected geological model. Any MODFLOW cells

that exist outside the geological model will be marked as inactive when the grid is exported to MODFLOW .

Horizontal Grid Spacing

By default, the horizontal grid for the model is uniform, with the size of each cell set by the **Default Cell Size** value. You can change the horizontal grid by editing row and column spacings. When you click on **Row Spacings** or **Column Spacings**, the **Edit Spacings** window will be displayed:

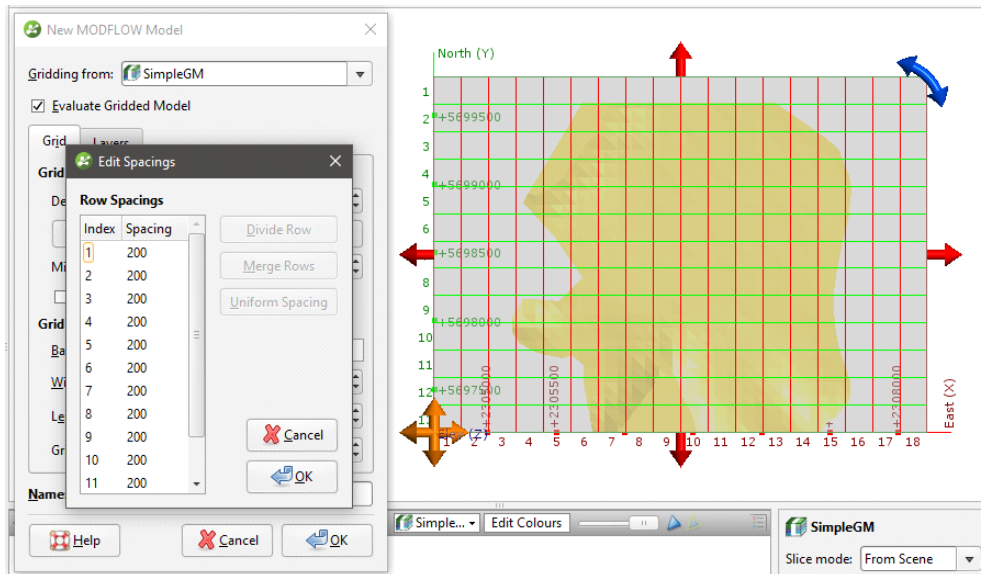

Changes made in the **Edit Spacings** window will be reflected in the scene.

There are four ways to change the spacings:

- Click on a value to edit it.
- Divide a row or column. Click on a row or column, then on the **Divide Row** or **Divide Column** button. Two new rows or columns will appear in the list.
- Merge rows or columns. Hold down the Shift key while clicking on each item, then click on the **Merge Rows** or **Merge Columns** button. The selected items will be combined.
- Set uniform spacing on selected rows or columns. You will be prompted to enter the number of cells you wish to create from the selected rows or columns.

Click **OK**.

For example, here, the rows and columns away from the model boundary have been divided to provide more detail. The different spacings are reflected in the scene:

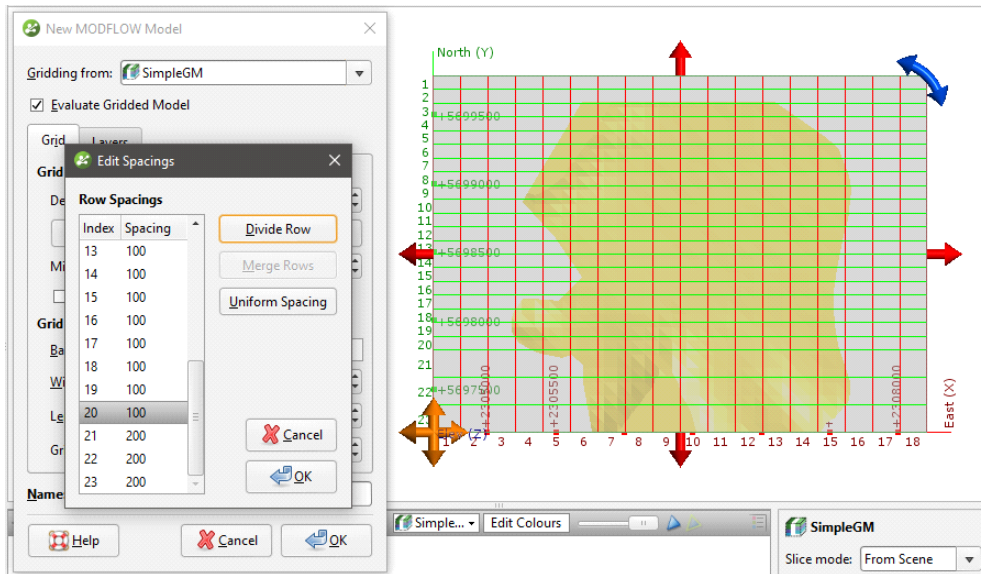

Use close spacing for steep gradients and increase or decrease spacing gradually.

Vertical Grid Layering

The vertical grid layers are based on the geological model selected in the **New MODFLOW Model** window. Click on the **Layers** tab to view the layers:

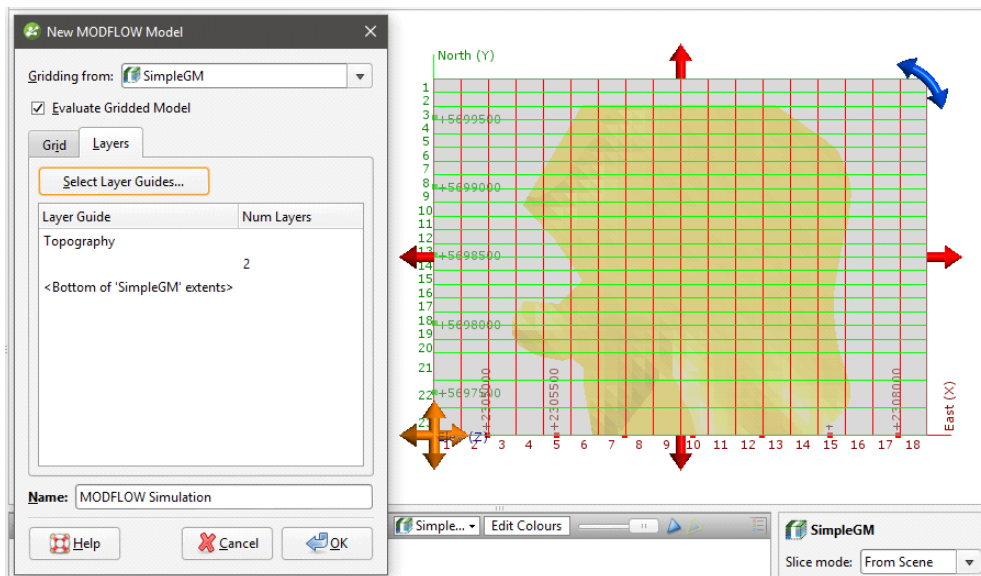

Initially, there are two layers equally spaced between the topography and the geological model. Change the layers by clicking on **Select Layer Guides** button. The **Layer Guides** window will appear, showing the layers available in the selected geological model:

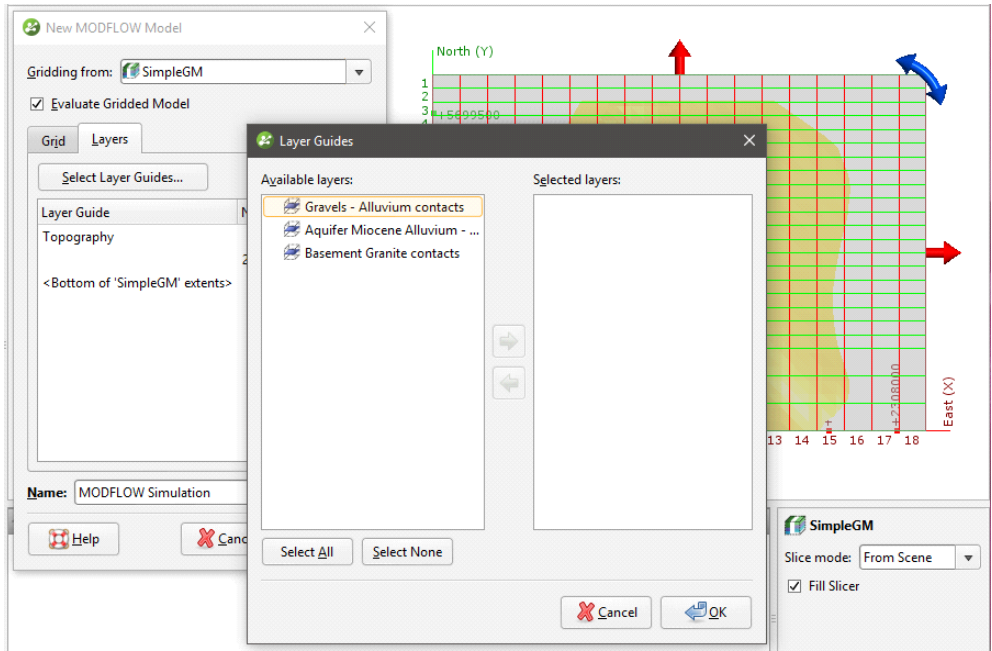

If the grid is required to follow a geological model lithology contact surface, move the layer into the **Selected** list and it will be honoured in the gridding process.

Click **OK** to return to the **New MODFLOW Model** window, in which the selected layers will be displayed:

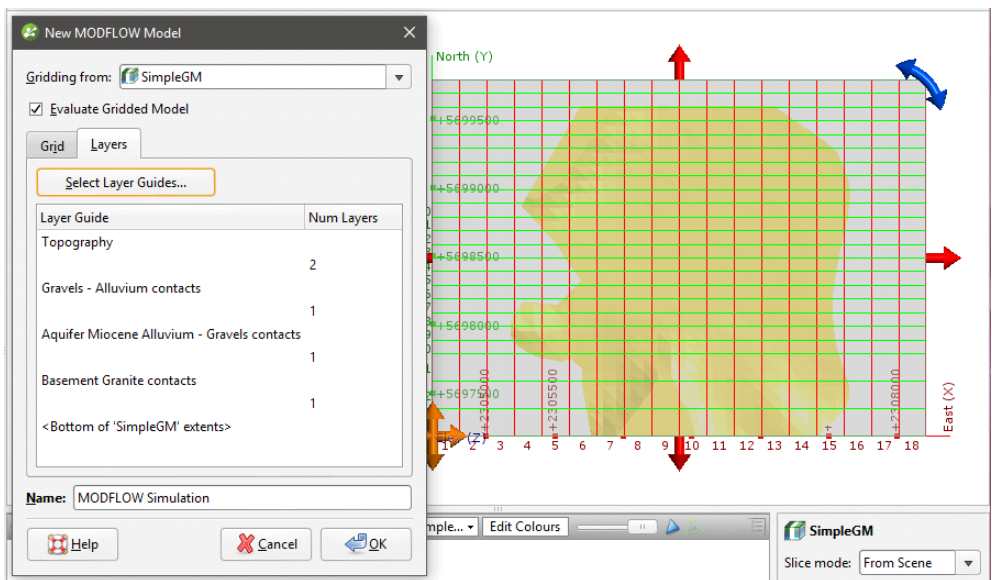

Click **OK** to create the new MODFLOW grid, which will appear in the **Hydrogeology** folder. You can edit the model by expanding it in the project tree and double-clicking on the grid object (). See [Editing a MODFLOW Model](#).

For further information on working with the new model, see:

- [MODFLOW Model Display](#)
- [MODFLOW Evaluations](#)
- [MODFLOW Hydrological Properties](#)
- [Head Values and MT3D Concentrations](#)
- [Generating a Head Value Mesh](#)
- [MODFLOW Model Export](#)

Editing a MODFLOW Model

This feature is only available as part of the Hydrogeology module. See [Flow Models](#) for more information.

Once you have created a MODFLOW model, you can edit it by expanding the model in the project tree and double-clicking on the grid object (🌐). The **Edit MODFLOW Grid** window will appear. You can edit the grid spacings as described in [Creating a MODFLOW Model](#), using the information in the scene window as a guide.

Another way to edit the grid is to use the controls in the scene to apply different cell size settings in different parts of the grid. For example, you may want to define a grid that has smaller cells in the centre than at the outer edges:

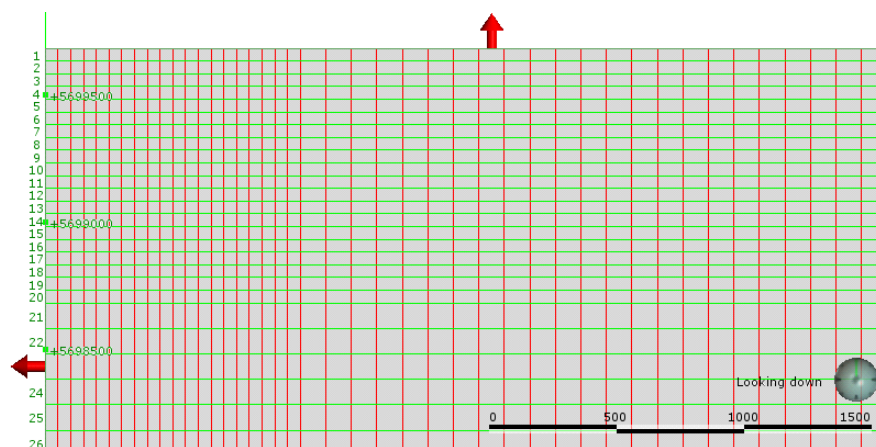

To set cell sizes in this way, it is best to start with a MODFLOW model where the **Default Cell Size** is set to the smallest cell size you will use in the model.

For this example, we will start with a new grid with a **Default Cell Size** of 50. We will set the adjacent cell size to 100 and the cell size at the outer boundary to 200.

First, we need to reduce the area that uses the cell size of 50 by using the red handles in the scene:

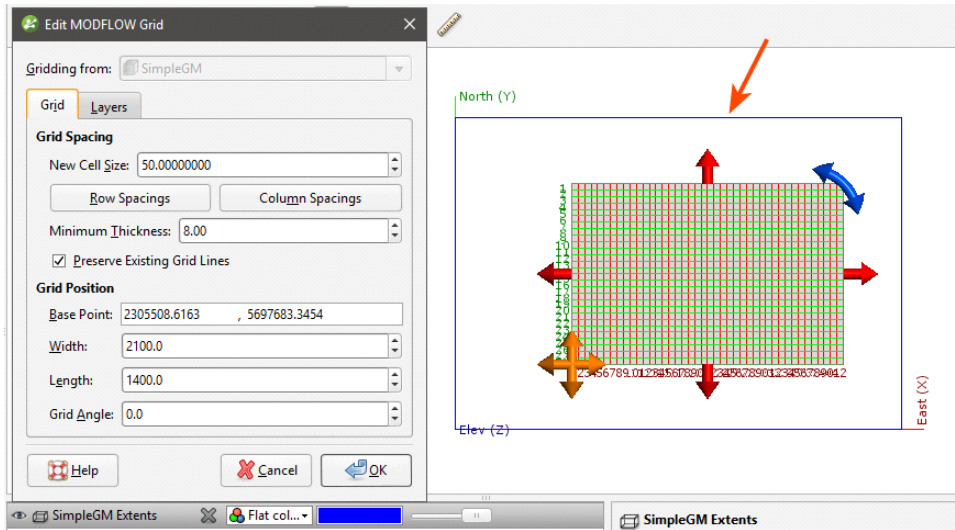

The blue box in the scene is the geological model extents for the model used to define the MODFLOW model and represents the unedited boundary of the MODFLOW model.

Next, enter the cell size to use for the area adjacent to the 50.0 cells in the **New Cell Size** field. Then, drag the red handles to enlarge the grid. The centre part of the grid is still set to 50, while the new area is set to 100:

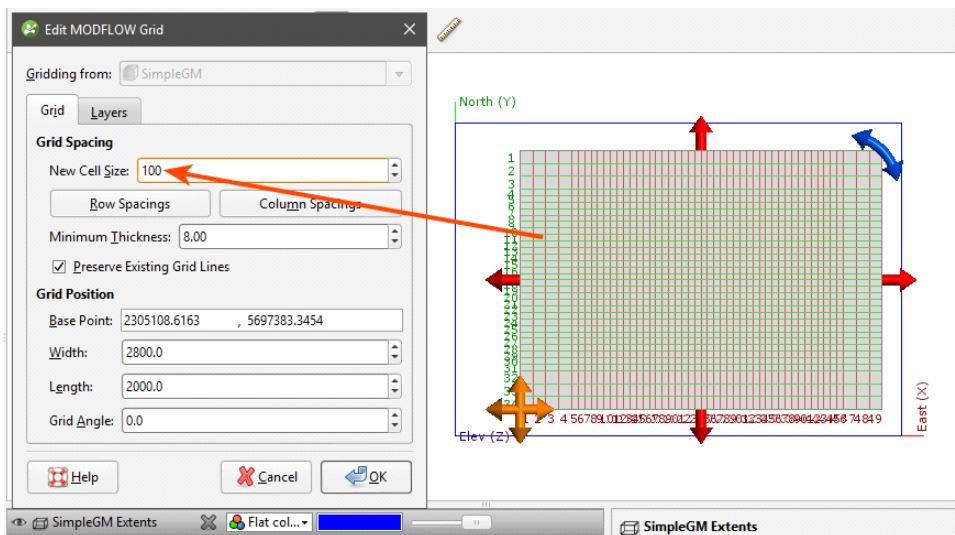

If the **Preserve Existing Grid Lines** option is enabled, grid lines for cells already defined will not be moved to account for new cells.

Enter the next cell size in the **New Cell Size** field and then use the handles to enlarge the grid again:

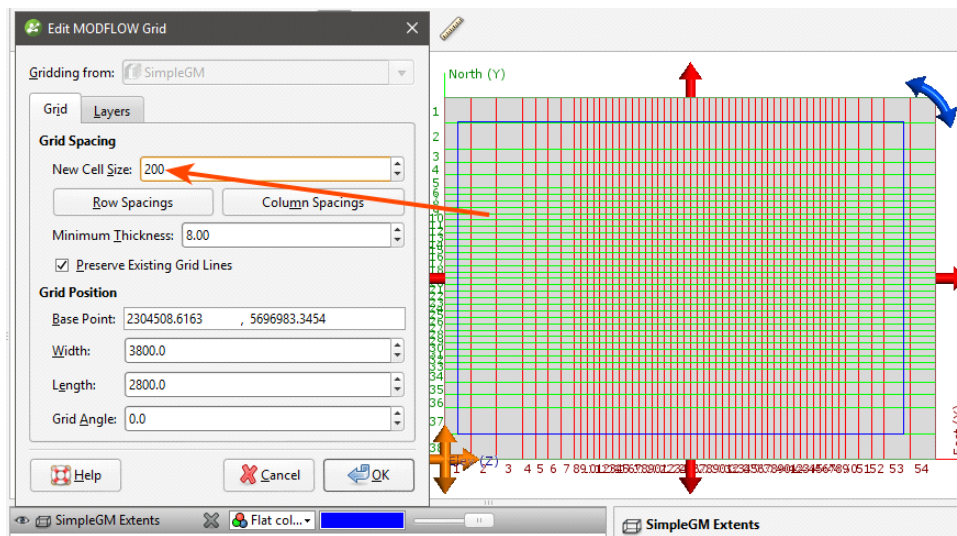

Click **OK** to update the grid.

For further information on working with the new model, see:

- [MODFLOW Model Display](#)
- [MODFLOW Evaluations](#)
- [MODFLOW Hydrological Properties](#)
- [Head Values and MT3D Concentrations](#)
- [Generating a Head Value Mesh](#)
- [MODFLOW Model Export](#)

Importing a MODFLOW Model

This feature is only available as part of the Hydrogeology module. See [Flow Models](#) for more information.

Leapfrog Geo imports .nam files and .mfi and .mfn variations of .nam files.

To import a MODFLOW model, right-click on the **Hydrogeology** folder and select **MODFLOW > Import Model**. Leapfrog Geo will ask you to specify the file location, and then will display the data in the file in the **Import MODFLOW Model** window:

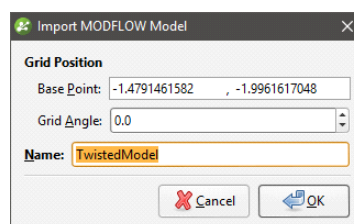

If the world origin is available, the **Grid Position** will be displayed but cannot be edited.

Click **OK** to import the grid. The new MODFLOW model will appear in the project tree in the **Hydrogeology** folder. See [MODFLOW Model Display](#) for information on displaying the model. If the world origin was not available when the model was imported, you can change the **Grid Position**. To do this, expand the imported model in the project tree and double-click on its grid object (🌐).

To associate lithologies with the grid, see [MODFLOW Evaluations](#).

MODFLOW Evaluations

This feature is only available as part of the Hydrogeology module. See [Flow Models](#) for more information.

When a MODFLOW model is exported, the evaluated geological model is used to assign lithologies to the cells in the grid. If the grid has not been evaluated against a geological model, you must do so before you can edit the hydrological properties and before you can export the grid.

To evaluate a MODFLOW model, expand the model in the project tree, then right-click on the grid object (🌐) and select **Evaluations**. Although you can evaluate an interpolant or distance function, they cannot be exported with the grid and are simply used for displaying the grid in Leapfrog Geo.

A window will appear listing all objects in the project that can be used for an evaluation. Once you have selected one or more objects, click **OK**. You will then be able to select the evaluations from the view list, as described in [Evaluations](#).

Assigning an Evaluation for Export

For MODFLOW models created in Leapfrog Geo, the evaluation used when creating the model will automatically be assigned as the evaluation for export. A hydrological properties table (📄) will appear in the project tree as part of the model.

If the model was imported into Leapfrog Geo or created without being evaluated against a geological model, you will need to manually set the evaluation for export. To do this:

- Evaluate the grid against one or more geological models, as described above.
- Right-click on the model (📄 or 📄) in the project tree and select **Set Evaluation for Export**. The **Select Evaluation** window will appear showing all geological models evaluated on the grid. Select the required evaluation and click **OK**.

A hydrological properties table will be added to the model in the project tree. Edit hydrological properties by double-clicking on the table. See [MODFLOW Hydrological Properties](#).

Combined Evaluations

You can combine geological models and set the priority used for evaluation. This is useful when you have geological models available that describe different parts of the area of interest or if you have a refined geological model for part of the model. To combine geological models for

evaluation, select the required models in the **Select Models To Evaluate** window, then click on the **Combined Evaluation** button.

In this example, there are three geological models selected:

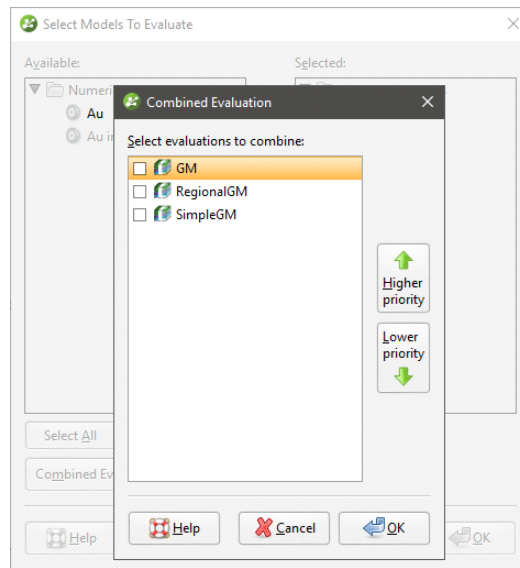

The GM and GM from contacts models describe similar areas, but GM has more detail. The GM larger model describes a larger area but with less detail. Tick the models to combine them and set their priority. Click **OK** to create the combined evaluation, then click **OK** in the **Select Models To Evaluate** window. The combined evaluation will be available from the view list and can be selected as the evaluation for export.

To delete a combined evaluation, click on the **Delete Combined** button in the **Select Models To Evaluate** window.

MODFLOW Hydrological Properties

This feature is only available as part of the Hydrogeology module. See [Flow Models](#) for more information.

When a MODFLOW model is evaluated against a geological model, a hydrological properties table (📄) is added to the model in the project tree. You can edit hydrological properties by double-clicking on the table. You can also open the table by right-clicking on the model in the project tree and selecting **Edit Hydrological Properties**.

If the model has been imported into Leapfrog Geo and has not yet been evaluated against a geological model, you will be prompted to do so. Expand the model in the project tree, right-click on the grid object and select **Evaluations**. See [MODFLOW Evaluations](#) for more information.

Hydrological properties are assigned to model blocks based on the position of the block's centroid relative to the geological model used to evaluate the grid. The position of the centroid is calculated and Leapfrog Geo then determines which lithology the centroid falls inside. The K values for the assigned lithology are assigned to the entire block; there is no averaging.

If more than one object has been evaluated on the grid, you can set hydrological properties separately for each evaluation. Select the required evaluation from the **Evaluation** list:

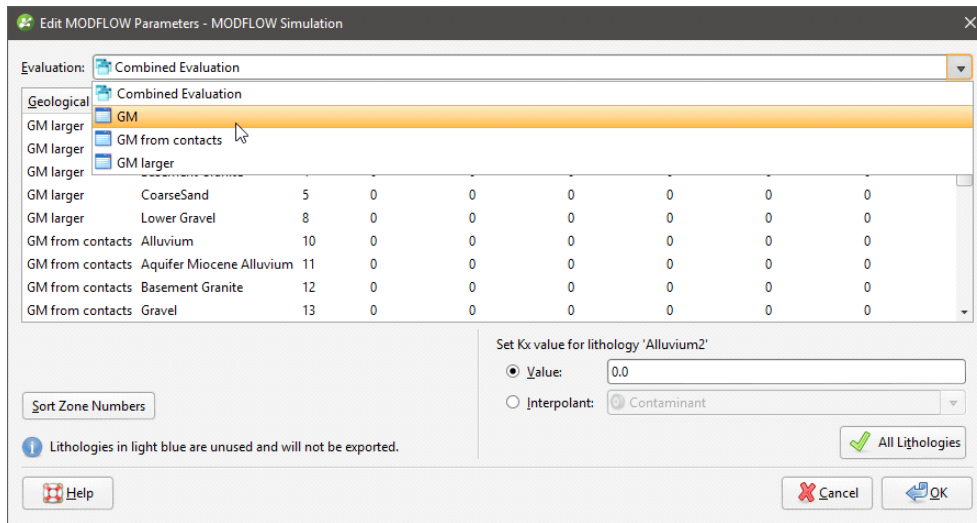

However, the only hydrological properties information that will be exported is that set for the evaluation to be exported.

Setting Hydrological Properties

In the **Edit MODFLOW Parameters** window, you can enter the values for hydrological properties manually or you can use the values from an interpolant.

To enter values manually, click on a cell, then enter the value in the **Value** field:

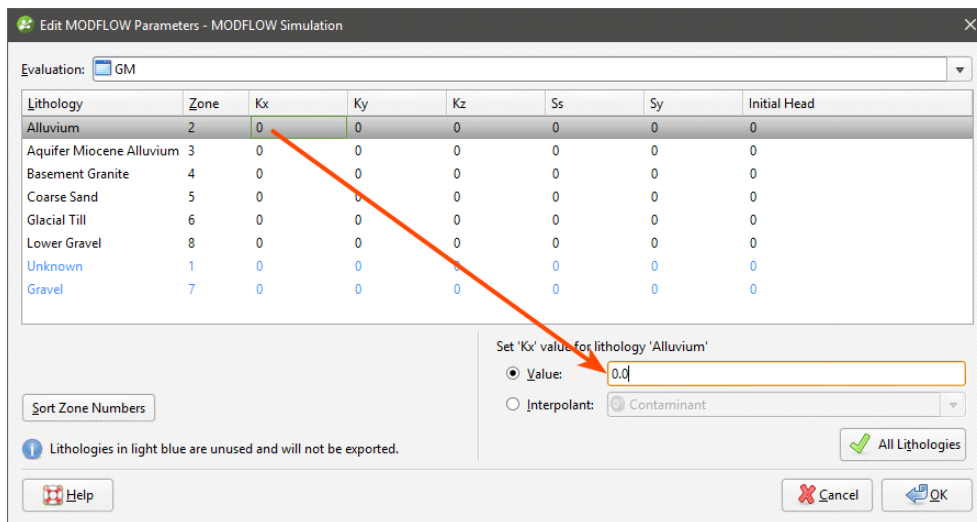

Press the Enter key to move down the columns.

To use the values from an interpolant, click the **Interpolant** button, then select an interpolant from the list. The interpolant that will be used for the selected value will be displayed in the field:

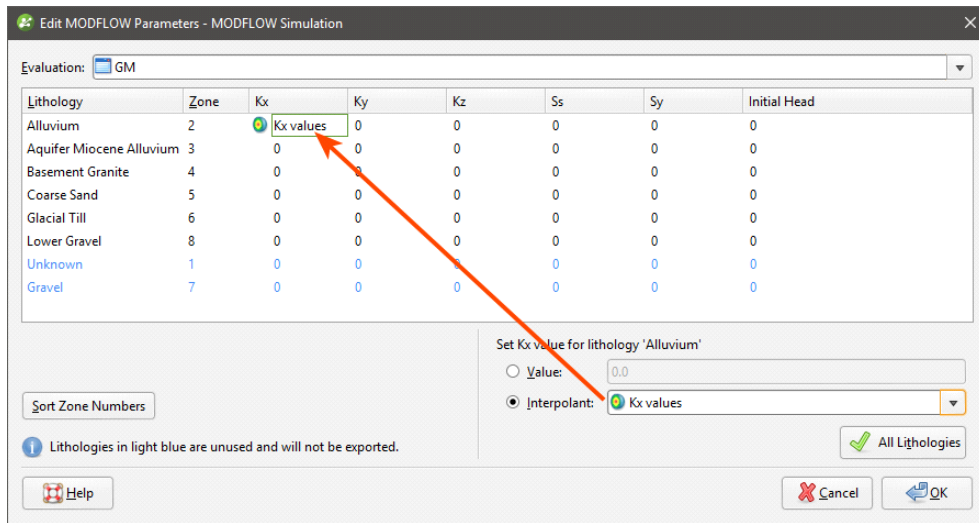

To use the interpolant for all the values in the selected column, click the **All Lithologies** button. The window will be updated to show that the interpolant values will be used for that column:

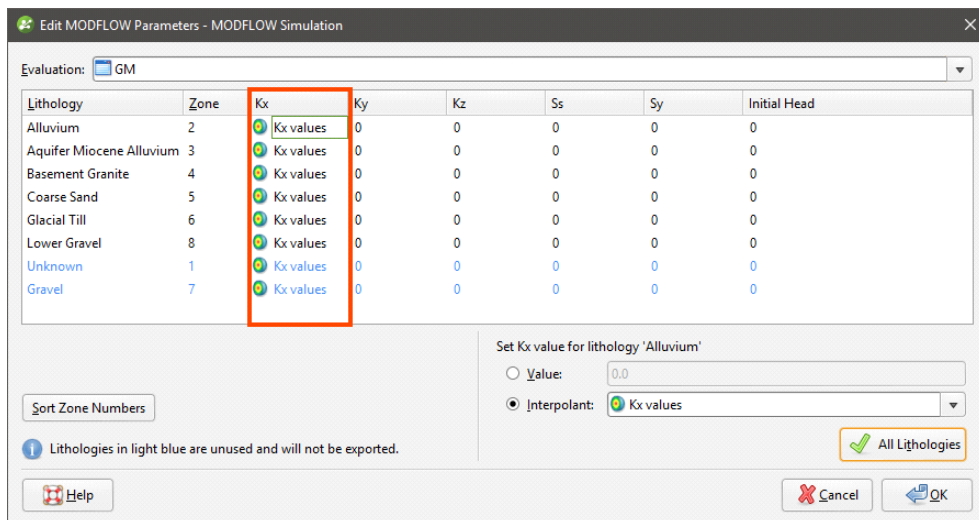

Zone Numbers

When the model is exported, the zone numbers are used to indicate the assignment of lithologies to blocks and are written to the MODFLOW zoned layer properties flow (*.lpf) file. In the **Edit MODFLOW Parameters** window, you can change the zone number for a lithology by clicking in a cell and entering a different zone number. If you reorder the zones in this way, zone number conflicts will be highlighted in red:

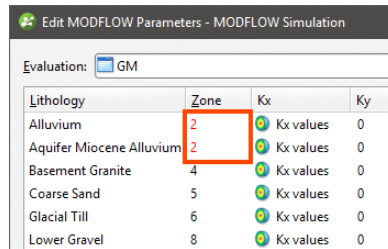

Lithology	Zone	Kx	Ky
Alluvium	2	Kx values	0
Aquifer Miocene Alluvium	2	Kx values	0
Basement Granite	4	Kx values	0
Coarse Sand	5	Kx values	0
Glacial Till	6	Kx values	0
Lower Gravel	8	Kx values	0

Zone numbers must be unique and you will not be able to close the window and save data if there are conflicts.

If you click on the **Sort Zone Numbers** button, the zone numbers will be ordered from top to bottom.

Zone numbers should not be sorted once a model has been exported as the new numbers will not be reflected in the exported model.

Click **OK** to update the grid.

MODFLOW Model Display

If you do not have a licence for the Hydrogeology module, MODFLOW models will appear in the project tree as **Restricted**. You can change how MODFLOW models are displayed, but you will not be able to make changes to the models themselves.

In the project tree, MODFLOW models are made up of a grid object (🌐), a **Simulation Outputs** folder and a hydrological properties table (📄) object. If there is no hydrological properties table, an evaluation has not yet been set for export. See [MODFLOW Evaluations](#) for more information.

For MODFLOW models created in and imported into Leapfrog Geo, dragging the model itself into the scene will display the grid (🌐) object. The different parts of the model can also be displayed.

Grid Display Options

Dragging a MODFLOW model into the scene displays its grid object. Here, an imported model has been evaluated against a geological model and added to the scene:

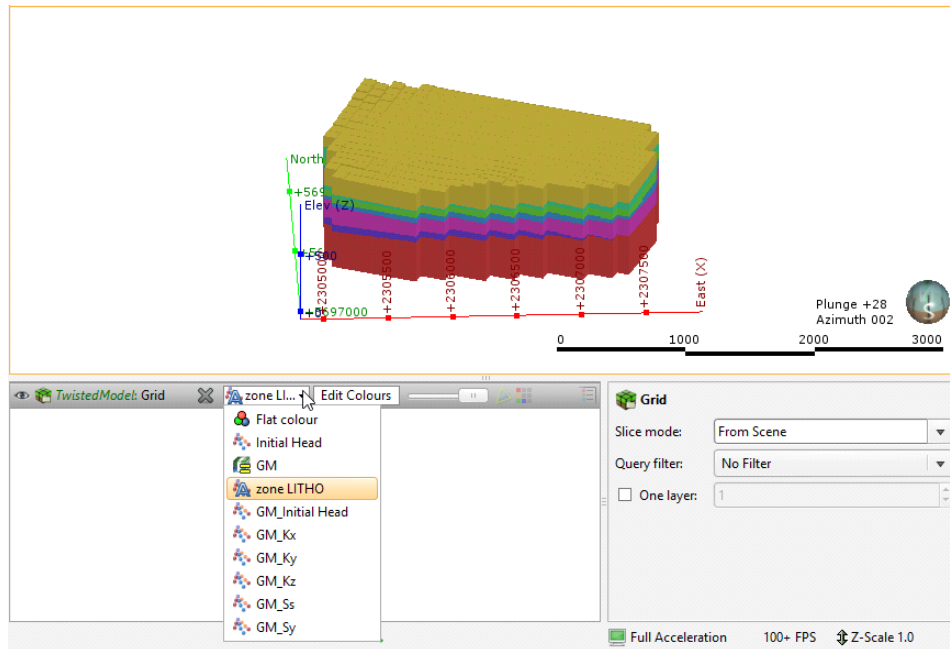

The viewing options available are the flat colour option, the evaluated geological model and zone data imported with the model. Other inputs imported with a model will also be available from this list, and once the model has been evaluated against a geological model or interpolant, you can also display the model using the grid's hydrological properties.

Grids are displayed as cells. When a geological model evaluation or lithological zone information is displayed, you can also display a legend for the grid.

When **Show edges** (🔍) is enabled, the edges of the cells will be displayed.

The **Show inactive blocks** (🔍) option displays inactive cells in grey:

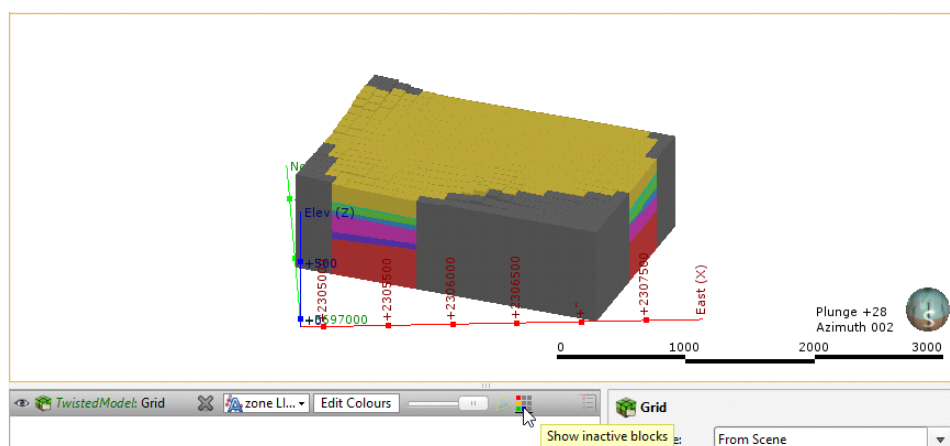

To display a single layer, tick the **One layer** box in the shape properties panel, then select the layer to display.

Head values and MT3D concentrations can also be imported and displayed. See [Head Values and MT3D Concentrations](#).

Viewing Block Information

When a MODFLOW model is displayed in the scene, you can view information about the individual cells in the model by clicking on a block. The window that appears shows information about the selected block, including its centroid and the lithology assigned to the block from the evaluated geological model. Information from all geological models and interpolants the grid has been evaluated against will be displayed:

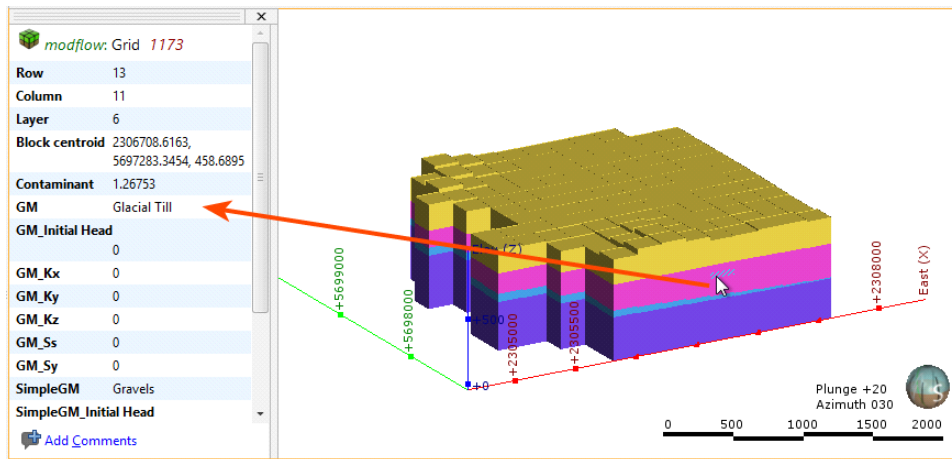

Head Values and MT3D Concentrations

This feature is only available as part of the Hydrogeology module. See [Flow Models](#) for more information.

Leapfrog Geo imports the following output file formats:

- Head values files in *.hds, *.hhd and *.hed formats
- MT3D concentrations files in *.ucn format

To import head values or MT3D concentration files for a MODFLOW model, right-click on the **Simulation Outputs** folder and select the required option. Navigate to select the file, then click **Open**.

The information will be added to the MODFLOW grid, and you can then select the head values and MT3D concentrations in the shape list when you display the grid in the scene. If the output is time-dependent, a timestep slider will be available from the shape properties panel. Click and drag the slider or click along the timeline to view the different timesteps available:

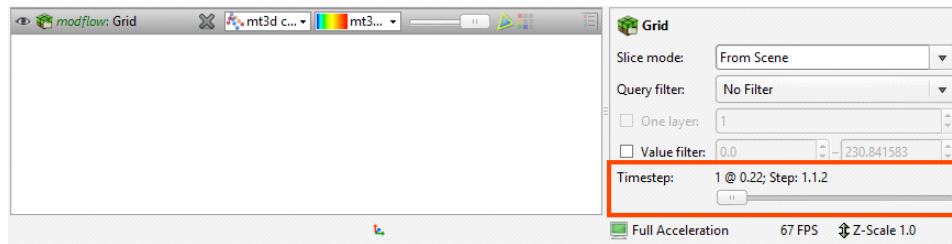

Imported head values and MT3D concentrations are stored in the project tree in the **Simulation Outputs** folder:

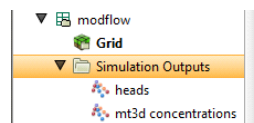

To delete head values or MT3D concentrations, right-click on the object in the project tree and select **Delete**.

Once head values have been imported, you can generate a head value mesh. See [Generating a Head Value Mesh](#).

Generating a Head Value Mesh

This feature is only available as part of the Hydrogeology module. See [Flow Models](#) for more information.

Once head values have been imported for a MODFLOW model, you can generate a head value mesh. To do this, expand the **Simulation Outputs** folder. Right-click on the head values object and select **Generate Head Value Mesh**. The **Generate Head Value Mesh** window will appear, showing the layers in the model and the timesteps available. Select the layer of the model you wish to generate a head value mesh for, then choose the heads. Click **OK** to create the mesh, which will be saved to the **Meshes** folder.

MODFLOW Model Export

This feature is only available as part of the Hydrogeology module. See [Flow Models](#) for more information.

Leapfrog Geo has three options for exporting MODFLOW grids:

- Export the grid as a MODFLOW file.
- Export for Groundwater Vistas. Use this option the first time you export a grid for use in Groundwater Vistas.

- Export a Groundwater Vistas update. Use this option to generate a set of files that can be imported into Groundwater Vistas as an update.

The Groundwater Vistas options include a zoned layer properties flow (*.lpf) file that includes information about the zones in the grid.

As a MODFLOW File

To export a grid as a MODFLOW file for use in a package other than Groundwater Vistas, right-click on the grid in the project tree and select **Export to MODFLOW**. You will be prompted to choose a **File name** and location. Select the options required, then click **Save**.

For Groundwater Vistas

To export a grid for use in Groundwater Vistas for the first time, right-click on the grid in the project tree and select **Export to MODFLOW for GWV**. You will be prompted to choose a **File name** and location. Select the options required, then click **Save**.

If you have previously exported the grid to Groundwater Vistas and have made changes to the grid, use the **Export to GWV Updates** option.

As a Groundwater Vistas Update

If you have exported a grid to Groundwater Vistas but then make changes to the Leapfrog Geo model, you can export the changes to the model. The set of files containing the changes can then be imported to Groundwater Vistas.

To export a Groundwater Vistas update, right-click on the grid in the project tree and select **Export GWV Updates**. The **Update Groundwater Vistas** window will appear listing the files that will be exported. Enter a **Base file name** to differentiate the original files from the updates. Click **Export**. The files will be saved in the specified directory.

FEFLOW Models

These features are only available as part of the Hydrogeology module. See [Flow Models](#) for more information.

In Leapfrog Geo, creating a 3D FEFLOW model requires:

- A geological model that will be used to assign lithologies to the FEFLOW model's blocks.
- A 2D grid that defines the block size, boundaries and surface features.

Steps for creating a 3D FEFLOW model that can be exported and run outside Leapfrog Geo are:

1. Create a geological model.
2. Create and refine a 2D model in Leapfrog Geo or import a FEFLOW model.
3. Create the 3D model from the 2D model or another 3D model in the project.
4. Evaluate the new 3D model against a geological model.

5. Edit the material types.
6. Export the 3D FEFLOW model.

Once the model has been processed outside of Leapfrog Geo, a results file can be saved that can be imported into Leapfrog Geo and visualised in the scene.

A 2D grid can be created in or imported into Leapfrog Geo. A 3D grid can also be used, in which case the layer information is not used in creating the 3D grid. Creating the 2D grid in Leapfrog Geo provides the most flexibility, as the block sizes can easily be changed, the boundaries modified and features added to provide finer resolution where there is more data available.

For information about creating 2D and 3D grids, see [Creating a 2D FEFLOW Model](#) and [Creating a 3D FEFLOW Model](#).

You can also import FEFLOW problem files and result files, visualise them in Leapfrog Geo and use them as the basis for new models. See [Importing a FEFLOW Grid](#).

See [FEFLOW Model Display](#) for information on options for displaying FEFLOW models in the scene.

3D grids created in Leapfrog Geo can be evaluated against a geological model when they are created. Grids imported into Leapfrog Geo or that were not evaluated when they were created can be evaluated as described in [FEFLOW Evaluations](#).

Once a model has been defined and evaluated against a geological model, material types can be assigned and the grid can be exported. See [FEFLOW Material Types](#) and [FEFLOW Model Export](#).

FEFLOW Model Display

If you do not have a licence for the Hydrogeology module, FEFLOW models will appear in the project tree as **Restricted**. You can change how FEFLOW models are displayed, but you will not be able to make changes to the models themselves.

In the project tree, 3D FEFLOW models are made up of a grid object representing the finite elements, a nodes object and a material types table (📄) object. If there is no material types table, an evaluation has not yet been set for export. See [FEFLOW Evaluations](#) for more information.

A 2D FEFLOW grid is made up of a grid object and a nodes object. Here, three types of FEFLOW models are shown expanded in the project tree:

- Feflow 3D Simulation is a 3D model created in Leapfrog Geo.
- Feflow 2D Simulation is a 2D model created in Leapfrog Geo.
- Feflow Results is an imported 3D model (DAC file).

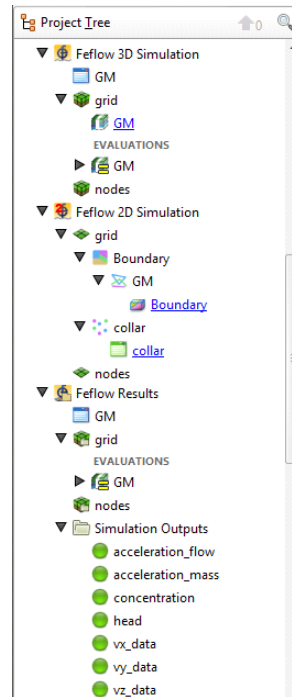

From the information in the project tree, we can see that:

- The 3D simulation created in Leapfrog Geo (📁) uses the GM geological model to define the layers.
- The 2D simulation created in Leapfrog Geo (📁) uses the GM geological model as a boundary and has had collar points added as a feature.
- The imported results model (📁) includes a number of simulation outputs.

For each type of FEFLOW model, dragging the model itself into the scene will display the grid (📁) object. The different parts of the model can also be displayed.

Displaying a 3D Model

Dragging a 3D simulation into the scene displays its grid object, which represents the finite elements. Here, a 3D model created in Leapfrog Geo (📄) has been added to the scene:

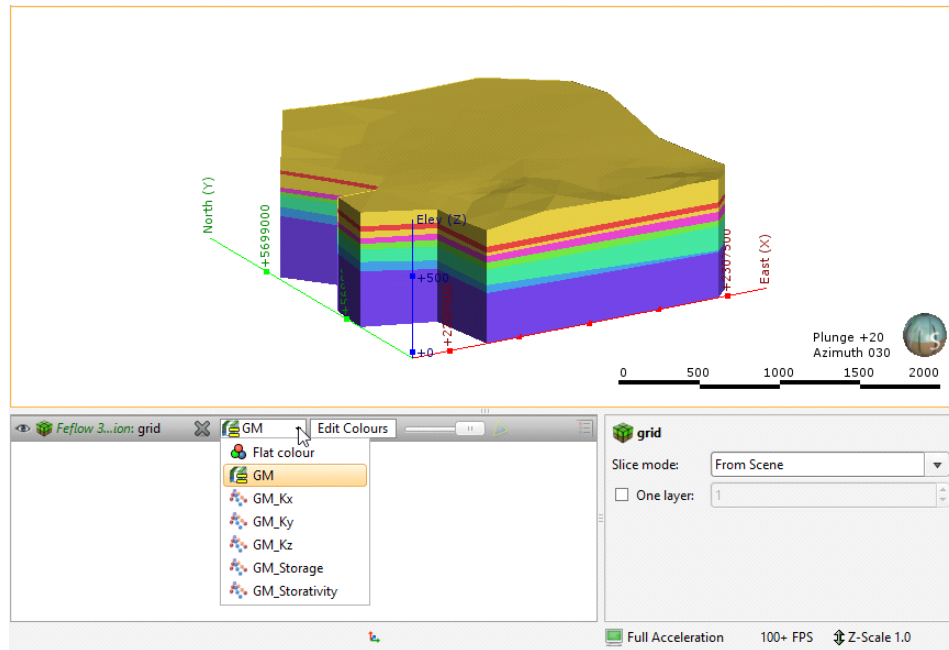

For 3D models imported into Leapfrog Geo, you can display the model using other information available for the grid, such as conductivity data. This is available from the view list.

Grids for 3D models are displayed as blocks. You can also display a legend for the grid when a geological model evaluation is displayed.

When **Show edges** (🔍) is enabled, the edges of the blocks will be displayed.

To display a single layer, tick the **One layer** box in the shape properties panel, then select the layer to display.

You can display the nodes by adding the nodes (🌐) object to the scene. When a model with results is displayed, the simulation outputs can be displayed when the nodes are viewed in the scene. Here, the nodes for an imported results file have been added to the scene. The heads are displayed for a single layer:

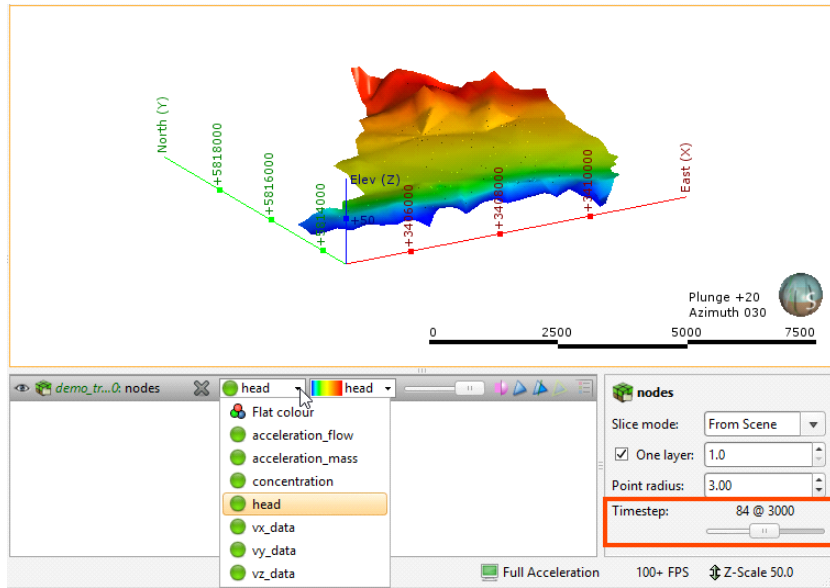

When the results are time-dependent, a timestep slider will be available from the shape properties panel. Click and drag the slider or click along the timeline to view the different timesteps available.

Displaying a 2D Model

As with 3D models, dragging a 2D model into the scene displays its grid object. Here, a 2D model created in Leapfrog Geo (🌐) has been added to the scene and viewed from above:

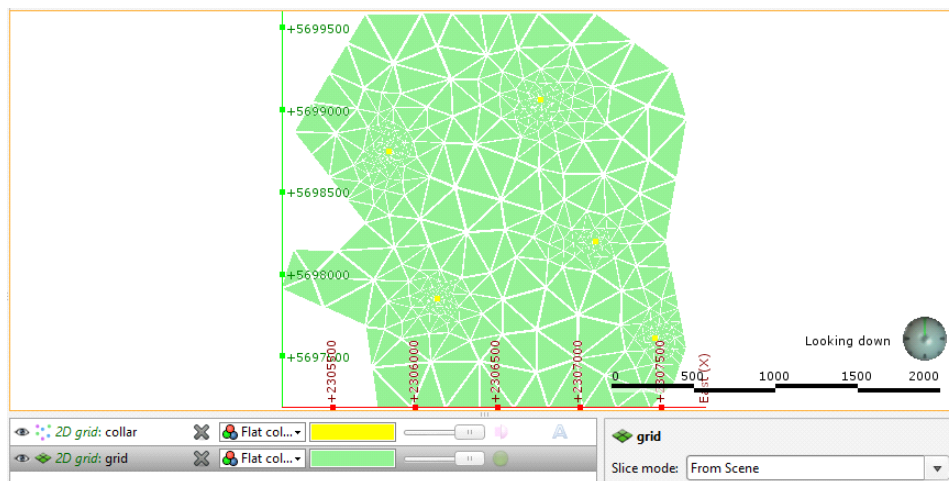

Also in the scene is a collar points object that shows collar points that have been added to the grid as a feature.

2D grids can be viewed as points or as blocks. As with imported 3D grids, an imported 2D grid can also be displayed using other information available for the grid.

Other viewing options are available for 2D grids created in Leapfrog Geo. These are useful in refining a 2D grid and are described in [Creating a 2D FEFLOW Model](#).

Viewing Block Information

When a FEFLOW model is displayed in the scene, you can view information about the individual blocks in the model by clicking on a block. The window that appears shows information about the selected block, including its centroid and the lithology assigned to the block from all evaluated geological models and interpolants:

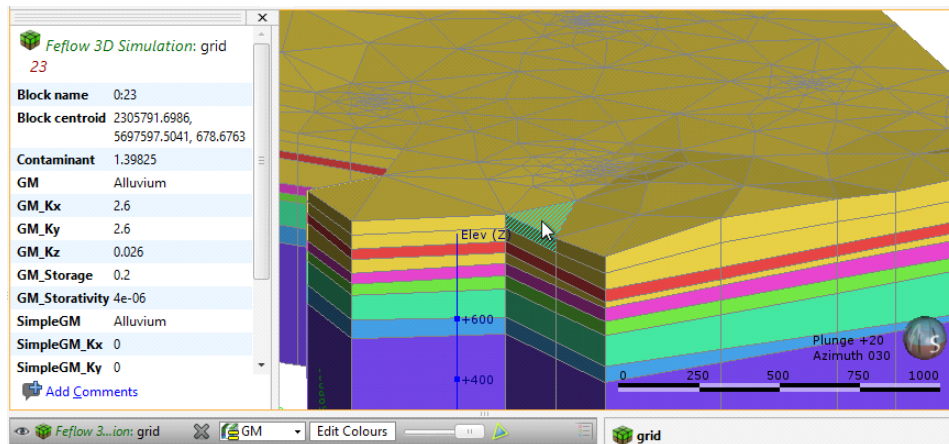

Information from all geological models and interpolants the grid has been evaluated against will be displayed:

Importing a FEFLOW Grid

This feature is only available as part of the Hydrogeology module. See [Flow Models](#) for more information.

You can import 2D and 3D FEFLOW grids and use them as the basis for new models. Leapfrog Geo imports two types of FEFLOW files:

- FEFLOW problem files (*.fem) in ASCII format. Importing these files results in a new 2D or 3D model with a grid and nodes.
- FEFLOW results files (*.dac). Importing these files results in a new 3D model with a grid, nodes and simulation outputs.

To import a FEFLOW grid or results file, right-click on the **Hydrogeology** folder and select one of the **FEFLOW > Import** options. Leapfrog Geo will ask you to specify the file location. Click **Open** to import the file.

The new FEFLOW grid will appear in the project tree under the **Hydrogeology** folder. To use the imported grid or results file as the basis for a new FEFLOW model, see [Creating a 3D FEFLOW Model](#).

To associate lithologies with a 3D grid, see [FEFLOW Material Types](#).

See [FEFLOW Model Display](#) for information about displaying the FEFLOW grid in the scene window.

Creating a 2D FEFLOW Model

This feature is only available as part of the Hydrogeology module. See [Flow Models](#) for more information.

A 2D FEFLOW model defines the block size, boundaries and surface features for a 3D FEFLOW model. Although existing 2D grids can be imported into Leapfrog Geo and used for creating 3D models, creating the 2D grid in Leapfrog Geo provides the most flexibility, as the block sizes can easily be changed, the boundaries modified and features added to provide finer resolution where there is more data available.

It is not necessary to create a geological model before creating a 2D grid. However, you will not be able to create a 3D grid until a geological model has been created. Therefore, it is a good idea to create the geological model first, and its dimensions can be used in defining the boundary of the 2D grid.

To create a 2D grid, right-click on the **Hydrogeology** folder and select **FEFLOW > New 2D Model**. The **New 2D FEFLOW Grid** window will appear:

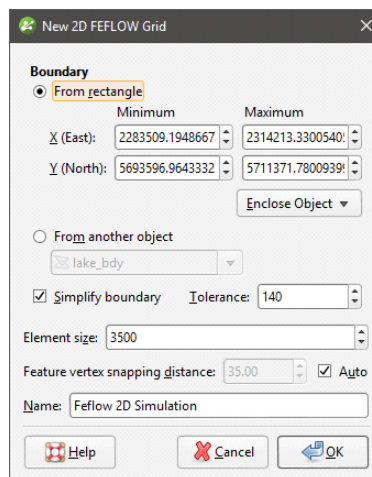

All settings can be changed once the grid has been created. It is, therefore, reasonable to accept the default settings and create the grid, then add it to the scene and begin refining it. Click **OK** to create the initial grid.

In the project tree, a 2D FEFLOW grid is made up of a grid object and a nodes object, as described in [FEFLOW Model Display](#). Here, a newly-created grid with a rectangular boundary appears in the project tree:

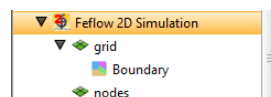

Expand the grid in the project tree and double-click on the grid object (◆) to open the **Edit 2D FEFLOW Grid** window. The **Features** tab will be displayed. When a grid is first created, this window will be empty, but once features have been added, you can enable them in this tab.

Click on the **Boundary** tab to modify the boundary:

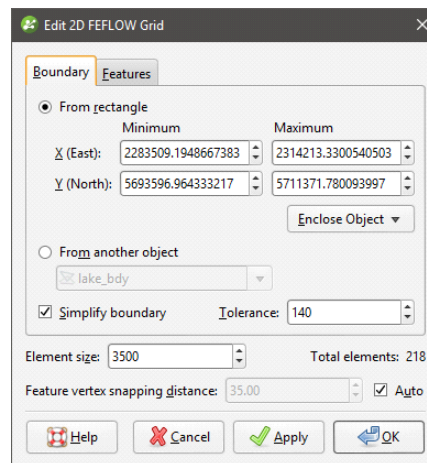

Click the **Apply** button to view the effect of changes made without closing this window.

Boundary Options

When setting the **Boundary**, you can set a rectangular boundary defined by the **From rectangle** settings. You can use the extents of any other object in the project by selecting from the **Enclose Object** list, but the grid boundary will always be a rectangle.

To define a non-rectangular boundary, use the **From another object** options and select from the list of objects available in the project. This is useful if, for example, you wish to define a grid using the boundary of a geological model.

The **Simplify boundary** option reduces the number of points along the boundary. Reducing the **Tolerance** value increases the number of points along the boundary. The two settings together let you define a basic boundary with elements that are roughly uniform in size, set by the value of **Element size**. Here, a grid has been created from a geological model with the **Simplify boundary** option enabled:

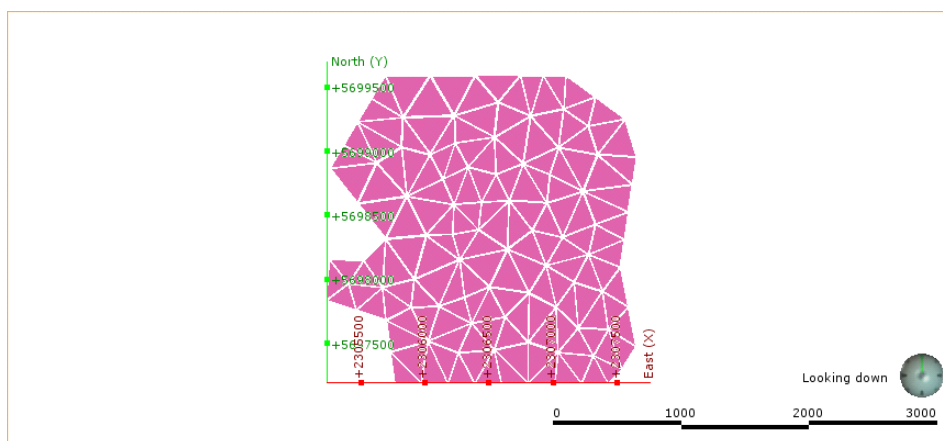

Disabling the **Simplify boundary** option results in more detail around the edges of the grid:

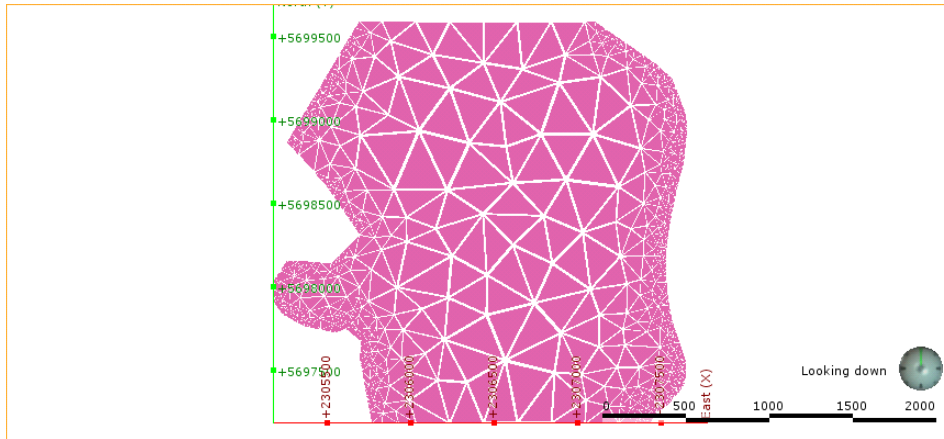

Element Size

The **Element size** setting determines the basic size of the triangles that make up the grid, although the size will vary according to features applied to the grid and the **Feature vertex snapping distance**. The size will also vary if the **Simplify boundary** option is unticked, in which case the **Element size** setting is the maximum size of the triangles.

The **Feature vertex snapping distance** is automatically set to 1 percent of the **Element size**. To use a smaller snapping distance, untick the **Auto** box and set the value required.

The effects of the **Feature vertex snapping distance** do not become apparent until features have been added to the grid.

Adding Features to the Grid

To add features to the grid, right-click on the grid in the project tree and select **New Feature**. The **New FEFLOW Feature** window will appear:

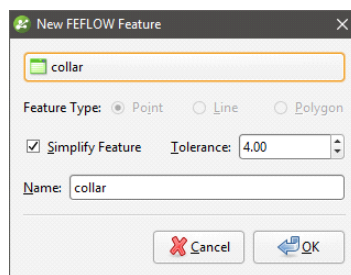

You can add **Point**, **Line** and **Polygon** features, and the **Feature Object** list will display all suitable objects available in the project. Ticking the **Simplify Feature** option will reduce the number of points used.

Click **OK** to add the feature, which will appear in the project tree under the FEFLOW grid object:

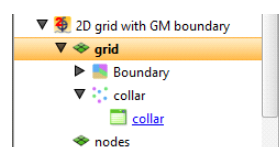

You can edit the feature by double-clicking on it or by right-clicking and selecting **Open**. However, the feature has not yet been applied to the grid. To enable the feature, double-click on the grid to open the **Edit 2D FEFLOW Grid** window. Tick the box to enable the feature, then adjust the number of **Refinement Steps**:

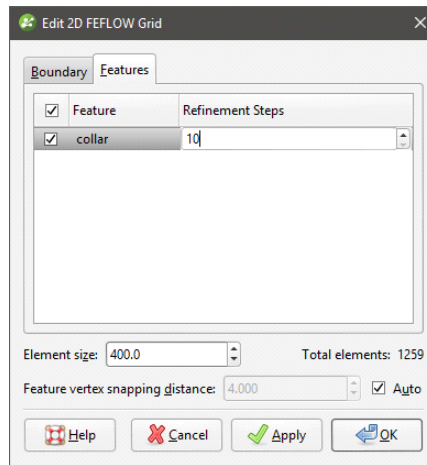

More **Refinement Steps** will produce more detail near the feature.

Click **Apply** or **OK** to view the effect the feature and its settings have on the grid.

If you want to modify a feature without having to reprocess the grid, untick it in the **Features** tab. If you want to delete a feature, right-click on it in the project tree and select **Delete**.

The images below show a grid displayed with collar points (in red) to demonstrate the effects of no features and collars applied with different refinement steps:

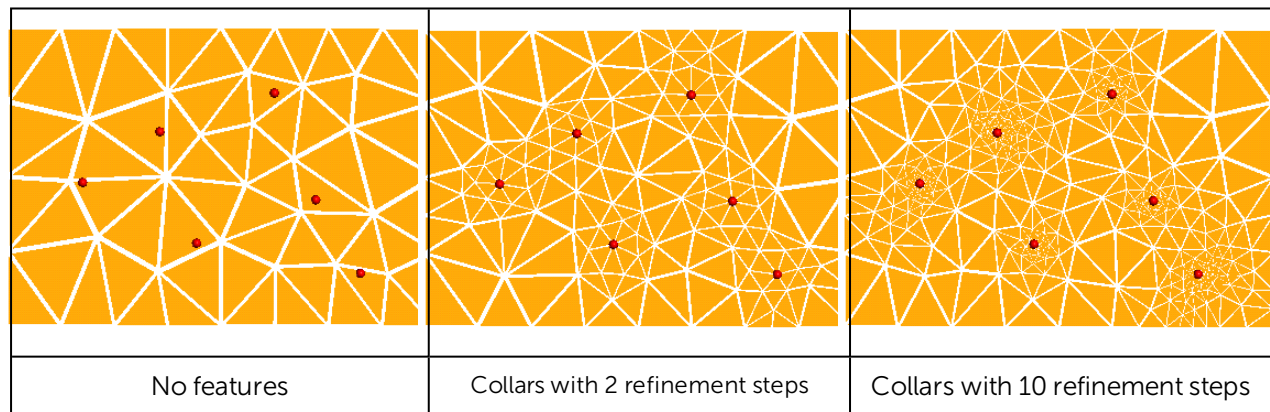

To view all features added to a grid, right-click on the grid and select **View Snapped Features**. A **Snapped Features** object will appear in the shape list that represents all objects used to add features to the grid:

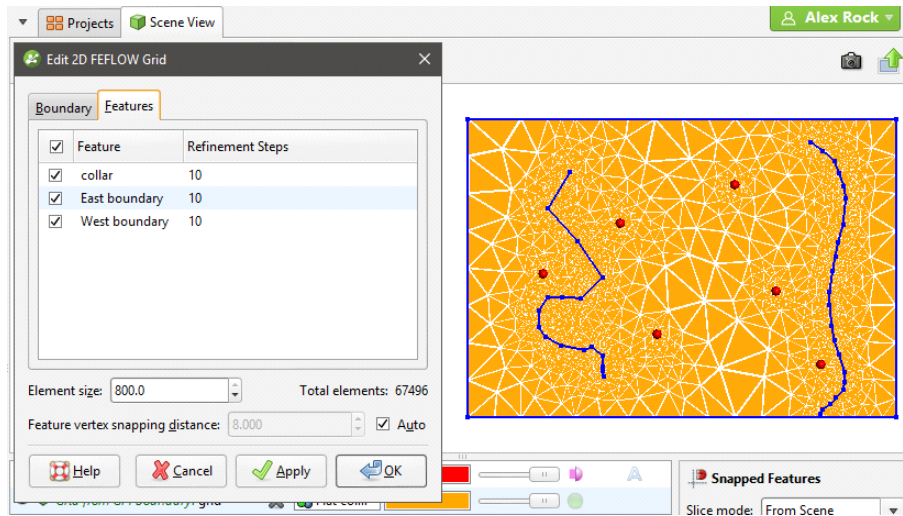

Here, four snapped objects appear in the scene: the three features listed in the **Features** tab and the grid's boundary.

See [Creating a 3D FEFLOW Model](#) for information on using the 2D grid as the basis for a 3D model.

Creating a 3D FEFLOW Model

This feature is only available as part of the Hydrogeology module. See [Flow Models](#) for more information.

To create a new 3D FEFLOW model, you must first create or import a 2D FEFLOW grid as described in [Creating a 2D FEFLOW Model](#) and [Importing a FEFLOW Grid](#).

Once you have created or imported a 2D FEFLOW grid, right-click on the **Hydrogeology** folder and select **FEFLOW > New 3D Model**. The **Extrude 3D FEFLOW Grid** window will appear:

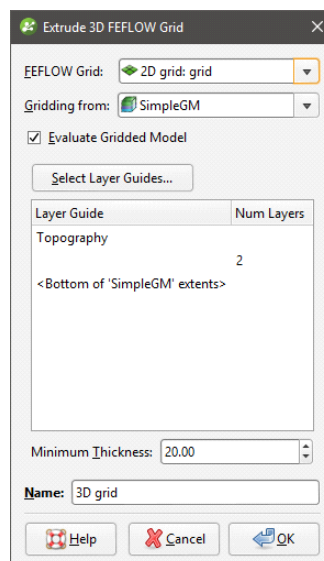

The dimensions and resolution of the grid are set by the 2D or 3D grid selected from the **FEFLOW Grid** list. See [Creating a 2D FEFLOW Model](#) for information on creating and refining a 2D grid that can be used as the basis for a 3D grid.

The **Gridding from** setting determines the geological model used for layer guides. Ticking the **Evaluate Gridded Model** box will evaluate the new 3D model against the selected geological model and set it as the evaluation for export. See [FEFLOW Evaluations](#) for more information. If you do not wish to evaluate the geological model on the grid, untick the box. You will still be able to use the layers in the geological model to control the grid layers.

The FEFLOW grid is initially made up of two layers equally spaced between the topography and the geological model, with the minimum thickness of each layer determined by the **Minimum Thickness** setting. You can add layers to the grid by clicking on the **Select Layer Guides** button and then selecting from the layers available in the geological model:

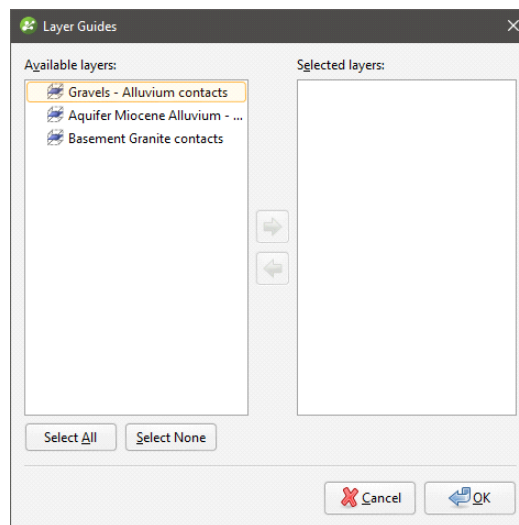

If the grid is required to follow a geological model lithology contact surface, move the layer into the **Selected** list and it will be honoured in the gridding process.

Click **OK** to return to the **Extrude 3D FEFLOW Grid** window. The selected layers will be displayed:

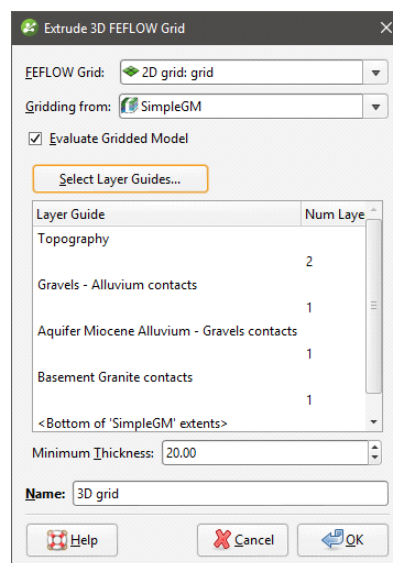

Click **OK** to generate the new FEFLOW grid, which will appear in the project tree under the **Hydrogeology** folder.

Once the model has been created, you can edit it by expanding the model in the project tree and double-clicking on its grid object. The layer guides selected, the number defined and the **Minimum Thickness** can be modified, but the FEFLOW grid on which the model is based and the geological model used for gridding cannot be changed.

The boundaries of the selected geological model must be larger than the FEFLOW grid used as the basis for the new model. If this is not the case, you can change the geological model's extents so that they enclose the FEFLOW grid.

For further information on working with the new grid, see:

- [FEFLOW Model Display](#)
- [FEFLOW Evaluations](#)
- [FEFLOW Material Types](#)
- [FEFLOW Model Export](#)

FEFLOW Evaluations

This feature is only available as part of the Hydrogeology module. See [Flow Models](#) for more information.

When a 3D FEFLOW model is exported, the evaluated geological model is used to assign lithologies to the blocks in the grid. If the grid has not been evaluated against a geological model, you must do so before you can edit the material types and before you can export the grid.

To evaluate a FEFLOW grid, expand the model in the project tree. Right-click on the grid object () and select **Evaluations**. Although you can evaluate an interpolant or distance function, they cannot be exported with the grid and are simply used for displaying the grid in Leapfrog Geo.

A window will appear listing all objects in the project that can be used for an evaluation. Once you have selected one or more objects, click **OK**. You will then be able to select the evaluations from the view list, as described in [Evaluations](#).

Assigning an Evaluation for Export

For 3D grids created in Leapfrog Geo, the evaluation used when creating the grid will automatically be assigned as the evaluation for export. A material types table () will appear in the project tree as part of the 3D grid.

If the grid was imported into Leapfrog Geo or created without being evaluated against a geological model, you will need to manually set the evaluation for export. To do this:

- Evaluate the grid against one or more geological models, as described above.

- Right-click on the model (📁 or 🗺️) in the project tree and select **Set Evaluation for Export**. The **Select Evaluation** window will appear showing all geological models evaluated on the grid. Select the required evaluation and click **OK**.

A material types table will be added to the FEFLOW grid in the project tree. Edit material types by double-clicking on the table. See [FEFLOW Material Types](#).

Combined Evaluations

You can combine geological models and set the priority used for evaluation. This is useful when you have geological models available that describe different parts of the area of interest or if you have a refined geological model for part of the model. To combine geological models for evaluation, select the required models in the **Select Models To Evaluate** window, then click on the **Combined Evaluation** button.

In this example, there are three geological models selected:

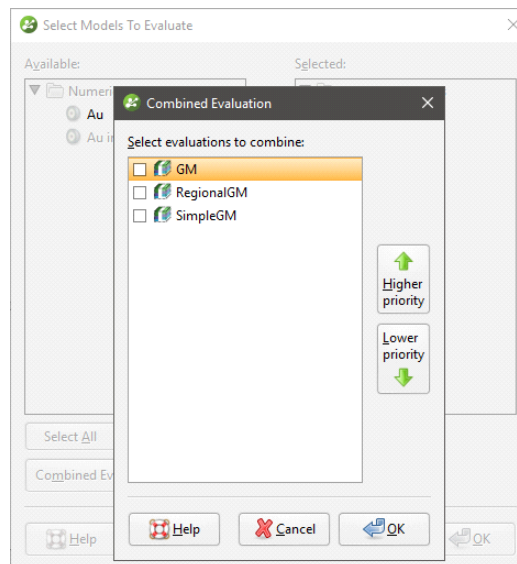

The GM and GM from contacts models describe similar areas, but GM has more detail. The GM larger model describes a larger area but with less detail. Tick the models to combine them and set their priority. Click **OK** to create the combined evaluation, then click **OK** in the **Select Models To Evaluate** window. The combined evaluation will be available from the view list and can be selected as the evaluation for export.

To delete a combined evaluation, click on the **Delete Combined** button in the **Select Models To Evaluate** window.

FEFLOW Material Types

This feature is only available as part of the Hydrogeology module. See [Flow Models](#) for more information.

When a FEFLOW model is first evaluated against a geological model, a material types table (📄) is added to the FEFLOW grid in the project tree. You can edit material types by double-clicking on

the table. You can also open the table by right-clicking on the grid and selecting **Edit Material Types**.

If the grid has been imported into Leapfrog Geo and has not yet been evaluated against a geological model, you will be prompted to do so. Expand the model in the project tree, right-click on the grid object and select **Evaluate Geological Model**. See [FEFLOW Evaluations](#) for more information.

If more than one object has been evaluated on the grid, you can set material types separately for each evaluation. Select the required evaluation from the **Evaluation** list:

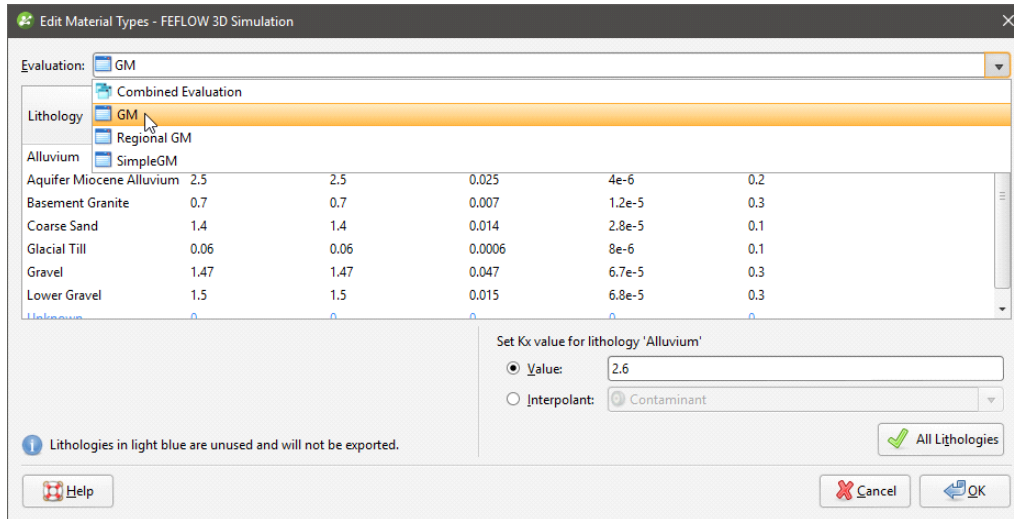

However, the only material types information that will be exported is that set for the evaluation to be exported.

In the **Edit Material Types** window, you can enter the values for material types manually or you can use the values from an interpolant.

To enter values manually, click on a cell, then enter the value in the **Value** field:

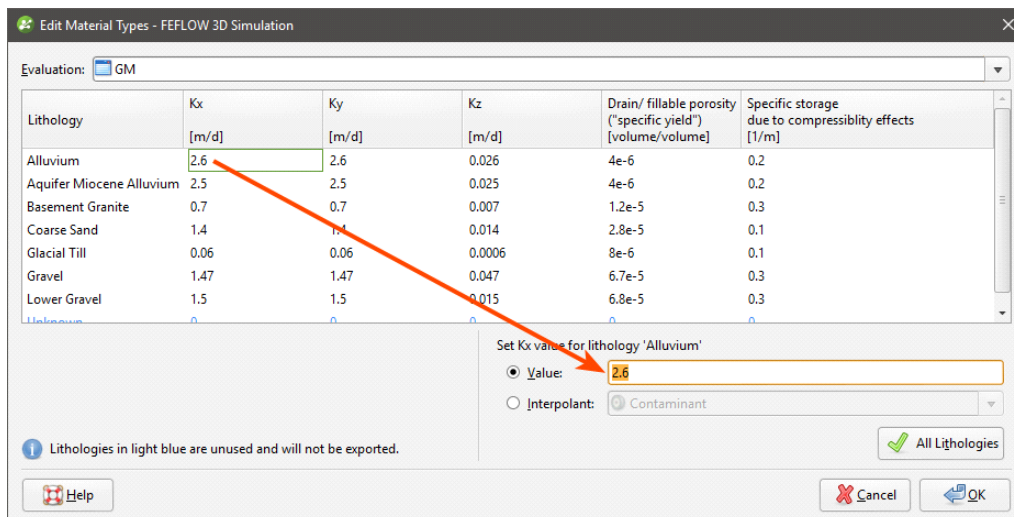

Press the Enter key to move down the columns.

To use the values from an interpolant, click the **Interpolant** button, then select an interpolant from the list. The interpolant that will be used for the selected value will be displayed in the field:

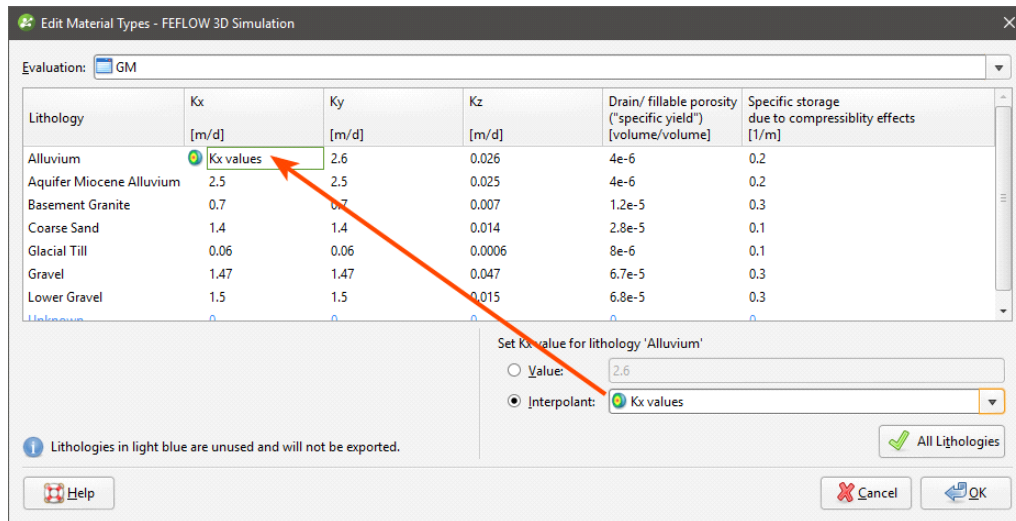

To use the interpolant for all the values in the selected column, click the **All Lithologies** button. The window will be updated to show that the interpolant values will be used for that column:

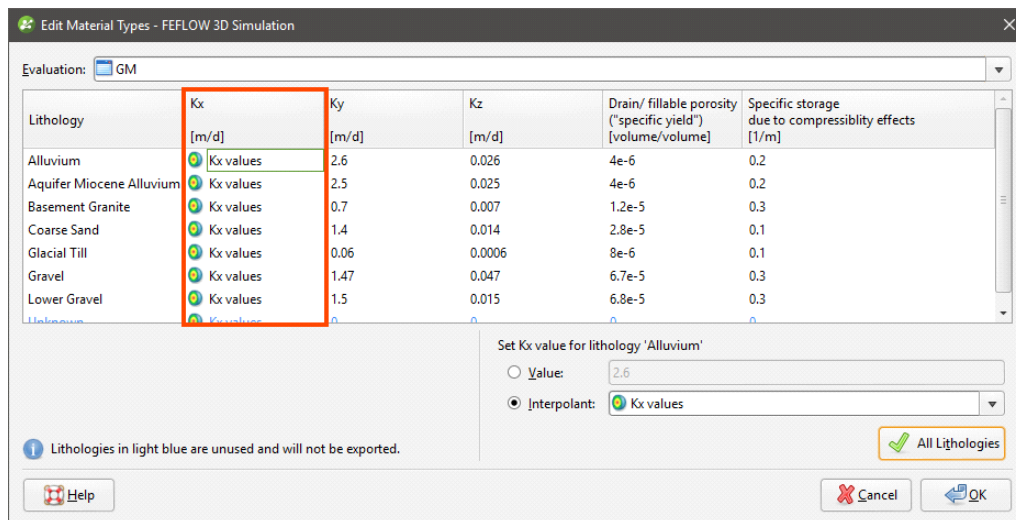

Click **OK** to update the grid.

FEFLOW Model Export

This feature is only available as part of the Hydrogeology module. See [Flow Models](#) for more information.

To export a 3D FEFLOW model as an ASCII format FEFLOW file (*.fem), right-click on the grid in the project tree and select **Export To FEFLOW**. You will be prompted to choose a **File name** and location. Select the options required, then click **Save**.

2D FEFLOW grids cannot be exported.

Block Models

The **Block Models** folder can be used to import and create block models. Model types that can be imported are:

- Isatis files
- CSV files
- UBC grids

You can also create block models and sub-blocked models, which can then be exported for use in other applications. Creating block models within Leapfrog Geo has the advantage that the resolution can easily be changed.

Block models can be evaluated against geological models and interpolants as described in [Evaluations](#). If you are licensed to use Leapfrog Edge within Leapfrog Geo, block models can also be evaluated against estimators.

The rest of this topic describes importing block models in Isatis and CSV formats, creating block models in Leapfrog Geo, viewing block model statistics and exporting block models. It is divided into:

- [Importing a Block Model](#)
- [Creating a Block Model](#)
- [Displaying a Block Model](#)
- [Viewing Block Model Statistics](#)
- [Exporting Block Models](#)

For information on working with the other type of block model, see [UBC Grids](#).

Importing a Block Model

Leapfrog Geo imports block models in the following formats:

- CSV + Text Header (*.csv, *.csv.txt)
- CSV with Embedded Header (*.csv)
- Isatis Block Model Files (*.asc)

Note that neither CSV format requires a header; once you start the import process, Leapfrog Geo will use the data in the file to locate the minimum and maximum centroids. You can view this information and change how the data is mapped before the file is saved into the project.

Importing an Isatis Block Model

To import an Isatis format block model, right-click on the **Block Models** folder and select **Import Block Model**. Select the file you wish to import and click **Open**. The model will be

imported and added to the **Block Models** folder.

Importing a Block Model in CSV Format

Block models imported in CSV format must be regular, rotated only about the Z axis. You will also need to map the data in the file to the block model format Leapfrog Geo expects.

To import a block model in CSV format, right-click on the **Block Models** folder and select **Import Block Model**. Select the file you wish to import and click **Open**. An import window will be displayed in which you can map the columns in the file to those Leapfrog Geo expects. Once you have mapped the required columns, click **Next** to define the grid.

In the next window, Leapfrog Geo uses the data in the file to check the grid definition and confirm that the centroids match:

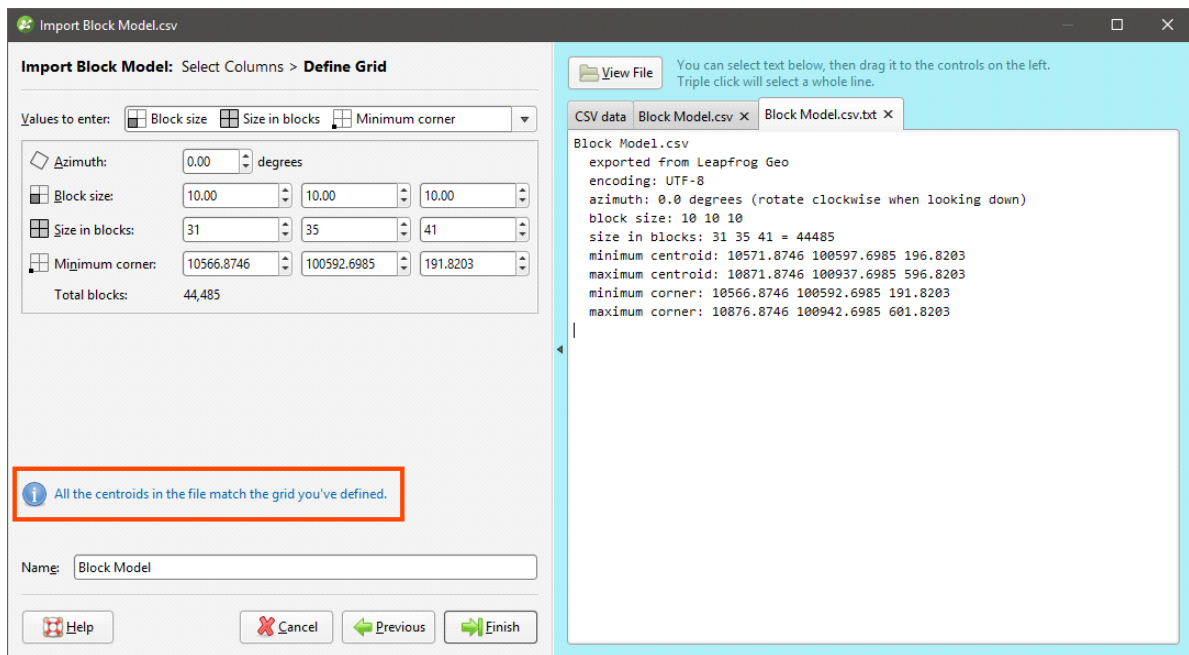

If this information is incorrect, you can select information in the file and drag it to the corresponding values on the left-hand side:

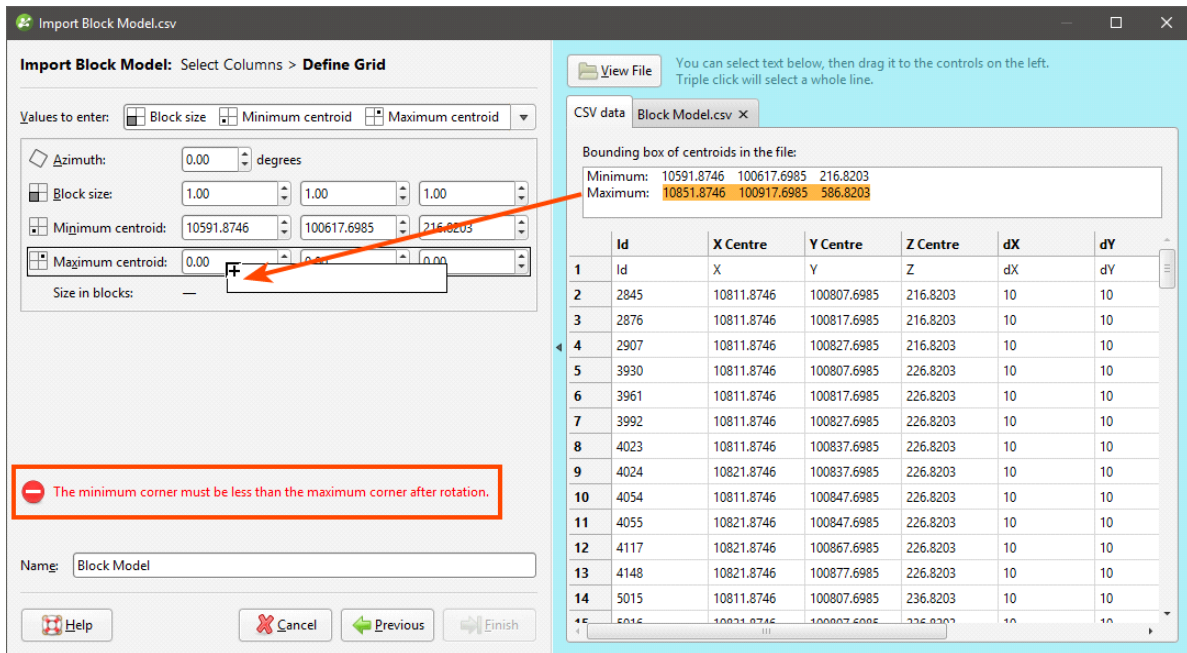

The easiest way to define the blocks is to use the **Block size**, **Minimum centroid**, **Maximum centroid** option. You can also enter the grid definition values manually.

Once Leapfrog Geo has validated the grid definition, click **Finish**. The block model will be imported and will appear in the **Block Models** folder.

Creating a Block Model

To create a new block model, right-click on the **Block Models** folder and select **New Block Model**. The **New Block Model** window will appear, together with a set of controls that will help you set the size, location and orientation of the model in the scene:

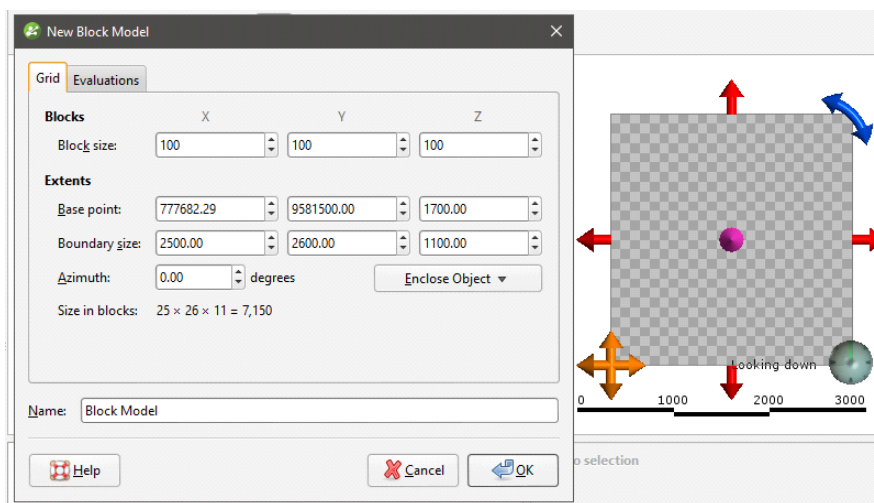

The block model is defined from its **Base point**, and the reference centroid is the **Base point** plus one half the **Block size**. Block models cannot have partial blocks, and when changes are

made to the **Block size** parameter, the model's extents will be enlarged to match the **Block size**.

If you know the values you wish to use for the model's **Extents**, enter them in **New Block Model** window. You can also:

- Use the controls in the scene to set the extents.
 - The orange handle sets the **Base point**.
 - The red handles adjusts the size of the boundary.
 - The blue handle adjusts the **Azimuth**.
- Use another object's extents. Select the object from the **Enclose Object** list.

If you wish to define a tilted block model, create a sub-blocked model with no triggers. See [Sub-Blocked Models](#).

It is a good idea to use larger values for the **Block size** as processing time for large models can be considerable. Once you have created a block model, you can change its properties to provide more detail.

You can also evaluate the block model against geological models, interpolants and distance functions in the project. To do this, click on the **Evaluations** tab. All objects available in the project will be displayed. Move the models you wish to use into the **Selected** list.

Enter a **Name** for the block model and click **OK**. The model will appear under the **Block Models** folder. You can make changes to it by double-clicking on it.

Displaying a Block Model

When a block model is displayed in the scene, there is an **Index Filter** option for displaying the grid:

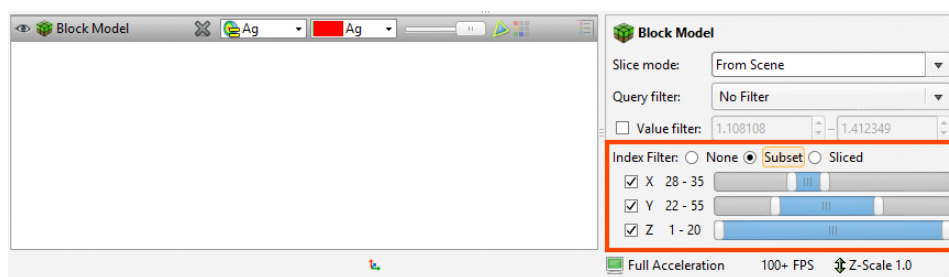

For **None**, no X, Y or Z filter is applied. For **Subset**, the grid is filtered to show the union of the selected X, Y and Z ranges. For **Sliced**, the grid is filtered to show the intersection of the selected X, Y and Z ranges.

For the **Subset** and **Sliced** options, tick the boxes for X, Y and Z. To adjust the range, drag the white handles left and right. Double-clicking on the slider alternates between displaying a single value and displaying the full range.

Viewing Block Model Statistics

To view statistics on a block model, right-click on the model in the project tree and select **Statistics**. The following options are available:

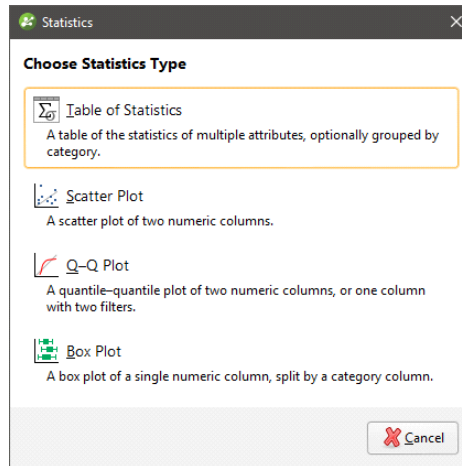

See the [Analysing Data](#) topic for more information on each option:

- [Table of Statistics](#)
- [Scatter Plots](#)
- [Q-Q Plots](#)
- [Box Plots](#)

Right-clicking a block model evaluation or a numeric calculation and selecting **Statistics** opens a univariate graph for the selection. See [Univariate Graphs](#) in the [Analysing Data](#) topic for more information.

Table of Statistics

You can view statistics for all evaluations and calculations made on a block model broken down into categories and organised by numeric evaluations and calculations. To view statistics, right-click on a block model in the project tree, select **Statistics** then select the **Table of Statistics** option.

You can view statistics for as many numeric and category columns as you wish. When you have at least one **Category column** selected, you can organise the information displayed in two ways: **Group by Category** or **Group by Numeric**. Here, statistics are displayed organised by the category data columns:

Name	Block Count	Volume	Tonnage	Mean	Std. dev.	Coeff. var.	Variance
Indicated	710	710,000.0	1,775,000.0				
Decustering	710	710,000.0	1,775,000.0	50.042	8.257	0.165	68.170
ID, Zn_pc in GM: LMS1	706	706,000.0	1,765,000.0	10.670	2.684	0.252	7.204
NN, Zn_pc in GM: LMS1	706	706,000.0	1,765,000.0	10.721	3.580	0.334	12.814
OK Kr, Zn_pc in GM: LMS1: 4x4x4	706	706,000.0	1,765,000.0	10.607	2.587	0.244	6.693
RBF, Zn_pc in GM: LMS1	710	710,000.0	1,775,000.0	9.645	3.177	0.329	10.091
Inferred	432	432,000.0	1,080,000.0				
Decustering	432	432,000.0	1,080,000.0	26.227	8.238	0.314	67.865
ID, Zn_pc in GM: LMS1	401	401,000.0	1,002,500.0	10.310	2.850	0.276	8.120
NN, Zn_pc in GM: LMS1	404	404,000.0	1,010,000.0	10.426	3.586	0.344	12.862
OK Kr, Zn_pc in GM: LMS1: 4x4x4	404	404,000.0	1,010,000.0	10.205	2.702	0.265	7.301
RBF, Zn_pc in GM: LMS1	432	432,000.0	1,080,000.0	8.202	3.077	0.375	9.468
Measured	605	605,000.0	1,512,500.0				
Decustering	605	605,000.0	1,512,500.0	105.889	37.164	0.351	1,381.135
ID, Zn_pc in GM: LMS1	605	605,000.0	1,512,500.0	12.062	2.645	0.219	6.998
NN, Zn_pc in GM: LMS1	605	605,000.0	1,512,500.0	12.099	3.449	0.285	11.898
OK Kr, Zn_pc in GM: LMS1: 4x4x4	605	605,000.0	1,512,500.0	12.019	2.567	0.214	6.590
RBF, Zn_pc in GM: LMS1	605	605,000.0	1,512,500.0	11.733	3.223	0.275	10.387

The **Query filter** option uses a related filter to constrain the data set to a selected subset.

Statistics can be unweighted, weighted by volume or weighted by tonnage. Select the option you require from the **Statistics weighting** list.

You can also set the **Density** to be a **Constant** value that you specify, or you can use the one of the columns in the table.

The **Categories** list provides category classification options. When selected, the set of statistics measures for each evaluation or numeric calculation will be shown for each category.

You can hide empty categories (those with a count of zero) and inactive rows using the options below the **Categories** list:

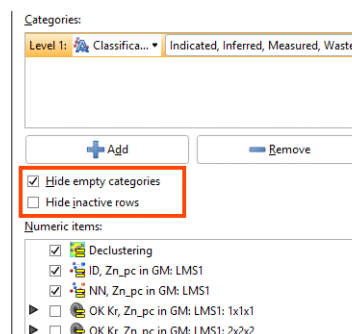

Group by category and **Group by numeric column** provide options for the table organisation.

Other controls in this window are as follows:

- The arrow buttons at the top of the window (📁 and 📂) allow you to quickly expand or collapse the rows.

- Click rows to select them.
- Select multiple rows by holding down the Shift or Ctrl key while clicking rows.
- The **Copy** button (📄) copies the selected rows to the clipboard so you can paste them into another application.

Exporting Block Models

Block models created in Leapfrog Geo can be exported in the following formats:

- CSV + Text Header (*.csv, *.csv.txt)
- CSV with Embedded Header (*.csv)
- CSV as points (*.csv)
- Isatis Block Model Files (*.asc)
- Surpac Block Model Files (*.mdl)
- Datamine Block Model Files (*.dm)

To export a block model, right-click on the block model in the project tree and select **Export**. You will be prompted to select the file format.

If you wish to export the model in one of the CSV formats, select **CSV Block Model Files (*.csv)** in the **Export Block Model** window. You will be able to choose between the three CSV formats in the next step.

Enter a name and location for the file and click **Save**. Next, you will be able to choose custom settings for the selected format.

The rest of this topic provides more information about exporting block models in CSV, Isatis, Datamine and Surpac formats.

- [Exporting Block Models in CSV Format](#)
- [Exporting Block Models in Isatis Format](#)
- [Exporting Block Models in Datamine Format](#)
- [Exporting Block Models in Surpac Format](#)

Exporting Block Models in CSV Format

The selections you make when you export a block model will be saved. This streamlines the process of subsequent exports of the model.

When you choose to export a block model in CSV format, you must first choose the type of CSV export. Options are:

- With an embedded header file. The block model definition is included at the top of the CSV file.

- With a separate text header. The block model definition is written as a separate text file.
- As points. The CSV file does not include the block sizes and model description.

Click **Next**. The steps that follow are:

- [Selecting From Evaluated Items](#)
- [Setting Row Filtering Options](#)
- [Setting Numeric Precision](#)
- [Setting Status Code Text Sequences](#)
- [Selecting the Character Set](#)

Selecting From Evaluated Items

Choose which objects will be included in the exported file. The **Available items** list includes all evaluations made onto the model. If you are licensed to use Leapfrog EDGE within Leapfrog Geo, you can also include calculations and filters, which will be exported as separate columns. The order of columns in the exported file will match the order shown in the project tree.

Click **Next**.

Setting Row Filtering Options

If you are licensed to use Leapfrog EDGE within Leapfrog Geo, you can use a **Query filter** to filter rows out of the data exported.

This is different from exporting filters as columns, as selected in the previous step.

The second option in this window is useful when all block results are consistently the same non-Normal status. Select from **Error**, **Without grade**, **Blank** or **Outside**; all rows that consistently show the selected statuses will not be included in the exported file.

Click **Next**.

Setting Numeric Precision

There are three encoding options for **Numeric Precision**:

- The **Double, floating point** option provides precision of 15 to 17 significant decimal places.
- The **Single, floating point** option provides precision of 6 to 9 significant decimal places.
- The **Custom** option lets you set a specific number of decimal places.

To change either the **Centroid and size precision** and **Column data precision** options, untick the box for **Use default precision** and select the required option.

Click **Next**.

Setting Status Code Text Sequences

When a block model is exported, non-Normal status codes can be represented in the exported file using custom text sequences.

The **Status Code** sequences are used for category status codes and filter status codes exported as columns. For filter status codes, Boolean value results will show FALSE and TRUE for Normal values or the defined **Status Codes** for non-Normal values.

Boolean values on block models are only available if you are licensed to use Leapfrog EDGE in Leapfrog Geo.

Numeric Status Codes can be represented using custom text sequences. This is optional; if no separate codes are defined for numeric items, the defined **Status Codes** will be used.

Click **Next**.

Selecting the Character Set

The selection you make will depend on the target for your exported file. You can choose a character set and see what changes will be made.

Click **Next** to view a summary of the selected options, then click **Export** to save the file.

Exporting Block Models in Isatis Format

The selections you make when you export a block model will be saved. This streamlines the process of subsequent exports of the model.

When exporting a block model in Isatis format, the steps to follow are:

- [Selecting From Evaluated Items](#)
- [Setting Status Code Text Sequences](#)
- [Selecting the Character Set](#)

Selecting From Evaluated Items

Choose which objects will be included in the exported file. The **Available items** list includes all evaluations made onto the model. If you are licensed to use Leapfrog EDGE within Leapfrog Geo, you can also include calculations and filters, which will be exported as separate columns. The order of columns in the exported file will match the order shown in the project tree.

Click **Next**.

Setting Status Code Text Sequences

When a block model is exported, non-Normal status codes can be represented in the exported file using custom text sequences.

When exporting block models in Isatis format, both category and numeric status codes can use independent custom text sequences. For filter status codes, Boolean values are exported using 0 for false and 1 for true; non-Normal values will be left blank and status codes cannot be distinguished.

Boolean Status Codes on block models are only available if you are licensed to use Leapfrog Edge in Leapfrog Geo.

Click **Next**.

Selecting the Character Set

The selection you make will depend on the target for your exported file. You can choose a character set and see what changes will be made.

Click **Next** to view a summary of the selected options, then click **Export** to save the file.

Exporting Block Models in Datamine Format

The selections you make when you export a block model will be saved. This streamlines the process of subsequent exports of the model.

When exporting a block model in Datamine format, the steps to follow are:

- [Selecting From Evaluated Items](#)
- [Setting Row Filtering Options](#)
- [Setting Status Code Text Sequences](#)
- [Selecting the Character Set](#)
- [Renaming Items](#)

Selecting From Evaluated Items

Choose which objects will be included in the exported file. The **Available items** list includes all evaluations made onto the model. If you are licensed to use Leapfrog EDGE within Leapfrog Geo, you can also include calculations and filters, which will be exported as separate columns. The order of columns in the exported file will match the order shown in the project tree.

Click **Next**.

Setting Row Filtering Options

If you are licensed to use Leapfrog EDGE within Leapfrog Geo, you can use a **Query filter** to filter rows out of the data exported.

This is different from exporting filters as columns, as selected in the previous step.

The second option in this window is useful when all block results are consistently the same non-Normal status. Select from **Error**, **Without grade**, **Blank** or **Outside**; all rows that consistently show the selected statuses will not be included in the exported file.

Click **Next**.

Setting Status Code Text Sequences

When a block model is exported, non-Normal status codes can be represented in the exported file using custom text sequences.

When exporting block models in Datamine format, both category and numeric status codes can use independent custom text sequences. Boolean values are exported using values 0 for false

and 1 for true; specify if non-Normal values should be represented by 0 or by the numeric status codes.

Boolean Status Codes on block models are only available if you are licensed to use Leapfrog Edge in Leapfrog Geo.

Click **Next**.

Selecting the Character Set

The selection you make will depend on the target for your exported file. You can choose a character set and see what changes will be made.

Click **Next**.

Renaming Items

When exporting a block model in Datamine format, column names for the evaluated objects have a maximum length of 8 characters. Leapfrog Geo will recommend truncated column names, but if you wish to use different abbreviations, click on the item's **New Name** to edit it.

Click **Next** to view a summary of the selected options, then click **Export** to save the file.

Exporting Block Models in Surpac Format

The selections you make when you export a block model will be saved. This streamlines the process of subsequent exports of the model.

When you choose to export a block model in Surpac format, you must first choose whether to export the model in Surpac version 3.2 or Surpac version 5.0. Considerations are as follows:

- Block models exported in Surpac version 5.0 cannot be imported into versions of Surpac before 5.0.
- Block models with more than 512 blocks per side can only be exported in Surpac version 5.0 format.

Choose which format you wish to use.

Click **Next**. The steps that follow are:

- [Selecting From Evaluated Items](#)
- [Setting Row Filtering Options](#)
- [Setting Numeric Precision](#)
- [Setting Status Code Text Sequences](#)
- [Selecting the Character Set](#)

Selecting From Evaluated Items

Choose which objects will be included in the exported file. The **Available items** list includes all evaluations made onto the model. If you are licensed to use Leapfrog EDGE within Leapfrog

Geo, you can also include calculations and filters, which will be exported as separate columns. The order of columns in the exported file will match the order shown in the project tree.

Click **Next**.

Setting Row Filtering Options

If you are licensed to use Leapfrog EDGE within Leapfrog Geo, you can use a **Query filter** to filter rows out of the data exported.

This is different from exporting filters as columns, as selected in the previous step.

The second option in this window is useful when all block results are consistently the same non-Normal status. Select from **Error**, **Without grade**, **Blank** or **Outside**; all rows that consistently show the selected statuses will not be included in the exported file.

Click **Next**.

Setting Numeric Precision

There are two encoding options for **Numeric Precision**:

- The **Double, floating point** option provides precision of 15 to 17 significant decimal places.
- The **Single, floating point** option provides precision of 6 to 9 significant decimal places.

To use one of these options, untick the box for **Use default precision** and select the required option.

If you are exporting the model in Surpac version 5.0, you can change the **Display precision** used for the **Double, floating point** and **Single, floating point** options.

Click **Next**.

Setting Status Code Text Sequences

When exporting block models in Surpac format, non-Normal category and numeric status codes can be represented in the exported file using custom text sequences. Status codes cannot be used for Boolean values; non-Normal values are set to false.

Click **Next**.

Selecting the Character Set

The selection you make will depend on the target for your exported file. You can choose a character set and see what changes will be made.

Click **Next** to view a summary of the selected options, then click **Export** to save the file.

Sub-Blocked Models

A sub-blocked model is a block model that is subdivided into smaller blocks where triggering surfaces intersect the blocks. Sub-blocked models can be rotated in two axes by adjusting the dip and azimuth. This topic describes creating and exporting sub-blocked models. It is divided into:

- [Creating a Sub-Blocked Model](#)
- [Sub-Blocked Model Export](#)

Creating a Sub-Blocked Model

To create a new sub-blocked model, right-click on the **Block Models** folder and select **New Sub-blocked Model**. The **New Sub-blocked Model** window will appear, together with a set of controls that will help you set the size, location and orientation of the model in the scene:

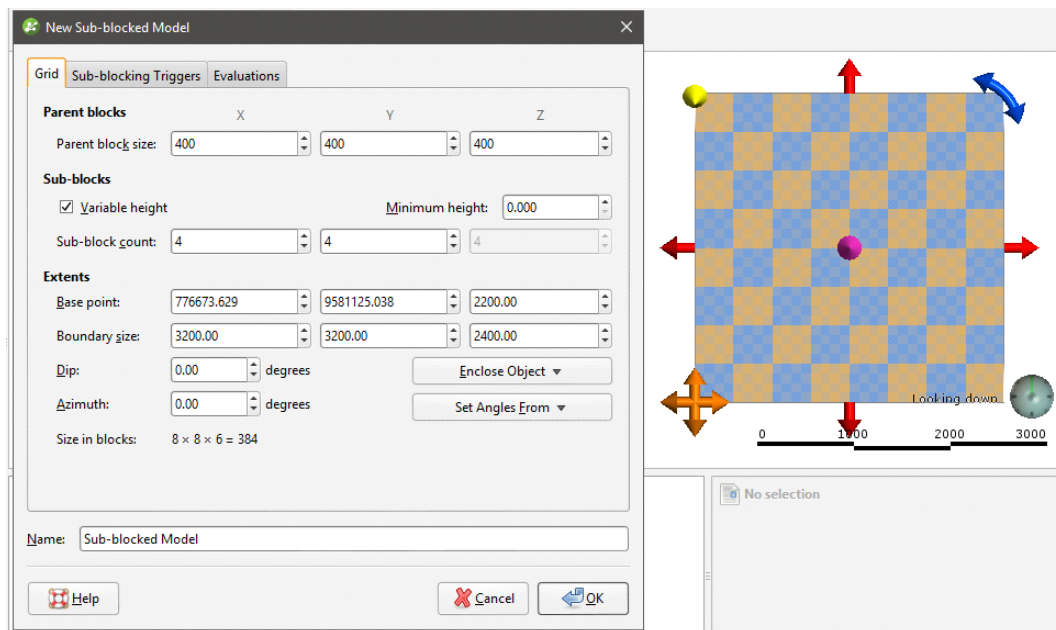

The block model is defined from its **Base point**, and the reference centroid is the **Base point** plus one half the **Block size**. Block models cannot have partial blocks, and when changes are made to the **Block size** parameter, the model's extents will be enlarged to match the **Block size**.

Model Extents and Rotation

It is a good idea to set the sub-blocked model's extents from another object in the project, selecting the required object from the **Enclose Object** list.

The **Dip** and **Azimuth** set the rotation of the model. If you know the values you wish to use, enter them in **New Sub-blocked Model** window. You can also:

- Use the controls in the scene to set the orientation. The yellow handle adjusts the **Dip** and the blue handle adjusts the **Azimuth**.
- Use either the slicer or the moving plane to set the orientation. To do this, add the slicer or the moving plane to the scene and adjust the orientation. Then select the object to use from the **Set Angles From** list.

If you have set the extents from another object and then rotated the model, you will need to reset the extents by selecting the object again from the **Enclose Object** list.

The Grid Pattern

The cross-hatched pattern shows how the parent blocks will be divided up into sub-blocks. These properties can be changed by adjusting the **Parent blocks** and **Sub-blocks** settings. The **Sub-block count** is the number of blocks each parent block is divided into when it intersects a trigger. The number of blocks in the Z axis can be:

- A variable value, based on when the parent blocks intersect triggers. Tick the **Variable height** box and set a **Minimum height**, if required.
- A fixed value. Untick the **Variable height** box and set the Z value required.

Triggers and Evaluations

Click on the **Sub-blocking Triggers** tab to select triggers from the volumes available in the project. Triggers can be:

- Geological model volumes
- Interpolant volumes
- Open meshes

All suitable objects in the project will be displayed in the **Available triggers** list.

Sub-blocked models can be evaluated against geological models, interpolants and distance functions in the project. To do this, click on the **Evaluations** tab. All objects available in the project will be displayed. Move the models you wish to use into the **Selected** list, then select the **Evaluation Type**, which can be on the sub-block centroids or on the parent block centroids.

Enter a **Name** for the sub-blocked model and click **OK**. The model will appear under the **Block Models** folder. You can make changes to it by double-clicking on it.

Sub-Blocked Model Statistics

You can view statistics for all evaluations and calculations made on a sub-blocked model broken down into categories and organised by numeric evaluations and calculations. To view summary statistics, right-click on a sub-blocked model in the project tree and select **Statistics**.

See [Viewing Block Model Statistics](#) in the [Block Models](#) topic for more information.

Sub-Blocked Model Export

Sub-blocked models created in Leapfrog Geo can be exported in the following formats:

- CSV + Text header (*.csv, *.csv.txt)
- CSV with embedded header (*.csv)
- CSV as points (*.csv)
- Datamine Block Model (*.dm)

To export a sub-blocked model, right-click on the model in the project tree and select **Export**. You will be prompted to select the file format.

If you wish to export the model in one of the CSV formats, select **CSV Block Model Files (*.csv)** in the **Export Block Model** window. You will be able to choose between the three CSV formats in the next step.

Enter a name and location for the file and click **Save**. Next, you will be able to choose custom settings for each format.

The **Export as Points** menu option available in previous versions of Leapfrog Geo has been removed. This functionality has been integrated into the **Export** menu option.

The rest of this topic provides more information about exporting sub-blocked models in CSV and Datamine formats.

- [Exporting Sub-Blocked Models in CSV Format](#)
- [Exporting Sub-Blocked Models in Datamine Format](#)

Exporting Sub-Blocked Models in CSV Format

The selections you make when you export a block model will be saved. This streamlines the process of subsequent exports of the model.

When you choose to export a sub-blocked model in CSV format, you must first choose the type of CSV export. Options are:

- With an embedded header file. The sub-blocked model definition is included at the top of the CSV file.
- With a separate text header. The sub-blocked model definition is written as a separate text file.
- As points. The CSV file does not include the block sizes and the sub-blocked model description.

Click **Next**. The steps that follow are:

- [Selecting From Evaluated Items](#)
- [Setting Row Filtering Options](#)
- [Setting Numeric Precision](#)
- [Setting Status Code Text Sequences](#)
- [Selecting the Character Set](#)

Selecting From Evaluated Items

Choose which objects will be included in the exported file. The **Available items** list includes all evaluations made onto the model. If you are licensed to use Leapfrog EDGE within Leapfrog Geo, you can also include calculations and filters, which will be exported as separate columns. The order of columns in the exported file will match the order shown in the project tree.

Click **Next**.

Setting Row Filtering Options

If you are licensed to use Leapfrog EDGE within Leapfrog Geo, you can use a **Query filter** to filter rows out of the data exported.

This is different from exporting filters as columns, as selected in the previous step.

The second option in this window is useful when all block results are consistently the same non-Normal status. Select from **Error**, **Without grade**, **Blank** or **Outside**; all rows that consistently show the selected statuses will not be included in the exported file.

Click **Next**.

Setting Numeric Precision

There are three encoding options for **Numeric Precision**:

- The **Double, floating point** option provides precision of 15 to 17 significant decimal places.
- The **Single, floating point** option provides precision of 6 to 9 significant decimal places.
- The **Custom** option lets you set a specific number of decimal places.

To change either the **Centroid and size precision** and **Column data precision** options, untick the box for **Use default precision** and select the required option.

Click **Next**.

Setting Status Code Text Sequences

When a block model is exported, non-Normal status codes can be represented in the exported file using custom text sequences.

The **Status Code** sequences are used for category status codes and filter status codes exported as columns. For filter status codes, Boolean value results will show FALSE and TRUE for Normal values or the defined **Status Codes** for non-Normal values.

Boolean values on block models are only available if you are licensed to use Leapfrog EDGE in Leapfrog Geo.

Numeric Status Codes can be represented using custom text sequences. This is optional; if no separate codes are defined for numeric items, the defined **Status Codes** will be used.

Click **Next**.

Selecting the Character Set

The selection you make will depend on the target for your exported file. You can choose a character set and see what changes will be made.

Click **Next** to view a summary of the selected options, then click **Export** to save the file.

Exporting Sub-Blocked Models in Datamine Format

The selections you make when you export a sub-blocked model will be saved. This streamlines the process of subsequent exports of the model.

When exporting a sub-blocked model in Datamine format, the steps to follow are:

- [Selecting From Evaluated Items](#)
- [Setting Row Filtering Options](#)
- [Setting Status Code Text Sequences](#)
- [Selecting the Character Set](#)
- [Renaming Items](#)

Selecting From Evaluated Items

Choose which objects will be included in the exported file. The **Available items** list includes all evaluations made onto the model. If you are licensed to use Leapfrog EDGE within Leapfrog Geo, you can also include calculations and filters, which will be exported as separate columns. The order of columns in the exported file will match the order shown in the project tree.

Click **Next**.

Setting Row Filtering Options

If you are licensed to use Leapfrog EDGE within Leapfrog Geo, you can use a **Query filter** to filter rows out of the data exported.

This is different from exporting filters as columns, as selected in the previous step.

The second option in this window is useful when all block results are consistently the same non-Normal status. Select from **Error**, **Without grade**, **Blank** or **Outside**; all rows that consistently show the selected statuses will not be included in the exported file.

Click **Next**.

Setting Status Code Text Sequences

When a sub-blocked model is exported, non-Normal status codes can be represented in the exported file using custom text sequences.

When exporting sub-blocked models in Datamine format, both category and numeric status codes can use independent custom text sequences. Boolean values are exported using values 0 for false and 1 for true; specify if non-Normal values should be represented by 0 or by the numeric status codes.

Boolean Status Codes on sub-blocked models are only available if you are licensed to use Leapfrog Edge in Leapfrog Geo.

Click **Next**.

Selecting the Character Set

The selection you make will depend on the target for your exported file. You can choose a character set and see what changes will be made.

Click **Next**.

Renaming Items

When exporting a sub-blocked model in Datamine format, column names for the evaluated objects have a maximum length of 8 characters. Leapfrog Geo will recommend truncated column names, but if you wish to use different abbreviations, click on the item's **New Name** to edit it.

Click **Next** to view a summary of the selected options, then click **Export** to save the file.

UBC Grids

Leapfrog Geo imports UBC grids in *.msh format, together with numeric values in properties files in *.gra, *.sus, *.mag and *.den formats. UBC grids can be evaluated against geological models and interpolants, which can then be exported with the grid.

Importing a UBC Grid

To import a UBC grid, right-click on the **Block Models** folder and select **Import UBC Model**. In the window that appears, click **Browse** to locate the file to be imported. Click **Add** to add any properties file, although these are not required.

For any properties file, click the **Inactive Value** field to mark cells as inactive. Doing so does not change the data but ensures that cells with the inactive value can be hidden when the grid is displayed in the scene. If you do not set this value when importing the grid, you can set it later by double-clicking on the grid in the project tree.

Click **Import**. The grid will appear in the **Block Models** folder.

Evaluating UBC Grids

UBC grids can be evaluated against geological models and interpolants as described in [Evaluations](#). However, UBC grids cannot be evaluated against fault blocks and multi-domained RBF interpolants, although they can be evaluated against the parent geological model and the parent interpolant.

Mapping Category Evaluations

When a UBC grid is exported with a category evaluation, category data is mapped to an editable numeric value. You can edit this by double-clicking on the grid in the project tree, then clicking on the **Export Mappings** tab:

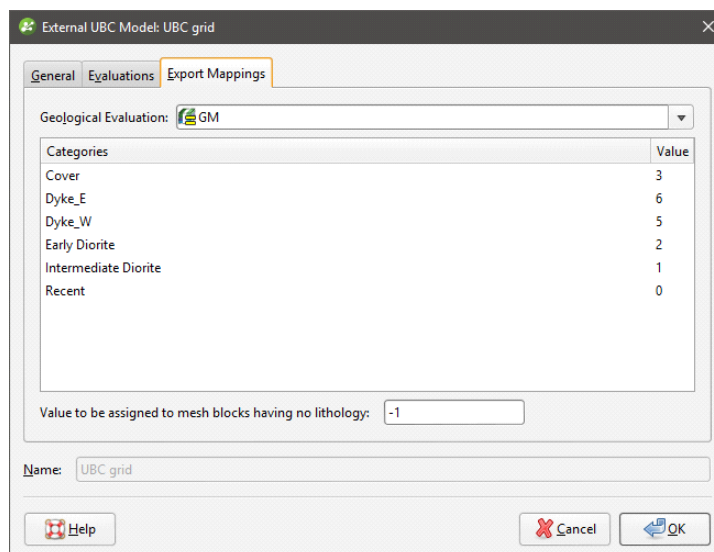

Change the numeric value assigned to each lithology, if required. You can also change the value assigned to blocks that have no lithology.

The **Export Mappings** tab does not appear for UBC grids that have no geological model evaluations.

Exporting a UBC Grid

To export a UBC grid, right-click on it in the project tree and select **Export**. Select the evaluations to export with the grid, then select a folder. Click **OK** to export the grid.

Leapfrog Edge

Leapfrog Edge features are only available if you are licensed to use Leapfrog Edge with Leapfrog Geo.

Carry out robust resource estimates in an intuitive and highly visual environment. Leapfrog Edge has the industry-standard tools you need most, arranged into a streamlined but not prescriptive workflow.

- Fully integrate your resource estimation workflow with your geological model. Refine or add data at any stage and changes flow downstream from your geological model to the resource model and everywhere in between.
- Intuitive, flexible workflows and refined, uncluttered workspaces accelerate the learning curve, improve productivity and reduce training time and frustration.
- Visualise and interact with your data throughout the resource estimation process. Iterate and see the results in 3D to gain new insights.

Best Practices

Expertise is a Prerequisite

Geological expertise and understanding are essential in estimation, and Leapfrog Geo does not dispense with this crucial element. An unskilled user can produce a model that faithfully adheres to unprocessed data but is geologically unreasonable and invalid. In the hands of an informed expert, on the other hand, Leapfrog Geo estimation tools will expedite the process of estimation and enhance the models used by the organisation.

The Geology is Fundamental

Geological modelling is the building block of an estimate, and the model needs to be geologically reasonable. A poor-quality geological model and a poor understanding of the mineralisation controls will prevent the development of a valid estimate using any process.

Analyse the Data First

Data will have errors in it that require correction. The quality of the data needs to be assessed and understood; it is important to understand how the data was collected and samples analysed. This data quality control work is essential.

Estimation specific data analysis is also required. It is important to understand the spatial relationships between the sample locations and samples and the area being studied. Tools to assist in this are described in [Data Analysis Tools](#).

Domaining

Domains are defined for stationarity, enclosing a volume where the resource can be assumed to have an expected mean value anywhere within the boundary. The domain will typically be a collection of logical units with similar mineralisation characteristics. It is important to spend time up front building geologically reasonable wireframes and mineralisation envelopes to condition the domain shapes for reasonable estimates. Defining domains to demonstrate good stationarity is important to producing good resource estimates. Domains that mix populations of mineralisation will likely result in over- or under-estimates of the metal that can be obtained from the ore.

Choose the domain to be estimated and the samples to use for estimation. Any volume in the project can be used when defining the domain, as can boundary objects and closed meshes.

The domain boundary can be defined as a hard boundary, excluding values from beyond the boundary from consideration during estimation. Or the boundary can be soft, including values up to a specified range beyond the boundary when processing the data. The selection should be made on the basis of the nature of the data, and this boundary analysis is made easier with the boundary plot that provides a visualisation of the data at and around the boundary threshold.

Variogram Hypothesis and Experimentation, Analysis

In the estimation workflow, the geologist makes a scientific hypothesis and assesses that hypothesis against the experimental data. In Leapfrog Geo, geologists make interpolants using the existing Leapfrog Geo approach, then check their estimated interpolant with traditional experimental variograms. Based on these experimental results, geologists can make adjustments to the range, nugget and other settings to make the model consistent with the experimental results, adjusting the hypothesis.

Variography tools are described in [Variogram Models](#).

Estimation Functions

Use traditional estimation methods: Nearest Neighbour, Inverse Distance, and Kriging. Additionally, use the RBF estimation method, and compare and contrast the results produced by the different methods.

The estimation functions available in Leapfrog Geo are described in [Estimators](#).

Block Modelling

Estimators can be visualised by evaluating them on block models, which is described in [Visualising Sample Geometries and Estimators](#). Calculations and filters further enhance the visualisation options, adding computational analysis and processing of data capabilities to create new types of data to visualise. Use calculations and filters to derive a new column of data from other data, including estimator function results, or define a filter to select particular information out of the data. See [Calculations and Filters on Block Models](#).

Data Analysis Tools

The first step in the process of resource estimation is gaining a thorough understanding of your data. Leapfrog Geo has general tools that help you understand your data, which are described in [Analysing Data](#). These tools help you become familiar with your data, identify possible errors and identify or confirm different mineralisation populations.

It is also important to define how invalid values in assay data are handled, which is described in the [Handling Special Values](#) topic.

The Ellipsoid Widget

The features described in this topic are only available if you are licensed to use Leapfrog Edge with Leapfrog Geo.

With variograms, you can display the ellipsoid in the 3D scene in order to:

- Visualise the variogram model in the scene
- Set variogram rotation and ranges
- Define search neighbourhoods

The ellipsoid has handles for changing the orientation, and if you have the **Variogram Model** window displayed alongside the scene window, you will see the settings in the **Variogram Model** window change as you change the ellipsoid in the scene.

The ellipsoid widget only has handles when it is in editing mode. If you drag the variogram model into the scene from the project tree, it is in view mode only. Open the variogram model by double clicking on the model in the project tree; the variogram model tab/window will open. If you switch back to the scene, you will see the ellipsoid widget in editing mode with drag handles.

Click on the widget to toggle between control modes. Each mode offers different handles for directly manipulating the ellipsoid widget. When the arrows on the edge of the widget are yellow, blue and red, the handles adjust the ellipsoid trend.

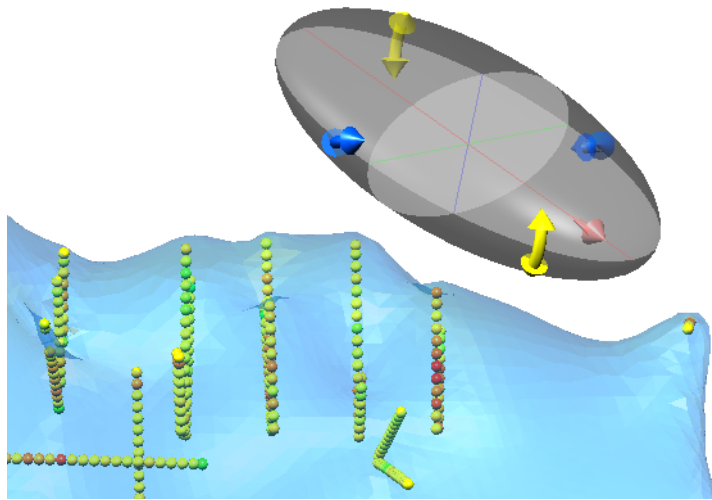

Drag a yellow arrow handle to adjust the **Dip**, blue to adjust the **Dip Azimuth** and red to adjust the **Pitch**.

When the arrows on the edge of the widget are red, green and blue, the handles adjust the ellipsoid ranges.

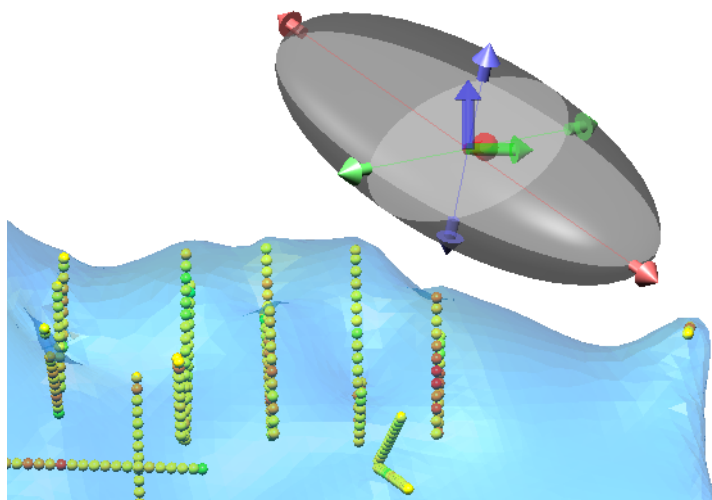

Drag a red arrow handle to adjust the **Max** axis range, green to adjust the **Int** range and blue to adjust the **Min** range.

If you click on the widget and the outer arrows do not change, you probably have a variogram model with a second structure defined. Once the second structure is defined, the structure that is controlled by the arrows would be ambiguous, which is why the range arrows are disabled for multiple structure variograms.

In the properties panel for the variogram model trend, settings control the **Centre Point** of the ellipsoid widget. The **X**, **Y** and **Z** position can be specified directly.

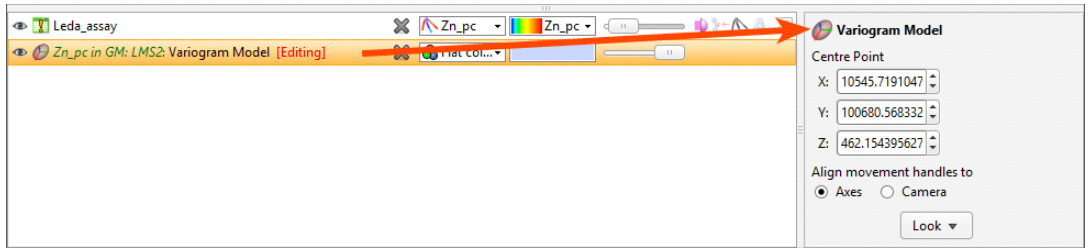

It is also possible to drag the ellipsoid to a different location. If the ellipsoid does not have arrows in the centre, click the ellipsoid so that the movement arrows appear. You can click the ellipsoid again to turn them off. Click and drag the movement arrows to reposition the ellipsoid widget in the screen. Two movement modes are possible: In the properties panel, you can choose to **Align movement handles to** the **Axes** or the **Camera**. When **Align movement handles to** is set to **Axes**, the handles in the centre of the widget are red, green and blue. Click on one of these arrows and you will be able to drag the widget back and forth along the orientation of your selected axis:

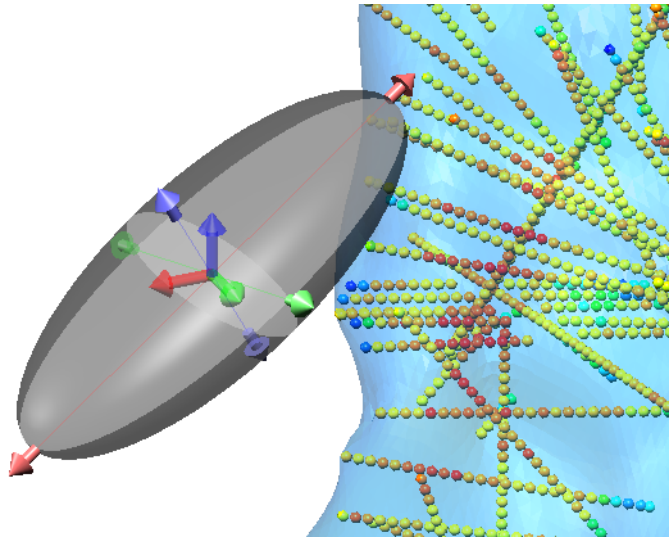

Don't confuse the red, green and blue centre point arrows with the red, green and blue axis adjustment arrows that may appear on the edge of the widget.

When **Align movement handles to** is set to **Camera**, the handles in the centre of the widget are orange. Click on these arrows and you can drag the widget left-and-right and up-and-down in the viewing plane.

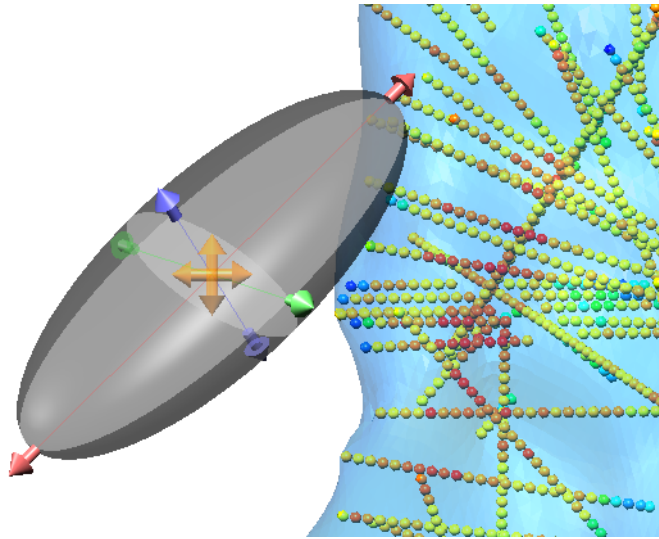

The **Look** button provides options for quickly changing the camera viewpoint.

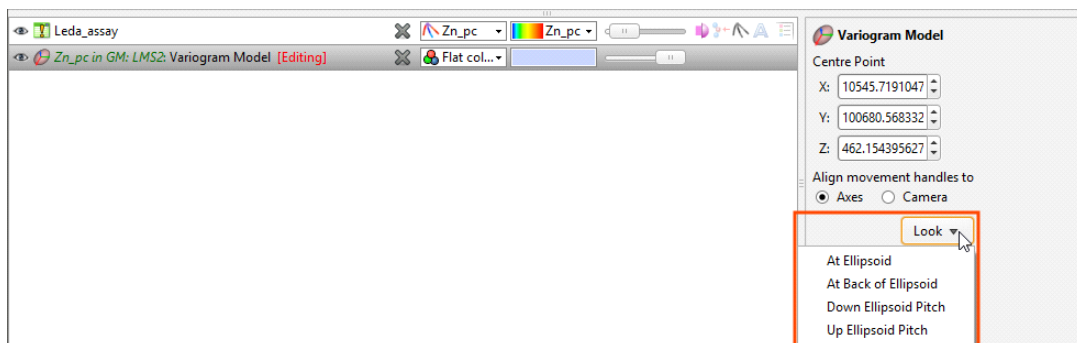

To aid in the visualisation of the ellipsoid, the major-intermediate axial plane and the intermediate-minor axial plane have been drawn and shaded. The major, intermediate and minor axes are also drawn as red, green and blue lines respectively. This assists in visualising the orientation and shape of the ellipsoid. In some views, the planes are exchanged for alternate planes, such as when displaying octant or quadrant search sectors.

Domained Estimations

The features described in this topic are only available if you are licensed to use Leapfrog Edge with Leapfrog Geo.

A dominated estimation describes the boundary and values to be used for an estimation. Once a dominated estimation is defined, you can then define variograms, sample geometries and estimators inside it.

This topic describes how to create and work with a domained estimation. It is divided into:

- [Creating a Domained Estimation](#)
- [The Domained Estimation in the Project Tree](#)
- [Viewing Statistics](#)
- [Copying a Domained Estimation](#)

Creating a Domained Estimation

To create a domained estimation, right-click on the **Estimation** folder and select **New Domained Estimation**. The **New Domained Estimation** window will be displayed:

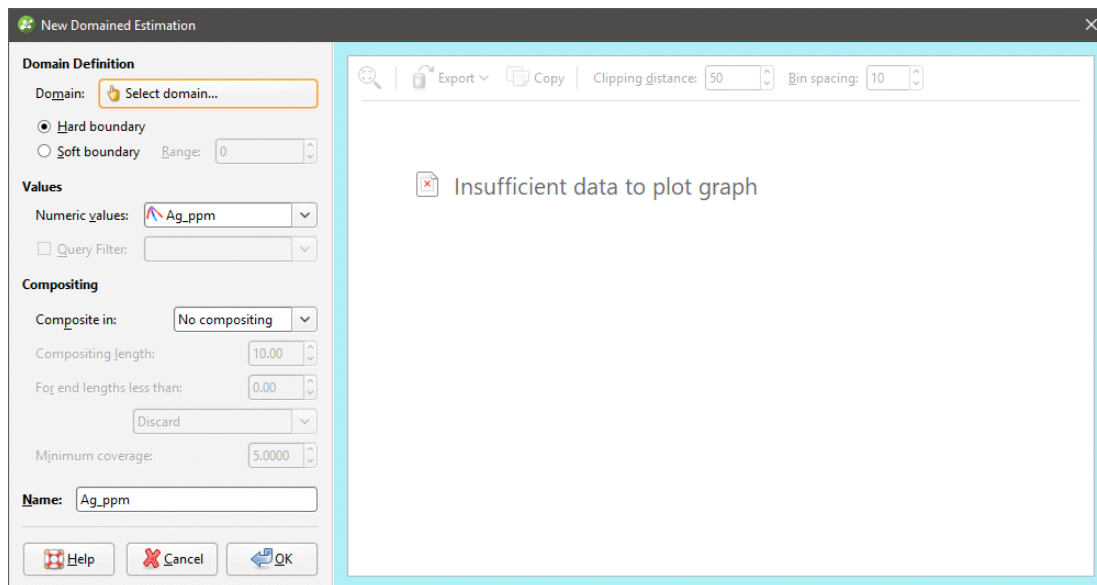

This window is divided into three parts:

- The domain definition
- The values used in the estimation and how they are composited
- The boundary validation chart

Tools in the window allow you to validate the domain and select whether the boundary should be a hard or soft boundary.

Defining the Domain

Click on the **Select domain** button to select from the suitable objects available in the project:

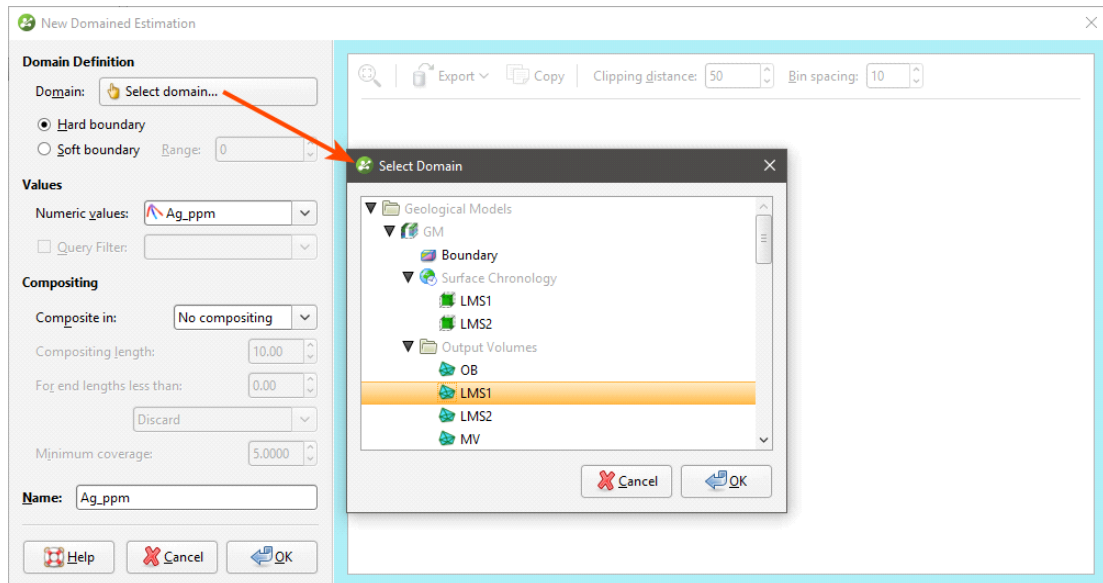

Any closed mesh can be selected to be used as the domain, including boundary objects and model volumes.

The selected domain can be used with a **Hard boundary** or **Soft boundary**. It is essential to the integrity of an estimate to select the type of boundary according to the real nature of the mineralisation. This is discussed in more detail in [Boundary Validation](#) below.

A **Hard boundary** uses only data within the domain's boundary. This can be seen when you add a domained estimation to the scene; the values used do not extend beyond the boundary:

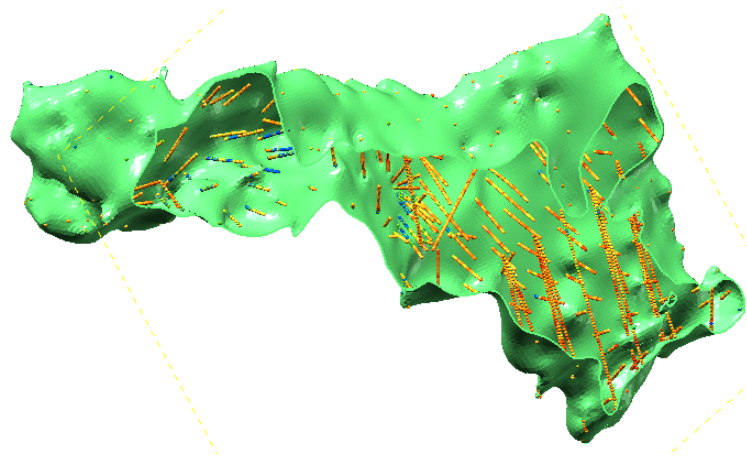

A **Soft boundary** will also make use of data beyond the domain boundary, up to the distance specified in the **Range** field. Here, the range is set to 10 and we can see that values outside the boundary are used:

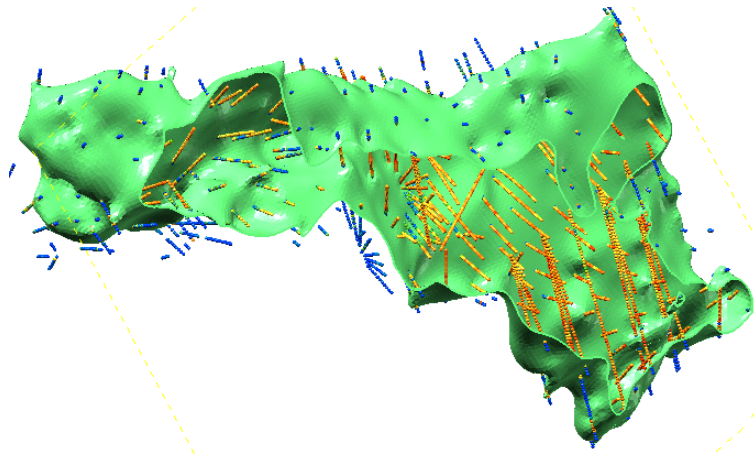

The **Soft Boundary** option provides the ability to create estimation objects strictly within the selected boundary, but to inform those estimation objects using relevant data immediately adjacent to but beyond the boundary.

- A fully soft boundary can be achieved by setting the **Range** to its maximum value.
- A semi-soft boundary can be achieved by constraining the **Range** to a lower value.

When a soft boundary is used, the values are taken within the specified range, measured perpendicular to the domain rather than along a drillhole. This prevents errors arising from drillholes at acute angles to the domain boundary.

Selecting Values

In the **Values** part of the **New Domained Estimation** window, select the values that will be used. If you have defined a query filter, you can use it to filter the values for the domained estimation by selecting it from the **Query Filter** list. Once the domained estimation has been created, you can remove the filter or select a different filter.

You can build a domained estimation from either:

- Numeric data contained in imported drillhole data, including composited data
- Points data imported into the **Points** folder

All suitable data in the project is available from the **Numeric values** list.

Setting Compositing Options

When numeric values from drillhole data are used to create the domained estimation, you can composite the data to simplify the geology for the purposes of estimation. If you do not have specific **Compositing** values in mind, you may wish to leave this option blank as it can be changed once the model has been created.

If the numeric values selected have already been composited, the **Compositing** settings will not be available in the **New Domained Estimation** window. Drillhole data can be composited directly by right-clicking on the **Composites** folder (under the **Drillholes** object) and selecting **New Numeric Composite**. See [Numeric Composites](#).

There are three compositing options:

- **No compositing**
- **Entire drillhole**
- **Within boundary**

The compositing settings available depend on whether the boundary type is a hard or soft boundary. For soft boundaries, compositing is limited to the **Entire drillhole** option, whereas for hard boundaries, compositing can also be limited to the data within the domained estimation's boundary.

See [Numeric Composites](#) for more information on the effects of the **Compositing length**, **For end lengths less than** and **Minimum coverage** settings.

When selecting compositing options, you may see a message: **Warning: missing numeric data**. This is not an error, but alerts you that some intervals are missing data.

Boundary Validation

Once you have selected the domain and the values you wish to use and set compositing options, the boundary analysis tools in the **New Domained Estimation** window help you to determine the best type of boundary to use:

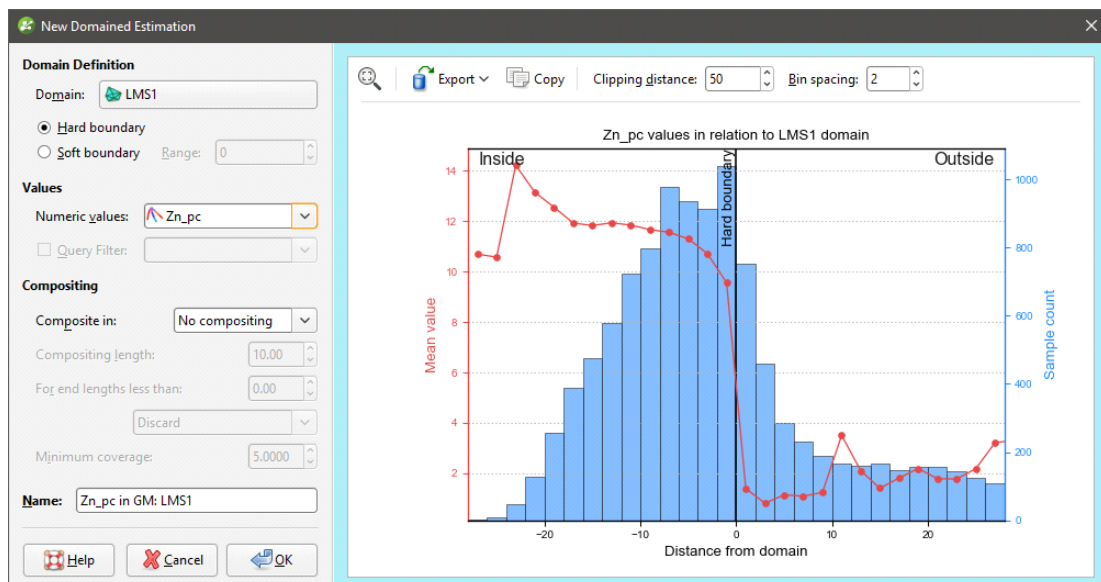

If compositing is enabled for the domained estimation, the boundary validation information displayed is that for the uncomposited data.

A histogram of the sample count for each bin is included, so you can ignore things like an anomalous spike in mean grade associated with a very small sample count. Adjust the size of the horizontal axis bins using the **Bin spacing** setting.

The pale blue bars show the sample count for each bin, and the red dotted line segment plot shows the mean grade for the bin. The position of the **Hard boundary** is marked with a solid black vertical line. When a **Soft boundary** is selected, a vertical dotted blue line appears to show what values will be included, based on the **Range** setting. You can click on the soft boundary line and drag it to adjust the range:

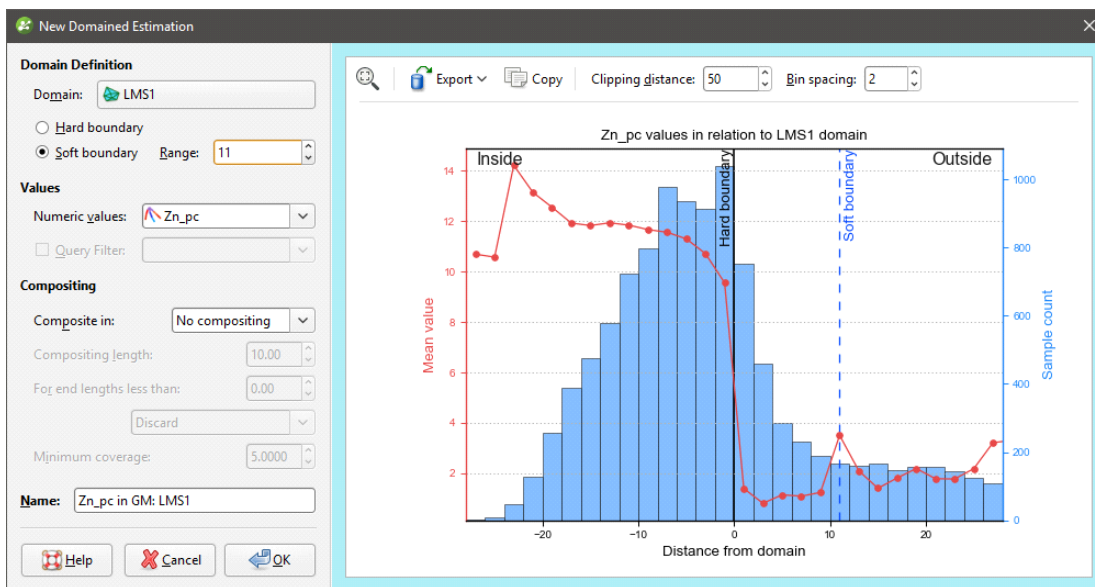

When the mean grade line segment plot shows a sharp change at the boundary, a hard boundary may be appropriate. Click on points in the line segment plot to see statistics relating to the selected point.

To zoom the x-axis of the chart:

- Use the scroll wheel on your mouse to zoom in or out.
- Reset the zoom level by clicking the **Reset view** button (🔍).

The number to the left of the **Bin spacing** is the **Clipping distance**. This constrains the calculation of the graph to the specified distance from the domain, to improve application responsiveness. You can choose to set the distance to be right at the limit of the x-axis for maximum performance, or increase the distance to plot additional points to be visible when zooming out.

You can export the chart for use in external reports and other documents. There are three options:

- The **Export data as CSV** option (📄) saves a CSV file containing the data so it can be reproduced and reformatted in a spreadsheet application.
- The **Export graph image** option (🖨️) saves a PDF, SVG or PNG file of the chart.
- The **Copy graph image** option (📋) saves a copy of the chart image to the Windows clipboard for pasting into another application.

Note that when the **Export data as CSV** option is used, it is the last three columns (**Starting bin edge, Mean grade and Sample count**) that are required to reproduce the chart. The first two columns, **Signed distance to boundary** and **Numeric value**, contain all the data points required to create a new chart with different bin spacing:

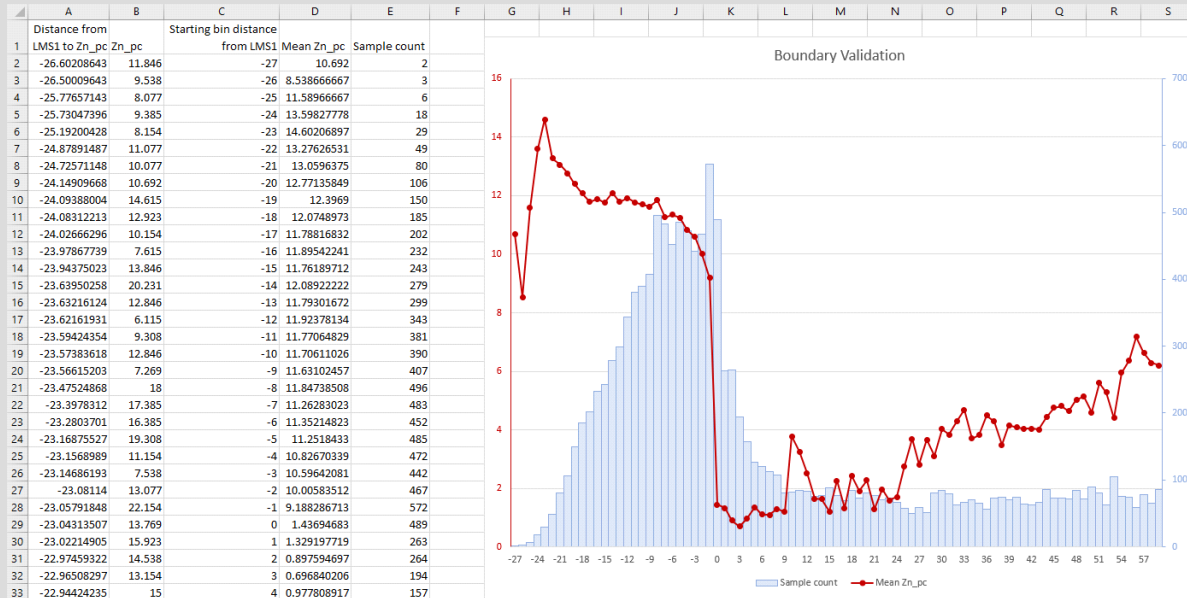

The Domained Estimation in the Project Tree

Once you have entered a name for the domained estimation, click **OK**. The domained estimation will be added to the project tree under the **Estimation** folder. You can edit its settings by double-clicking on it.

A domained estimation is made up of the following objects:

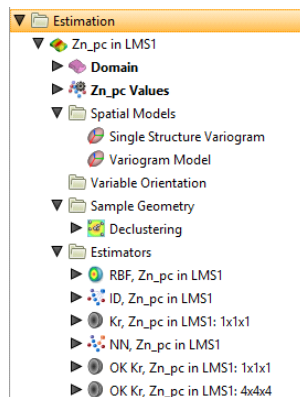

- The **Domain** defines the limits of the estimation object. To select another domain, double click on the domained estimation and click the **Domain** button to select a new mesh.
- The points data values object contains all the data used in generating the estimation object. These comprise midpoints for all the value intervals. You can easily change the values used by selecting a different **Numeric values** column or by applying an optional query filter.

- The **Spatial Models** folder contains variogram models. Create a variogram model by right-clicking on the **Spatial Models** folder and selecting **New Variogram Model**. See [Variogram Models](#) for more information.
- The **Variable Orientation** folder is used for creating objects that make it possible to re-orient the search and variogram according to local characteristics. See [Variable Orientation](#) for more information.
- The **Sample Geometry** folder contains data density functions that can be used when declustering data. See [Sample Geometries](#) for more information.
- The **Estimators** folder contains estimators that can be evaluated onto block models. Estimators are similar to Leapfrog RBF interpolants, with the exception that estimators select and refer to an independently constructed variogram model. See [Estimators](#) for more information.

You can view a domained estimation by dragging it into the scene; this adds the **Domain** and **Values** objects to the scene.

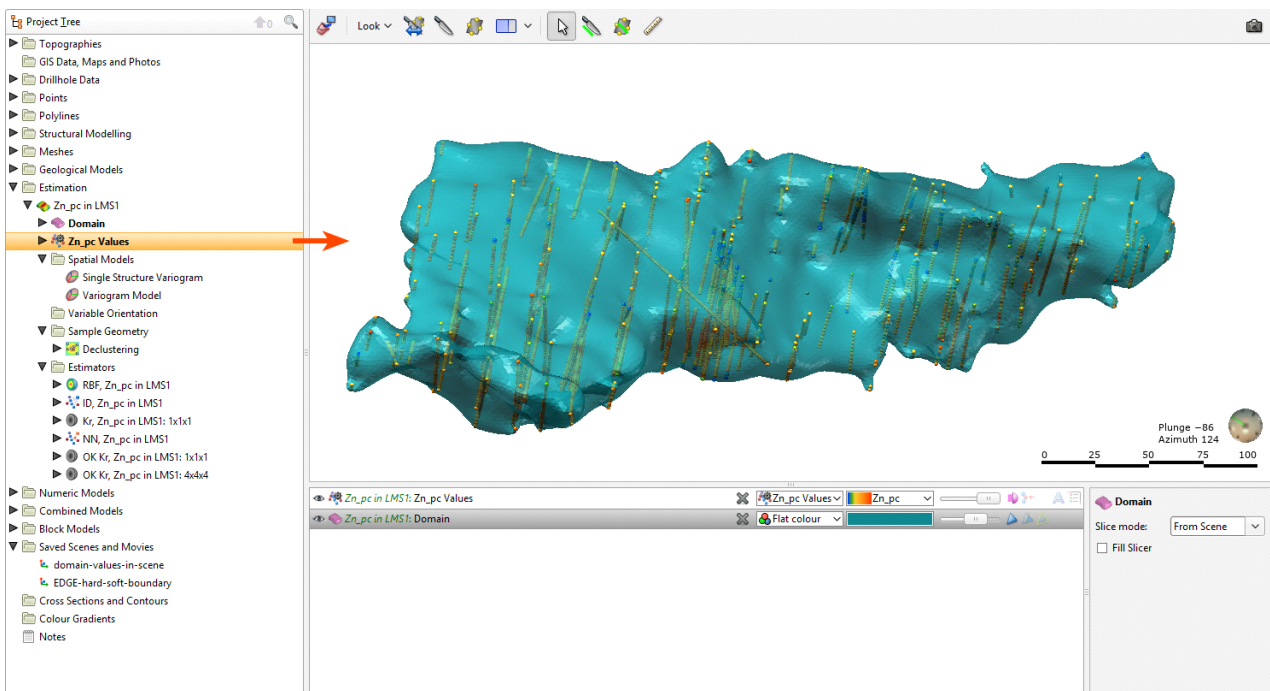

Viewing Statistics

You can view statistics for the values used in the domained estimation by right-clicking on the numeric data object and selecting **Statistics**:

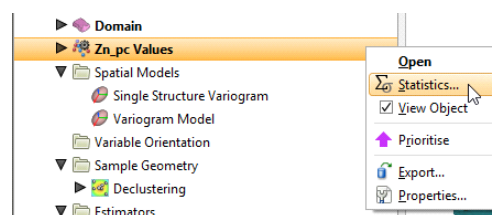

Selecting **Statistics** will open a dockable tab window displaying the **Univariate** histogram of the point values.

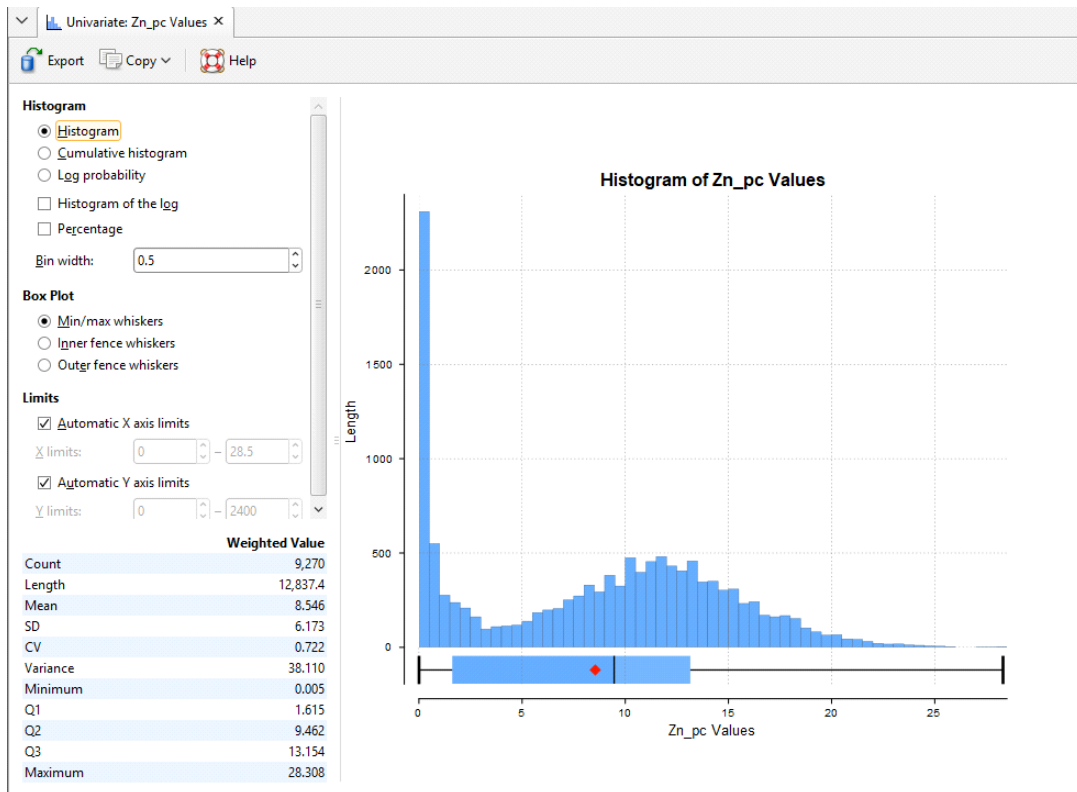

For more details on univariate statistics, see [Analysing Data](#).

Copying a Domained Estimation

Reusing the same variograms, spatial models and estimators can be achieved by copying a domained estimation and then changing its boundary and values. Organising estimations in this way allows you to define a set of spatial functions and estimators that can then be reused with different values. For example, if you have multiple domains to estimate, you can define one, copy it, then change that copy's domain to one of the additional domains. Or you could experiment with different hypotheses: once you have defined a set of spatial functions and estimators, you can make a copy of the domained estimation and change that copy's values and boundary. Because the variograms and sills are normalised to the data variance when copying a domained estimation, you can change the values selection to a different data column and the sills and variance will be rescaled to the new data column's variance.

Variogram Models

The features described in this topic are only available if you are licensed to use Leapfrog Edge with Leapfrog Geo.

Variography is the analysis of spatial variability of grade within a region. Some deposit types, e.g. gold, have high spatial variability between samples, whereas others, e.g. iron, have relatively low spatial variability between samples. Understanding how sample grades relate to each other in

space is a vital step in informing grades in a block model. A variogram is used to quantify this spatial variability between samples.

In estimation, the variogram is used for:

- Selecting appropriate sample weighting in Kriging and RBF estimators to produce the best possible estimate at a given location
- Calculating the estimators' associated quality and diagnostic statistics

In Leapfrog Geo domained estimations, variograms are created and modified using the **Spatial Models** folder. To create a new variogram model, right-click on the **Spatial Models** folder and select **New Variogram Model**.

A new variogram model is not auto-fitted and should not be assumed to be the initial hypothesis for the workflow. While some reasonable defaults have been selected for the variogram model, the geologist's personal hypothesis should be the starting point for the estimation workflow.

You can define as many variograms as you wish; when you define an estimator that uses a variogram model, you can select from those available in the domained estimation's **Spatial Models** folder:

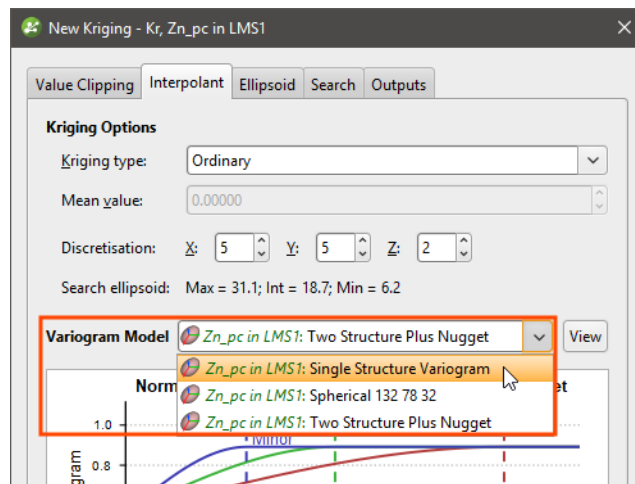

Working with variograms is an iterative process. The rest of this topic provides an overview of the **Variogram Model** window and describes how to use the different tools available for working with variograms. This topic is divided into:

- [The Variogram Model Window](#)
- [Variogram Model Controls](#)
- [Experimental Controls](#)

See [The Ellipsoid Widget](#) for information that is useful in working in the **Variogram Model** window.

The Variogram Model Window

The **Variogram Model** window is divided into three parts:

The screenshot shows the 'Spherical 132 78 32' window. It is divided into three main sections:

- Section 1 (Top Right):** Variogram Model controls. This section includes fields for Direction (Dip, Dip Azimuth, Pitch), Variogram Model parameters (Nugget, Structure 1, Structure 2, Total sill, Variance), and model settings (Type, Alpha, Major, Semi-major, Minor). A red circle '1' is placed over the Variogram Model parameters.
- Section 2 (Bottom Right):** A graph titled 'Variogram for Zn_pc Values'. The y-axis is '(Semi-)Variogram (21.3085)' and the x-axis is 'Distance'. The graph shows three curves: Minor (blue), Semi-maj (green), and Maj (red). Vertical dashed lines indicate the range for each axis. A red circle '2' is placed over the graph.
- Section 3 (Left):** Experimental Variograms controls. This section includes a tree view for 'Variogram Model' (with sub-items like Axis Aligned Variograms, Radial Plot, Major Axis, Semi-major Axis, Minor Axis, Downhole Variogram), Capping options (Lower bound, Upper bound, Variance), General settings (Lag distance, Lag tolerance, Number of lags, In Plane/Off Plane, Angle tolerance, Bandwidth), and Radial Plot settings (Radial divisions). A red circle '3' is placed over the tree view.

1	Variogram model controls for adjusting the variogram model type, trend and orientation. See Variogram Model Controls below.
2	Graphs plotting the selected variogram
3	Experimental controls for verifying the theoretical variogram model. See Experimental Controls below.

When you edit a variogram model in the **Variogram Model** window, an ellipsoid widget is automatically added to the scene. The ellipsoid widget helps you to visualise the variogram in 3D, which is useful in setting variogram rotation and ranges and in defining search neighbourhoods. See [The Ellipsoid Widget](#) for more information.

If the **Variogram Model** window is docked as a tab, you can tear the window off. As a separate window, you can move and resize the window so you can see the ellipsoid change in the 3D scene while you make adjustments to the model settings. The detached window can be docked again by dragging the tab back alongside the other tabs, as described in [Organising Your Workspace](#).

There are two ways to save the graph for use in another application:

- Click the **Export graph** button (📄) to export the graph as a PDF, PNG or SVG file.
- Click the **Copy graph** button (📄) to copy the graph to the clipboard. You can then paste it into another application.

There are two buttons for refreshing the graphs when changes are made:

- When **Auto Refresh** is enabled, recalculations will be carried out each time you change a variogram value. This can produce a brief lag.
- When auto refresh is disabled, you can click the **Refresh** button (🔄) whenever you want the graphs to be updated. This is the best option to use when working with a large dataset.

If auto refresh is disabled and values have been changed without the graphs being updated, the chart will turn grey and a reminder will be displayed over it:

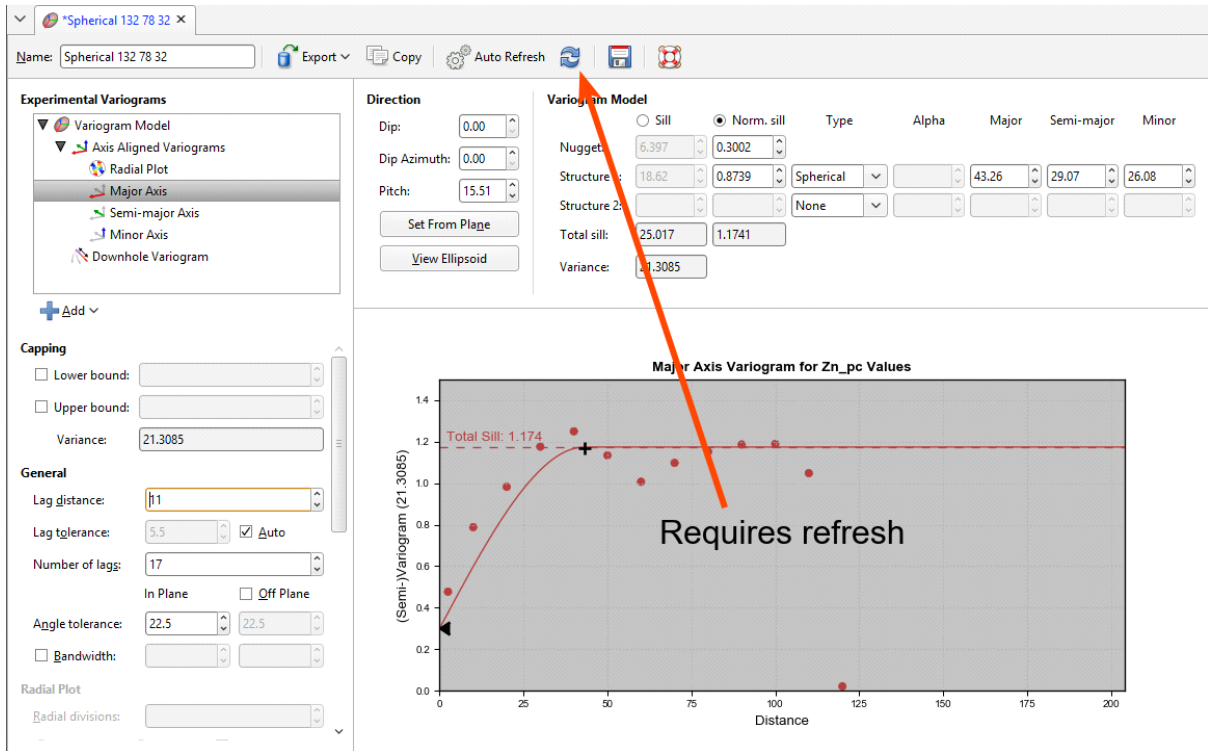

Variogram Model Controls

The **Variogram Model** controls adjust the variogram model type, trend and orientation. The graph will change as model parameters are adjusted. The ellipsoid in the scene will also reflect the changes you make to the **Variogram Model**.

Multi-structured variogram models are supported, with provision for nugget plus two additional structures.

The **Nugget** represents a local anomaly in values, one that is substantially different from what would be predicted at that point based on the surrounding data. Increasing the value of **Nugget** effectively places more emphasis on the average values of surrounding samples and less on the actual data point and can be used to reduce noise caused by inaccurately measured samples.

Each additional structure has settings for the component **Sill** and the normalised sill, labelled **Norm. sill**, model **Type**, **Alpha** (if the model type is spheroidal), and the **Major**, **Semi-Major** and **Minor** ellipsoid ranges.

The **Sill** defines the upper limit of the model, the distance where there ceases to be any correlation between values. The **Sill** can be set for the **Nugget**, **Structure 1** and **Structure 2**. A

spherical variogram reaches the sill at the range and stays there for increasing distances beyond the range. A spheroidal variogram approaches the sill near the range, and approaches it asymptotically for increasing distances beyond the range. The distinction is insignificant. A linear model has no sill in the traditional sense, but along with the ellipsoid ranges, the sill sets the slope of the model. The two parameters sill and range are used instead of a single gradient parameter to permit switching between linear, spherical and spheroidal interpolant functions without also manipulating these settings.

The **Norm. sill** represents the same information as the **Sill**, but proportionally scaled to a range between 0 and 1, where 1 represents the data **Variance**. As you select the radio buttons for **Sill** and **Norm. sill**, the Y-axis scale on the displayed chart will change to correspond to your selection.

The **Total sill** is the sum of the component sills for both the data sills and the normalised sills.

The **Variance** is calculated automatically from the data and shows the magnitude of the variance for the dataset.

Linear, Spherical and Spheroidal Model Options

The model **Type** provides three options: **Linear**, **Spherical** and **Spheroidal**.

Linear is a general-purpose multi-scale option suited to sparsely and/or irregularly sampled data. **Spherical** and **Spheroidal** are suitable for modelling most metallic ores, where there is a finite range beyond which the influence of the data should fall to zero. A **Spherical** model has a range beyond which the value is the constant sill. A **Spheroidal** model flattens out when the distance from the sample data point is greater than the range. At the range, the function value is 96% of the sill with no nugget, and beyond the range the function asymptotically approaches the sill. Each axis of the variogram ellipsoid has its own range, adjusted using **Major**, **Semi-Major** and **Minor**. The ranges are colour-coded in the variogram model plot.

The spherical model is not available for standard Leapfrog RBF interpolants created in the **Numeric Models** folder.

Alpha is only available when the model **Type** is **Spheroidal**. The **Alpha** constant determines how steeply the interpolant rises towards the **Sill**. A low **Alpha** value will produce a variogram that rises more steeply than a high **Alpha** value. A high **Alpha** value gives points at intermediate distances more weighting, compared to lower **Alpha** values. An **Alpha** of 9 provides the curve that is closest in shape to a spherical variogram. In ideal situations, it would probably be the first choice; however, high **Alpha** values require more computation and processing time, as more complex approximation calculations are required. A smaller value for **Alpha** will result in shorter times to evaluate the variogram.

RBF estimators will only work when the **Structure 2** model **Type** is set to **None**.

Normalised Y Axis

A key use of copying a variogram is to apply it to another geologically correlated mineral resource. This would typically be accomplished, having determined the appropriate variogram using the values for one mineral, by copying the domained estimation and changing the

Numeric values field to a different mineral. However, the absolute values for the nugget and sills for each structure would be completely inappropriate for the new mineral; while we desire the shape to be the same, the values for different mineralisations will inevitably be different. To make this work correctly, the variogram is normalised or standardised, rescaling the range of Y-axis values to between 0 and 1, where 1 is equivalent to the data **Variance**. This makes the variogram information portable between domained estimations. This is performed automatically, requiring no intervention on your part.

You can freely switch between the **Sill** and **Norm. sill** options. The selection only changes the Y-axis scale on the displayed chart.

You do not need to select the **Normalised** option before copying the domained estimation and using it as the basis for a different mineral resource. The normalised scale will always be used when applying the variogram model to the new data set.

As you adjust the **Nugget** or the **Structure 1** or **Structure 2** sill values, the **Total sill** will change both for the absolute **Sill** values and the **Norm. sill** values. The **Norm. sill** total may end up being something other than 1.0. This is expected, as the value reference for the normalised scale uses the data **Variance** for 1.0, not the total sill.

Note that the data **Variance** is recorded in the Y axis label so the chart scale is always meaningful, including when the chart is exported.

Direction

The trend **Direction** fields set the orientation of the variogram ellipsoid. Adjust the ellipsoid axes orientation using the **Dip**, **Dip Azimuth** and **Pitch** fields.

The **Set From Plane** button sets the trend orientation of the model ellipsoid based upon the current settings of the moving plane.

The **View Ellipsoid** button adds a 3D ellipsoid widget visualisation to the scene.

Experimental Controls

A variogram model can be verified through the use of the experimental variography tools that use data acquired in the drilling process. Use these to find the directions of maximum, intermediate and minimum continuity.

The variogram displayed in the chart is selected from the variograms listed in the panel in the top left corner of the window.

The top entry in the variograms list is the theoretical variogram model rather than an experimental variogram:

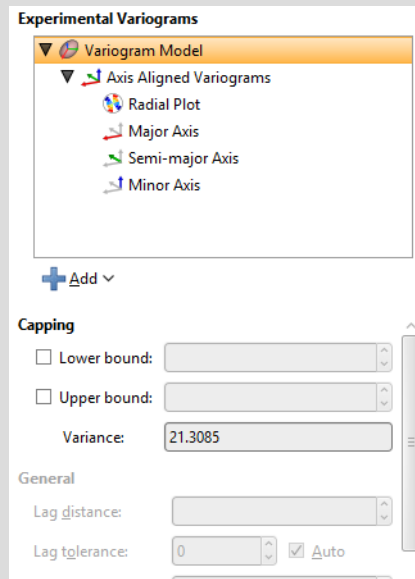

All other variograms in the list and the other controls on the left-hand side of the screen relate to **Experimental Variograms**.

By default, there is a set of **Axis Aligned Variograms**. Use the **Add** button to add additional experimental variograms. You can add one **Downhole Variogram** and any number of **Custom Variograms**.

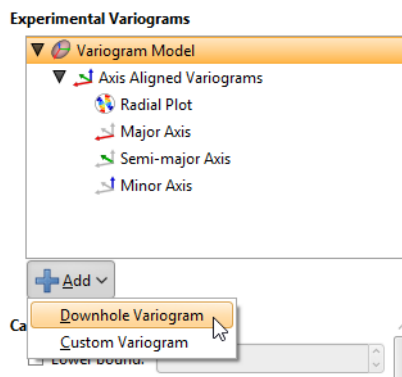

Click on one of these experimental variograms to select it and display its parameters. The displayed graph will change to match this selection. For example, here the graph and settings for the **Axis Aligned Variograms** are displayed:

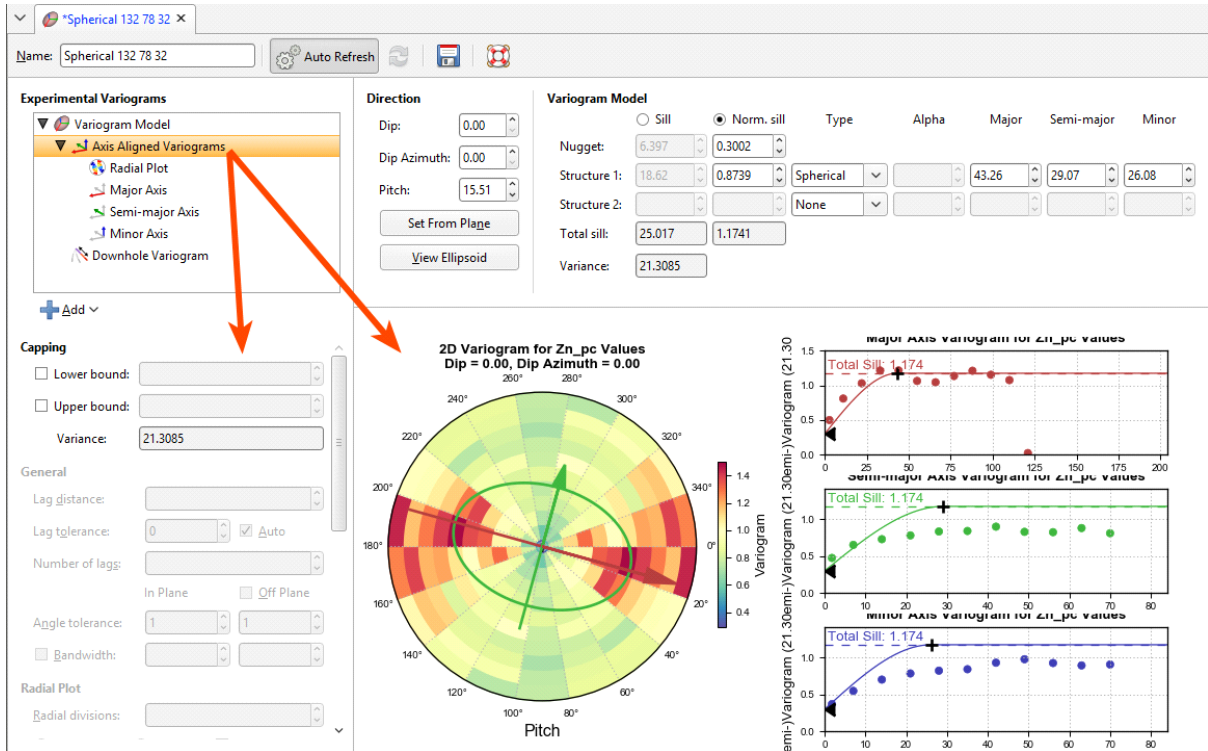

Selecting the **Semi-major Axis** variogram changes the chart and settings displayed:

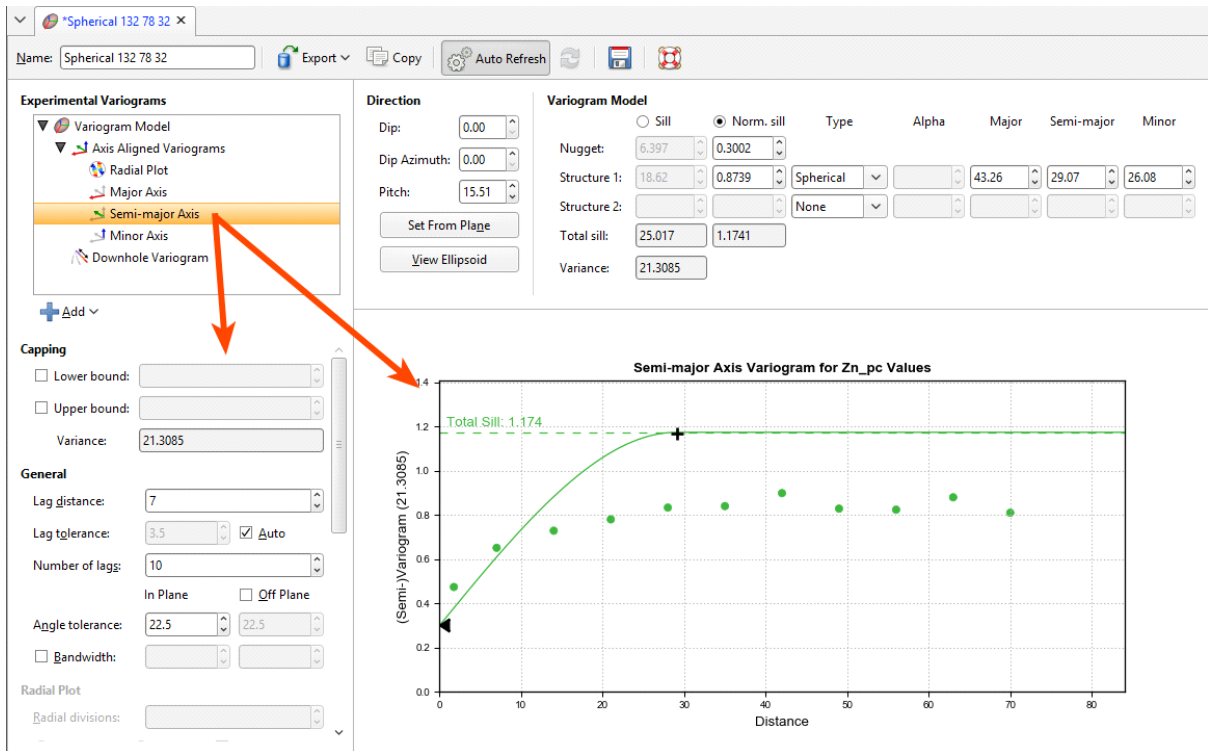

Adjust the model variogram parameters to see the effect different parameters have when applied to the actual data.

Experimental Variogram Parameters

The experimental variogram controls along the left side of the window define the search space, define the orientation for custom variograms and change how the variograms are displayed. Some parameters are only available for some variogram types; these are discussed in later sections on each variogram type.

Capping

Data **Capping** fields limit the values of the **Lower bound** and **Upper bound** for the data as specified. This is not a filter that discards these points, but values below or above the caps are treated as if the value was the lower or upper bound.

Defining the Search Space

The first set of parameters controls the search space.

- **Lag distance** controls the size of the lag bins. The first bin will be one quarter of the size of the **Lag distance**. Experimental variograms generally measure lags as distances along a direction vector, though downhole variograms measure lags as distances along the drillholes.
- **Lag tolerance** allows for the reality that data pairs are rarely the same distance apart. The data is scanned and pairs are assembled after applying a **Lag tolerance** to the **Lag distance**. If the **Lag toleranceAuto** box is ticked, Leapfrog Geo defaults to using a **Lag tolerance** of half the **Lag distance**. Controlling the **Lag tolerance** explicitly allows you to test the sensitivity of the variogram. Typically, a larger value will be used for sparse datasets and a smaller value for dense datasets.

Some software treats a **Lag tolerance** of 0 as a special value that does not mean 'no lag tolerance' but instead is interpreted as meaning half the **Lag distance**. In Leapfrog Geo, it is possible to set **Lag tolerance** to 0, but this means literally what the number implies: there is no **Lag tolerance** and the only data pairs that are displayed are those that occur exactly at the **Lag distance** spacing.

- **Number of lags** constrains the number of lag bins in the search space.
- The **In Plane** and **Off Plane Angle tolerance** and **Bandwidth** settings define the search shape, and the effects of these settings are discussed in more detail below.

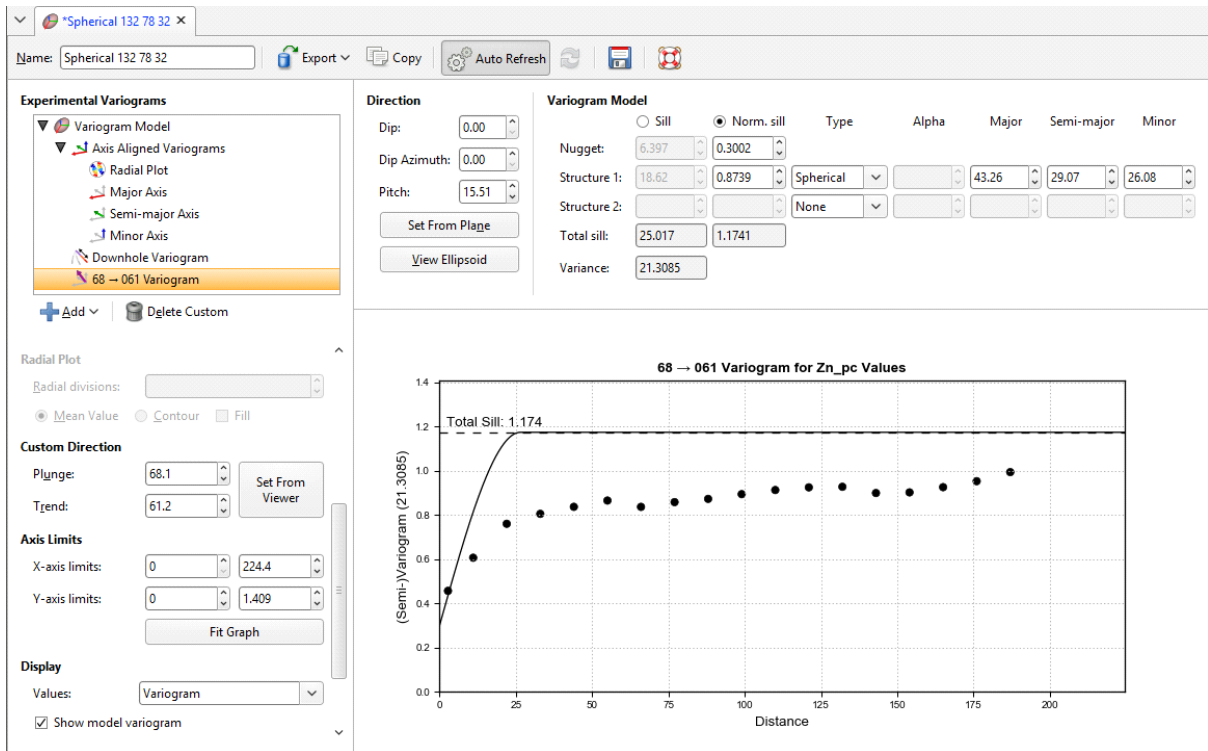

The search shape usually approximates a right rectangular pyramid on a rectangular parallelepiped. The pyramid and parallelepiped will be square if the **In PlaneAngle tolerance** and **Bandwidth** are used without defining **Off Plane** values. Using the **Off PlaneAngle tolerance** and **Bandwidth** fields will make the shape rectangular. The plane being referred to is the major-intermediate axis plane of the variogram ellipsoid, the same plane used for the radial plot. The **Angle tolerance** is the angle either side of a direction vector from the data point origin. Once the sides of the pyramid defined by the angle tolerances extend out to the limits specified by the **Bandwidth**, the search neighbourhood is constrained to the bandwidth dimensions.

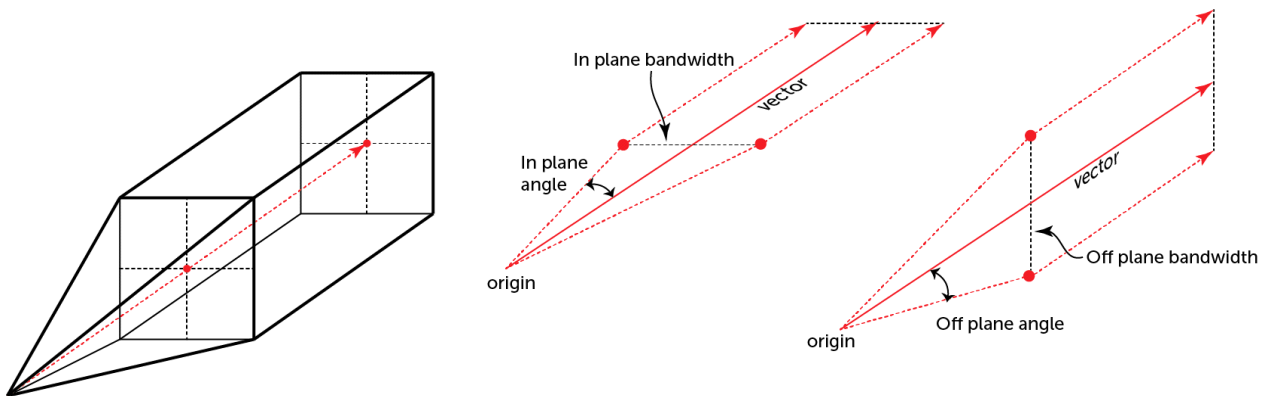

The search shape becomes a more complex “carpenter’s pencil” shape when a wide **In Plane** angle and a narrow **Bandwidth** are defined along with a narrow **Off Plane** angle and a wide **Bandwidth**, or vice versa. This rendering should assist in visualising the shape; the major axis is shown in red, the semi-major axis is shown in green, and the orthogonal minor axis in a transparent blue:

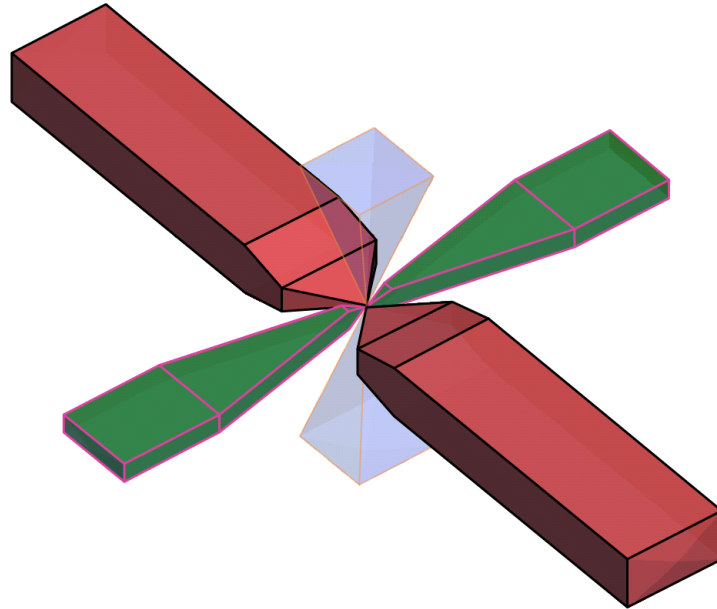

Note that although not shown here, the outer ends of the search shapes are not flat, but rounded, being defined by the surface of a sphere with a radius of the maximum distance defined by the number of lags and their size.

Off Plane Angle tolerance and **Bandwidth** settings cannot be set for the minor axis variogram. Because the angle tolerance and bandwidth are described relative to the major-intermediate plane and because the minor axis is orthogonal to this plane, only one angle can be described. This results in a square pyramid search shape.

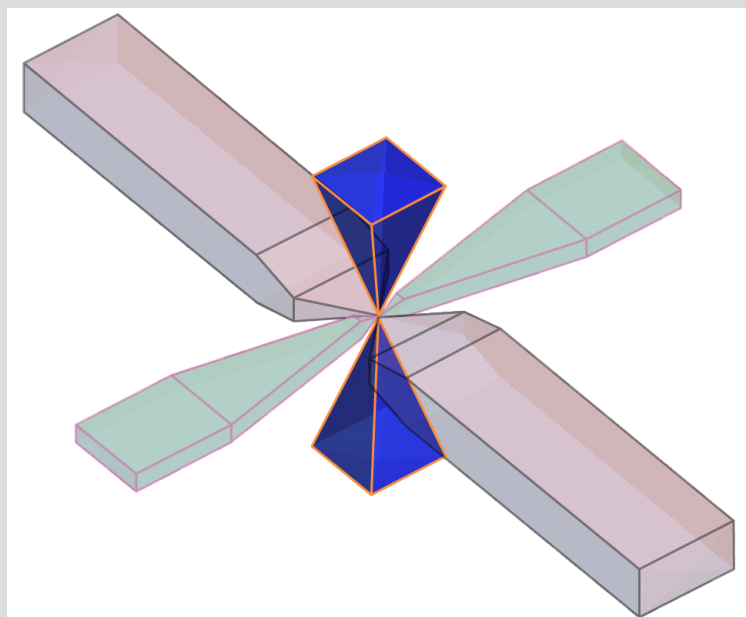

The **In Plane Bandwidth** also cannot be set for the **Minor Axis**.

Note that although not shown here, the outer ends of the pyramids are rounded, defined by the surface of a sphere with a radius of the maximum distance defined by the number of lags and their size.

Radial Plot Parameters

Radial Plot has parameters specifically for the radial plots in **Axis Aligned Variograms**.

Increasing the **Radial divisions** increases the resolution of the radial plot, with each block in the radial plot covering a smaller arc of the compass. Using a high value will increase the resolution used to improve precision, but this carries a calculation time cost. Using a smaller number will be faster, but will be less useful for observing directions of continuity. The default value of 8 is fast, but you may want to turn off **Auto Refresh Graphs** and increase the number of **Radial divisions** before clicking **Refresh graphs**.

Mean Value will display radial plot bins coloured to indicate the mean value for each bin.

Contour will display a plot showing lines of equal value. **Fill** shades the chart between the contour lines.

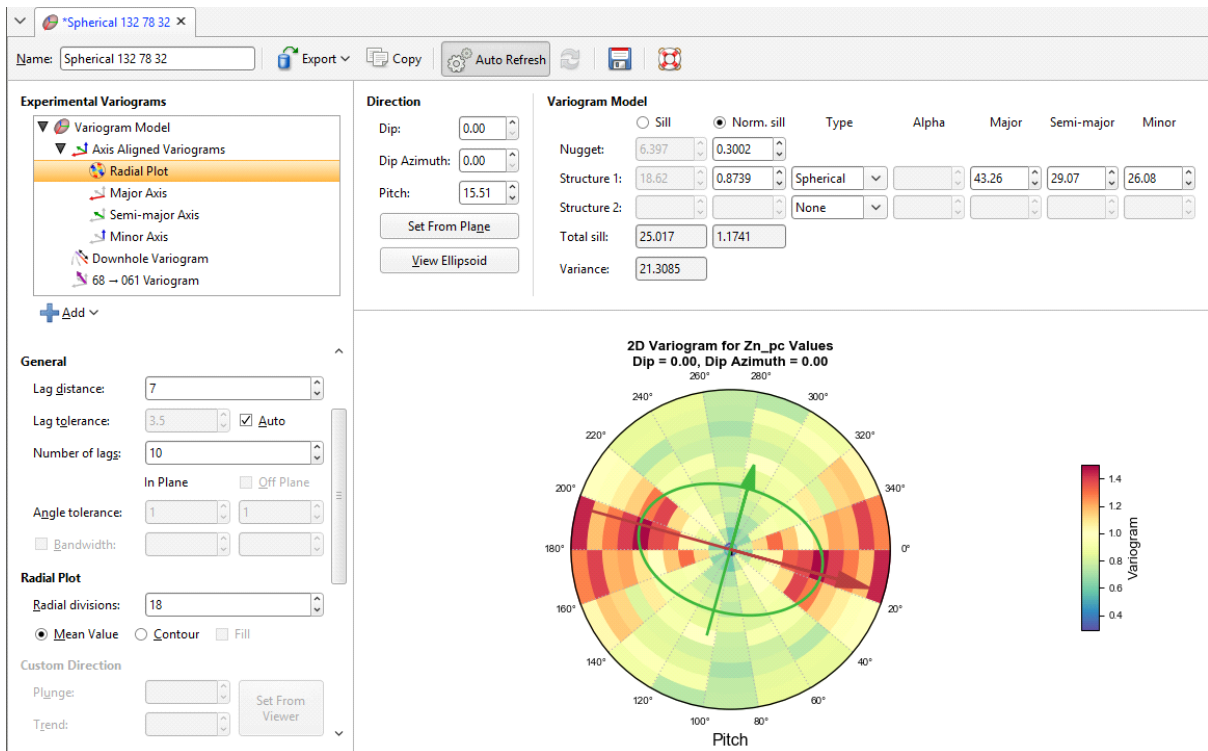

Orienting Custom Variograms

The **Custom direction** fields are for **Custom Variograms** that use the **Plunge to Trend** settings to orient the variogram trend. They can easily be set by orienting the scene view and then clicking the **Set From Viewer** button, which sets the plunge and trend to that of the scene view.

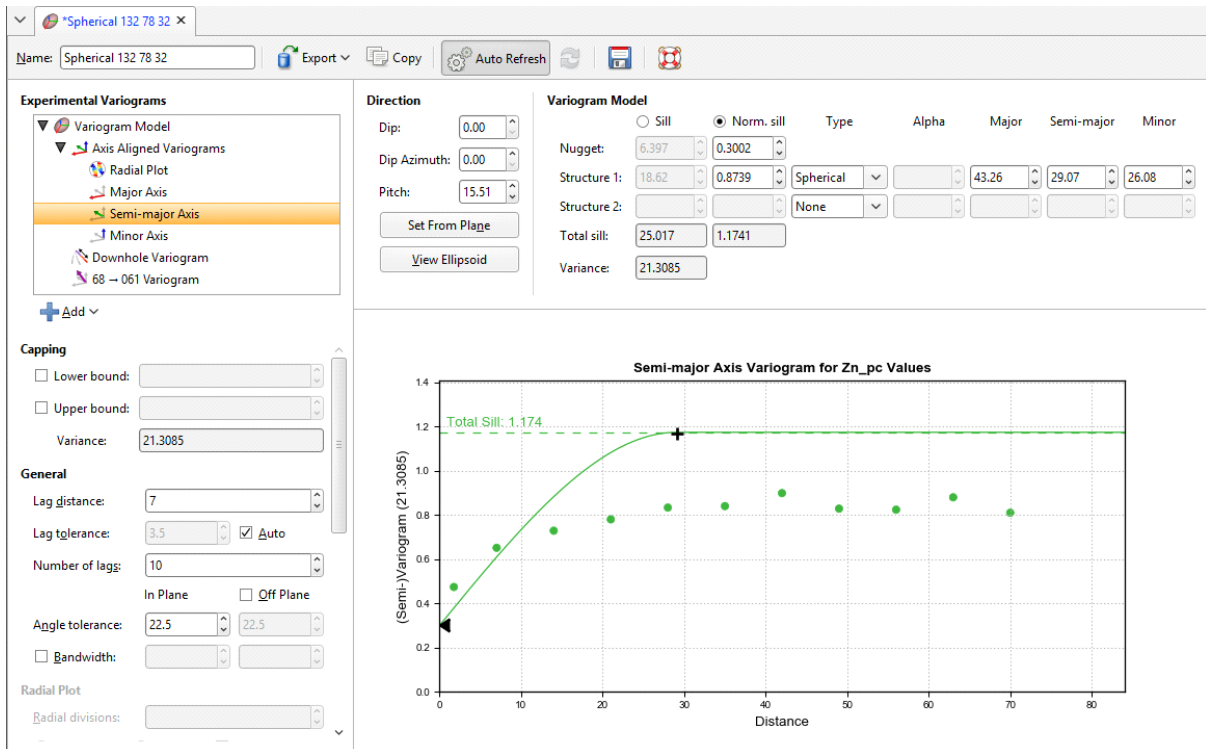

Changing Variogram Display

The **Axis Limits** settings control the chart scaling.

X axis limits and **Y axis limits** control the ranges for the X-axis and Y-axis and can effectively be used to zoom the chart. You can directly control these by manipulating the axes with your mouse. Click and drag an axis to increase or decrease the maximum limit of the axis. Right-click and drag an axis to reposition the axis so the minimum value on the axis is not zero. Double-click the axis to reset the axis minimum and maximum range to the default values.

The **Display** settings change how the variogram is displayed:

- **Values** offers a variety of options to plot on the chart: **Variogram**, **Correlogram**, **Covariance**, **Relative Variogram** and **Pair-wise Variogram**.
- **Show model variogram** plots the variogram on the chart.
- **Show pair count** annotates the chart with the count of data point pairs.
- Tick the **Scale points to pair size** checkbox and the chart will display the plotted points with dots that scale to the size of the pair count. Choose **Actual** so the dots represent the pair size proportionally and **Inverse** to see larger dots for lower pair counts.
- Tick **Moving avg** for a rolling mean variogram value, drawn on the variogram plots in

orange. Next to it, select a value for the window size relative to the **Lag distance**. The window size will be the given number times the lag distance. This window, centred on x, will be used to plot y, the average of all the variogram values falling inside the window.

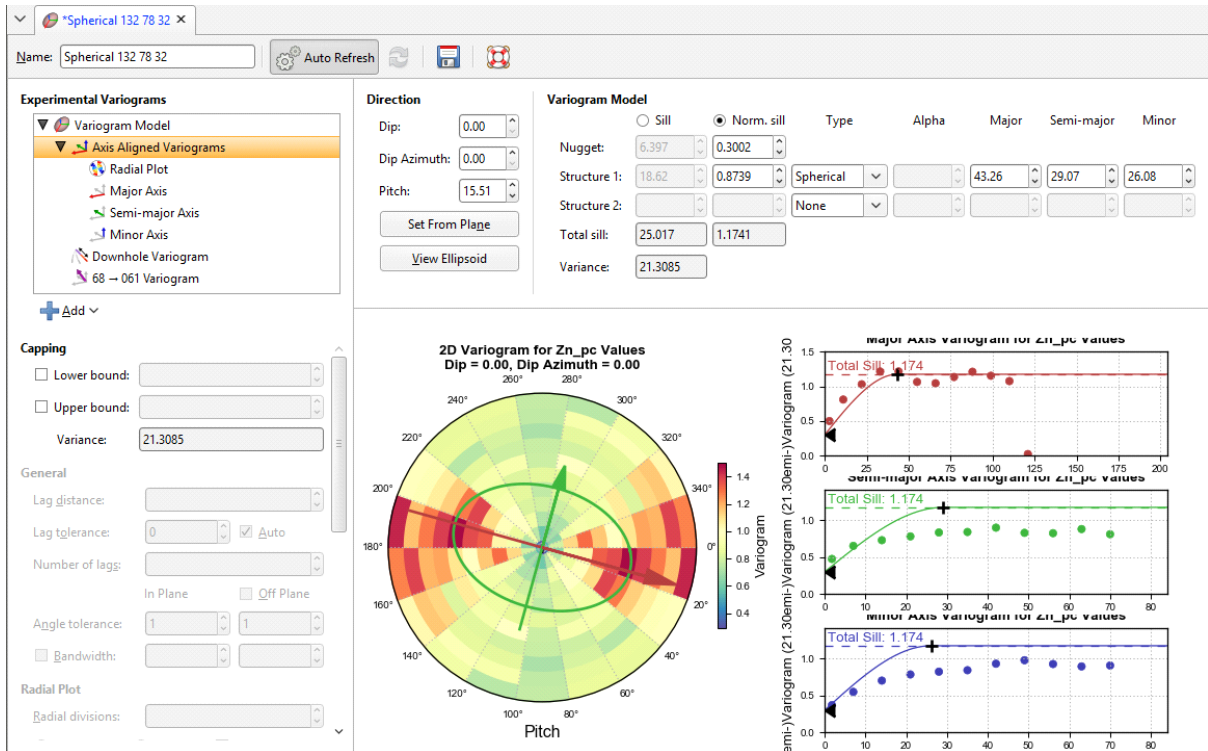

The Downhole Variogram

The **Downhole Variogram** can be used to better define the nugget. It looks only looks at pairs of samples on the same drillhole and uses the differences in depths to calculate the lag value. As it isn't associated with a specific direction, the **Angle tolerance** parameter is not available for the **Downhole Variogram**.

The **Downhole Variogram** chart does not plot the model variogram line; instead it shows a dotted horizontal line indicating the **Total Sill** and, if **Sill** is chosen instead of **Normalised Sill**, the variance.

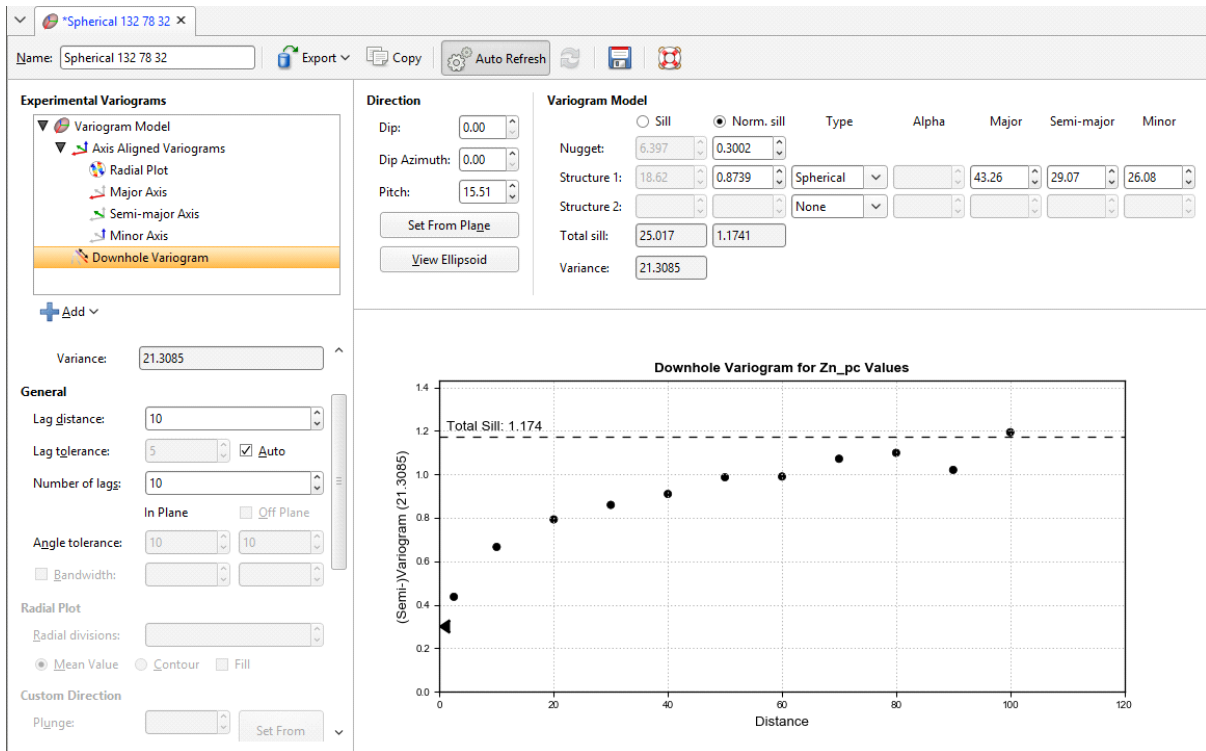

A triangular dragger handle next to the chart's Y-axis can be used to adjust the **Nugget** value in the **Model Controls** part of the window. As the downhole values are nearly continuous, an accurate estimate can be made for the nugget effect for this direction.

Axis Aligned Variograms

The **Axis Aligned Variograms** are useful for determining the direction of maximum, intermediate and minimum continuity. When you select the **Axis Aligned Variograms** option, all four variograms are displayed in the chart:

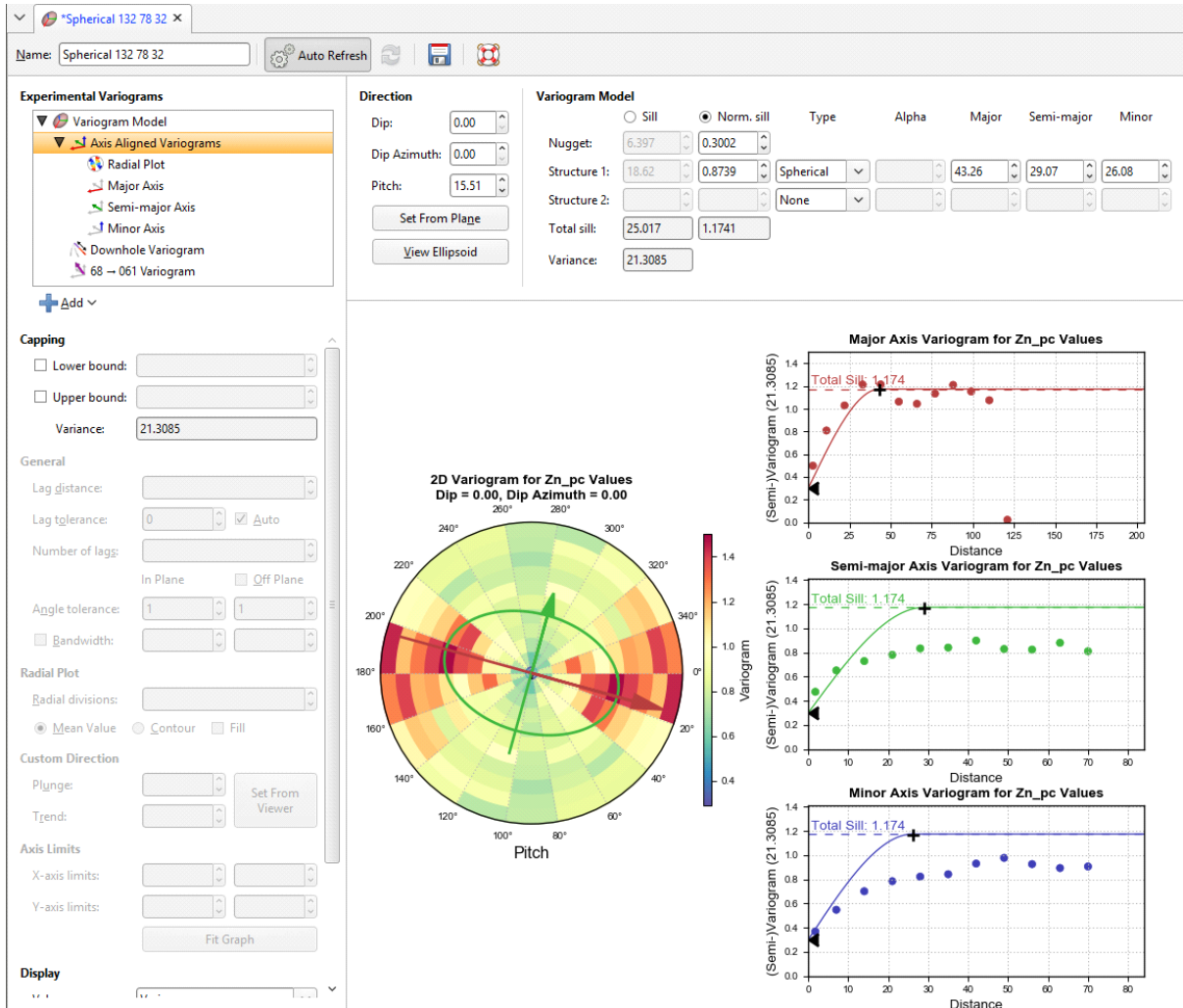

The radial plot and each of the axes variograms can be viewed in greater detail by clicking on them in the variogram tree:

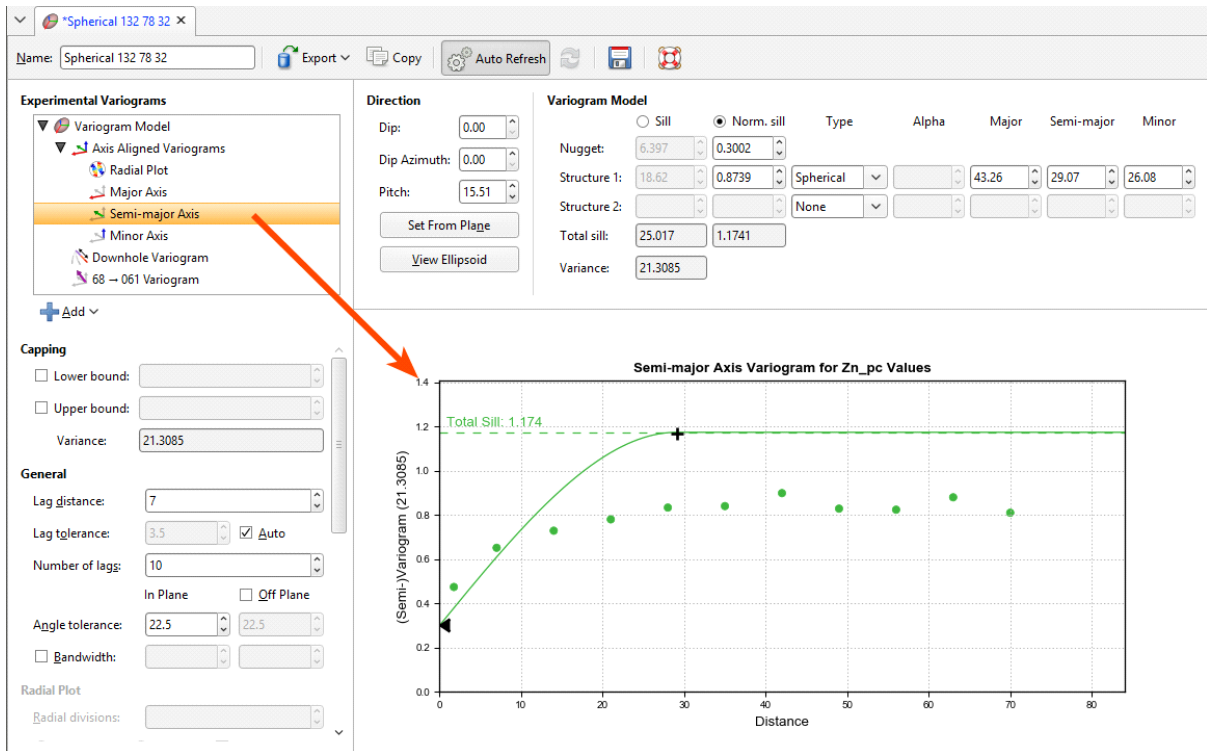

In the axes variogram plots, you can click-and-drag the plus-shaped dragger handle to adjust the range and the sill. A triangular dragger handle adjusts the nugget. A solid line shows the model variogram, and dotted horizontal lines show the **Total Sill** and, if **Sill** is chosen instead of **Norm. sill**, the variance.

In the radial plot, you can click-and-drag the axes arrows to adjust the pitch setting, between the values 0 and 180 degrees. Each bin in the mean value radial plot shows the mean semi-variogram value for pairs of points binned by direction and distance. When the contour plot is selected, lines follow the points of equal value.

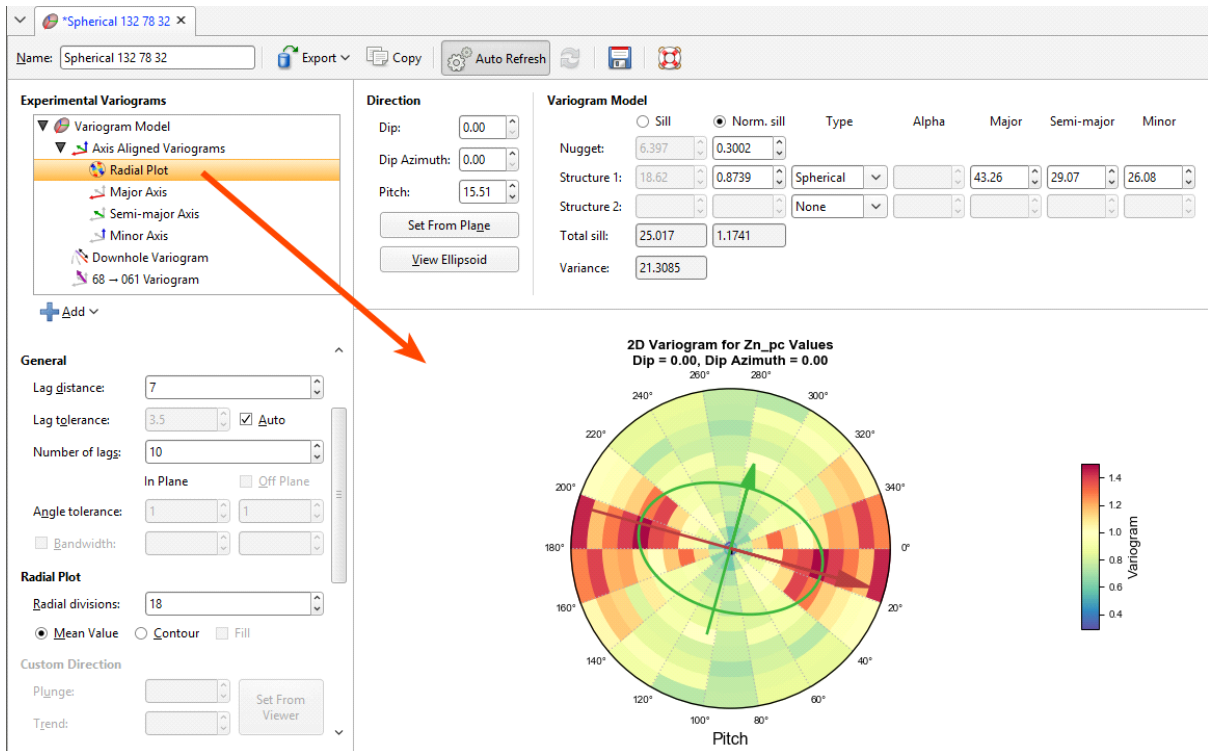

The experimental variogram controls can be different for each axis direction.

Custom Variograms

Any number of custom variograms can be created. These are useful when validating a model, for checking the variogram directions other than the axis-aligned directions. The **Plunge to Trend** settings determine the direction of the experimental variogram, and these are set independently of the **Dip**, **Dip Azimuth** and **Pitch** settings used by the other experimental variograms. The **Plunge to Trend** settings can be quickly set by orienting the scene and then clicking the **Set From Viewer** button in the **Variogram Model** window. This copies the current scene azimuth and plunge settings into the fields for the custom variogram.

When selected, the custom variogram shows a semi-variogram plot, with the model variogram plotted:

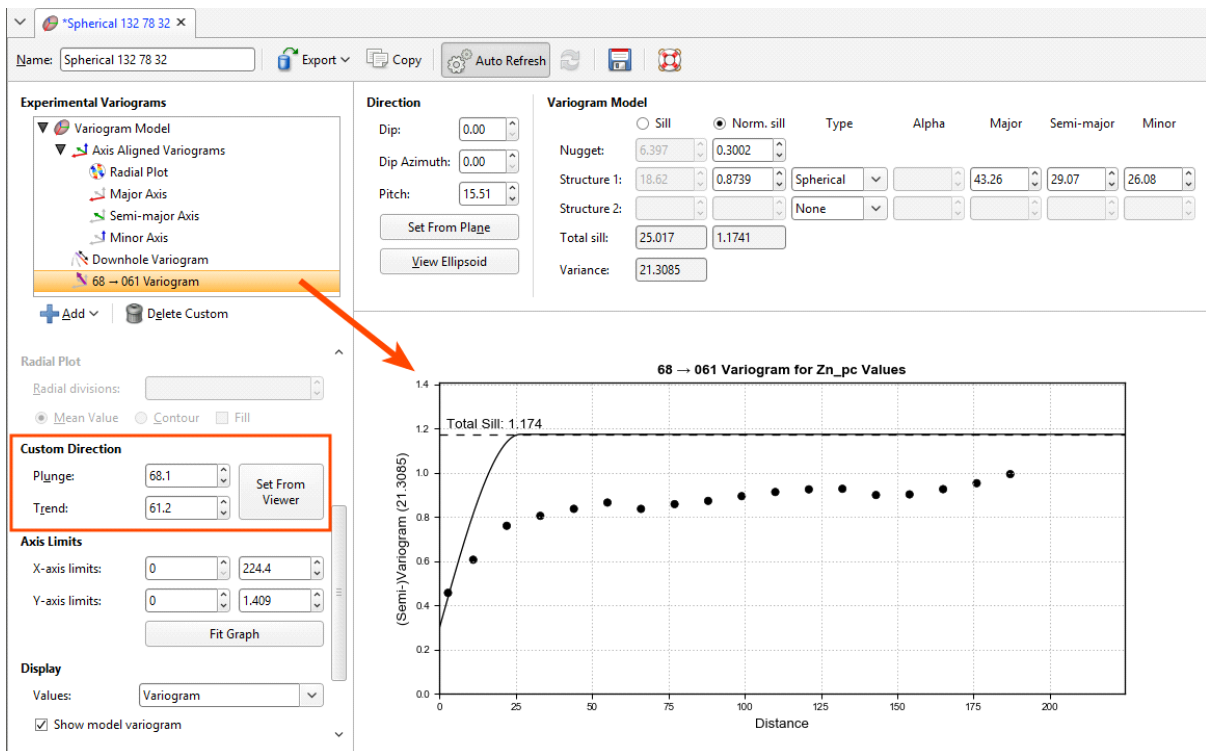

There are no handles on this chart. Dotted horizontal lines indicate the **Total Sill** and, if **Sill** is chosen instead of **Norm. sill**, the variance.

Variable Orientation

The features described in this topic are only available if you are licensed to use Leapfrog Edge with Leapfrog Geo.

The principal direction of mineralisation can change across a domain, such as when the domain features an undulating, gently-folded structure. Using a single fixed orientation for the sample search and the variogram can result in poor sample selection and weighting locally. Using a variable orientation makes it possible to re-orient the search and variogram according to local characteristics, which results in improved local grade estimates. For example, here a variable orientation has been created using a stratigraphic sequence; disks indicate the local search space orientation and are coloured with the dip direction. The output volume of the geological model is shown for context.

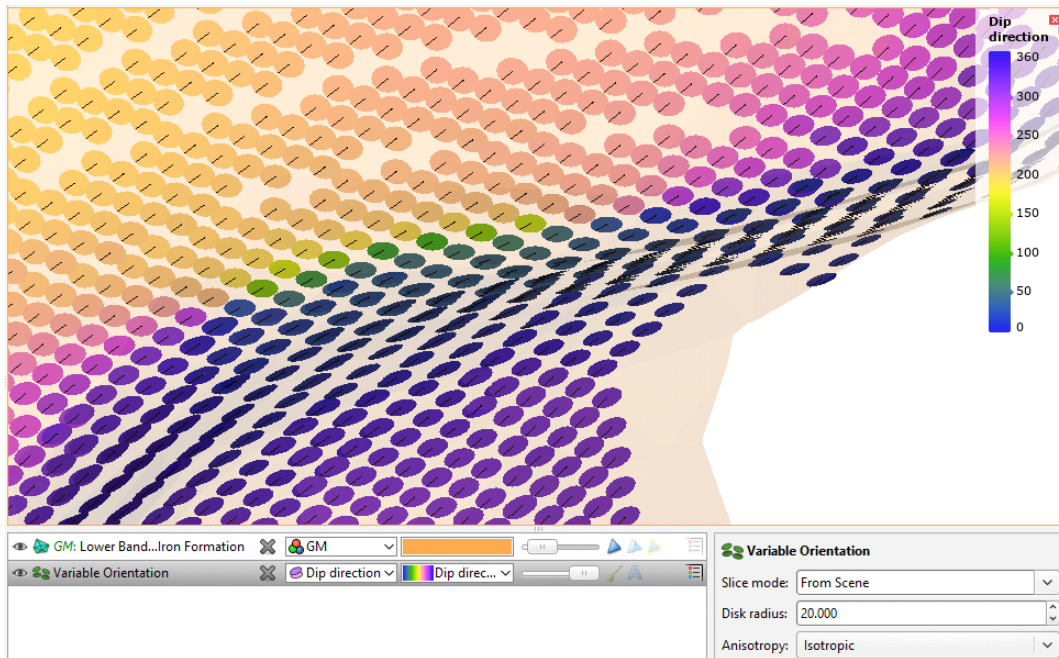

Variable orientations can have multiple inputs, including veins, the contact surfaces in a stratigraphic sequence and any mesh in the project.

A variable orientation can be applied to Kriging and inverse distance estimators. You can make as many variable orientations as you wish for each domained estimation, which allows you to experiment with a wide variety of scenarios.

Variable orientations cannot be used with RBF estimators, but RBF estimators can use structural trends.

The rest of this topic describes how to create and work with variable orientations. It is divided into:

- [Visualisation Options for Variable Orientations](#)
- [Creating Variable Orientations](#)
- [The Variable Orientation in the Project Tree](#)
- [Applying a Variable Orientation](#)
- [Exporting Rotations](#)

Visualisation Options for Variable Orientations

Variable orientations can be viewed as disks or lines. The grid used for visualisation can be any block model or sub-blocked model in the project or a custom grid can be specified as part of setting up the variable orientation.

Here a variable orientation is visualised on a custom grid, with disks coloured using the **Dip direction** values at each point on the grid. Enabling text display (A) shows the values in the scene. The plane of the disks is oriented to match the major-intermediate plane of the local search space ellipsoid orientation calculated for the centroid. The line on each disk indicates the position and direction of the major axis.

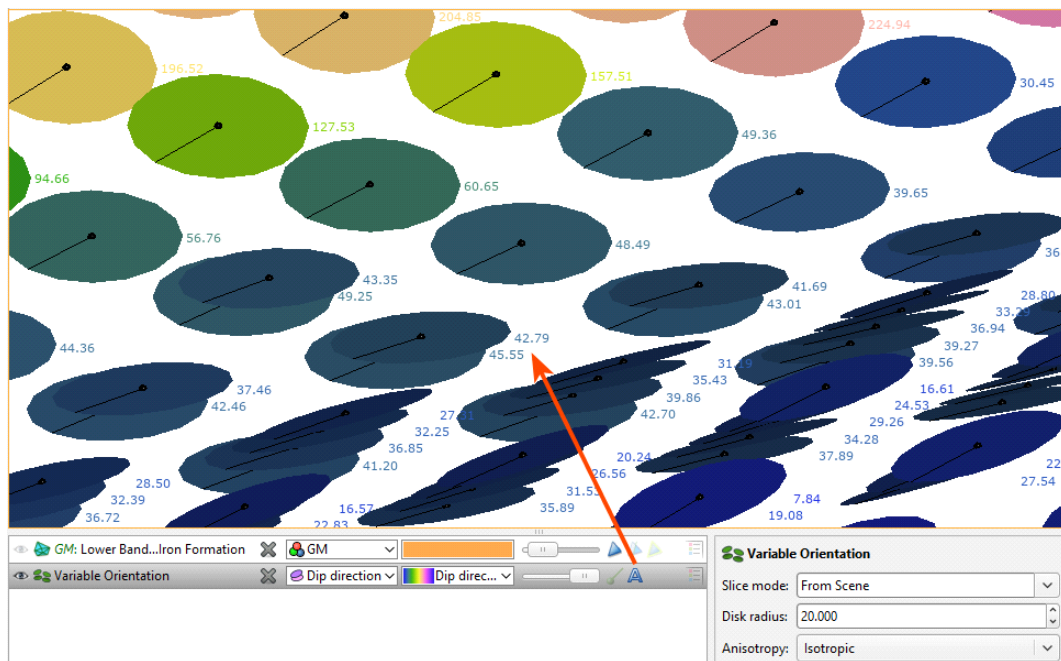

Click on a disk to view further information about it.

There is also the **Show as lines** option (✓), which hides the disks to reduce visual clutter while still showing the fundamental orientation information in the form of the major axis direction for each search space local to each centroid:

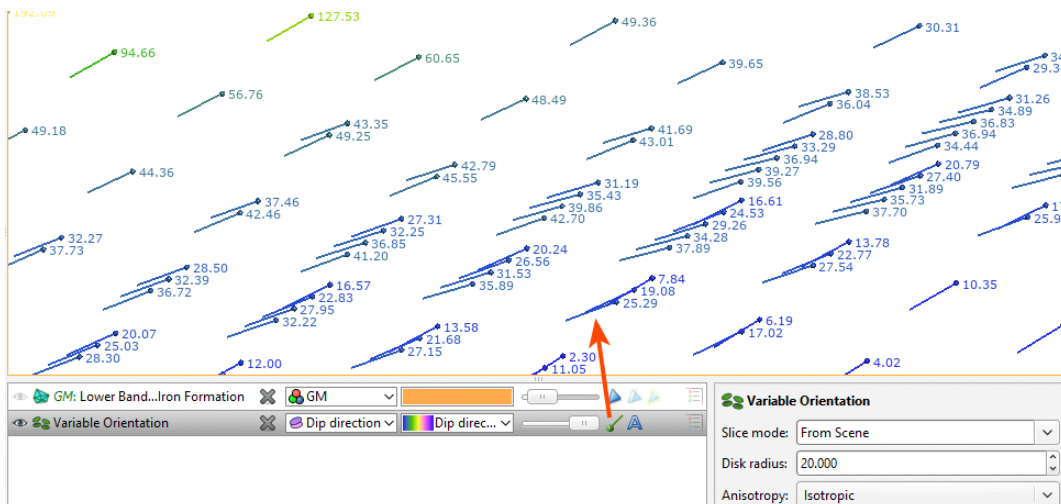

You can also change the **Anisotropy** used to display the variable orientation. Options are **Isotropic** and any variogram models and search spaces defined in the domained estimation:

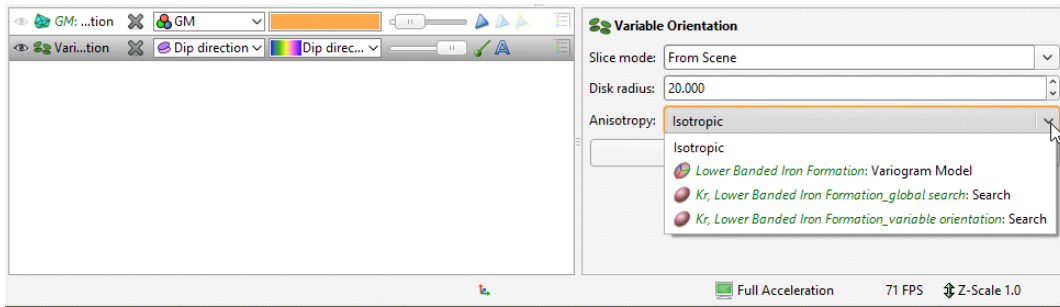

Creating Variable Orientations

Variable orientations are created on a per-domained estimation basis. You can copy variable orientations and make adjustments to them, but you cannot copy them to another domained estimation.

To create a variable orientation, right-click on the domained estimation’s **Variable Orientation** folder and select **New Variable Orientation. Inputs** and the **Global Plunge** are set in the **General** tab, and how the variable orientation will be displayed is set up in the **Visualisation** tab.

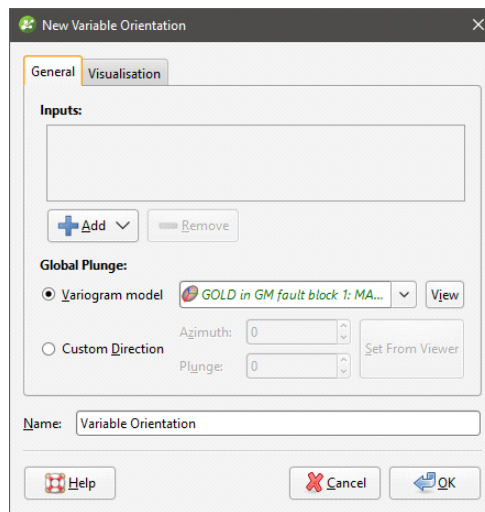

Selecting the Inputs

Inputs to a variable orientation can include veins, a stratigraphic sequence and any mesh in the project. When a mesh is used, it should be an open mesh that draws out the shape of the undulations of the structure, rather than a closed mesh such as the domain. Each vertex of the mesh is used to generate the orientation, so the resolution of the mesh should be sufficient to capture subtle changes in trend without adversely increasing processing time.

Using the mesh of the domained estimation is not advised. Doing so may result in boundary effects and inconsistent vector orientations, and the vector may become undefined in the middle of a mesh if components interpolate to zero.

The inputs are converted to surface normals that indicate the minor axis direction for the orientation. An important consideration in achieving a reasonable result is inputs that have consistently oriented normals.

- When multiple meshes are used, you need to ensure that the meshes are consistently oriented.
- Veins and stratigraphic sequences are made up of multiple surfaces, and the normals for these surfaces are combined into a single cloud of normal vectors.
 - When a vein is used as an input, the hangingwall and footwall surfaces are used. To make normal directions consistent, the hangingwall normals are flipped to point in the same direction as the footwall normals. Common vertices in the footwall and hangingwall, where the vein pinches out, produce duplicate locations with slightly different normals. The two normals at these locations are averaged to give a single normal vector for that location.
 - When a stratigraphic sequence is used, each point of each contact surface produces a normal vector.

The cloud of normals is interpolated to produce a vector field interpolant, using separate interpolants for the X, Y and Z components of vectors.

Setting the Global Plunge

The **Global Plunge** defines the direction of maximum continuity and is used to transform the vector field interpolant calculated from the inputs into an interpolant that specifies the orientation of all three axes. The maximum and intermediate axes lie in a plane perpendicular to the minimum axis and are oriented in this plane such that the maximum axis points as close as possible to the global plunge. This is achieved by defining the maximum axis direction to be the component of the global plunge lying perpendicular to the evaluated minimum direction.

You have two choices for the **Global Plunge**:

- Use one of the variogram models defined for the domained estimation. Select one from the dropdown list.
- Set a **Custom Direction**. Click and drag in the scene to align the view, then click **Set From Viewer**.

Setting Visualisation Options

In the **Visualisation** tab, you can choose between visualising the variable orientation on an existing block model or on a custom grid. Here a variable orientation created from a vein is visualised on a block model:

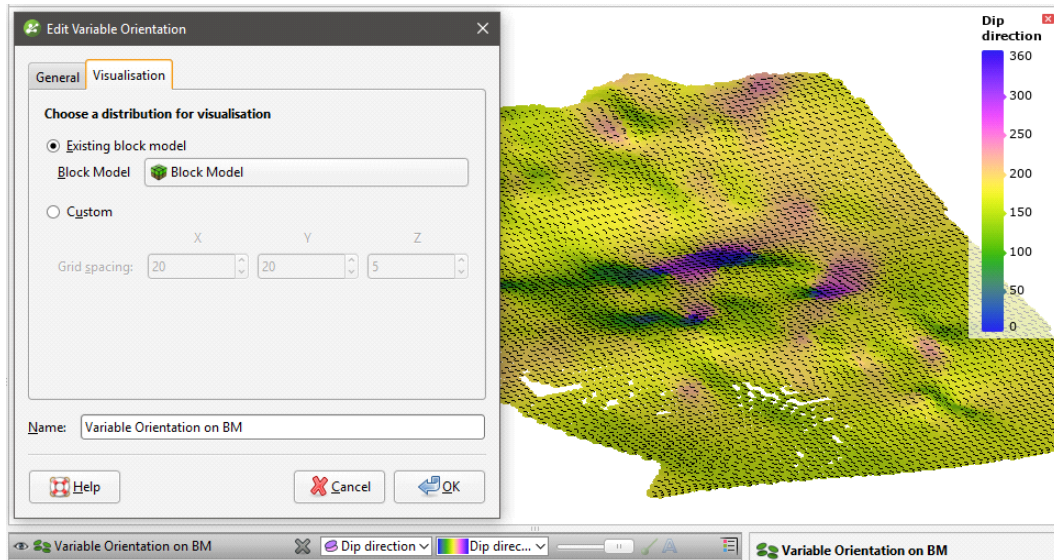

Using a block model or sub-blocked model for visualisation does not evaluate the variable orientation on the selected model. All block models and sub-blocked models in the project can be selected.

Here a variable orientation created from a stratigraphic sequence is visualised on a **Custom Grid**:

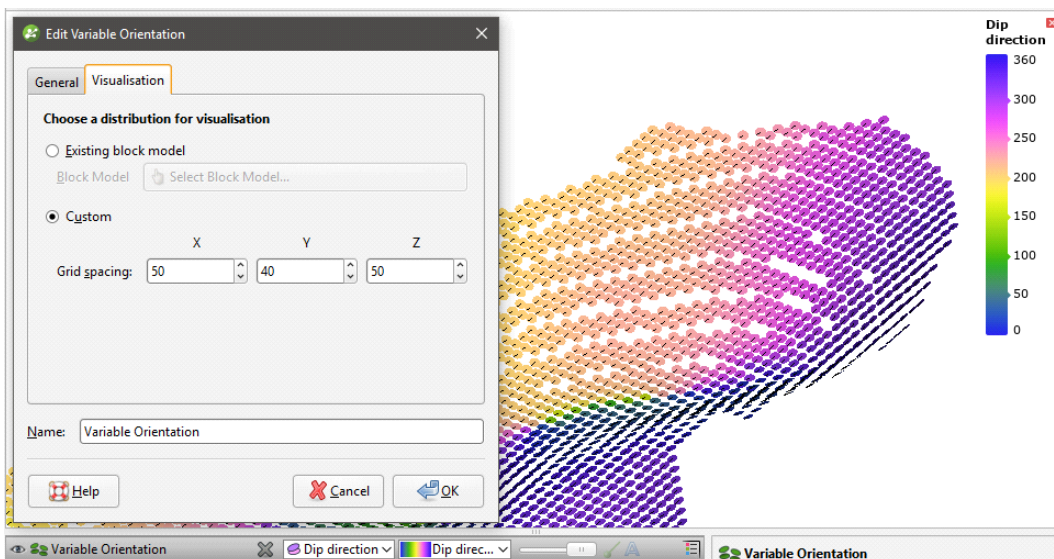

See [Visualisation Options for Variable Orientations](#) for more information on displaying the variable orientation.

The Variable Orientation in the Project Tree

Enter a name for the variable orientation and click **OK** to create it. It will be added to the project tree in the **Variable Orientation** folder. Expand it to see its parts:

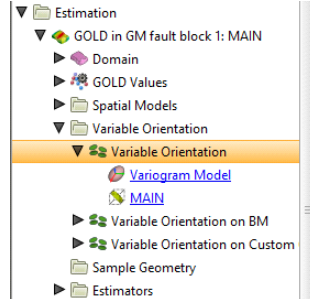

The variable orientation includes links to the variogram model, if used, and to the inputs. Drag the variable orientation into the scene to check it, and double-click on the variable orientation in the tree to edit it.

You can make multiple copies of a variable orientation, but you cannot copy them to another domained estimation.

Applying a Variable Orientation

Leapfrog Geo supports variable orientations in Kriging and inverse distance estimators. Double-click on the estimator, then click on its **Ellipsoid** tab. Tick the box for **Variable Orientation** and select from those available for the domained estimation:

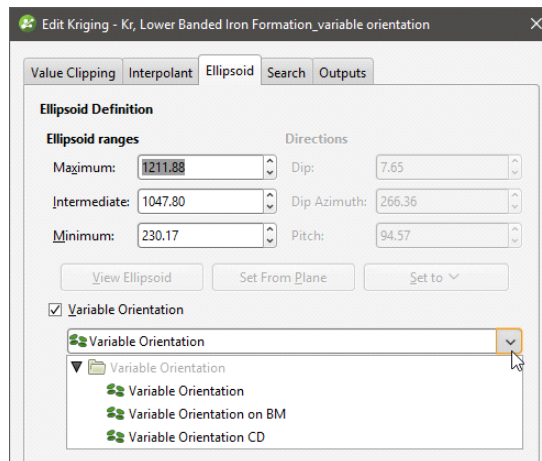

When a variable orientation is applied to an estimator, the local search can be visualised using the block model interrogation tool.

Here one block in a block model is shown with the search area indicated by the ellipsoid widget. The orientation of the ellipsoid reflects the direction set by variable orientation for this block:

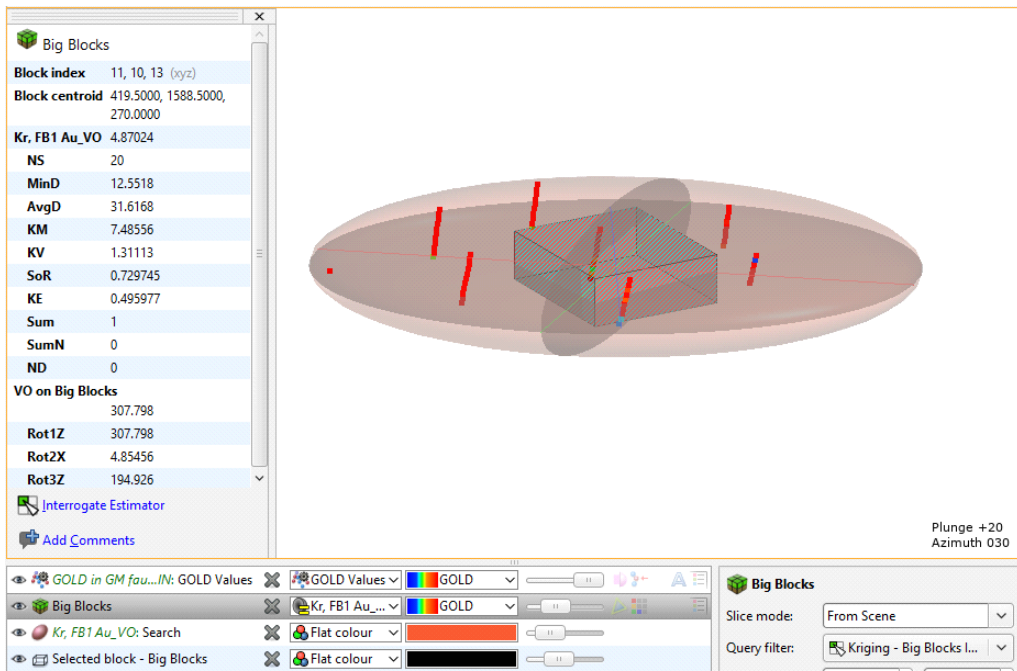

Here the viewing angle is the same but a nearby block is selected, showing a different orientation for the widget. This reflects the effect of the variable orientation on this block, demonstrating that each block can have a different search space orientation:

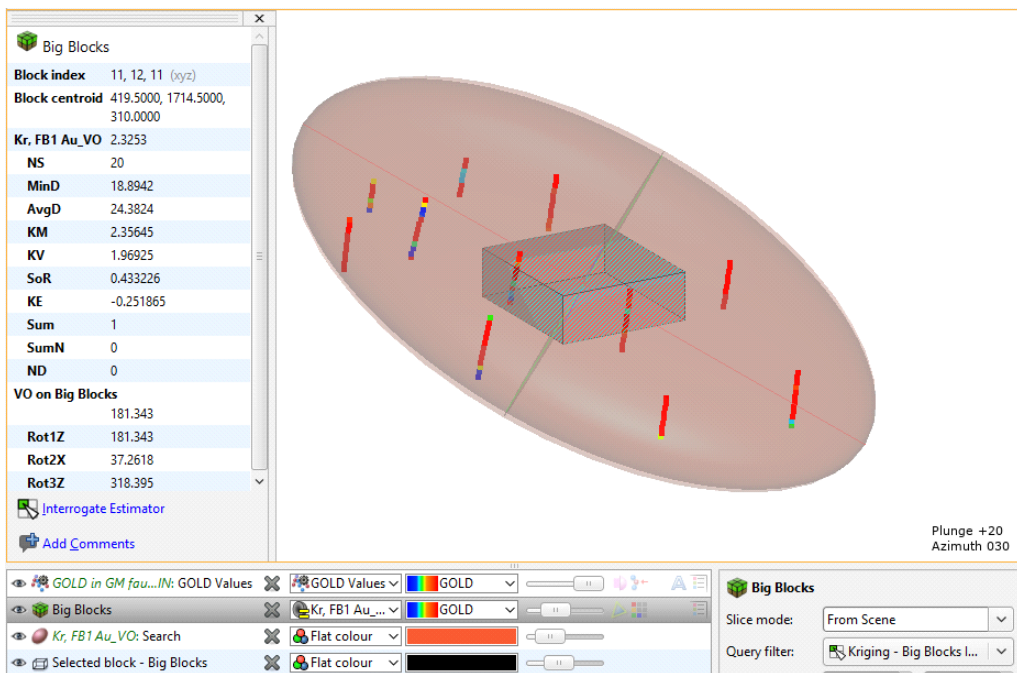

See [Block Estimate Interrogation](#) for more information on the interrogation tool.

Exporting Rotations

When you evaluate a variable orientation onto a sub-blocked model, you can use the parent block centroids or the sub-block centroids. The default setting is to evaluate onto the parent block centroids:

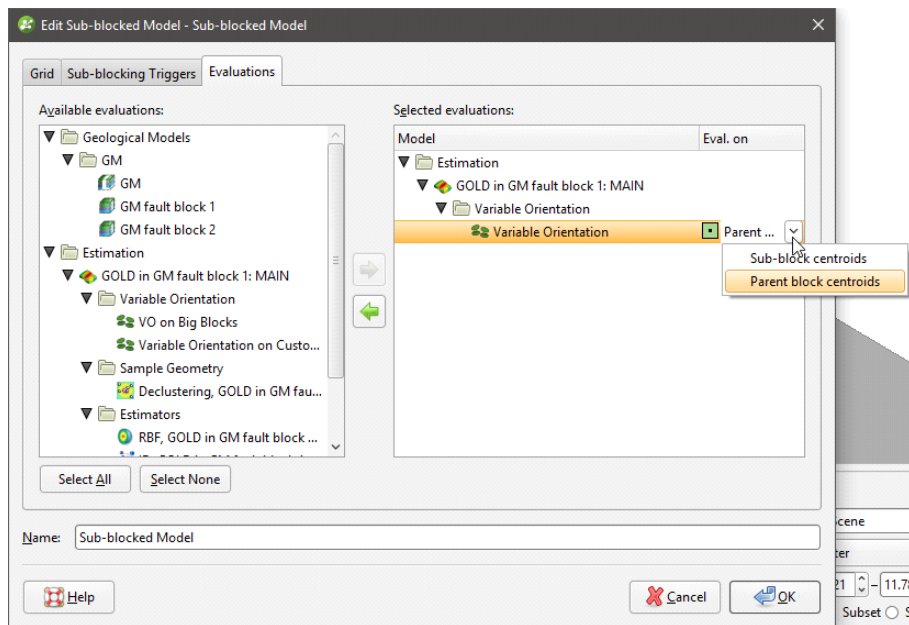

When a variable orientation is evaluated onto a block model or sub-blocked model, the **Dip Direction** and **Dip** in the variable orientation are represented in the rotation using the ZXZ convention. **Rot1Z** is the value of the rotation about the z axis. This turns y into y' and x into x', which is equivalent to the **Dip Direction** in the variable orientation:

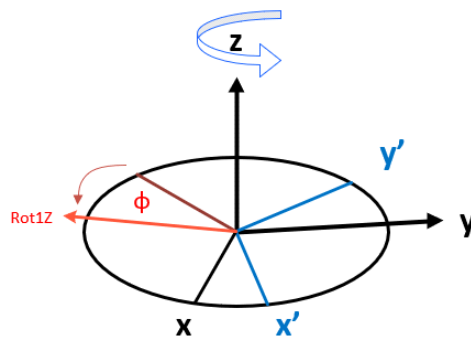

Rot2X is the value of the rotation about the x' axis and is equivalent to **Dip**:

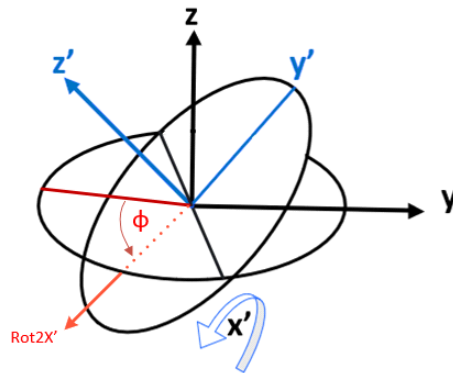

When a variable orientation is evaluated onto a block model or sub-blocked model, you can click on a block to view the rotation information:

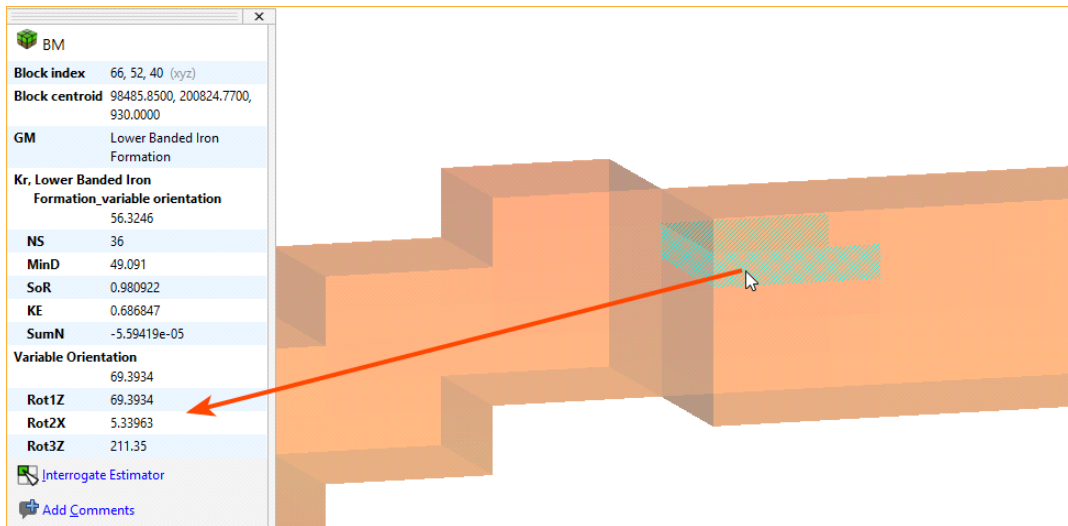

You can right-click on the evaluation in the project tree to view its statistics:

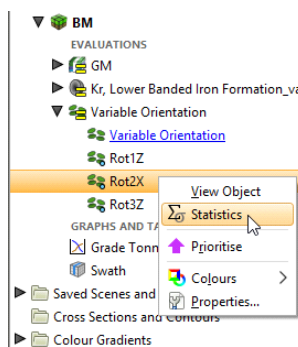

For example, here the histogram is displayed for the **Rot2X** values. **Rot2X** varies throughout the surface, indicating that a global trend would not adequately describe the characteristics of surface. The variable orientation is displayed in the scene, along with selected blocks from the block model where the **Rot2X** values are selected in the histogram. They are highlighted in the scene, indicating the parts of the variable orientation that have the steepest dip:

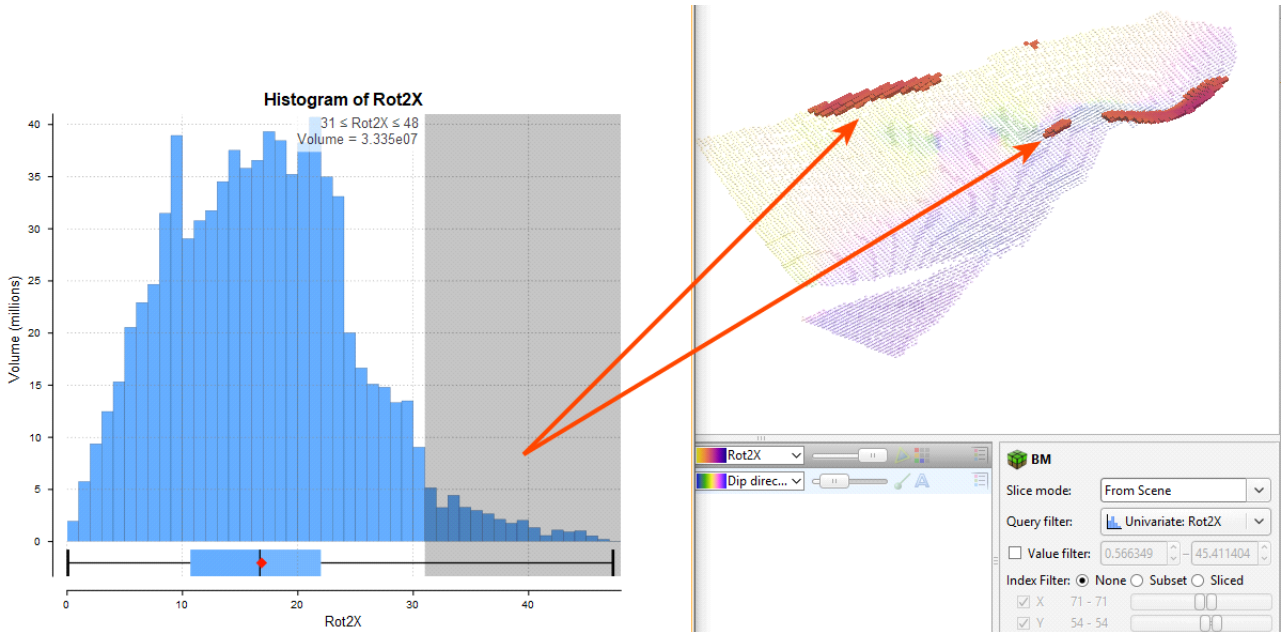

If required, you can export the rotations for use in other packages. When exporting the block model, be sure to select the variable orientation evaluation:

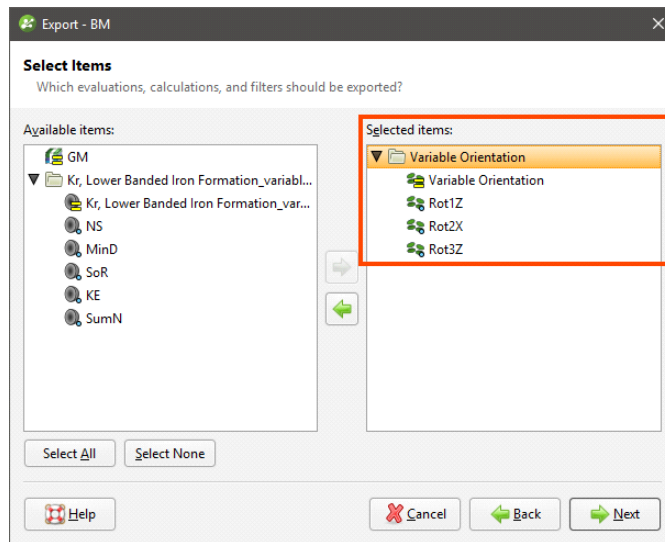

Sample Geometries

The features described in this topic are only available if you are licensed to use Leapfrog Edge with Leapfrog Geo.

This topic describes the declustering object available in the **Sample Geometry** folder. This topic is divided into:

- [Creating a New Declustering Object](#)
- [The Declustering Object in the Project Tree](#)
- [Applying a Declustering Object](#)

The declustering object is a tool for calculating local sample density. It can be used to provide confidence in an estimate, a value for determining boundaries, or a declustering weight that can be used to remove sampling bias from a set of values. Common traditional techniques for declustering utilise a grid or polygonal cells.

In Leapfrog Geo, the declustering object is used to calculate declustering weights that are inversely proportional to the data density at each sample point. A declustering object can be used by an inverse distance estimator.

Creating a New Declustering Object

To create a new declustering object, right-click on the **Sample Geometry** folder and select **New Declustering Object**. The **New Declustering Object** window will appear and an ellipsoid will be added to the scene:

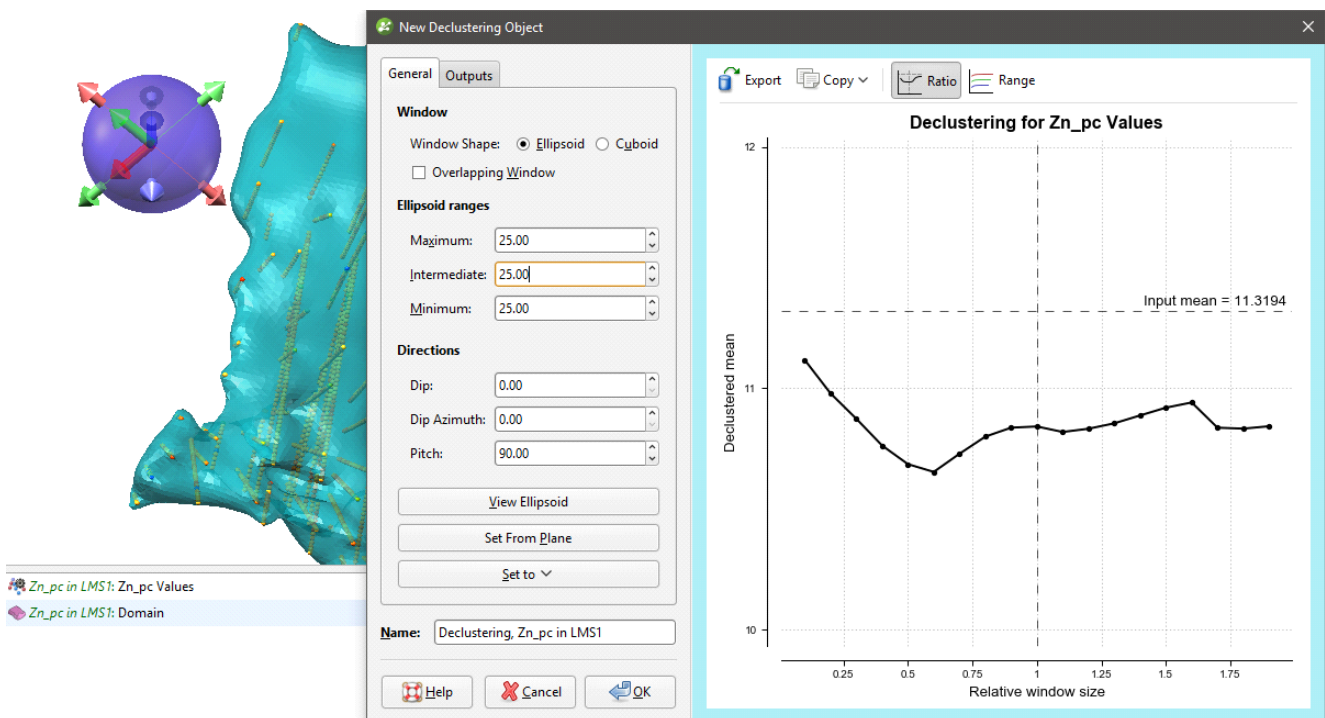

The ellipsoid has two sets of handles; click on the ellipsoid to toggle between them. The red, green and blue arrow set on the outer edge is for setting the **Ellipsoid Ranges**. The yellow, blue and red set of arrows on the outer edge is for setting the **Directions**.

In the middle will either be another set of red, green and blue arrows for repositioning the widget along the scene axes, or a set of orange arrows for repositioning the widget along the camera's perspective of the screen plane. Once the declustering object has been created, you

will be able to switch between these using the **Align movement handles to Axes** or **Camera** options in the properties panel.

On the right side of the **New Declustering Object** window is a declustering chart. This is used to guide the selection of settings for the declustering object, particularly the ranges for the search ellipsoid. There are two chart views. The default view, **Ratio**, shows a chart of the declustered mean against relative window size:

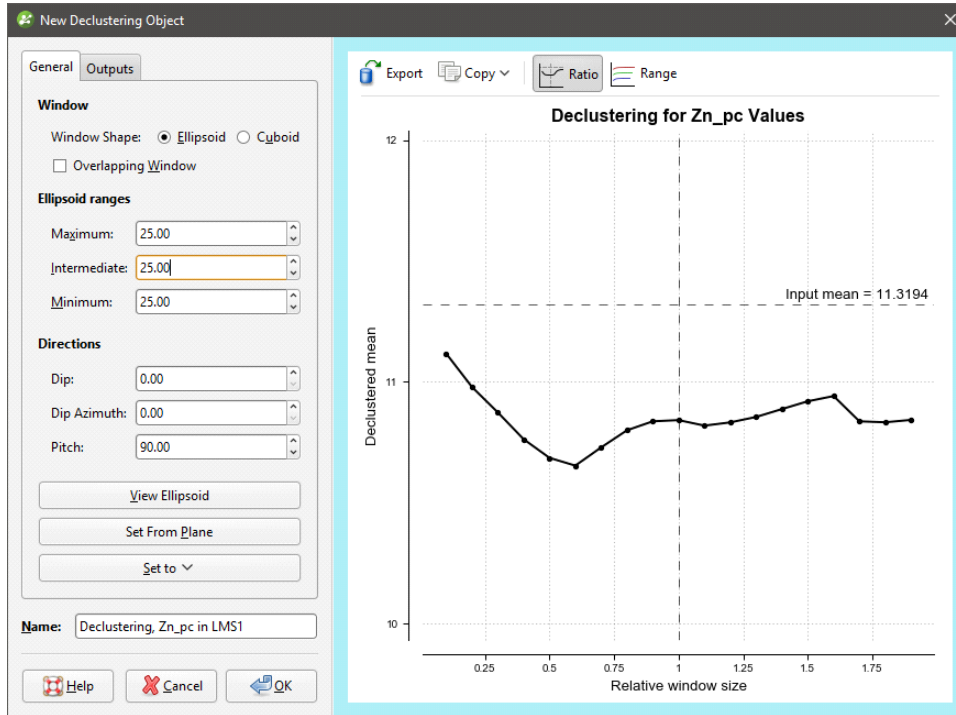

Range shows three declustering charts, one for each axis of the search ellipsoid:

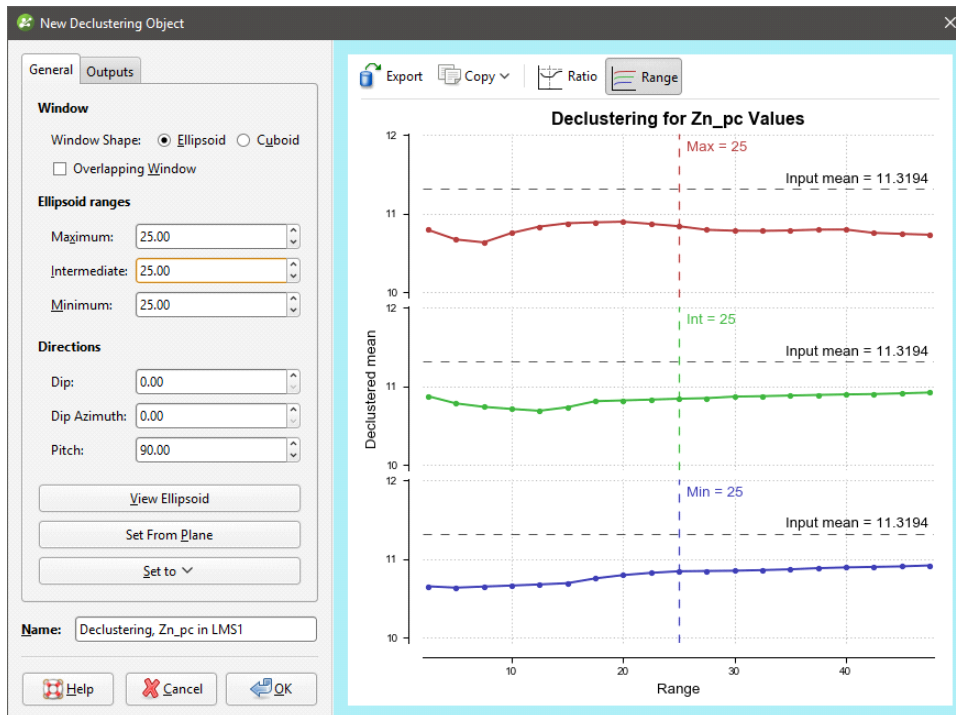

All charts indicate the naïve mean using a dotted horizontal line.

You can interact with the charts by dragging the dotted vertical line to the left or right. In the **Ratio** view, this changes the current ellipsoid range settings by a proportional ratio, as indicated on the x-axis of the chart. In the **Range** view, the selected range setting is updated accordingly. Select a place on the chart that minimises the effect of declustering on the mean of the data, where the range is close to the naïve mean and where there is no significant jump in the data. Changes made to the declustering options are reflected automatically in the selected chart. Above the chart are some export options. The **Export** button saves the declustering chart as either a PDF, SVG or PNG file based on your selection. **Copy > Copy Graph Image** saves an image to the operating system clipboard at the selected resolution. You can then paste the image into another application.

General Settings

The **General** tab of the **New Declustering Object** window is divided into three parts, **Window**, **Ellipsoid Ranges** and **Directions**.

The **Window** section defines the declustering object's shape:

- The **Window Shape** can be **Ellipsoid** or **Cuboid**. Select **Cuboid** to approximate traditional grid declustering. The **Ellipsoid** option avoids increased density values for sampling oriented away from axes.
- The **Overlapping Window** option acts similarly to a rolling average by moving the window incrementally in overlapping steps, providing a much smoother result.
 - Disabling **Overlapping Window** approximates a traditional grid behaviour; a single fixed window is used around each evaluation location and the density is simply the count of all input points within the window.
 - Enabling **Overlapping Window** implicitly averages the point count over all possible windows that contain the evaluation location.

The **Ellipsoid Ranges** settings provide the same anisotropy controls used elsewhere in Leapfrog Geo, determining the relative shape and strength of the ellipsoid in the scene. Including them here provides additional advantages over traditional grid declustering.

- The **Maximum** value is the range in the direction of the major axis of the ellipsoid.
- The **Intermediate** value is the range in the direction of the semi-major axis of the ellipsoid.
- The **Minimum** value is the range in the direction of the minor axis of the ellipsoid.

In the scene window, the ellipsoid's outer red, green and blue handles adjust the **Ellipsoid Ranges**.

The **Directions** settings determine the orientation of the ellipsoid in the scene, where:

- **Dip** and **Dip Azimuth** set the orientation of the plane for the major and semi-major axes of the ellipsoid. **Dip** is the angle off the horizontal of the plane, and **Dip Azimuth** is the compass direction of the dip.
- **Pitch** is the angle of the ellipsoid's major axis on the plane defined by the **Dip** and **Dip Azimuth**. When **Pitch** is 0, the major axis is perpendicular to the **Dip Azimuth**. As **Pitch** increases, the major axis points further down the plane towards the **Dip Azimuth**.

In the **Scene View**, the ellipsoid's yellow, blue and red handles adjust the **Directions**.

The moving plane can also be useful in setting the anisotropy **Directions**. Add the moving plane to the scene, and adjust it using its controls. Then click the **Set From Plane** button to populate the **Dip**, **Dip Azimuth** and **Pitch** settings.

You can also use the **Set to** list to choose different from the variogram models available in the project.

To approximate grid declustering, set the **Window Shape** to **Cuboid**, disable the **Moving Window** and set the **Maximum**, **Intermed.** and **Minimum** ranges to be equal values.

Outputs

The **Outputs** tab of the **New Declustering Object** window features **Attributes to calculate**. **Value** and **Status** will always be calculated, but you can optionally include **NS** (number of samples), **MinD** (distance to closest sample) or **AvgD** (average distance to sample).

The Declustering Object in the Project Tree

Enter a name for the declustering object and click **OK** to create it. It will be added to the project tree in the **Sample Geometry** folder. Expand it to see its parts, which can be individually added to the scene:

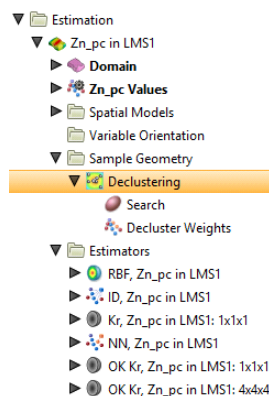

Double-click on the declustering object in the tree to edit it.

Export the declustering weights by right-clicking on the values object in the project tree and selecting **Export**.

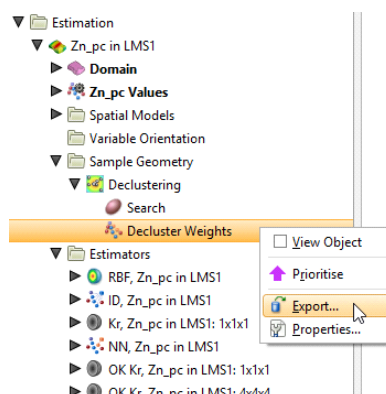

Applying a Declustering Object

Leapfrog Geo supports declustering in the inverse distance estimator. To decluster data, select a declustering object from the **Declustering** dropdown list:

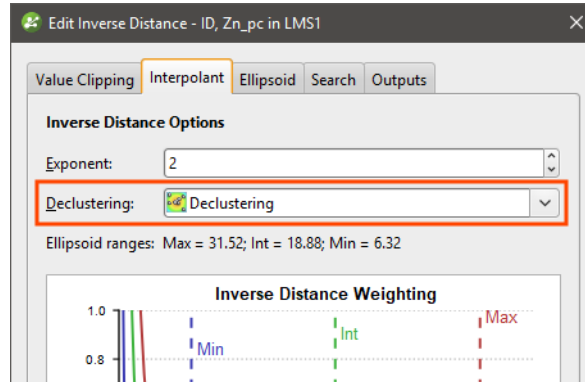

When no declustering object is selected, the inverse distance estimator is the standard inverse distance weighted method.

Estimators

The features described in this topic are only available if you are licensed to use Leapfrog Edge with Leapfrog Geo.

Leapfrog Geo supports the following estimator functions:

- Inverse distance
- Nearest neighbour
- Ordinary and simple Kriging
- RBF (Radial Basis Function)

This topic describes creating and working with the different types of estimators. It is divided into:

- [Inverse Distance Estimators](#)
- [Nearest Neighbour Estimators](#)
- [Kriging Estimators](#)
- [RBF Estimators](#)

Estimators can be copied, which makes it easy to experiment with different parameters. Simply right-click on the estimator in the project tree and select **Copy**.

Inverse Distance Estimators

The basic inverse distance estimator makes an estimate by an average of nearby samples weighted by their distance to the estimation point. The further a data point is from the estimate

location, the less it will be relevant to the estimate and a lower weight is used when calculating the weighted mean.

To create an inverse distance estimator, right-click on the **Estimators** folder and select **New Inverse Distance Estimator**. The **New Inverse Distance** window will appear:

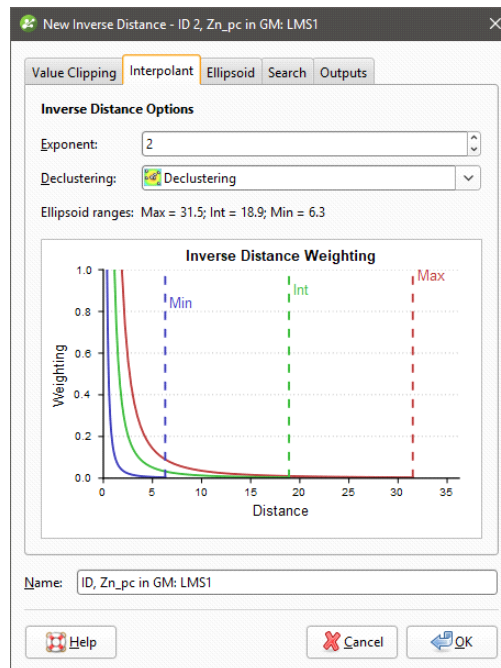

Leapfrog Geo extends the basic inverse distance function, and the inverse distance estimator supports declustering and anisotropic distance.

In the **Interpolant** tab:

- **Exponent** adjusts the strength of the weighting as distance increases. A higher exponent will result in a weaker weight for the same distance.
- Optionally select a **Declustering** object from the declustering objects defined for the domained estimation; these are saved in the **Sample Geometry** folder.
- **Ellipsoid Ranges** identify the **Max**, **Int** and **Min** ranges set in the **Ellipsoid** tab.
- A chart depicts the resultant weights that will be applied by distance.

In the **Ellipsoid** tab:

- The **Ellipsoid Definition** sets the anisotropic distance and direction, scaling distances in three orthogonal directions proportionally to the range for each of the directions of the ellipsoid axes. This effectively makes the points in the direction of greater anisotropy appear closer and increases their weighting. Adjust the **Ellipsoid Ranges** and **Directions** to describe the anisotropic trend.

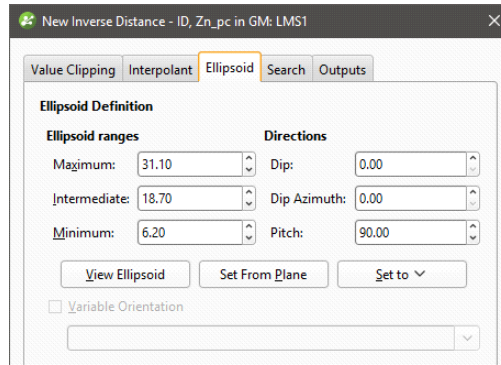

In the **Search** tab:

- The **Minimum Samples** and **Maximum Samples** parameters determine the number of samples required or used within the search neighbourhood.
- The remaining fields provide controls to reduce bias.
 - **Outlier Restriction** reduces bias by constraining the effect of high values at a distance. After ticking **Outlier Restriction**, you can choose to either **Clamp** (reduce the high value to the **Value Threshold**) or **Discard** high values that meet the criteria for outlier restrictions. It limits the samples that will be considered to those within a specified **Distance** percentage of the search ellipsoid size, and only those outside that distance if they are within the **Value Threshold**. If a sample point is beyond the **Distance** threshold and the point's value exceeds the **Value Threshold**, it will be clamped or discarded according to the option selected.
 - **Sector Search** divides the search space into sectors. Choose from **Octant** providing eight sectors or **Quadrant** providing four sectors. The **Maximum samples per sector** threshold specifies the number of samples in a sector before more distant samples are ignored. The **Maximum empty sectors** threshold specifies how many sectors can have no samples before the estimator result will be set to the non-normal value **without_grade**.
 - **Drillhole Limit** constrains how many samples from the same drillhole will be used in the search before limiting the search to the closest samples in the drillhole and looking for samples from other drillholes.

The screenshot shows a software dialog box titled "New Inverse Distance - ID, Zn_pc in GM: LMS1". It has five tabs: "Value Clipping", "Interpolant", "Ellipsoid", "Search", and "Outputs". The "Search" tab is active. Under "Search Definition", there are several sections:

- Search Definition:** "Minimum samples" is set to 4 and "Maximum samples" is set to 20.
- Outlier Restriction:** A checkbox is checked. "Clamp" is selected with a radio button, and "Discard" is unselected. "Distance (% of search)" is set to 0 and "Value threshold" is set to 0.031.
- Sector Search:** A checkbox is checked. "Octant" is selected with a radio button, and "Quadrant" is unselected. "Maximum samples per sector" is set to 1 and "Maximum empty sectors" is set to 7.
- Drillhole Limit:** A checkbox is checked. "Maximum samples per drillhole" is set to 2.

At the bottom, the "Name" field contains "ID, Zn_pc in GM: LMS1". There are "Help", "Cancel", and "OK" buttons at the bottom right.

In the **Value Clipping** tab, you can enable value clipping by ticking the **Clip input values** box. This caps values outside of the range set by the **Lower bound** and **Upper bound** to the bounding values.

In the **Outputs** tab, you can specify attributes that will be calculated when the estimator is evaluated on a block model. **Value** and **Status** attributes will always be calculated, but you can choose additional attributes that are useful to you when validating the output and reporting. These attributes are:

- The number of samples (**NS**) is the number of samples in the search space neighbourhood.
- The distance to the closest sample (**MinD**) is a cartesian (isotropic) distance rather than the ellipsoid distance.
- The average distance to sample (**AvgD**) is the average distance using cartesian (isotropic) distances rather than ellipsoid distances.
- The number of duplicates deleted (**ND**) indicates how many duplicate sample values were detected and deleted by the estimator.
- When the estimator must select from equidistant points to include or exclude in the search space because it found more samples than the **Maximum Samples** threshold, the number of equidistant points detected (**EquiD**) is recorded. You can use this output as a trigger for further investigation.

Nearest Neighbour Estimators

Nearest neighbour produces an estimate for each point by using the nearest value as a proxy for the location being estimated. There is a higher probability that the estimate for a location will be the same as the closest measured data point, than it will be for some more distance measured data point.

To create a nearest neighbour estimator, right-click on the **Estimators** folder and select **New Nearest Neighbour Estimator**. The **New Nearest Neighbour** window will appear:

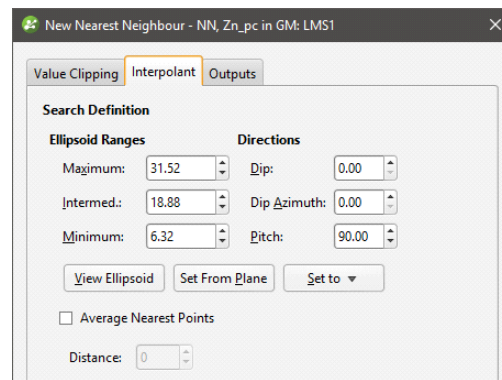

Leapfrog Geo includes support for anisotropy when determining what is considered the 'nearest' value. Adjust the **Ellipsoid Ranges** and **Directions** to describe the anisotropic trend. Additionally, the nearest neighbour estimator includes an option to **Average Nearest Points** where the ellipsoidal distance to a point is within the **Distance** tolerance of the distance to the closest point, instead of relying on a single data point. This provides a more realistic estimate when multiple points are about the same distance from the estimated point. Imagine that the point to be estimated is centred within a cluster of measured points that are all different, but almost equidistant from the estimation point. Which of these almost-equally-likely proxies should be used as the estimate? The one that is technically the closest? A better solution is to take an average of the known points and use that as the estimate.

In the **Value Clipping** tab, you can enable value clipping by ticking the **Clip input values** box. This caps values outside of the range set by the **Lower bound** and **Upper bound** to the bounding values.

In the **Outputs** tab, you can specify attributes that will be calculated when the estimator is evaluated on a block model. **Value** and **Status** attributes will always be calculated, but you can choose additional attributes that are useful to you when validating the output and reporting. These attributes are:

- The number of samples (**NS**) is the number of samples in the search space neighbourhood.
- The distance to the closest sample (**MinD**) is a cartesian (isotropic) distance rather than the ellipsoid distance.
- The average distance to sample (**AvgD**) is the average distance using cartesian (isotropic) distances rather than ellipsoid distances.

Kriging Estimators

Kriging is a well-accepted method of interpolating estimates for unknown points between measured data. Instead of the simplistic inverse distance and nearest neighbour estimates, covariances and a Gaussian process are used to produce the prediction.

To create a Kriging estimator, right-click on the **Estimators** folder and select **New Kriging Estimator**. The **New Kriging** window will appear:

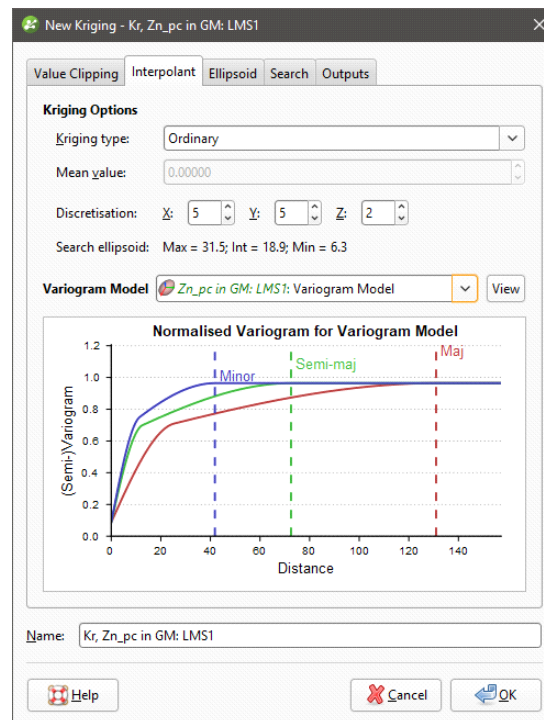

In the **Interpolant** tab:

- Both **Ordinary** and **Simple Kriging** are supported.
- For **Simple Kriging**, specify a **Mean value** for the local mean to use in the Kriging function.
- **Discretisation** sets the number of discretisation points in the **X**, **Y** and **Z** directions for block Kriging. Block Kriging provides a means of estimating the best value for a block instead of only at the centre of the block. Each block is broken down (discretised) into a number of sub-units without actually sub-blocking the blocks. A resource geologist will consider a variety of factors including spatial continuity when deciding on the discretisation to use. Set the **X**, **Y** and **Z** parameters to 1 for point Kriging. To use additional discretisations, copy the estimator and change the **Discretisation** parameters.
- **Search Ellipsoid** identifies the **Max**, **Int** and **Min** ranges set in the **Ellipsoid** tab.
- Select from the **Variogram Model** list of models defined in the **Spatial Models** folder.
- A chart depicts colour-coded semi-variograms for the variogram model.

If you select a Kriging estimator to be evaluated onto points, it will always use Point Kriging (Block Kriging with a discretisation of 1x1x1), overriding any discretisation settings specified for the Kriging estimator.

In the **Ellipsoid** tab:

- The **Ellipsoid Definition** sets the **Ellipsoid Ranges** and **Direction**.

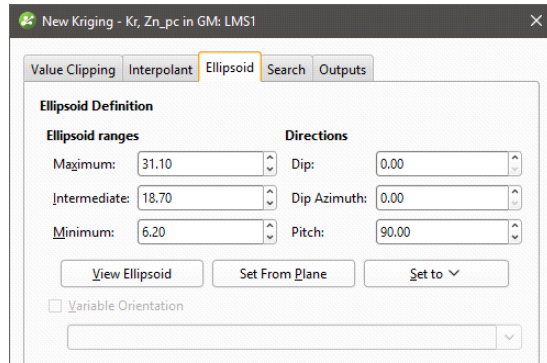

In the **Search** tab:

- The **Minimum Samples** and **Maximum Samples** parameters determine the number of samples required or used within the search neighbourhood.
- The remaining fields provide controls to reduce bias.
 - **Outlier Restriction** reduces bias by constraining the effect of high values at a distance. After ticking **Outlier Restriction**, you can choose to either **Clamp** (reduce the high value to the **Value Threshold**) or **Discard** high values that meet the criteria for outlier restrictions. It limits the samples that will be considered to those within a specified **Distance** percentage of the search ellipsoid size, and only those outside that distance if they are within the **Value Threshold**. If a sample point is beyond the **Distance** threshold and the point's value exceeds the **Value Threshold**, it will be clamped or discarded according to the option selected.
 - **Sector Search** divides the search space into sectors. Choose from **Octant** providing eight sectors or **Quadrant** providing four sectors. The **Maximum samples per sector** threshold specifies the number of samples in a sector before more distant samples are ignored. The **Maximum empty sectors** threshold specifies how many sectors can have no samples before the estimator result will be set to the non-normal value **without_grade**.
 - **Drillhole Limit** constrains how many samples from the same drillhole will be used in the search before limiting the search to the closest samples in the drillhole and looking for samples from other drillholes.

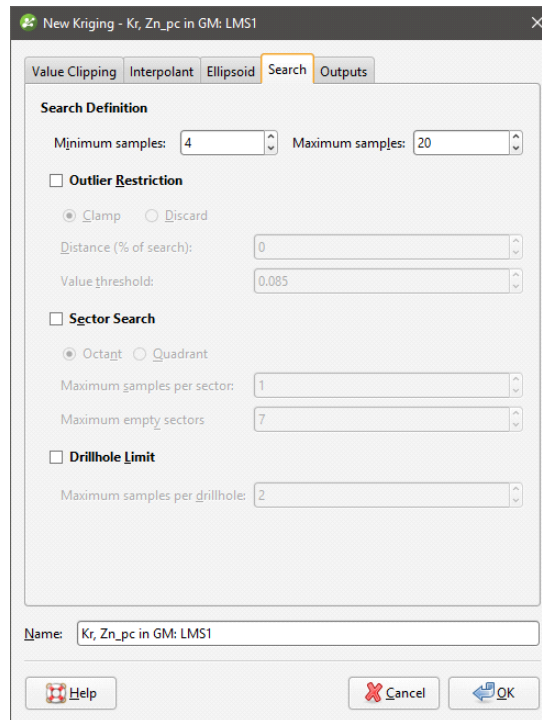

In the **Value Clipping** tab, you can enable value clipping by ticking the **Clip input values** box. This caps values outside of the range set by the **Lower bound** and **Upper bound** to the bounding values.

Kriging Attributes

In the **Outputs** tab, you can specify attributes that will be calculated when the estimator is evaluated on a block model. **Value** and **Status** attributes will always be calculated, but you can choose additional attributes that are useful to you when validating the output and reporting. These attributes are organised into two categories, **Sample properties** and **Estimation results**.

Sample properties are output attributes that relate to data sample statistics:

- The number of samples (**NS**) is the number of samples in the search space neighbourhood.
- The distance to the closest sample (**MinD**) is a cartesian (isotropic) distance rather than the ellipsoid distance.
- The average distance to sample (**AvgD**) is the average distance using cartesian (isotropic) distances rather than ellipsoid distances.
- The number of duplicates deleted (**ND**) indicates how many duplicate sample values were detected and deleted by the estimator.

Estimation results are additional information produced by the estimation:

- **Value** will always be included as it is the actual estimate result.
- **Status** will always be included as it classifies the estimation result as a **Normal** result, or non-normal **Blank**, **Without-grade**, **Outside** or **Error** result.
- The Kriging mean (**KM**) is the local mean used for the estimate based around the selected sample data. For simple Kriging, this is the specified global mean. For ordinary Kriging, it is the unknown locally constant mean that is assumed when forming the Kriging equations. This

value is only dependent on the covariance function and the sample locations and values for the chosen neighbourhood. It does not depend on the evaluation volume and therefore will be the same for block Kriging and point Kriging. It can give some indication of suitability of the assumptions when doing ordinary Kriging.

- The Kriging variance (**KV**) is important in assessing the quality of an estimate. It grows when the covariance between the samples and the point to estimate decreases. This means that when the samples are further away from the evaluation point, the quality of the estimation decreases. For simple Kriging, the value is capped by the value of the covariance between the target volume and itself. For ordinary Kriging, higher values indicate a poor value.
- The Kriging efficiency (**KE**) is calculated based on the block variance and Kriging variance (**KV**). It should be 1 when the Kriging variance is at its minimum and 0 when the Kriging variance equals the block variance.
- The slope of regression (**SoR**) is the slope of a linear regression of the actual value, knowing the estimated value. For simple Kriging it is 1 and for ordinary Kriging a value of 1 is desired as it indicates that the resulting estimate is conditionally unbiased. Conditional bias is to be avoided as it increases the chance that blocks will be misclassified when considering a cutoff grade.
- The sum of weights (**Sum**) is the sum of the Kriging weights. For ordinary Kriging, the sum is constrained to being equal to 1.
- The sum of negative weights (**SumN**) can be used to assess the quality of an estimation. Negative weights are to be avoided or at least minimised. If there are negative weights, it is possible that the estimated value may be outside the range of the sample values. If the sum of negative weights is significantly large (when compared to the total sum), then it could result in a poorly estimated value, depending on the sample values.

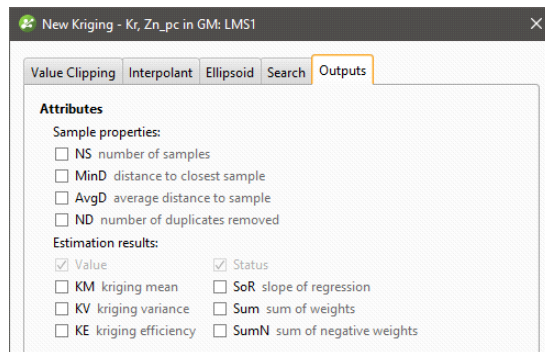

When selecting the block model evaluation to display in the 3D scene, you can select either the Kriging values, or from these additional selected attributes.

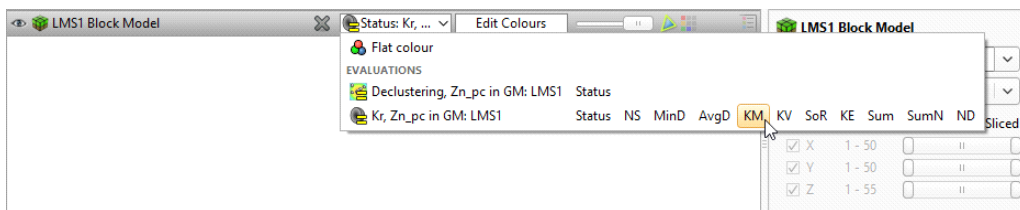

RBF Estimators

The RBF estimator brings the Radial Basis Function used elsewhere in Leapfrog into estimation. Like Kriging, RBF does not use an overly-simplified method for estimating unknown points, but produces a function that models the known data and can provide an estimate for any unknown point. Where Kriging is limited to a local search neighbourhood, RBF utilises a global neighbourhood.

To create an RBF estimator, right-click on the **Estimators** folder and select **New RBF Estimator**. The **New RBF** window will appear:

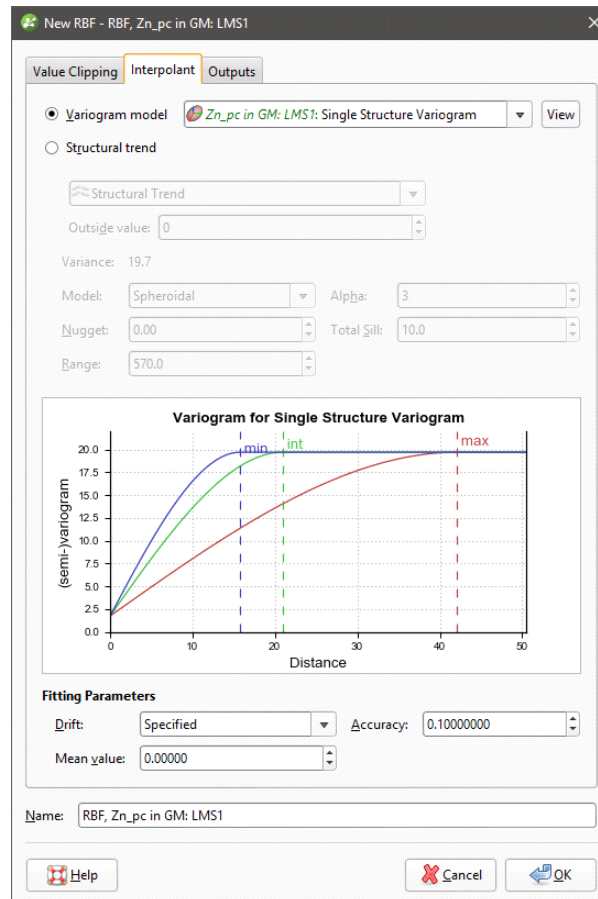

Like other estimators, a spatial model defined outside the estimator as a separate **Variogram Model** can be selected.

Alternatively, in a feature unique to RBF estimators, a **Structural trend** can be used, if one is available in the project. Set the **Outside value** at the long-range mean value of the data.

Otherwise, the RBF estimator behaves very similarly to the RBF interpolant in Leapfrog.

Drift is used to specify what the estimates should trend toward as distance increases away from data. The RBF estimator has different **Drift** options from the non-estimation RBF interpolants. The RBF estimator function offers the **Drift** options **Specified** and **Automatic**. When selecting **Specified**, provide a **Mean Value** for the trend away from data. **Automatic** is equivalent to the **Constant** option offered by non-estimation RBF interpolants, and **Linear** is not supported. **Specified** drift with a **Mean Value** of 0 is equivalent to **None**.

In the **Value Clipping** tab, you can enable value clipping by ticking the **Clip input values** box. This caps values outside of the range set by the **Lower bound** and **Upper bound** to the bounding values.

In the **Outputs** tab, the **Minimum** and **Maximum Evaluation Limits** constrain the values. Values outside the limits are set to either the minimum or maximum limit, as appropriate. To enable a limit, tick the checkbox and set a limit value.

In the **Outputs** tab, you can also define isosurfaces for an RBF estimator:

- The **Default resolution** will be used for all isosurfaces, unless you change the **Surface Resolution** setting for an individual isosurface. See [Surface Resolution in Leapfrog Geo](#) for more information on the **Adaptive** setting. The resolution can be changed once the estimator has been created, so setting a value in the **New RBF** window is not vital. A lower value will produce more detail, but calculations will take longer.
- The **Volumes enclose** option determines whether the volumes enclose **Higher Values**, **Lower Values** or **Intervals**. Again, this option can be changed once the estimator has been created.
- Click the **Restore Defaults** button to add a set of isosurfaces based on the estimator's input data.
- Use the **Add** to add a new isosurface, then set its **Iso Value**.
- Click on a surface and then on the **Remove** button to delete any surface you do not wish to generate.

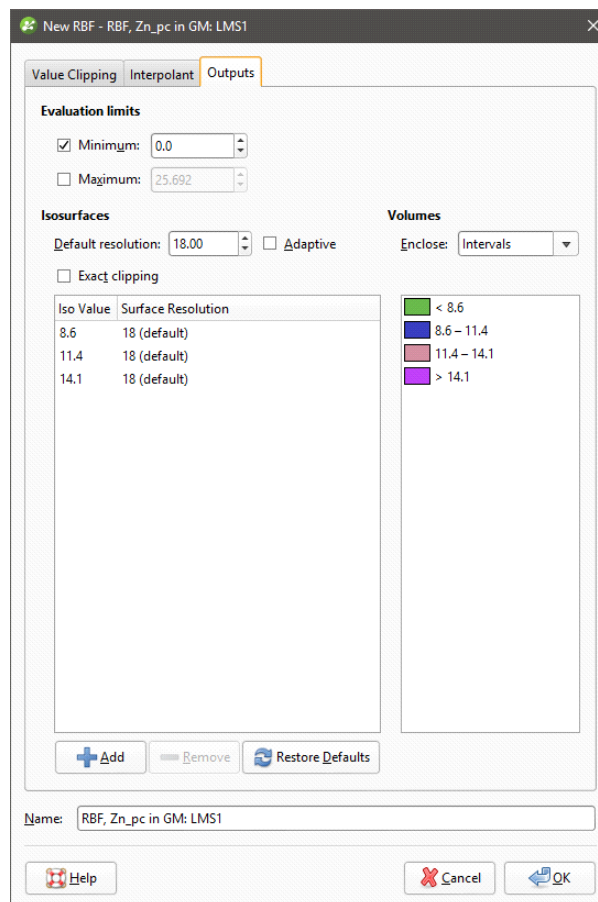

Visualising Sample Geometries and Estimators

The features described in this topic are only available if you are licensed to use Leapfrog Edge with Leapfrog Geo.

Sample geometries and estimators can be visualised by evaluating them on block models. To evaluate an estimator on a block model, right-click on the block model in the project tree and select **Evaluations**. See [Block Models](#) on how to work with the different types of block models available in Leapfrog Geo.

Calculations and filters further enhance the visualisation options, adding computational analysis and processing of data capabilities to create new types of data to visualise. To create calculations and filters, right-click on a block model in the project tree and select **Calculations and Filters**. See [Calculations and Filters on Block Models](#) for information on creating filters and building calculations.

When you select **Evaluations**, the block model's main window will be opened with the **Evaluations** tab displayed:

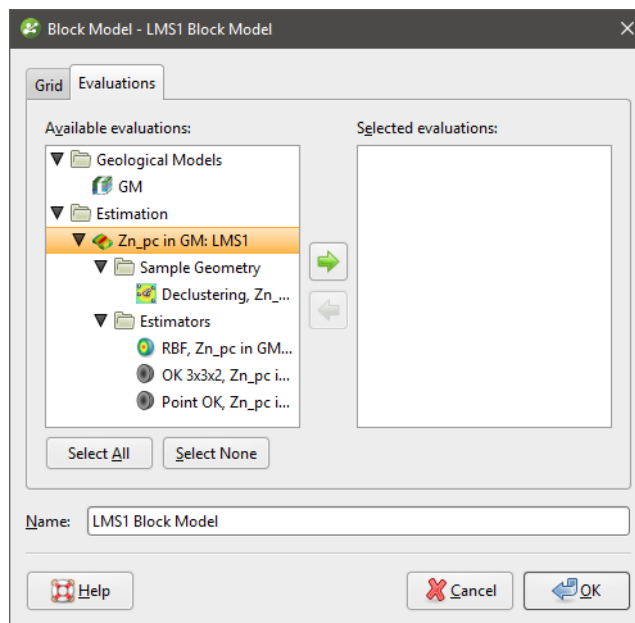

You can add all of, for example, a domained estimations sample geometries and estimators to the **Selected evaluations** list by double-clicking on the domained estimation itself.

Click **OK** to process the evaluations, which will be added to the block model in the project tree:

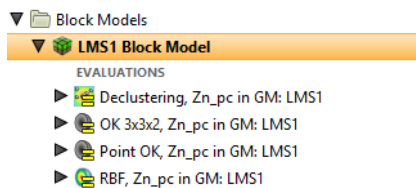

When selecting evaluations on a sub-blocked model, you can evaluate onto the parent block centroids or the sub-block centroids:

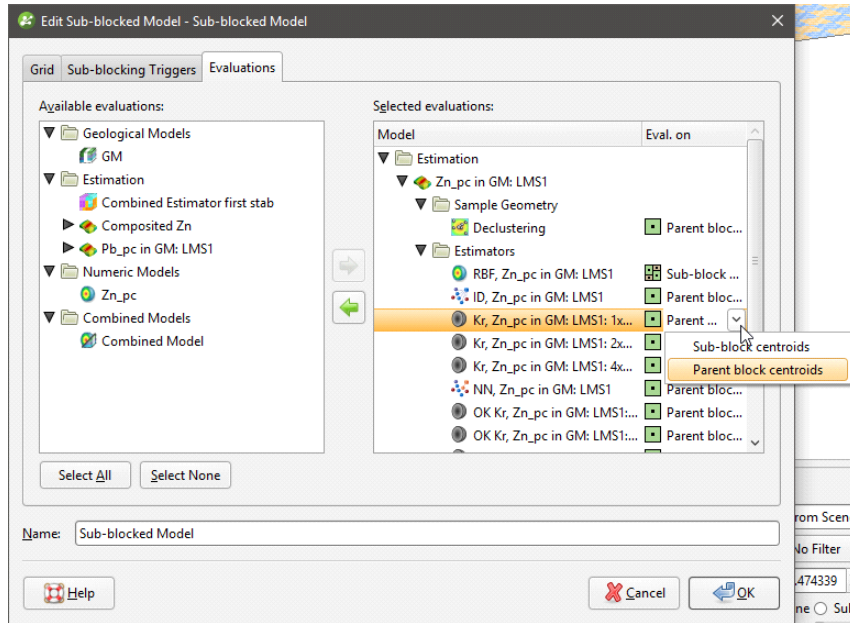

Display an evaluation by dragging it into the scene or by right-clicking on it in the project tree and selecting **View Object**.

Each evaluation will appear in the list of block model evaluations:

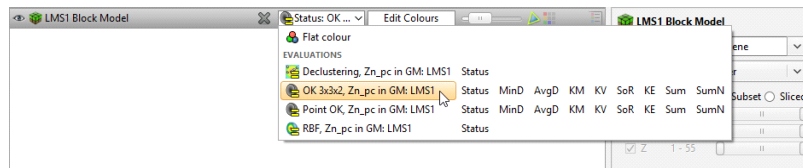

Any **Attributes** generated along with the estimator can also be displayed evaluated on the blocks:

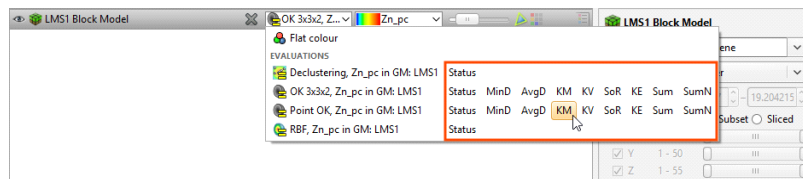

Combined Estimators

The features described in this topic are only available if you are licensed to use Leapfrog Edge with Leapfrog Geo.

Combined Estimations evaluates more than one estimation at a time on a block model. You can get a block model displaying a combined estimation showing more than one domained estimation result column or attribute.

Practical uses for this:

- To allow multiple estimation passes over the same domain, with more relaxed search criteria for subsequent passes.
- To estimate for different domains, either separate or overlapping, and evaluate them on the same block model.

By placing the estimations in a hierarchy, a preference can be indicated where different estimates are produced for the same block. Estimations lower in the hierarchy will be used when the higher-priority estimate results in a **Without Grade** or **Outside** result.

Combined Estimations works with **Kriging**, **Nearest Neighbour**, and **Inverse Distance** estimators. It does not work with **RBF** estimators. Generation of extended Kriging attributes is possible, but only when all the estimators in a combined estimation are Kriging estimators.

This topic describes creating and working with combined estimators. It is divided into:

- [Creating a Combined Estimation](#)
- [Adding Estimators to a Combined Estimation](#)
- [Evaluating a Combined Estimation](#)
- [Viewing Statistics](#)
- [Copying a Combined Estimation](#)

Creating a Combined Estimation

To create a combined estimation, right-click on the **Estimation** folder and select **New Combined Estimation**. The **New Combined Estimator** window will be displayed:

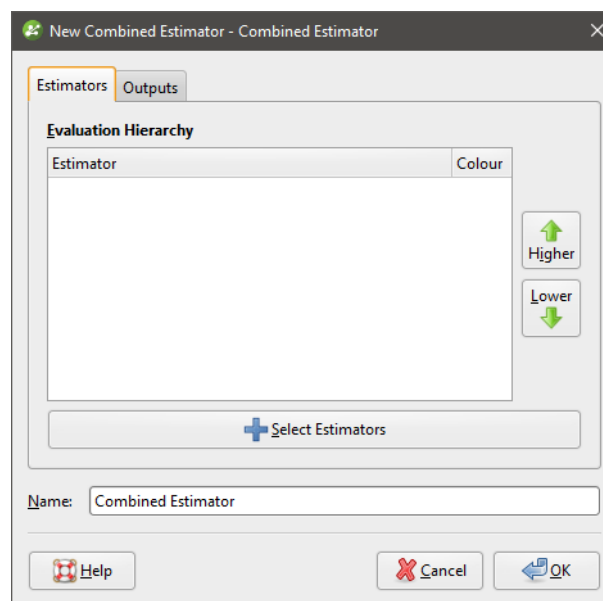

This window is divided into two tabs:

- **Estimators**
- **Outputs**

Adding Estimators to a Combined Estimation

Click the **Select Estimators** button below the **Evaluation Hierarchy**. In the **Select Objects** window, choose from the **Available objects** the estimators you want to be in the combined estimation and click the right-arrow button to move them into the **Selected objects** list. Click **OK** to return to the **New Combined Estimator** window.

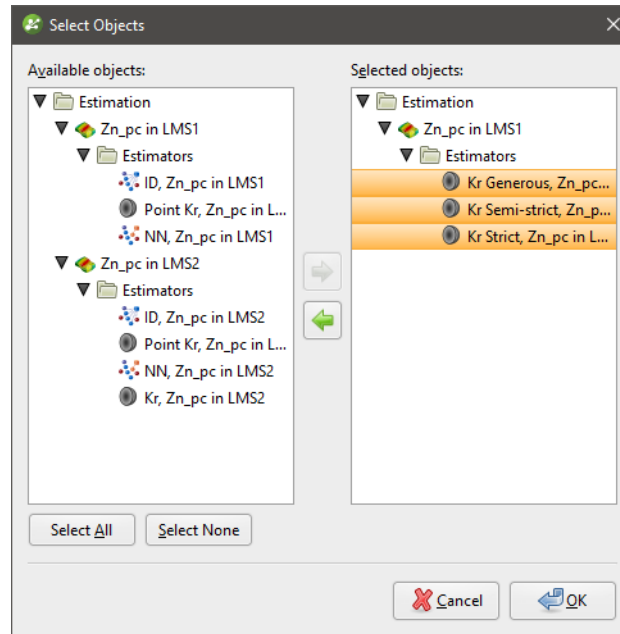

Reorder the estimators in the hierarchy by selected an estimator and clicking the **Higher** or **Lower** buttons to move it up or down the list.

Give the combined estimator a recognisable identifying label by changing the **Name**.

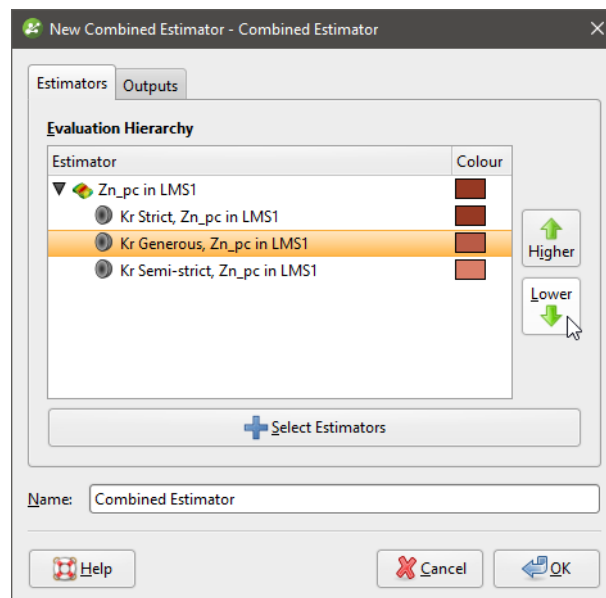

In the **Outputs** tab, select attributes you wish to be generated along with the estimate.

Value and Status will always be generated. Other attributes may be selected if all the estimators are Kriging estimators. If one or more estimators is a nearest neighbour or inverse distance estimator, many of the attributes will not be available.

Most of the attributes are identical to those described for the Kriging estimator. See [Kriging Attributes](#) for more information.

Two attributes specific to combined estimations are new category/lithology columns:

- **Dom** (domain), which domain from the domained estimations the evaluation came from.
- **Est** (estimator), which estimator was used to estimate the block.

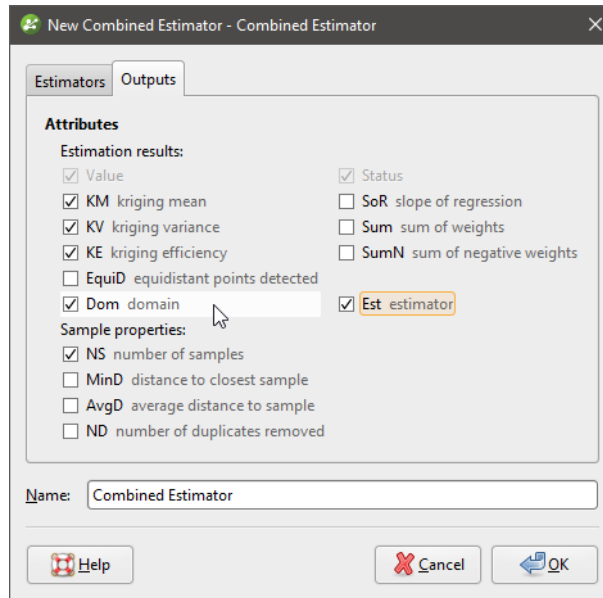

When you click **OK** a new combined estimator will appear in the **Estimation** folder. Below it will be links to the estimators that are being combined.

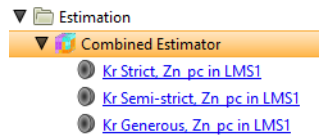

Evaluating a Combined Estimation

Combined estimations can only be evaluated on a block model. Right click a block model and select **Evaluations**, then select a combined estimation from the **Available evaluations** and add it to the **Selected evaluations** list. Click **OK**.

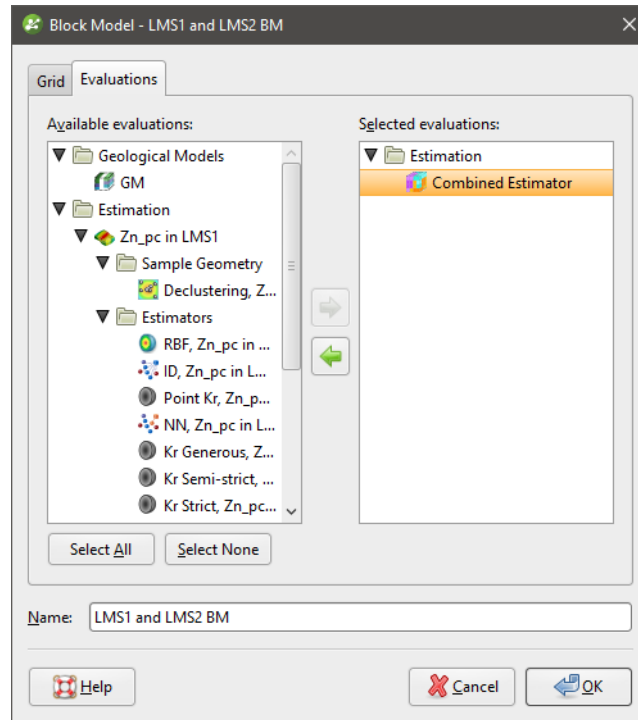

The block model with the evaluated combined estimation can be added to the scene.

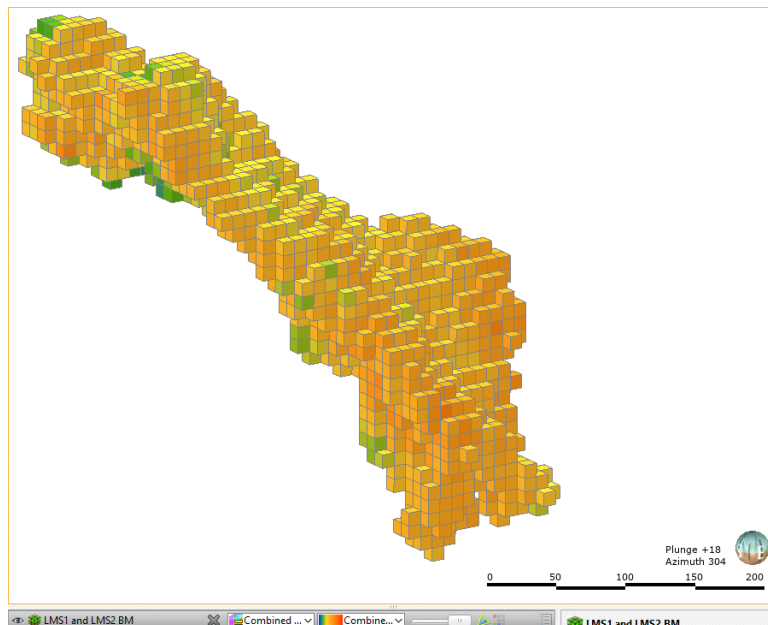

In this example, three estimators use progressively more generous search space and limits. The most strict estimator produces high confidence estimates, but over a small subset of the blocks in the block model. The block model is shown with two views; one displaying the estimate values, the other showing status, and specifically the **Normal** and **Without Grade** blocks.



A larger search space produces estimates for more blocks, but many are still **Without Grade**.

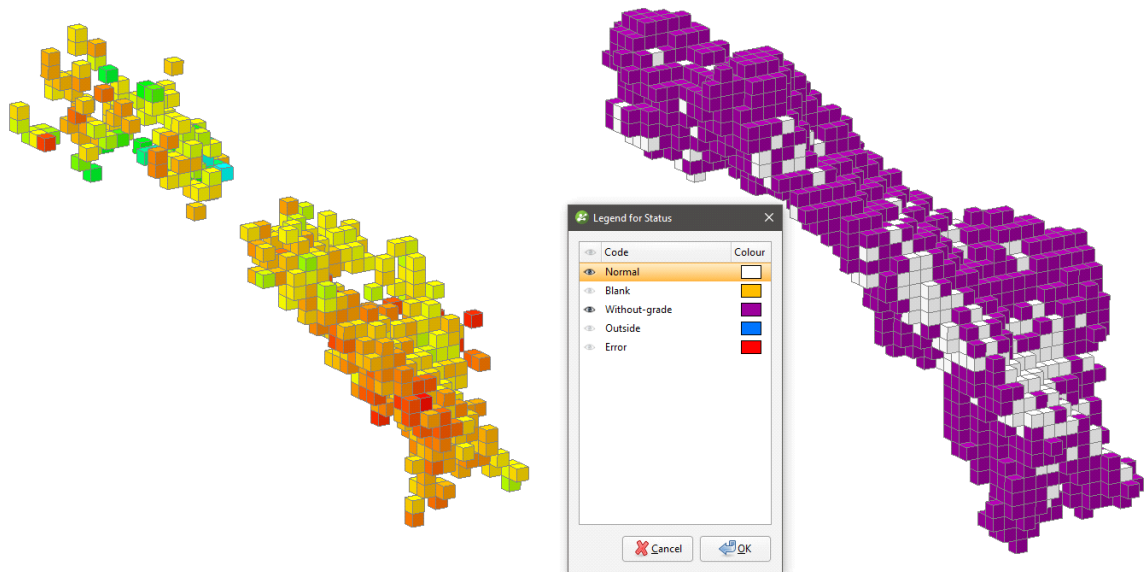

A much larger search space and reduced limits produces results for almost all the blocks in the domain.

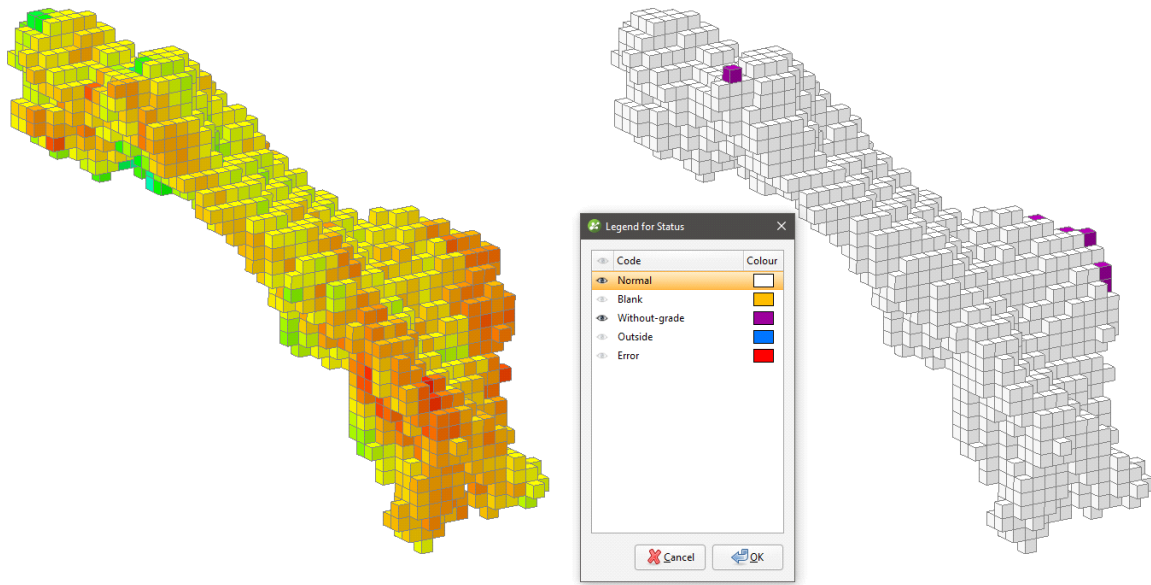

When these estimates are combined in that order, the blocks are only represented by an estimate if it has not already been given an estimate by a higher priority estimate in the hierarchy. The resulting block model evaluation may look a lot like the estimate with the most blocks, but an inspection of the evaluations of each of the blocks would reveal the subtle differences where blocks have been estimated with higher priority estimators.

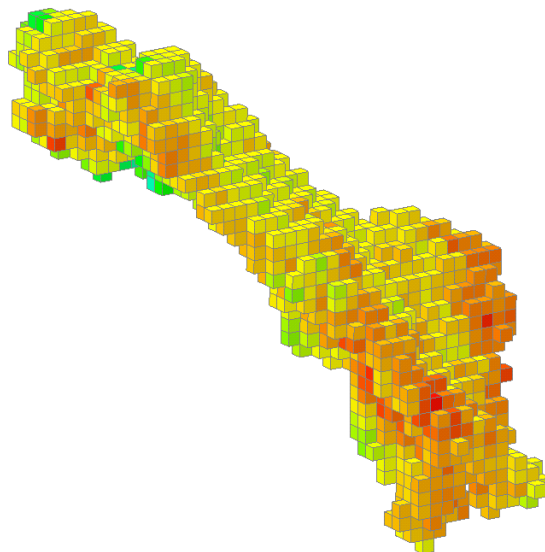

Alternatively, you may have two different, possibly overlapping domain meshes. You can evaluate each domained estimation on a block model one at a time, but not in the same scene.

Using combined estimators we can combine the estimator used for this block model:

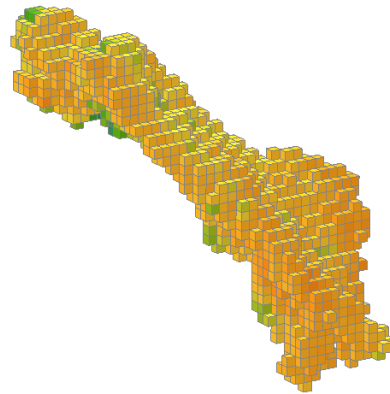

...with the estimator used for this block model.

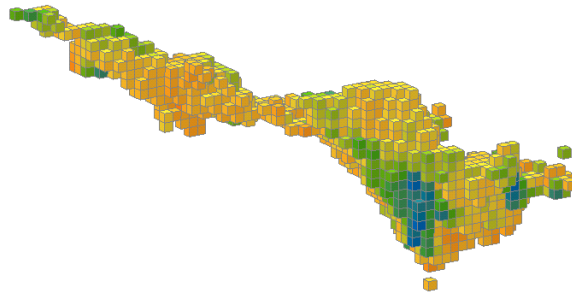

Right click the **Estimations** folder and select **New Combined Estimation**. Click the **Select Estimators** button. Add an estimator from the domained estimations for each of these separate (and possibly overlapping) domains to the **Selected objects**.

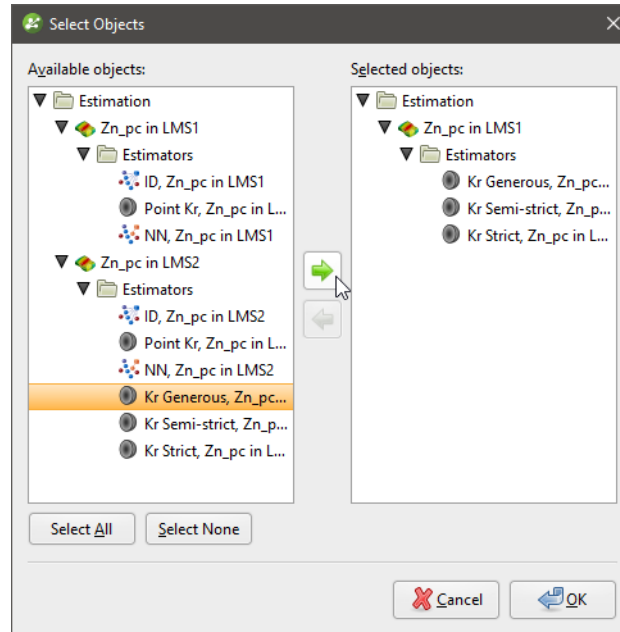

When you click **OK**, the **New Combined Estimator** window shows the selected estimators within their domained estimations.

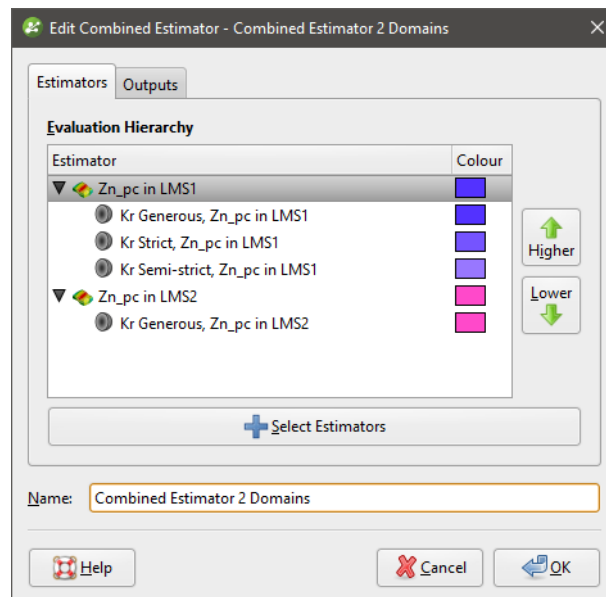

You can click the colour chip next to the domained estimation to choose an alternate base colour for the domained estimation. The colours for each of the estimators within a domained estimation are selected automatically as variations on the base colour, and cannot be customised.

When the combined estimation is evaluated onto a block model, all the estimated blocks can be displayed in the scene, combining the domains.

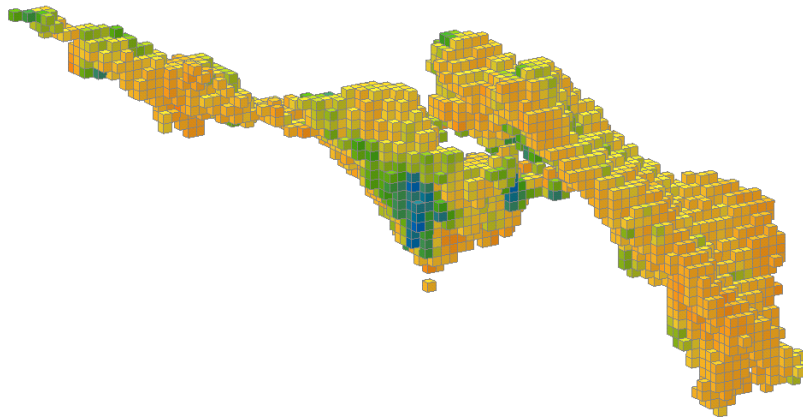

Instead of displaying the estimated values, the **Dom** (domain) attribute may be shown instead, clearly indicating which blocks in the scene are in which domain.

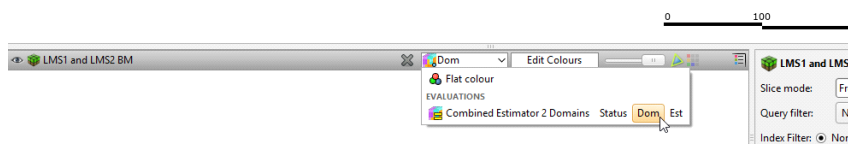
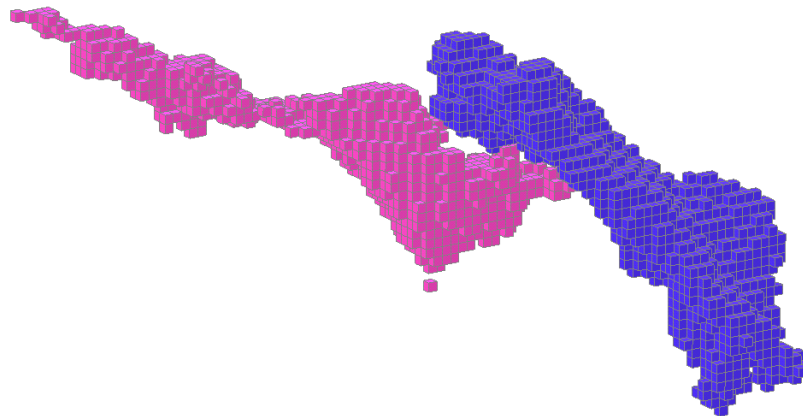

Here more estimators have been added to the combined estimator.

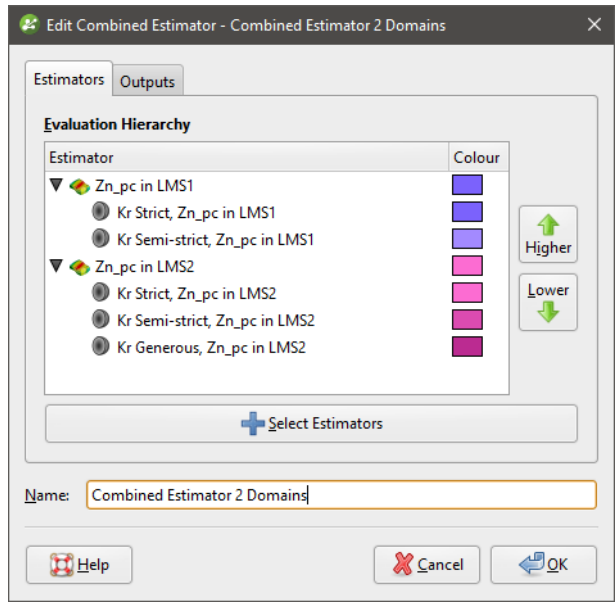

When displaying the **Est** (estimator) attributes, the colour variation from the base domain colour shows the different estimators used to evaluate the blocks.

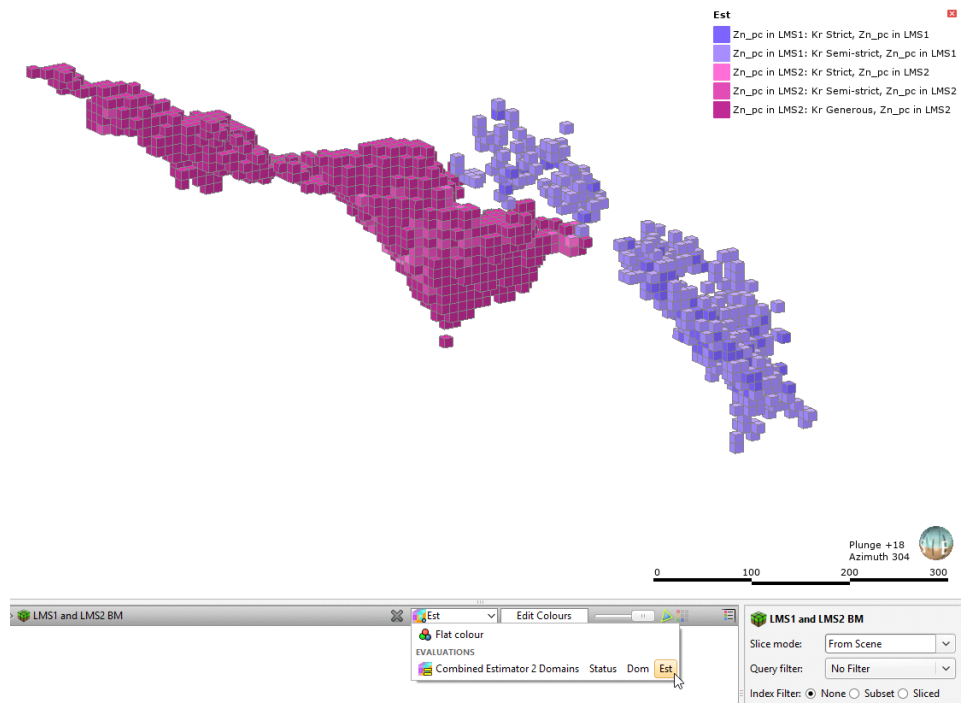

Viewing Statistics

Right click a combined estimator evaluation on a block model, and select **Statistics**. For more information on the univariate statistics displayed, see [Univariate Graphs](#).

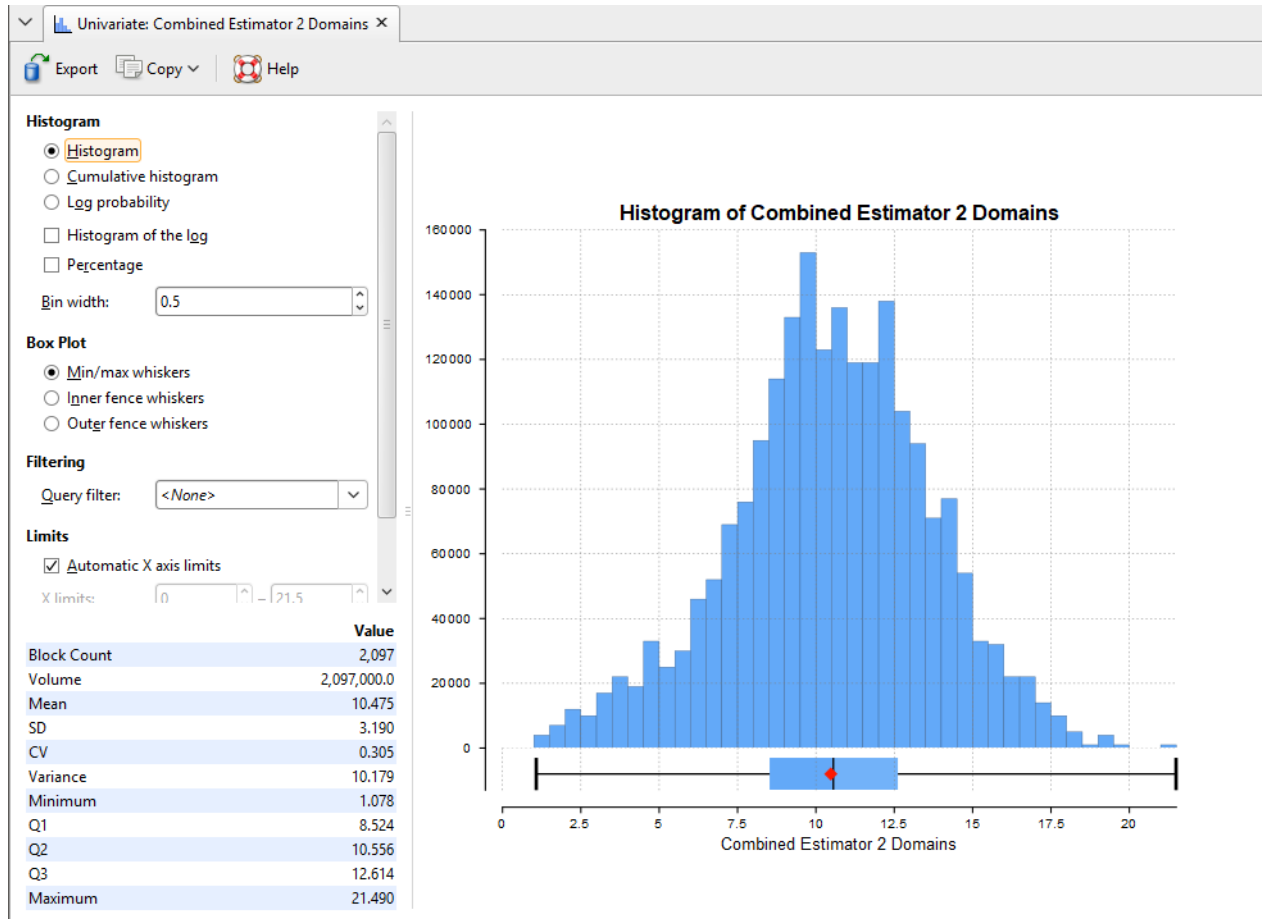

Copying a Combined Estimation

Right click a combined estimator in the **Estimation** folder and select **Copy**.

Calculations and Filters on Block Models

The features described in this topic are only available if you are licensed to use Leapfrog Edge with Leapfrog Geo.

Calculations and Filters use estimators and data to derive new values, resource classifications and more. A powerful and versatile tool, it offers a simple and intuitive editor so you do not need to be an expert programmer to make use of its pure functional language to define calculations. Even complex calculations can be developed with ease.

This topic describes how to define calculations and filters for block models. It is divided into:

- [The Calculations Window](#)
- [Creating a New Calculation or Filter](#)
- [Understanding Errors Reported in the Errors Pane](#)
- [Building Calculations and Filters](#)
- [Null Values](#)

The topic that follows, [Catalogue of Metadata, Syntax and Functions](#), details each of the items in the pinnable **Insert** list and includes intentionally trivial examples to illustrate the use of the item, along with an explanation of the effect of the expression.

A printable guide is available that contains this topic and the [Catalogue of Metadata, Syntax and Functions](#) topic. The guide is a useful reference to help you get started with the **Calculations and Filters** editor. To download this guide, click [here](#).

The Calculations Window

Once you have defined a block model (see [Block Models](#)), you can define a set of calculations and filters for it by right-clicking on the block model in the project tree and selecting **Calculations and Filters**:

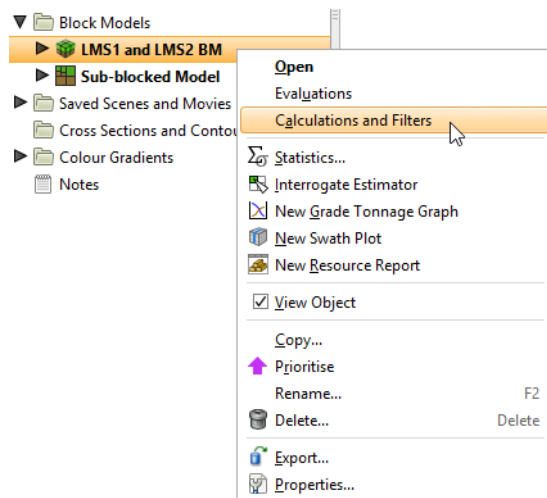

When the **Calculations** window is first opened, the **Insert** list is pinned to the right-hand side. You can untick the **Pin Window** box to get more screen space:

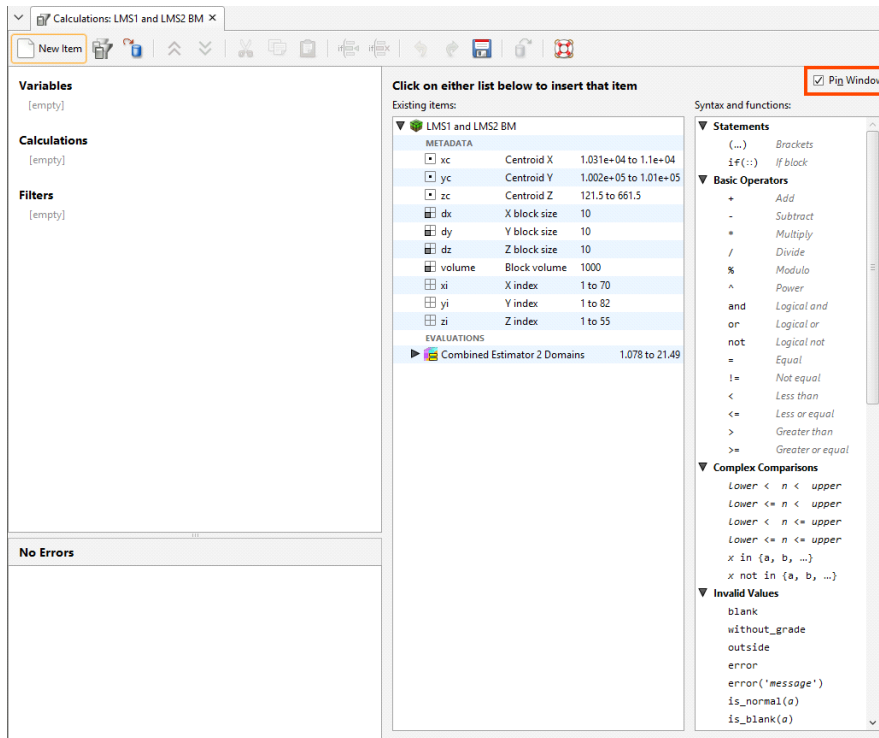

You can then select items by clicking on the **Insert** menu:

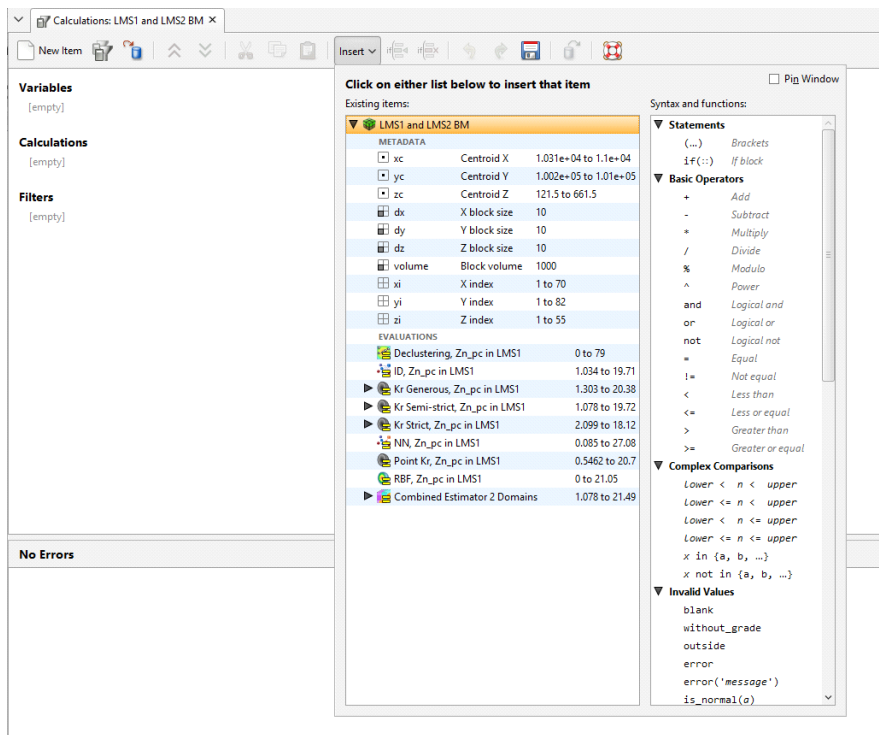

Items in this list are divided into **Existing items** and **Syntax and functions**. **Existing items** include handy metadata items you can use immediately, e.g. block size and volume measurements. It also includes evaluations that can be selected, such as estimators. **Syntax and**

functions contains mathematical operators and other calculation elements, along with special values such as 'blank' and 'outside' and pre-made functions such as unit conversions and $\log(n)$.

If the **Calculations** window is docked as a tab, you can tear the tab off to form a stand-alone window. You might do this when arranging your windows so you can see the **Calculations** window at the same time as the scene. The detached window can be docked again by dragging the tab back alongside the other tabs, as described in [Organising Your Workspace](#).

The toolbar in the **Calculations** window has three buttons that relate to copying, importing and exporting calculations and filters between block models and projects:

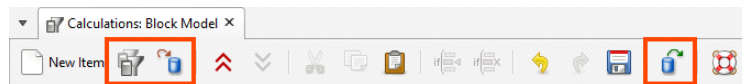

To copy calculations and filters from another block model, click the **Copy** button (📄) and select which model to copy from.

To export calculations and filters, click the **Export** button (📄). You will be prompted for a file name and location. The information is saved in *.lfcalc format, which is a binary file format. This format cannot be read or written by any other program.

To import calculations, click on the **Import** button (📄) and select a calculations file to import.

The arrow buttons (📄 and 📄) allow you to quickly expand or collapse all calculations and filters. You can also individually expand or collapse a calculation or filter by clicking on the \Rightarrow symbol next to the calculation or filter name.

Creating a New Calculation or Filter

Click the **New Item** button to add a calculation to the **Calculations** window:

The **New Item** windows gives you the choice of creating a variable, a numeric calculation, a category calculation, or a filter. Select one of these options, enter a name for the new item and click **OK**.

The item will appear in the list on the left-hand side of the **Calculations** window:

If you want to delete an item, click on it in the list, then select **Delete**:

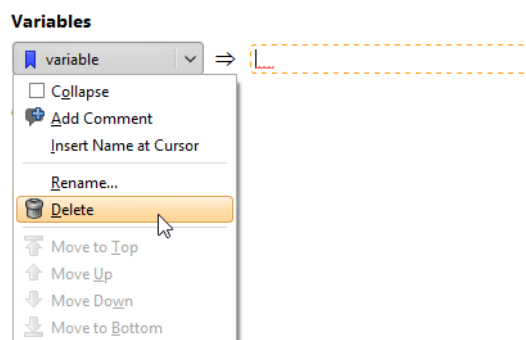

Variables

A **Variable** is an expression that is given a name to make it simple to refer to the expression in other parts of the **Calculations** window. Note that 'variable' is a homonym/homograph that in a different context has a different meaning; 'variable' is at times used to refer to a mineral such as

gold or silver. In the context of calculations and filters, the meaning is aligned with the use of the word in mathematics and scripting languages.

Using a variable in calculations can make the calculations easier to read and understand. It also makes it simple to reuse an expression multiple times in different places. Any time you find the same expression appearing in different calculations, or in different parts of a calculation, split that expression out into a variable. You can even use a variable to represent a constant value, such as a particular density measure. You can use it to hold a value you want to change as you experiment. If the value is used in multiple places in other expressions and calculations, using a variable in those places means you only need to change the value in one place instead of many.

Numeric Calculations

A **Numeric calculation** is an expression that evaluates to a number, or a number for each block evaluation used as input. A numeric calculation can be viewed in the 3D scene as a block model.

Category Calculations

A **Category calculation** is an expression that evaluates to text, usually used to label a category or classification such as a lithology or grade description. If a block evaluation is used as input, each block will be assigned a text label to categorise it according to the evaluation value. A category calculation can be viewed in the 3D scene as a block model.

Filters

A **Filter** is an expression that limits the data to specified constraints. When viewing a block model in the scene view, filters can be selected in the properties panel's **Query filter** option to constrain which blocks are displayed.

Understanding Errors Reported in the Errors Pane

Items in the **Existing items** list or in the **Syntax and functions** list can be selected and added to the **Calculations** pane. While a calculation or filter is incomplete, the **Error** pane will identify what is needed to make the calculation valid.

The errors pane will report when the syntax of an expression cannot be validly interpreted. It cannot report when the expression is not correctly structured to do what was intended.

While you are in the process of constructing an expression, errors will be reported when the incomplete expression cannot be validly interpreted:

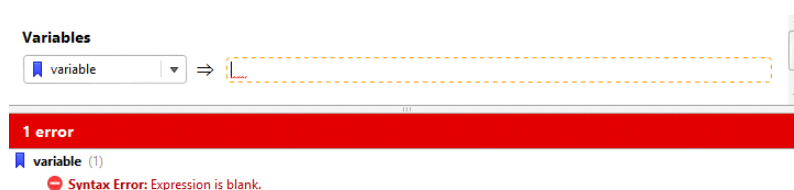

The messages provide the reason the expression is not valid or complete, but it cannot tell you how to complete or correct the equation.

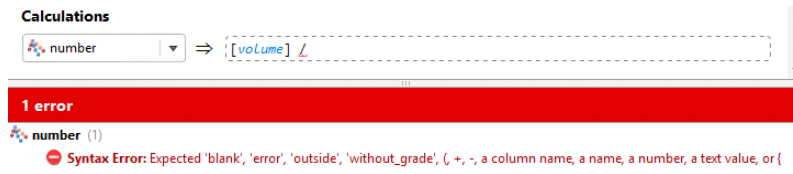

Other errors will be displayed when the type of result doesn't match the sort of calculation selected when it was created. A numeric calculation needs to produce numbers, a category calculation needs to produce text results, and filters need to produce true or false (boolean) results.

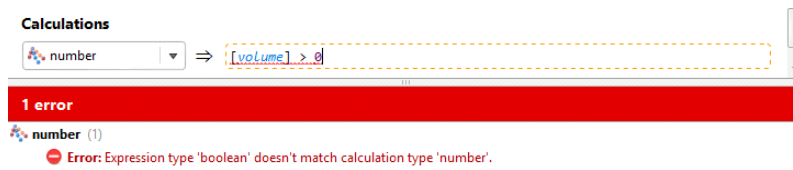

Text needs to be identified by enclosing it with quotation marks, so it is not mistaken by the calculation engine as some sort of unspecified constant.

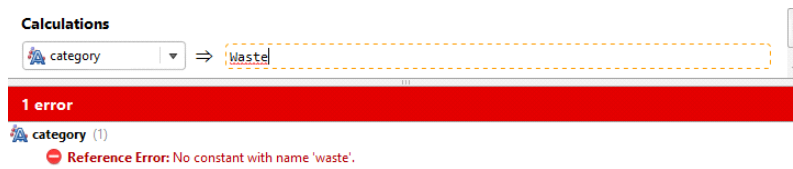

A processing error indicates a problem executing part of the calculation, for at least one of the blocks. The function may be syntactically correct, but the calculation cannot be performed for one or more blocks for some other reason. In the example below, **number** will not be able to be calculated if the Y index is ever below 3, as that will result in a divide by zero error. Because the Y index ranges from 1 upwards, this does indeed cause a processing error. Not all processing errors will be divide by zero errors. The list of problems that will be reported as processing errors includes:

- divide by zero
- log of zero or a negative number
- log base of 1
- raising a negative number to a fractional power
- sqrt of a negative number
- numeric overflow, producing a number outside the range -1e308 to 1e308
- a null value (blank, outside, without_grade) in a set
- multiple instances of the same value in a set
- referencing a column that has been deleted
- referencing a column that contains processing errors

Some processing errors will report that the problem is due to 'above errors', referring to errors higher in the errors list.

Processing errors will include a count of the number of affected blocks.

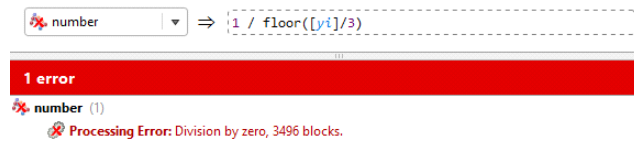

You may have more than one error shown. As a rule of thumb, address the errors at the top first, as this corrective action may address the subsequent error.

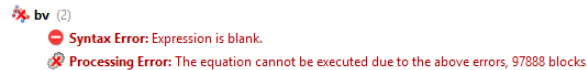

Building Calculations and Filters

Items in the **Existing items** list or in the **Syntax and functions** list can be selected and added to the **Calculations** pane. Wherever a dotted box appears in the **Calculations** pane, you can add items and operators. Select an insertion point by clicking the dotted box where the item is required. You will see that the colour of the dotted box turns from black to orange to indicate that it is the currently selected entry box. Insert an item from one of the lists by clicking on it.

Select additional operators, constants, evaluations or other items as required, or type in values:

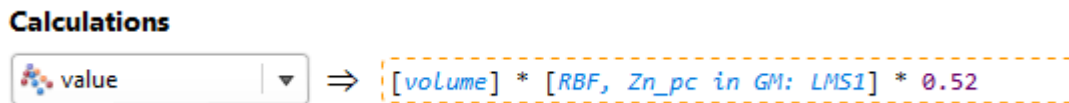

Some items you insert include placeholders that need to be replaced. For example, here, a value needs to be entered at the cursor position and the terms 'lower' and 'upper' need to be replaced with other items:

The if (::) conditional statement can have additional rows added to it. Insert the cursor where you want to insert a row and then click the **Add Row** button (⊕) and a row will be added above the selected line:

You can hold the Shift key to add the row below the cursor. To delete the selected row, click the **Delete Row** button (⊖).

A calculation or filter can be renamed after it has been created. Click on its name and select **Rename** from the menu that appears:

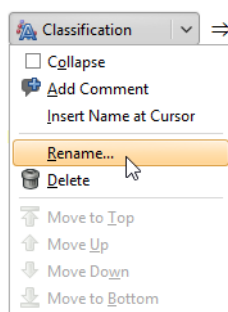

Examples of Variables

Variables can produce numeric, boolean, or text results. You may create a variable because using a variable in other expressions can make them easier to read and understand, or it can let you change a value in just one place, even though it is used in many expressions.

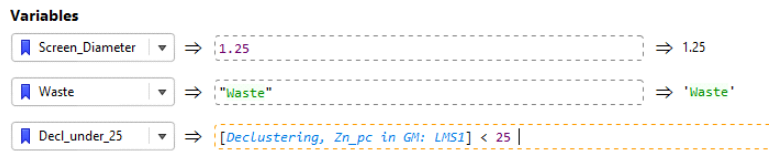

While producing results similar to numeric calculations, category calculations or filters, variables cannot be viewed on the block model in the 3D scene.

Example of a Numeric Calculation

Numeric calculations must produce numeric results, or an error will be reported.

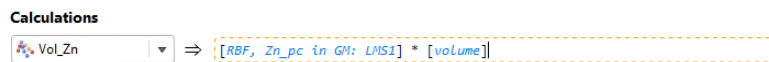

The results of the numeric calculation for the block model can be viewed in the 3D scene by right-clicking on the numeric calculation entry in the project tree and selecting **View Object**.

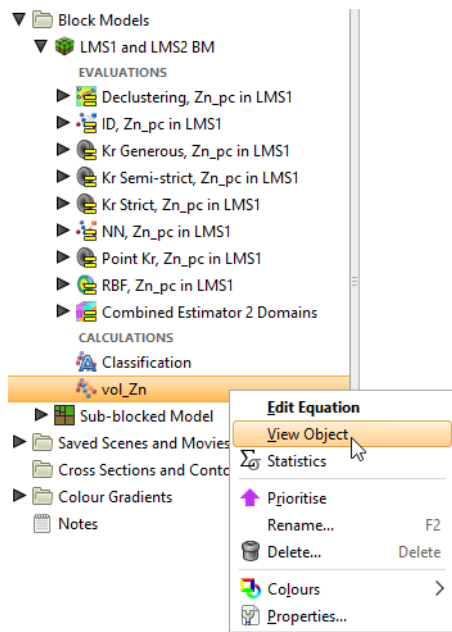

Example of a Filter

In this example, one of the selectors from the **Complex Comparisons** options has chosen from the insert list. The value that will be tested is to be added at the insertion point between the comparators, and the placeholder words 'lower' and 'upper' need to be replaced with constants.



Here the RBF estimator has been specified as the value that will be tested, and lower and upper limits for the processable ore have been specified.



When you select **View Object** for the filter in the project tree, the block model will be displayed with the **Query filter** set to the selected filter in the shape properties panel.

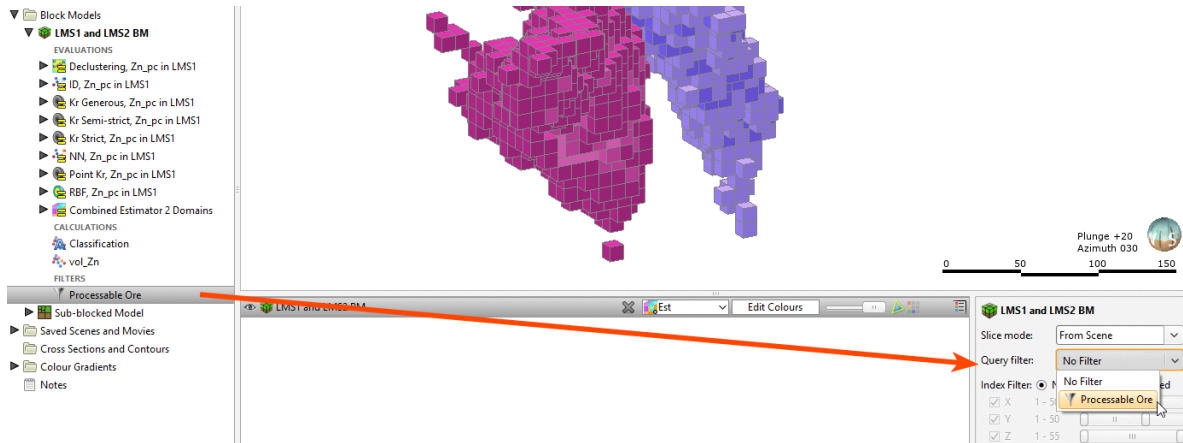

Example of a Category Calculation

This example use a category calculation to classify ore into one of several categories using the if (::) conditional statement.

The if (::) conditional statement contains two lines by default. Note the guiding cues within the dotted entry boxes. The first line describes the test to be performed that, if it evaluates as true, will produce a specified result. The 'otherwise' condition on the second line captures all the tested conditions that did not evaluate as true in the test on the first line, and these all produce an alternate result:



In this case, all the values outside of the range of the filter we have created are to be considered waste. We add the filter as the 'test' condition, and specify the label 'Ore' as the first result, and use the label 'Waste' in the bottom line for the 'otherwise' condition. So the labels are not mistaken by the calculation engine as some sort of unspecified constant, make sure labels are identified using quotation marks:

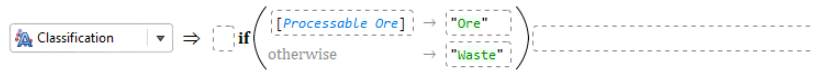

To extend this trivial example to make it more practical, we can nest if(::<) conditional statements. Replace the 'Ore' label with a new if(::<) item:

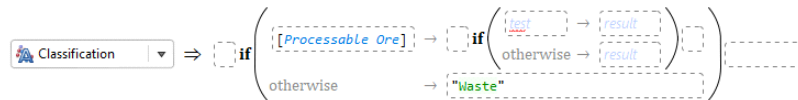

Now if values pass the filter in the first test, they then get to be sorted using the second if(::<) block. This time we will test a declustering object from the sample geometry. If the Declustering value is more than 65, we will classify this as 'Measured':

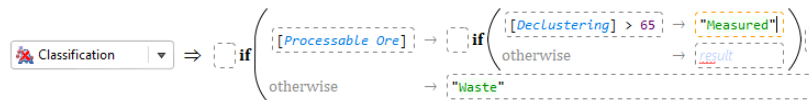

Shift-click the **Add Row** button (📄), and a new conditional row is added below the current one, where we can specify that a Declustering value greater than 36 will be classified as 'Indicated'. Only values between 65 and 36 will be classified as 'Indicated' as the first line will have already classified all the values over 65 as 'Measured'. This leaves the 'otherwise' row in the nested if(::<) block to catch data density values below 36, which are labelled 'Inferred':

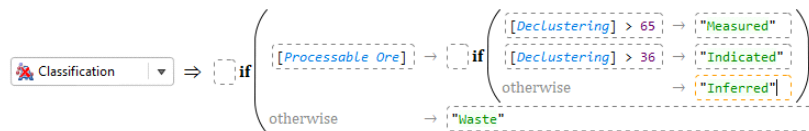

The new Classification calculation we have added under the block model can be added to the scene view.

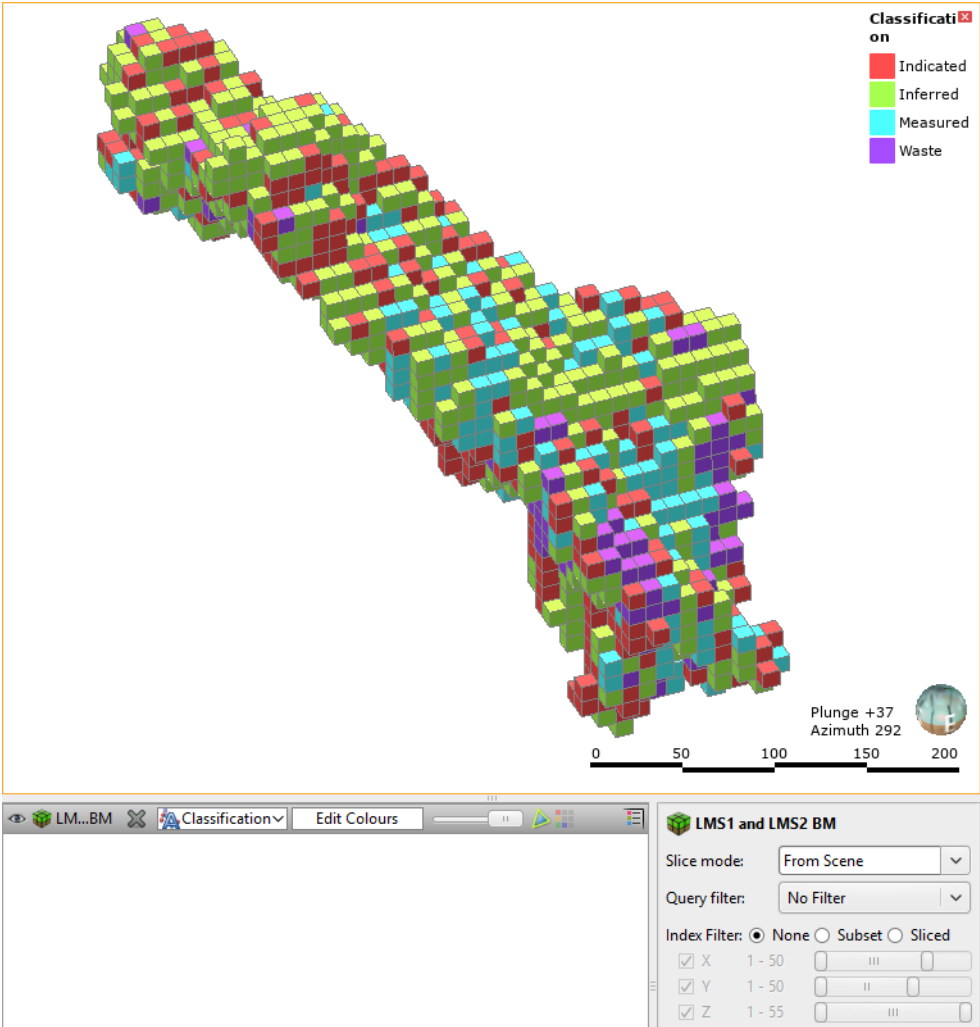

Null Values

Leapfrog Geo can differentiate between different types of invalid or null values, which are shown in the **Calculations** window:

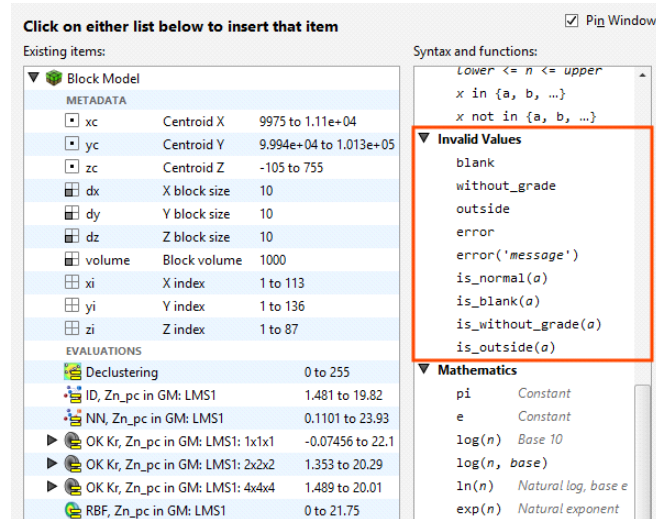

You can see how many blocks of each normal or invalid status occur in an evaluation by right-clicking on the evaluation in the project tree and selecting **Properties**:

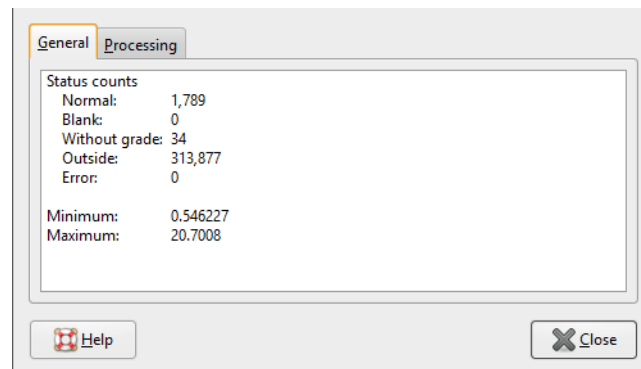

When a block model is displayed in the scene, you can choose between displaying evaluation values or the block status. Highlighted below is a Kriging evaluation, shown displayed on the block model. Next to the Kriging evaluation in the dropdown list is a **Status** option:

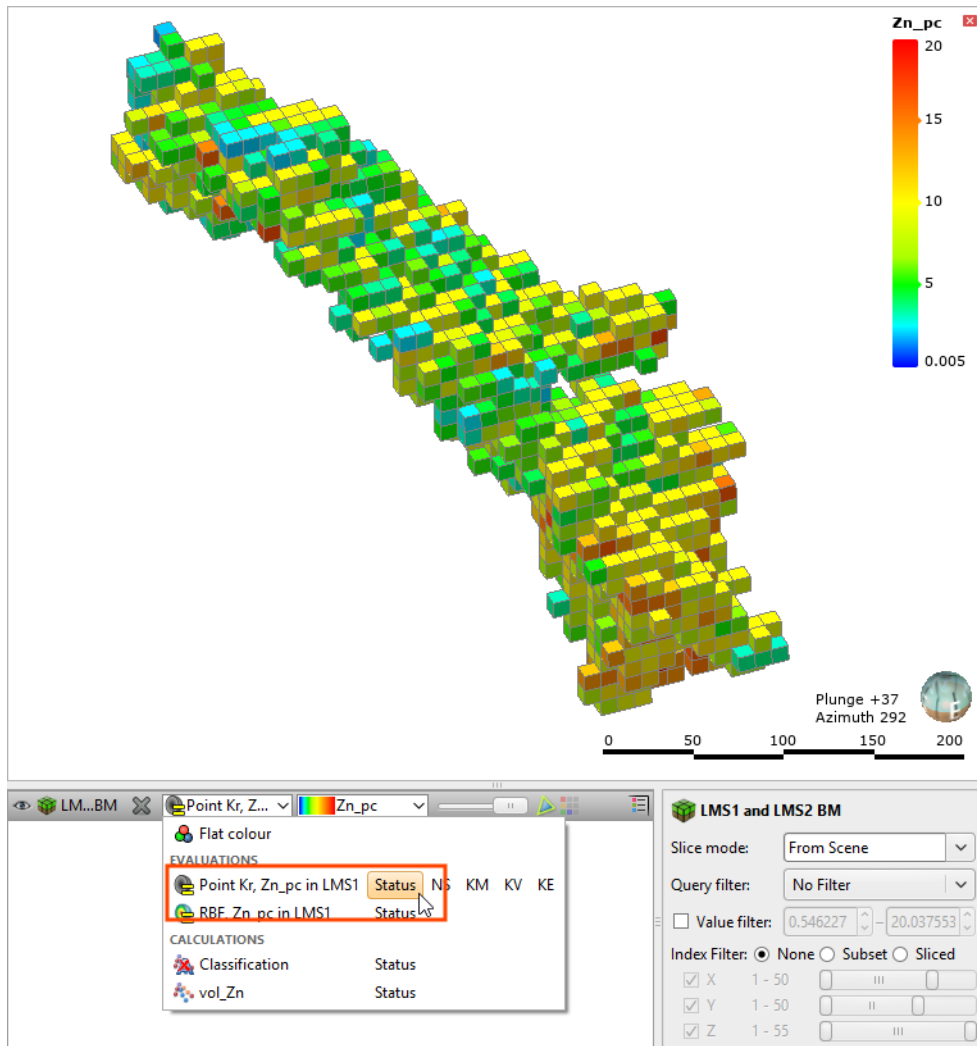

When the status option is selected, the model is displayed by block status. Click **Edit Colours** to change what status values are displayed.

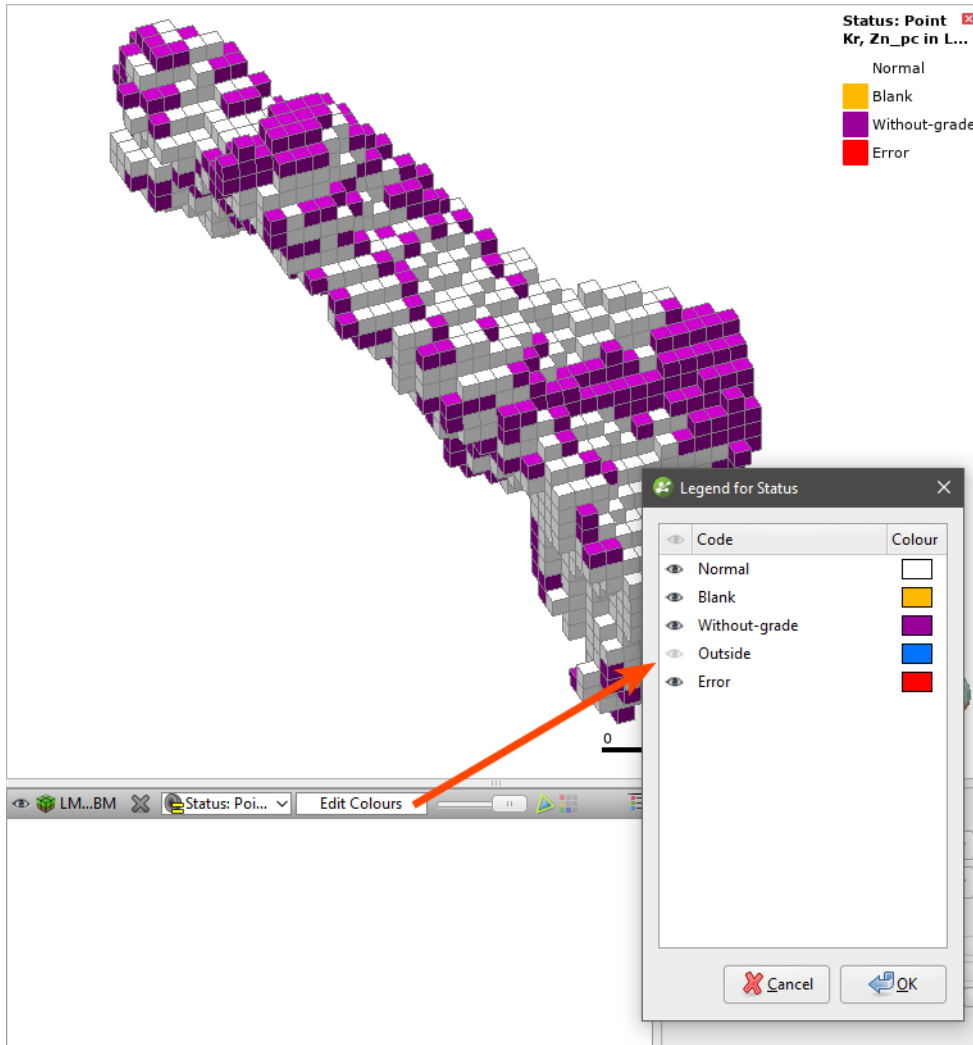

With block model statistics, you can view statistics for all evaluations and calculations made on a block model or sub-blocked model. Statistics can be broken down into categories and organised by numeric evaluations and calculations. See [Viewing Block Model Statistics](#) in the [Block Models](#) topic for more information.

Catalogue of Metadata, Syntax and Functions

The features described in this topic are only available if you are licensed to use Leapfrog Edge with Leapfrog Geo.

This catalogue details each of the items in the pinnable **Insert** list. Each item includes an intentionally trivial example to illustrate the use of the item, along with an explanation of the effect of the expression.

Existing Items

This section covers the items listed in the left-hand side of the pinnable **Insert** list:

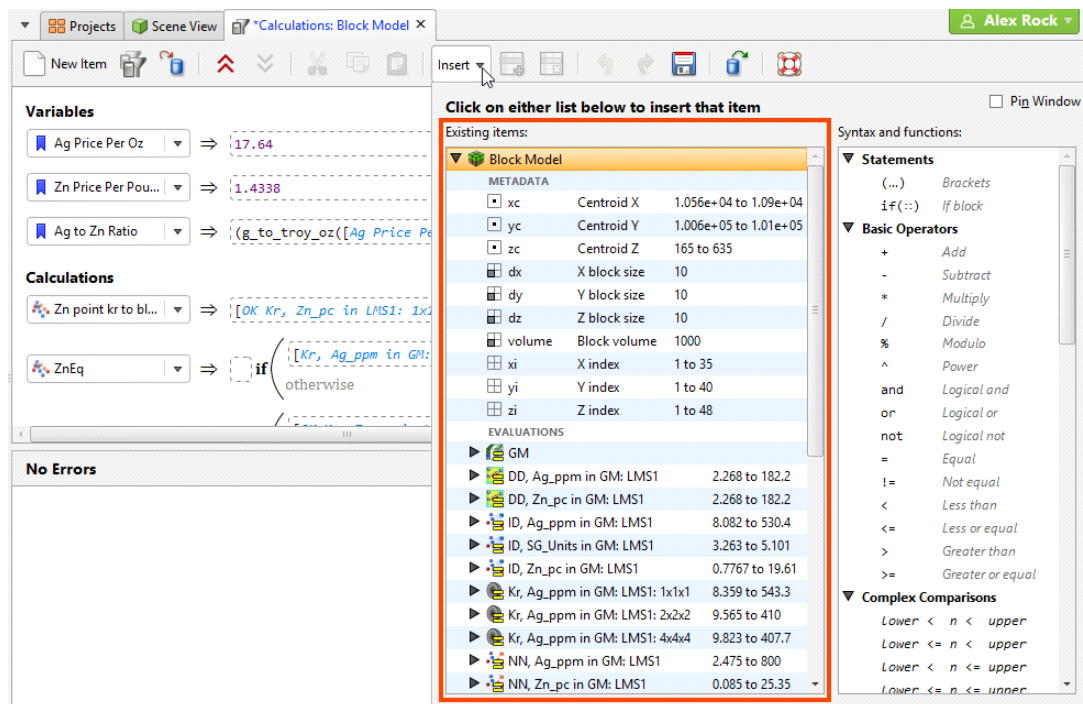

To pin these lists to the **Calculations** tab, enable the **Pin Window** option:

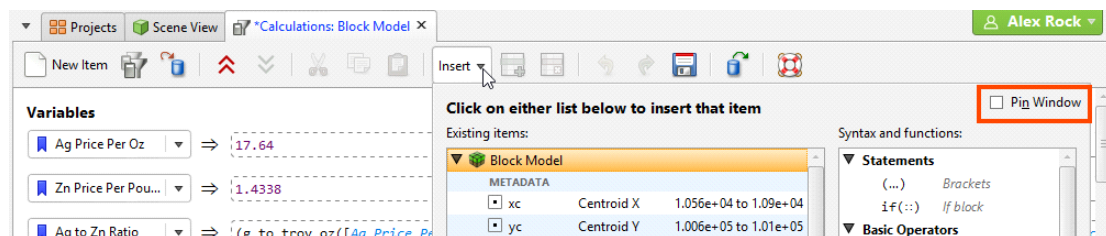

Metadata

xc, yc and zc

These three metadata items are the variables for locating the centroid of the block, in X, Y and Z coordinates. Select an item to add it to the expression at the insertion point. Note that whenever one of these metadata items is added to an expression, it is wrapped in square brackets.

Example

$$\text{top} \Rightarrow [zc] + ([dz] / 2)$$

Explanation

The numeric calculation top will be assigned the value of the location of [zc] the altitude of the block centroid from the zero reference, plus half the height of the block.

dx, dy and dz

These three metadata items are the variables for the block dimensions in X, Y and Z coordinates. Select an item to add it to the expression at the insertion point. Note that whenever one of these metadata items is added to an expression, it is wrapped in square brackets.

Example

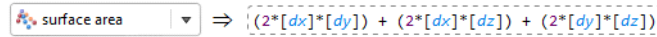

Explanation

The numeric calculation surface area will be calculated by figuring the area of each face of the block by multiplying the X and Y dimensions, X and Z dimensions and Y and Z dimensions and adding them together.

volume

This metadata item provides the volume for each block. Note that when this metadata item is added to an expression, it is wrapped in square brackets.

Example

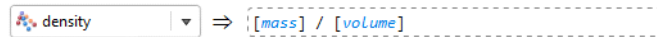

Explanation

The numeric calculation density will be assigned the value of the variable [mass] divided by the metadata item [volume].

xi, yi and zi

These three metadata items are the variables for locating the block by X, Y and Z index. Select an item to add it to the expression at the insertion point. Note that whenever one of these metadata items is added to an expression, it is wrapped in square brackets.

Example

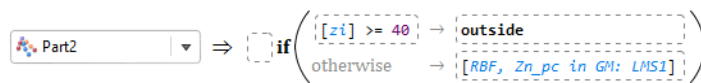

Explanation

The numeric calculation Part2 will be assigned the value of the RBF estimation, unless [zi] the Z index of the block is greater than or equal to 40, in which case the block status will be set to the invalid value outside.

Evaluations

Each of these items are automatically added to the list whenever an evaluation is added to the block model. When added to an expression, the item represents a placeholder in the calculation for a block value, as the expression is evaluated for each of the blocks in turn.

Note you can expand each evaluation in the list to see the attributes for the estimation evaluation that may also be selected instead of or in addition to the estimated value.

Example

strange ⇒ $[OK\ Kr, Zn_pc\ in\ LMS1: 2x2x2] * [DD, Ag_ppm\ in\ GM: LMS1: AvgD]$

Explanation

The numeric calculation strange is defined by [OK Kr, Zn_pc in LMS1: 2x2x2] the product of the Kriging estimate and [DD, Ag_ppm in GM: LMS1: AvgD] the average distance to sample attribute for the Data Density estimator. Each block in the block model will have its own values for the Kriging estimate and the Data Density AvgD attribute, and this calculation uses those values to create a new value named strange for each block, using the formula above.

Variables, Calculations and Filters

Each time you create a new variable, numeric calculation, category calculation, or filter in **Calculations**, it will also be added to the **Existing items** list. You can select them from this list and they will be inserted into your new expression at the insertion point. Note that whenever one of these named items is added to an expression, it is wrapped in square brackets.

VARIABLES	
Ag Price Per Oz	
Zn Price Per Pound	
CALCULATIONS	
high	1.711 to 25.35
low	0 to 18.72
jumble	
FILTERS	
high ge Ag \$/oz	
low le Zn \$/lb	

Example

Variables

- Ag Price Per Oz ⇒ 17.64
- Zn Price Per Pound ⇒ 1.4338

Calculations

- high ⇒ $\max([NN, Zn_pc\ in\ GM: LMS1], [OK\ Kr, Zn_pc\ in\ LMS1: 2x2x2], [RBF, Zn_pc\ in\ GM: LMS1])$
- low ⇒ $\min([NN, Zn_pc\ in\ GM: LMS1], [OK\ Kr, Zn_pc\ in\ LMS1: 2x2x2], [RBF, Zn_pc\ in\ GM: LMS1])$
- jumble ⇒ $if([high\ ge\ Ag\ \$/oz] \rightarrow "red", [Low\ le\ Zn\ \$/lb] \rightarrow "blue", otherwise \rightarrow "green")$

Filters

- high ge Ag \$/oz ⇒ $[high] \geq [Ag\ Price\ Per\ Oz]$
- low le Zn \$/lb ⇒ $[low] \leq [Zn\ Price\ Per\ Pound]$

Explanation

This example is only attempting to illustrate how variables, calculations and filters that have already been defined can be referenced by name in new calculations; there is nothing useful about the calculation jumble.

It is good practice to break your calculations down into parts, giving each part a relevant and readily identifiable, unambiguous and easily understood name. This will make your calculations

more readable and clear. Using **Variables** to define a constant with a name makes it easy to understand the utility of that particular constant when you use it in a calculation. You may also be able to re-use certain parts such as filters or constant variables, so you do not need to define the same thing repeatedly. As a counterpoint, compare the following calculation that does the same jumble calculation above, but it is more difficult to interpret because everything is thrown in together:

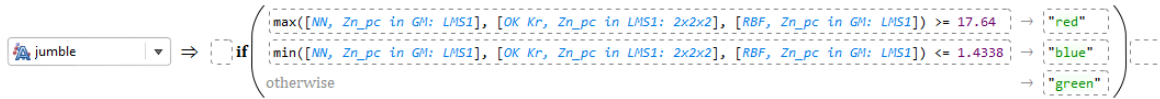

Be careful not to inadvertently name something incorrectly, such as naming a volume as "area", as this could give rise to difficult-to-locate errors in your calculation.

Syntax and Functions

This section covers the items listed in the right-hand side of the pinnable **Insert** list.

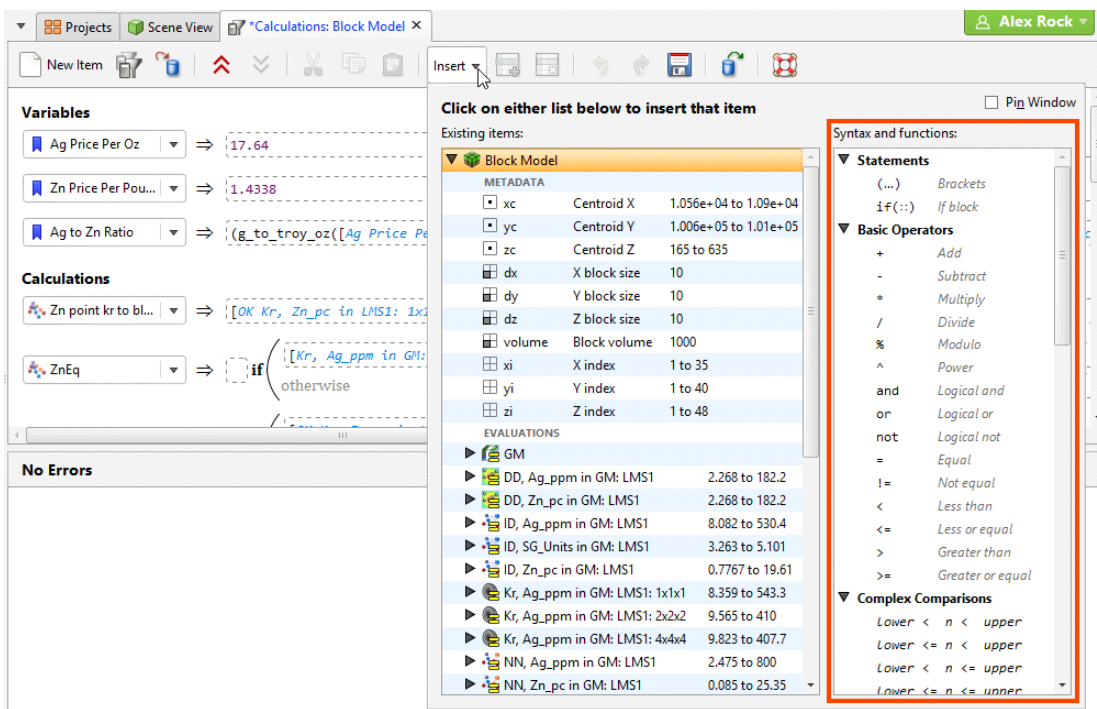

To pin these lists to the **Calculations** tab, enable the **Pin Window** option:

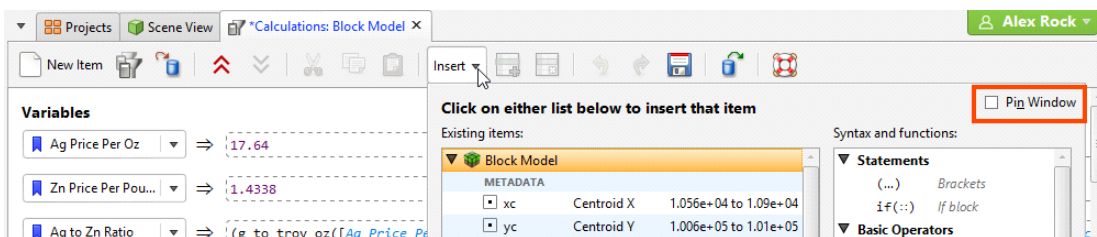

Statements

(...) Brackets

Brackets are used to enclose an expression so the operations on the values within the brackets take precedence over operations outside the brackets.

Example

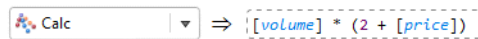

Explanation

2 + [price] will be calculated prior to [volume] * the result of the expression in the brackets.

if(::<) If block

The **If block** is used for conditional logic. This allows multiple pathways to results depending on selected conditions, or categorisation based on values.

An **If block** will be evaluated by each test → result, row by row, separately and in order downwards by row. Each test has an output that can be 'true', 'false', or an invalid value 'error', 'blank', 'without_grade' or 'outside'. The result output is produced by the execution of the result expression. The **If block** output follows these rules:

- If a test output is 'error', the **If block** output is 'error' and no further processing of subsequent rows is done.
- If a test output is 'false', the result expression is not executed, and the next row is considered.
- If a test is 'true', the result expression is executed and the result output is used for the **If block** output and no further processing of subsequent rows is done.
- If all the tests are 'false', the 'otherwise' result expression is executed and its output is used.
- If a test output is an invalid value (without_grade, blank, outside) the result expression is not executed and the test output's invalid value is remembered. The subsequent rows are then run.
- If a subsequent test output is 'true' after an earlier one produced an invalid value, the previous test output is discarded and the new row's result expression output is used as the output for the **If block**.
- If all test outputs are invalid status values, the highest priority status of all the remembered invalid statuses is used as the output result. The priority of non-error invalid status values is: outside > without_grade > blank.

Additionally, it is possible to choose to produce invalid values as the output of result expressions.

Example



Explanation

[OK Kr, Zn_pc in LMS1: 2x2x2] is the automatically generated variable name for the block estimate from a Kriging estimate of Zn_pc (Zinc, percentage) values in a LMS1 domain with 2x2x2 discretisation. As the **if(::<) If block** calculation is run for each of the blocks in the model, the estimate for that block replaces this variable name in the expression. If the value is greater than the value of the constant pi, the result will be the text string 'Blue'. Otherwise, if the value is less than or equal to pi, the result will be the string 'Red'.

Additional rows may be added. Each row follows on from the left-over results of the line before, simplifying the logical expression that may be used.

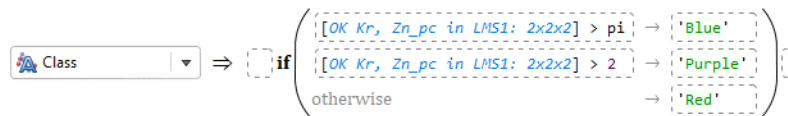

Explanation

Note the addition of the line [OK Kr, Zn_pc in LMS1: 2x2x2] > 2 → 'Purple'. This line can be interpreted to mean: if the value estimated for the block is less than or equal to pi, but greater than 2, the result shall be 'Purple'. The part about it being less than or equal to pi is implied because the line follows the previous line [OK Kr, Zn_pc in LMS1: 2x2x2] > pi → 'Blue'.

Note that expression elements before and after the if expression can be entered. This allows the **if(::<) If block** to form part of a more complex or extensive expression.

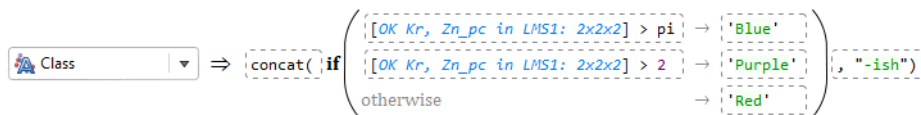

Explanation

The earlier conditional classification has now been embedded within a concatenation function, forming the first part of a two-part string concatenation. The concatenation function is adding the text string "-ish" to whatever is produced by the **if(::<) If block**. Thus, if the value of the block being evaluated is 1.2, the result of the Class categorisation calculation will be 'Red-ish'.

Basic Operators

+ Add

An arithmetic addition operation.

Example

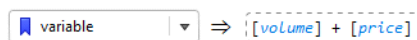

Explanation

variable is assigned the value of [volume] plus [price].

- Subtract

An arithmetic subtraction operation.

Example

⇒ `[volume] - [price]`

Explanation

variable is assigned the value of [volume] minus [price].

* Multiply

An arithmetic multiplication operation.

Example

⇒ `[dx] * [dy] * [dz]`

Explanation

block_vol is assigned the value of [dx] times [dy] times [dz]. Note: you do not need to calculate the block volume like this, as the volume metadata item already exists under **Existing items**.

/ Divide

An arithmetic division operation.

Example

⇒ `[volume] / [price]`

Explanation

variable is assigned the value of [volume] divided by [price].

% Modulo

An arithmetic modulo operation. This is an integer division operation that returns the remainder instead of the integer quotient.

Example

⇒ `[volume] % [price]`

Explanation

variable is assigned the value of [volume] modulo [price], or in other words, [volume] is divided by [price] to produce an integer quotient, the number of times [price] goes into [volume], and the remainder, which is the number returned by this modulo function.

^ Power

A mathematical exponentiation operation where a base is raised to the power of the exponent.

Example

⇒ `pi * [radius]^2` ⇒ 3.141592653589...

Explanation

variable is assigned the value of $\pi * [\text{radius}]^2$ (because ^2 is interpreted as 'exponent 2' or 'squared'). Because [radius] happened to be defined as equalling 1, the result of $\pi * 1^2$ equals π , as can be seen from the result at the end of the expression ⇒ 3.141592653589...

and Logical and

A logical and operation.

Example

⇒ `{([RBF, Zn_pc in GM: LMS1] > e) and ([DD, Zn_pc in GM: LMS1] < 100)}`

Explanation

filter will be true if the RBF estimate for the block is greater than e AND the data density function is less than 100, but it will be false otherwise.

or Logical or

A logical or operation.

Example

⇒ `{([RBF, Zn_pc in GM: LMS1] > e) or ([DD, Zn_pc in GM: LMS1] < 100)}`

Explanation

filter will be true if the RBF estimate for the block is greater than e OR the data density function is less than 100, but it will be false otherwise.

not Logical not

A logical not operation.

Example

⇒ `{not is_normal([RBF, Zn_pc in GM: LMS1])}`

Explanation

filter will be true if the result of the function `is_normal` using the block RBF estimate value as input returns false; filter will be false if the result of the `is_normal` function returns true. The logical operator `not` inverts the logical expression that follows the operator.

= Equal

A logical equality operator.

Example

⇒ `{[RBF, Zn_pc in GM: LMS1] = 0}`

Explanation

filter will be true when the value of the RBF estimate for the block is equal to 0, and will be false for all other values.

!= Not equal

A logical not-equal operator.

Example

⇒ `[RBF, Zn_pc in GM: LMS1] != 0`

Explanation

filter will be true when the value of the RBF estimate for the block is not equal to 0, and will be false when it does equal 0.

< Less than

A logical less-than operator.

Example

⇒ `[NW, Zn_pc in GM: LMS1] < e`

Explanation

filter will be true when the value from the Nearest Neighbour estimate for the block is less than e, and false otherwise.

< Less or equal

A logical less-than-or-equals operator.

Example

⇒ `[NW, Zn_pc in GM: LMS1] <= e`

Explanation

filter will be true when the value from the Nearest Neighbour estimate for the block is less than or equal to e, and false otherwise.

< Greater than

A logical greater-than operator.

Example

⇒ `[NW, Zn_pc in GM: LMS1] > e`

Explanation

filter will be true when the value from the Nearest Neighbour estimate for the block is greater than e, and false otherwise.

< Greater or equal

A logical greater-than-or-equals operator.

Example

⇒ `[NW, Zn_pc in GM: LMS1] >= e`

Explanation

filter will be true when the value from the Nearest Neighbour estimate for the block is greater or equal to e, and false otherwise.

Complex Comparisons

Lower < n < upper

A pair of comparisons, with a logical result to indicate if the tested value n is between the lower value provided and the upper value provided.

Example

⇒ `20 < [Kr, Ag_ppm in GM: LMS1: 2x2x2] < 100`

Explanation

filter will be true when the Kriging estimation for the block is between the values of 20 and 100 (but not equalling 20 or 100); it will be false otherwise.

Lower <= n < upper

A pair of comparisons, with a logical result to indicate if the tested value n is between the lower value provided and the upper value provided, or equal to the lower value.

Example

⇒ `20 <= [Kr, Ag_ppm in GM: LMS1: 2x2x2] < 100`

Explanation

filter will be true when the Kriging estimation for the block is equal to 20 or between the values of 20 and 100 (but not equalling 100); it will be false otherwise.

Lower < n <= upper

A pair of comparisons, with a logical result to indicate if the tested value n is between the lower value provided and the upper value provided, or equal to the upper value.

Example

⇒ `20 < [Kr, Ag_ppm in GM: LMS1: 2x2x2] <= 100`

Explanation

filter will be true when the Kriging estimation for the block is between the values of 20 and 100 or equal to 100 (but not equal to 20); it will be false otherwise.

Lower <= n <= upper

A pair of comparisons, with a logical result to indicate if the tested value n is between (or equal to either) the lower value provided and the upper value provided.

Example

⇒ `20 <= [Kr, Ag_ppm in GM: LMS1: 2x2x2] <= 100`

Explanation

filter will be true when the Kriging estimation for the block is greater than or equal to 20 and less than or equal to 100; it will be false otherwise.

x in {a,b,...}

A logical inclusion expression. This will return true if x matches any element of the set of listed items.

Example

```
filter ⇒ [colour] in {'red','orange','yellow','green','blue','violet'}
```

Explanation

If [colour] is one of the items in the list within the curly brackets, filter will be true. If [colour] is anything else, filter will be false.

x not in {a,b,...}

A logical exclusion expression. This will return true if x fails to match any element of the set of listed items.

Example

```
filter ⇒ [colour] not in {'red','orange','yellow','green','blue','violet'}
```

Explanation

If [colour] is not one of the items in the list within the curly brackets, filter will be true. If [colour] matches any item in the list, filter will be false.

Invalid Values

Invalid values are different types of results for “numeric” categorisation calculations that need special non-numeric results for certain category results. These have special meanings of their own without having to resort to interpreting negative numbers and zero as having special meaning.

blank means having no value, the value in the imported file is blank or has non-numeric data

without_grade is often used to mean the estimator cannot produce a value

outside is used to indicate the block is outside the boundary of the domain

error generates an error, and provides an ‘error’ status value for the affected block

error('message') is similar to error but includes a custom message.

Multiple case example

```
number ⇒ if (
  [Simple Kr, Zn_pc in LMS1: 2x2x2] > 5 → [Simple Kr, Zn_pc in LMS1: 2x2x2]
  [Simple Kr, Zn_pc in LMS1: 2x2x2] > 0 → without_grade
  [Simple Kr, Zn_pc in LMS1: 2x2x2] = 0 → blank
  [Simple Kr, Zn_pc in LMS1: 2x2x2] < 0 → outside
  otherwise → error("impossible value")
)
```

Explanation

if the Kriging estimate is greater than 5, the result will be the Kriging estimate. If the Kriging estimate is between 0 and 5, the block will be marked as having a without_grade result and status. If the Kriging estimate is exactly 0, the block will have a result and status of blank. If the Kriging estimate is negative, the block will have a result and status of outside. This should cover all the valid cases for the Kriging estimate value, but the if(:) If block requires an otherwise clause. In this case, the result of the otherwise will be to produce an error result and status with the message "impossible value".

is_normal(a)

A function that tests a to see if it is a normal value or an invalid value. If a is normal, it returns true. If a is invalid, it returns false.

Example

⇒ `is_normal([Kr, Ag_ppm in GM: LMS1: 2x2x2])`

Explanation

If [Kr, Ag_ppm in GM: LMS1: 2x2x2] produces a normal value for a block, filter will be true for that block. If it produces an invalid value, filter will be false.

is_blank(a)

A function that tests a to see if it is a blank invalid value. If a is blank, it returns true. If a is normal or another invalid value, it returns false.

Example

⇒ `is_blank([Kr, Ag_ppm in GM: LMS1: 2x2x2])`

Explanation

If [Kr, Ag_ppm in GM: LMS1: 2x2x2] produces a blank status for a block, filter will be true for that block. If it produces any other invalid value or a normal value, filter will be false.

is_without_grade(a)

A function that tests a to see if it is a without_grade invalid value. If a is without_grade, it returns true. If a is normal or another invalid value, it returns false.

Example

⇒ `is_without_grade([Kr, Ag_ppm in GM: LMS1: 2x2x2])`

Explanation

If [Kr, Ag_ppm in GM: LMS1: 2x2x2] produces a without_grade status for a block, filter will be true for that block. If it produces any other invalid value or a normal value, filter will be false.

is_outside(a)

A function that tests a to see if it is an outside invalid value. If a is outside, it returns true. If a is normal or another invalid value, it returns false.

Example

 filter ⇒ `is_outside([Kr, Ag_ppm in GM: LMS1: 2x2x2])`

Explanation

If [Kr, Ag_ppm in GM: LMS1: 2x2x2] produces an outside status for a block, filter will be true for that block. If it produces any other invalid value or a normal value, filter will be false.

Mathematics

pi Constant

The constant pi is an existing item you do not need to define yourself. It is defined to 15 decimal places as 3.141592653589793.

Example

 area ⇒ `pi * [radius]^2`

Explanation

area will be calculated as pi multiplied by the square of [radius]. Note that pi is not enclosed in square brackets like user-created variables and constants, as it is an internal constant.

e Constant

The constant e, the base of the natural logarithm, is an existing item you do not need to define yourself. It is defined to 15 decimal places as 2.718281828459045.

Example

 comp ⇒ `e^[rate]-1`

Explanation

comp will be calculated as e to the power of [rate] minus 1. Note that e is not enclosed in square brackets like user-created variables and constants, as it is an internal constant.

log(n) Base 10

The common logarithm, the logarithm with base 10, i.e. $\log_{10}(n)$ or $\lg(n)$. This function will calculate the common logarithm of the value provided as n.

Example

 scaled ⇒ `log([measure])`

Explanation

scaled will be calculated as \log_{10} of [measure].

log(n, base)

The logarithm of a number n to the base base.

Example

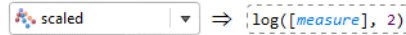

Explanation

scaled will be calculated as \log_2 of [measure].

ln(n) Natural log, base e

The natural logarithm, the logarithm with base e, i.e. $\log_e(n)$. This function will calculate the natural logarithm of the value provided as n.

Example



Explanation

scaled will be calculated as \log_e of [measure].

exp(n) Natural exponent

The natural exponent. This function will provide the result of e^n .

Example



Explanation

y will be calculated as e [measure].

sqrt(n) Square root

The principle square root of the provided number n.

Example



Explanation

y will be calculated as the square root of [measure].

abs(n) Absolute value

The absolute value of a number is its value with the sign of the number disregarded. The absolute value of -42 is 42. The absolute value of 42 is also 42.

Example



Explanation

y will be whatever [measure] is, but without its sign; it will always be positive as a result.

Limits and rounding

min(n, m, ...)

Returns the lowest of all the values in the set provided.

Example

 ⇒ min([xi], [yi], [zi])

Explanation

low will be the lowest of the three values provided, the metadata items for the X index, Y index, and Z index.

max(n, m, ...)

Returns the highest of all the values in the set provided.

Example

 ⇒ max([xi], [yi], [zi])

Explanation

high will be the highest of the three values provided, the metadata items for the X index, Y index, and Z index.

clamp(n, lower)

This clamp function tests the value n against the threshold lower and if it is less than lower the result will be lower; otherwise the result will be n. The effect is to push all the values below the threshold up to the threshold.

Example

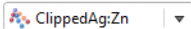
 ⇒ clamp([Ag to Zn Ratio], 0.25)

Explanation

The output for ClippedAg:Zn will range from 0.25 up to the maximum value of [Ag to Zn Ratio]. If [Ag to Zn Ratio] is less than 0.25, the output will be 0.25 instead. Otherwise, the output will be [Ag to Zn Ratio].

clamp(n, lower, upper)

This clamp function tests the value n against the threshold lower and if it is less than lower the result will be lower; it tests the value n against the threshold upper and if it is more than upper the result will be upper; otherwise the result will be n. The effect is to squish all the values into a box between the lower and upper thresholds.

Example

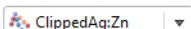
 ⇒ clamp([Ag to Zn Ratio], 0.25, 0.7)

Explanation

The output for ClippedAg:Zn will range from 0.25 up to 0.7. If [Ag to Zn Ratio] is less than 0.25, the output will be 0.25 instead. If [Ag to Zn Ratio] is more than 0.7, the output will be 0.7 instead. Otherwise, the output will be [Ag to Zn Ratio].

round(n)

This function rounds the input value n to the nearest whole number.

Example

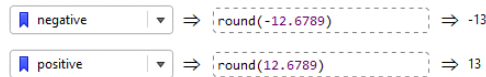

Explanation

The variable negative will be given the value -13 as the nearest whole number to -12.6789 used as the input to the function. The variable positive will be given the value 13 as the nearest whole number to 12.6789 used as the input to the function.

round(n, dp)

This function rounds the input value n to the number of decimal places specified by dp, a positive integer.

Example

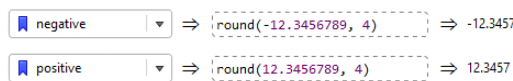

Explanation

The variable negative will be given the value -12.3457, the value of -12.3456789 rounded to 4 decimal places. The variable positive will be given the value 12.3457, the value of 12.3456789 rounded to 4 decimal places.

roundsf(n, sf)

This function rounds the input value n to the number of significant figures specified by sf, which must be a positive integer >= 1. Rounding to a given number of significant figures is often preferred in scientific applications over rounding to a given number of decimal places, as outputs can be rounded to the same amount of significance as the inputs.

Example

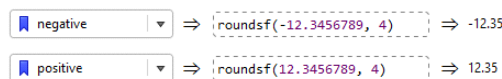

Explanation

The variable negative will be given the value -12.35, the value of -12.3456789 rounded to 4 significant figures. The variable positive will be given the value 12.35, the value of 12.3456789 rounded to 4 significant figures.

floor(n)

This function removes the fractional part of a real number n and returns the integer number below the real number n . This remains true when n is a negative number.

Example

⇒ `floor(-12.3456789)` ⇒ -13
 ⇒ `floor(12.3456789)` ⇒ 12

Explanation

The variable `negative` will be given the value -13, the integer below -12.3456789. The variable `positive` will be given the value 12, the integer below 12.3456789.

ceiling(n)

This function removes the fractional part of a real number n and returns the integer number above the real number n . This remains true when n is a negative number.

Example

⇒ `ceiling(-12.3456789)` ⇒ -12
 ⇒ `ceiling(12.3456789)` ⇒ 13

Explanation

The variable `negative` will be given the value -12, the integer above -12.3456789. The variable `positive` will be given the value 13, the integer above 12.3456789.

truncate(n)

This function simply removes the fractional part of a real number n and returns the integer number without the fractional part. This means that for positive real numbers, the result will be the integer less than the real number n , but for negative real numbers, the result will be the integer greater than the real number n .

Example

⇒ `truncate(-12.3456789)` ⇒ -12
 ⇒ `truncate(12.3456789)` ⇒ 12

Explanation

The variable `negative` will be given the value -12, the integer part of -12.3456789. The variable `positive` will be given the value 12, the integer part of 12.3456789.

Text

'abc' Text value

Use this item to add a text sequence to an expression. Selecting the item will add two single quotation marks with the cursor between, ready for the text sequence to be typed. You can of course simply type the quote marks into the expression yourself. Double quotations marks also

work identically to the single quotation marks used by this item. If you need to include a quote mark inside your text sequence, you need to "escape" the character so it is not interpreted as the end of the text sequence, by entering two quotation marks for each quotation mark you want inside the text sequence. Alternatively, you can use a different type of quotation mark as the sequence wrappers; for instance to write Leda's LMS1 with an internal apostrophe, you might wrap the sequence with double quotation marks: "Leda's LMS1".

Example



Explanation

The text sequence Leda's LMS1 (note: without the wrapping quotation marks and with only one possessive apostrophe) will be used wherever the variable name is used in expressions.

Enter text...

This selection opens a dialog box prompting you for text. After you enter it and click OK, the text will be entered at the cursor, wrapped with quotation marks. This is an easy way to resolve any issues about internal quotation marks, as the dialog box will convert the text into the necessary character sequence required to generate your desired text.

Example

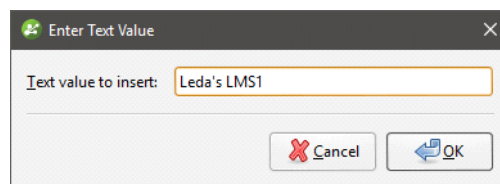

Explanation

This will produce a converted character sequence that produces a valid string and insert it to the expression at the insertion point.



concat(t, u, ...)

This concatenates a series of text sequences together.

Example

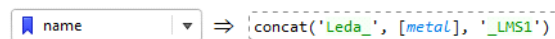

Explanation

Each of the text sequences in the input are run together and combined. If [metal] is 'Zinc' then name will be Leda_Zinc_LMS1. If [metal] is 'Silver' then name will be Leda_Silver_LMS1.

startswith(t, 'prefix')

This function returns true if the text sequence t starts with prefix, and false otherwise. This is case insensitive; 'prefix' will match 'PREFIX'.

Example

⇒ `startswith([name], 'LMS1')`

Explanation

filter will be true if [name] starts with LMS1.

endswith(t, 'suffix')

This function returns true if the text sequence t ends with suffix, and false otherwise. This is case insensitive; 'suffix' will match 'SUFFIX'.

Example

⇒ `endswith([name], '_LMS1')`

Explanation

filter will be true if [name] ends with _LMS1.

contains(t, 'part')

This function returns true if the text sequence t contains part somewhere within, and false otherwise. This is case insensitive; 'part' will match 'PART'.

Example

⇒ `contains([name], 'LMS')`

Explanation

filter will be true if [name] contains LMS somewhere within the character sequence.

like(t, 'pattern')

This function returns true if the text sequence t matches pattern, where [pattern] follows SQL-style LIKE matching rules. This is case insensitive, and pattern must match the whole of t, not just a portion of it. Use `_` as a wildcard for a single character, and `%` as a wildcard for any number of characters (including no characters).

Example

⇒ `like([name], '%LMS_Leda%')`

Explanation

filter will be true if [name] matches the pattern `%LMS_Leda%`. Examples of [name] that will match include:

- LMS1Leda
- LMS1LEDA
- LMS2Leda
- MoreLMS1Leda
- LMS3LedaExtra
- #lmsXleda#

Examples that will not match include:

- LMS12Leda
- LM1SLeda
- LMSLeda

regexp(t, 'pattern')

This function returns true if the text sequence t matches pattern, where [pattern] is follows regular expression matching rules. This is case insensitive.

Example

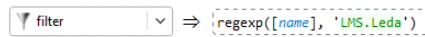

Explanation

filter will be true if [name] matches the regexp pattern LMS.Leda. Examples of [name] that will match include:

- LMS1Leda
- LMS1LEDA
- LMS2Leda
- MoreLMS1Leda
- LMS3LedaExtra
- #lmsXleda#

Examples that will not match include:

- LMS12Leda
- LM1SLeda
- LMSLeda

Unit conversion

Mass/weight...

This selection opens a dialog box prompting for the **From Unit** and **To Unit** for the conversion.

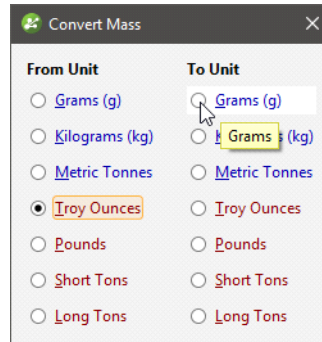

When you have selected the two units, the dialog box disappears and the conversion function you require will have been inserted into the expression at the cursor, and the cursor repositioned so you can enter the source of the value to be converted.

Example

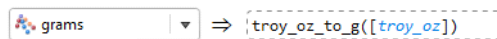

Explanation

The `troy_oz_to_g` function has been entered by the dialog box, and the variable `[troy_oz]` has been entered as the input. The numeric calculation `grams` will be given the output of the `troy_oz_to_g` function.

Distance...

This selection opens a dialog box prompting for the **From Unit** and **To Unit** for the conversion.

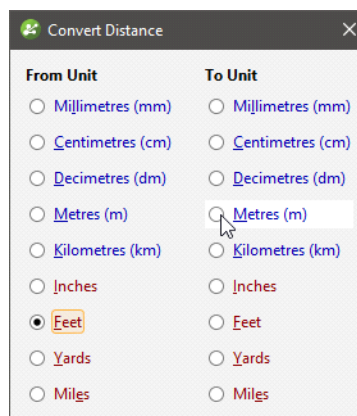

When you have selected the two units, the dialog box disappears and the conversion function you require will have been inserted into the expression at the cursor, and the cursor repositioned so you can enter the source of the value to be converted.

Example



Explanation

The ft_to_m function has been entered by the dialog box, and the variable [feet] has been entered as the input. The numeric calculation metres will be given the output of the ft_to_m function.

Area...

This selection opens a dialog box prompting for the **From Unit** and **To Unit** for the conversion.

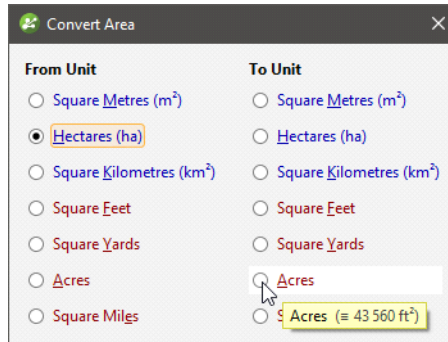

When you have selected the two units, the dialog box disappears and the conversion function you require will have been inserted into the expression at the cursor, and the cursor repositioned so you can enter the source of the value to be converted.

Example

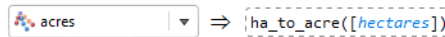

Explanation

The ha_to_acre function has been entered by the dialog box, and the variable [hectares] has been entered as the input. The numeric calculation acres will be given the output of the ha_to_acre function.

Volume...

This selection opens a dialog box prompting for the **From Unit** and **To Unit** for the conversion.

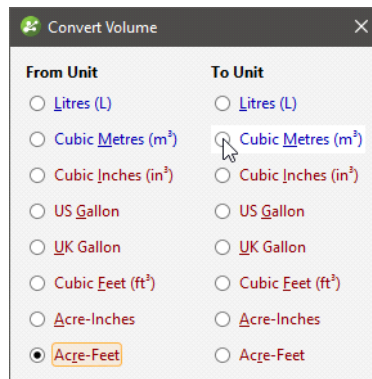

When you have selected the two units, the dialog box disappears and the conversion function you require will have been inserted into the expression at the cursor, and the cursor repositioned so you can enter the source of the value to be converted.

Example

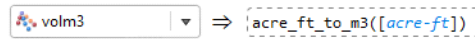

Explanation

The acre_ft_to_m3 function has been entered by the dialog box, and the variable [acre-ft] has been entered as the input. The numeric calculation volm3 will be given the output of the acre_ft_to_m3 function.

Temperature...

This selection opens a dialog box prompting for the **From Unit** and **To Unit** for the conversion.

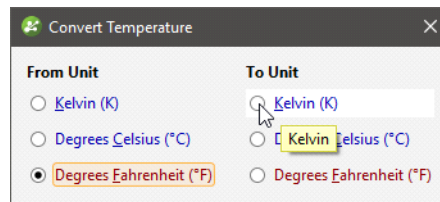

When you have selected the two units, the dialog box disappears and the conversion function you require will have been inserted into the expression at the cursor, and the cursor repositioned so you can enter the source of the value to be converted.

Example

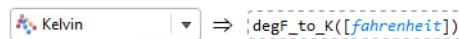

Explanation

The degF_to_K function has been entered by the dialog box, and the variable [fahrenheit] has been entered as the input. The numeric calculation Kelvin will be given the output of the degF_to_K function.

Pressure...

This selection opens a dialog box prompting for the **From Unit** and **To Unit** for the conversion.

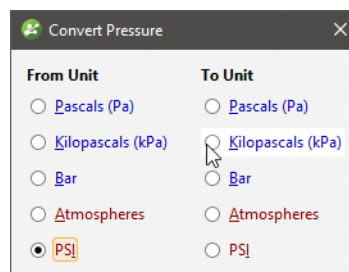

When you have selected the two units, the dialog box disappears and the conversion function you require will have been inserted into the expression at the cursor, and the cursor repositioned so you can enter the source of the value to be converted.

Example

⇒ `psi_to_kPa([pressure_psi])`

Explanation

The psi_to_kPa function has been entered by the dialog box, and the variable [pressure_psi] has been entered as the input. The numeric calculation pressure_kPa will be given the output of thepsi_to_kPa function.

Energy...

This selection opens a dialog box prompting for the **From Unit** and **To Unit** for the conversion.

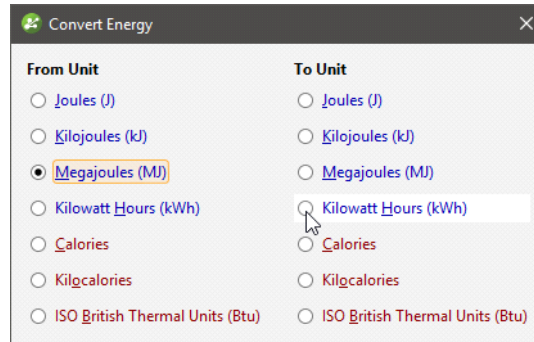

When you have selected the two units, the dialog box disappears and the conversion function you require will have been inserted into the expression at the cursor, and the cursor repositioned so you can enter the source of the value to be converted.

Example

⇒ `MJ_to_kWh([MegaJoules])`

Explanation

The MJ_to_kWh function has been entered by the dialog box, and the variable [MegaJoules] has been entered as the input. The numeric calculation kiloWatt Hours will be given the output of theMJ_to_kWh function.

Block Estimate Interrogation

The features described in this topic are only available if you are licensed to use Leapfrog Edge with Leapfrog Geo.

It is good practise to check the estimates produced for blocks, inspecting the data used to create the estimate. The block estimate interrogator exposes the data used to produce an estimate. Right-click on a block model in the project tree and select **Interrogate Estimator**.

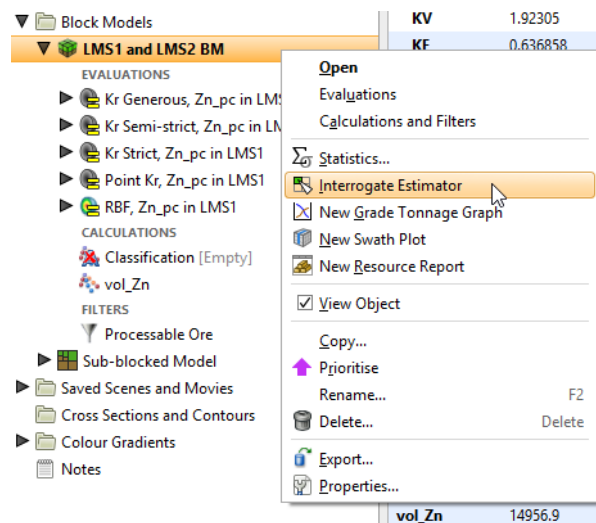

The **Block Model Interrogation** window will open as a dockable tab, showing the input data used in producing the estimates and other results. Additionally, in the scene view, the block details window will display inside the scene, containing properties for the currently selected block. These are primarily result properties.

Use the filter selector () to see all the **Found** data points in the block estimate interrogator table, or only the data points **Included** in the estimate, or only the data points that are **Clamped**. The **Clamped** option will only be present if **Outlier Restrictions** are being used by the estimator.

You can change the **Estimator** to select between the inverse distance and Kriging estimators evaluated on the block model. Other estimators are not supported by the block model interrogation feature.

Click the **Open Estimator** button to inspect the estimator used in the estimate. This will open in a new window.

View Ellipsoid will display the search ellipsoid in the scene. If **Octant Search** or **Quadrant Search** is not used in the estimator, the axial planes of the ellipsoid are shaded, which helps to visualise the 3-dimensional shape of the ellipsoid as well as its orientation. If **Octant Search** or **Quadrant Search** is being used, the planes that divide the ellipsoid into sectors are shown as an aid to understanding the sector search areas.

Click a block in the scene or set the **Block Index Definition X, Y and Z** coordinates to select a specific block.

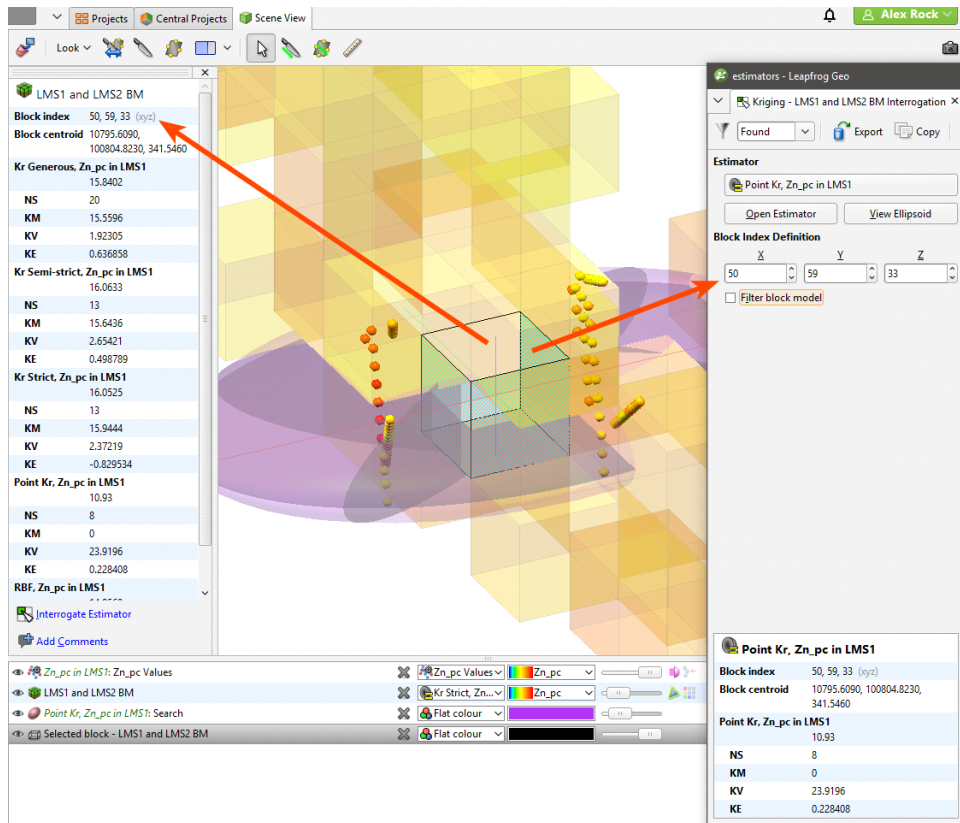

Enable **Filter block model** to see only the selected block in the scene, which will reduce the visual noise of all the other blocks. This will help you see the associated data points and the search ellipsoid in relation to the selected block:

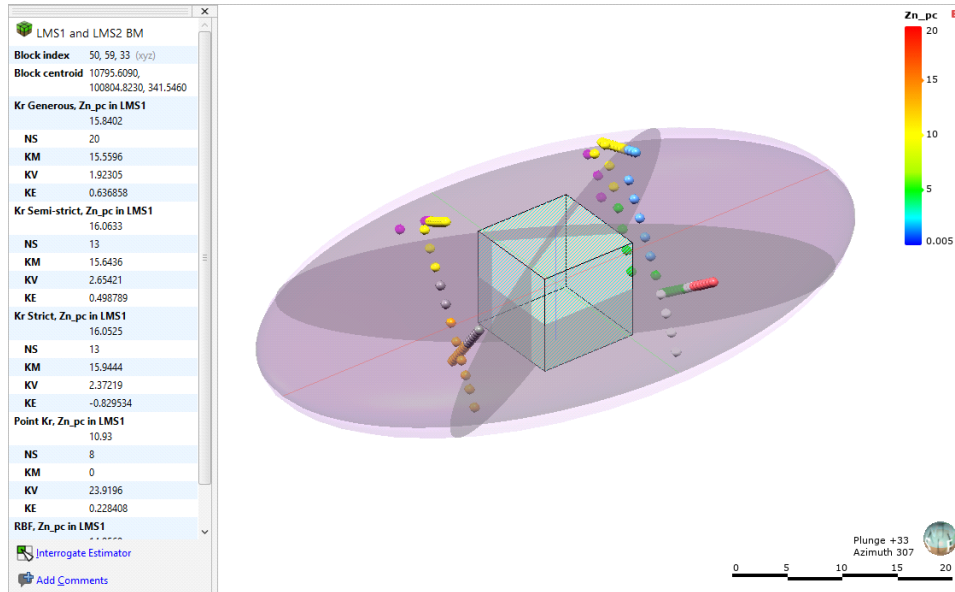

In the block estimate table, you will see all the input data columns for each data point. Data points can be hidden or made visible in the scene using the visibility button (☺).

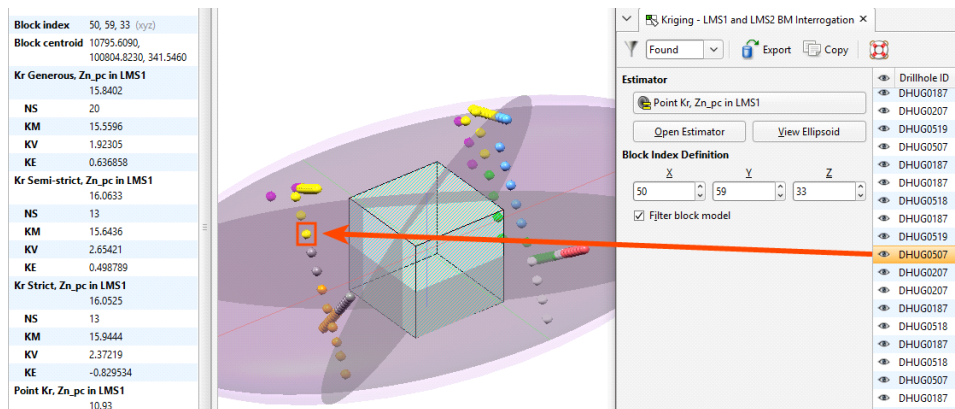

Block information is shown in the bottom left corner of the **Block Model Interrogation** window, so it is not necessary to refer back to the scene and select the block information for the appropriate block.

In the **Weights** column, negative values are highlighted in red to make them easier to see.

Drillhole ID	X	Y	Z	Zn_pc Values	Weights	Included	Distance
DHUG0518	10796.34	100814.40	332.49	11.54	-0.0058	Yes	13.20
DHUG0206	10792.86	100795.78	350.40	20.15	-0.0045	Yes	12.96
DHUG0206	10792.11	100796.14	349.85	19.23	-0.0035	Yes	12.51
DHUG0206	10793.61	100795.41	350.96	20.92	-0.0013	Yes	13.46
DHUG0206	10791.37	100796.51	349.30	19.15	-0.0020	Yes	12.13
DHUG0206	10794.35	100795.04	351.52	15.62	-0.0006	Yes	14.02
DHUG0206	10790.62	100796.88	348.75	18.85	-0.0008	Yes	11.83
DHUG0206	10795.10	100794.68	352.07	12.38	-0.0005	Yes	14.63
DHUG0206	10789.87	100797.25	348.19	19	0.0028	Yes	11.60
DHUG0518	10797.69	100813.88	331.11	12.92	0.0002	Yes	13.97
DHUG0206	10795.84	100794.31	352.63	13.38	-0.0002	Yes	15.28
DHUG0206	10789.12	100797.62	347.65	18	0.0093	Yes	11.46
DHUG0518	10794.99	100814.92	333.87	15.23	0.0133	Yes	12.69
DHUG0206	10796.59	100793.95	353.19	12.46	0.0003	Yes	15.96
DHUG0206	10788.37	100797.99	347.10	16.92	0.0087	Yes	11.40
DHUG0206	10797.33	100793.58	353.75	11	0.0005	Yes	16.68
DHUG0206	10787.62	100798.36	346.55	13.69	0.0080	Yes	11.43
DHUG0206	10786.86	100798.73	346.01	14.46	0.0108	Yes	11.56
DHUG0206	10798.07	100793.22	354.32	10.77	0.0006	Yes	17.43

If **Octant Search** or **Quadrant Search** is being used within an estimator, points within the search ellipsoid can be coloured according to their search sector. Select the **Sector** option from the view list in the point value properties.

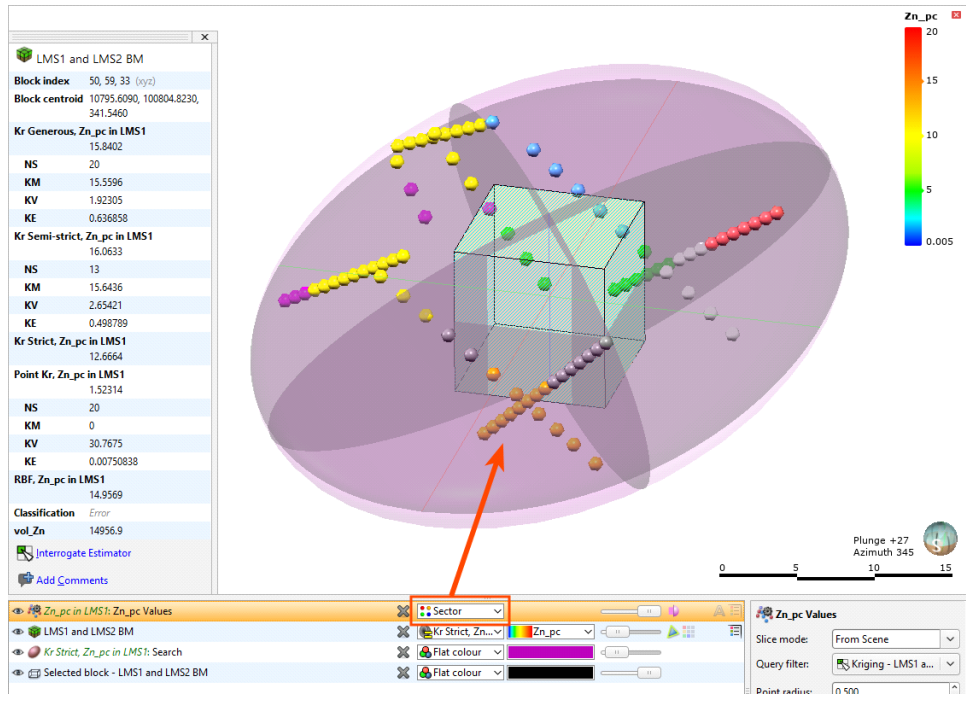

The block estimate interrogator table data can be exported for use in other programs such as Microsoft Excel. Click the **Export** button to save a CSV file, which will include the table data and the search statistics (found, clamped, included, equidistant, duplicates, etc) and the block information (index, centroid, Kriging attributes, etc). Click the **Copy** button to put a copy of the table data on the operating system clipboard, and you can then paste it into another program.

Grade Tonnage Graphs

The features described in this topic are only available if you are licensed to use Leapfrog Edge with Leapfrog Geo.

A grade tonnage curve combines two or three equations together to produce one of the more important tools for analysing the data indicating the potential amount of material obtained when varying the cut-off grade applied.

Leapfrog Geo can display multiple grade tonnage curves on one graph.

To create a grade tonnage graph, right click on a block model and select **New Grade Tonnage Graph**:

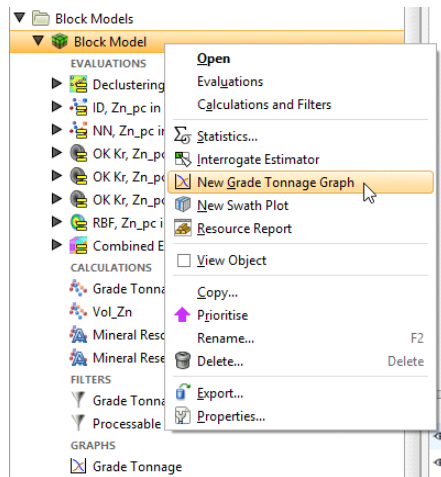

A new **Grade Tonnage** window will open:

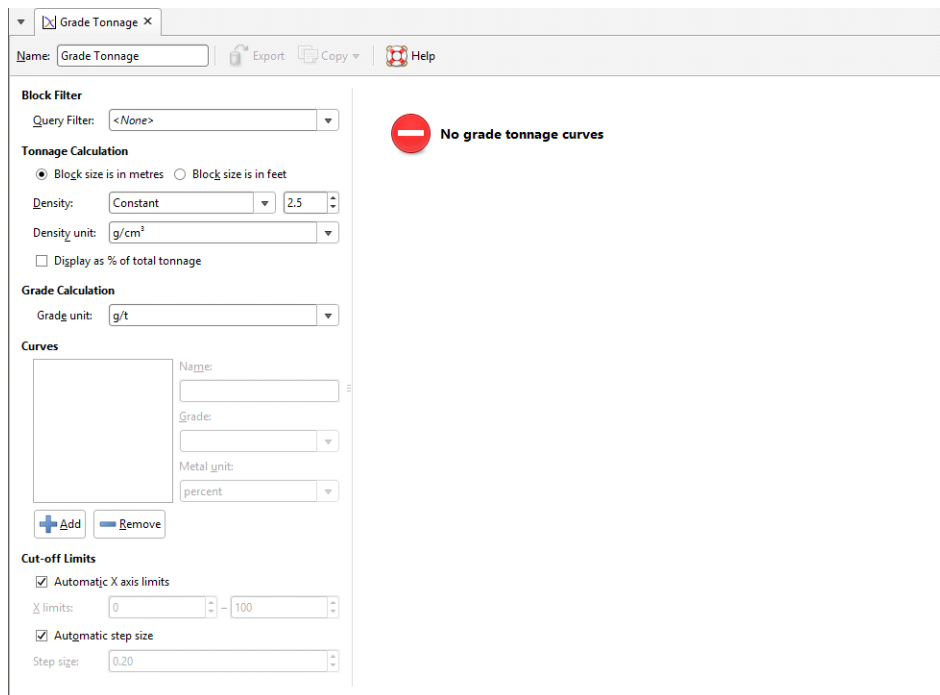

You can select a **Block Filter** query by choosing a filter from the **Query Filter** list. To add a new filter to this list, create a new filter in **Calculations**. See [Filters](#) and the subsequent sections in [Calculations and Filters on Block Models](#) for more information.

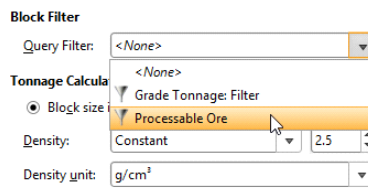

There are several **Tonnage Calculation** settings.

Select between the **Block size is in metres** and **Block size is in feet** options, as appropriate for your data.

The **Density** can be set to a specified **Constant**, or one of the numerical data columns in the data can be selected, perhaps to provide a calculated density for each block.

Select the **Density unit** as appropriate. The options are: **g/cm³**, **t/m³**, **lb/ft³**, **sh. ton/ft³**, **ft³/sh. ton**.

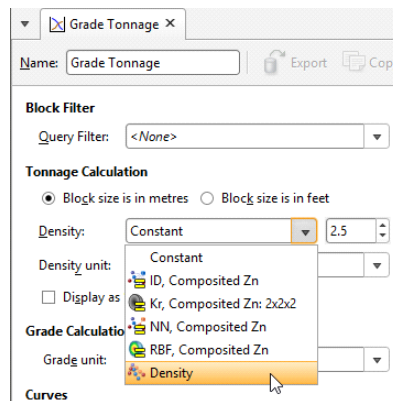

Tick the **Display as % of total tonnage** checkbox to view as a percentage instead of a measure. This only changes the scale on the chart; exported data is not modified.

Select the desired **Grade unit** for the **Grade Calculation**.

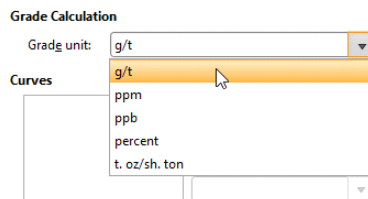

Multiple grade tonnage **Curves** can be added. Initially there are none listed. Click the **Add** button to add a new curve. Provide an identifying **Name** for the curve, and select the **Grade** calculation from the list of numeric columns in the data. If you need to write a grade calculation, you can add it as a numeric calculation in **Calculations**. See [Numeric Calculations](#) and the subsequent sections in [Calculations and Filters on Block Models](#) for more detail.

Curves

Name: Zn

Grade: RBF, Zn_p...GM: LMS1

+ Add - Remove

Cut-off Limits

Automatic X axis limits

X limits: 0 - 19

The **Metal unit** field does not change any aspect of the grade tonnage chart. It selects the metal unit that will be exported with the grade tonnage calculation data when **Copy Data** is selected.

Curves

Name: Zn

Grade: RBF, Zn_p...GM: LMS1

Metal unit: t

+ Add - Remove

Cut-off Limits

Automatic X axis limits

X limits: 0 - 19

Once a curve is selected, a graph will be generated, using the automatic **Cut-off Limits**. You can manually override these by unticking **Automatic X axis limits** and specifying your preferred minimum and maximum **X limits**, and/or by unticking **Automatic step size** and specifying a preferred **Step size**.

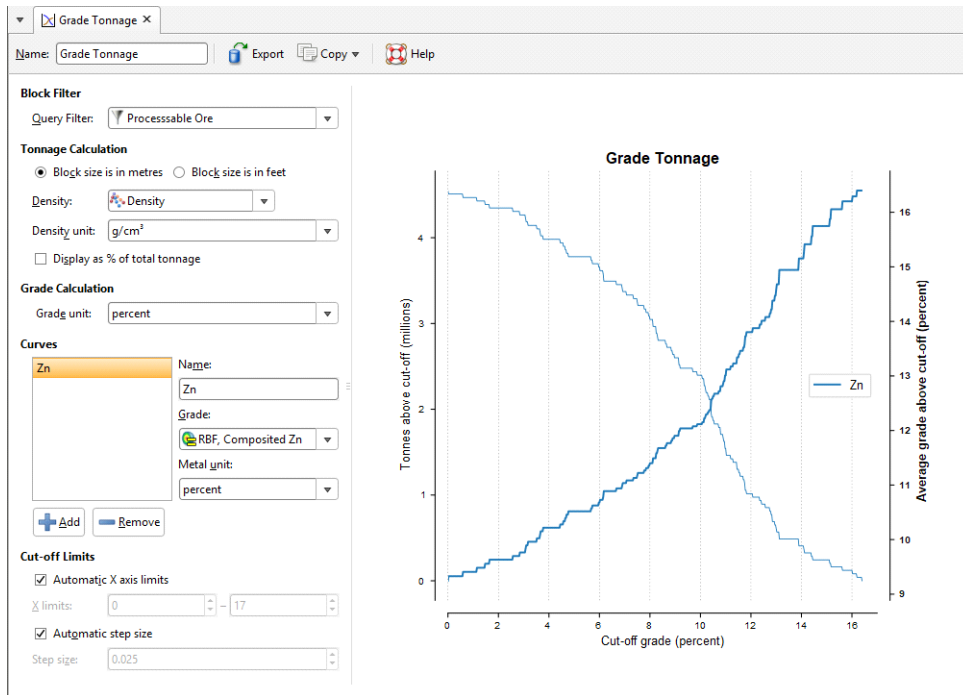

You can click the **Add** button under **Curves** to add more grade tonnage curves to the graph.

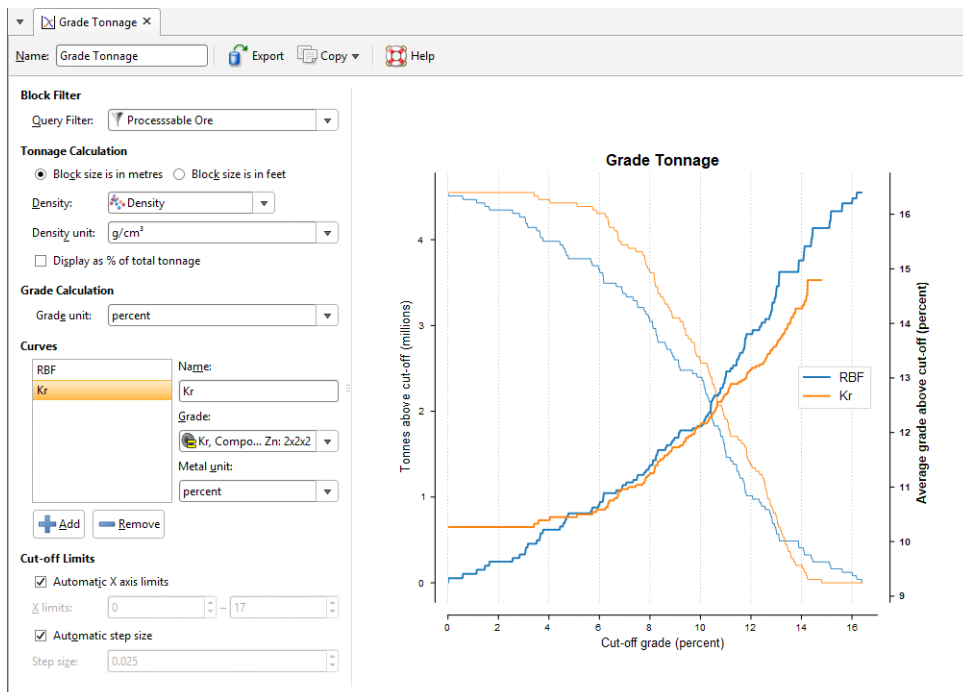

Provide a **Name** for the grade tonnage graph in the window's toolbar.



The **Export** button in the window's toolbar saves the current grade tonnage graph as a PDF file. You will be asked to provide a file name and storage location for the new PDF file.

The **Copy** button provides two additional ways to export grade tonnage graph information:

- The **Copy Graph Image** will put an image on the operating system clipboard at the selected quality: **Screen Quality**, **Medium Quality, 300 dpi**, or **High Quality, 600 dpi**.
- The **Copy Data** option will put CSV data on the operating system clipboard.

The objects on the clipboard can then be pasted into other applications you are using, such as Microsoft Word or Microsoft PowerPoint.

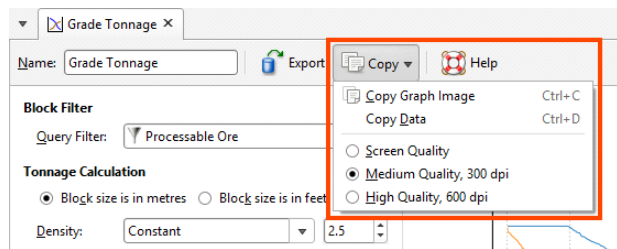

Swath Plots

The features described in this topic are only available if you are licensed to use Leapfrog Edge with Leapfrog Geo.

Swath plots are an important validation tool for providing comparisons between sample points (composited or uncomposited) and estimated values to identify any bias towards under-estimation or over-estimation or any smoothing in the results. The effect of different estimation methods and parameters can also be compared.

The swath plot is a one-dimensional graph in a specific direction of interest. A swath is a sectional slice through the block model with a specified thickness. The swath plot shows the average grade for the blocks in the swath, along with the averaged sample values in the swath.

To create a swath plot, right-click on a block model and select **New Swath Plot**:

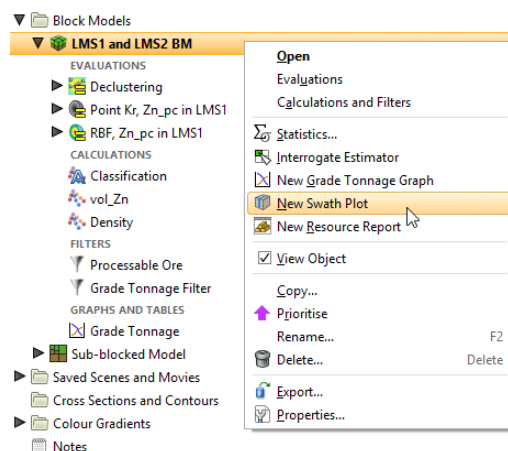

A new **Swath** window will open:

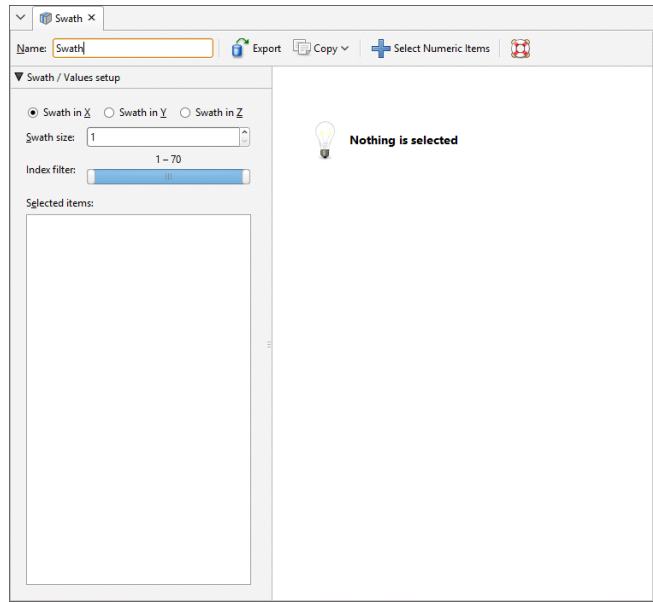

Click **Select Numeric Items** to add data sets to the plot. You can select individual items from the list of **Available Numeric Items** or you can select a parent object to select all the child items within it. Click the right arrow button to move the selected items into the **Selected Numeric Items** list:

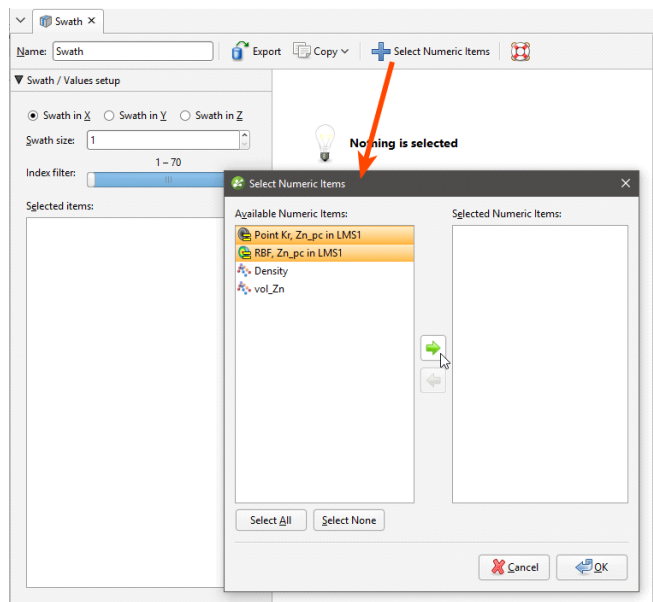

The graph plots the averaged sampled values against the averaged block grades for a series of swaths slicing through the block model in a selected direction. The **Swath size** can be altered for finer or more coarse slices. The **Scene** view overlays a bounding cuboid that shows the **Swath size** and direction:

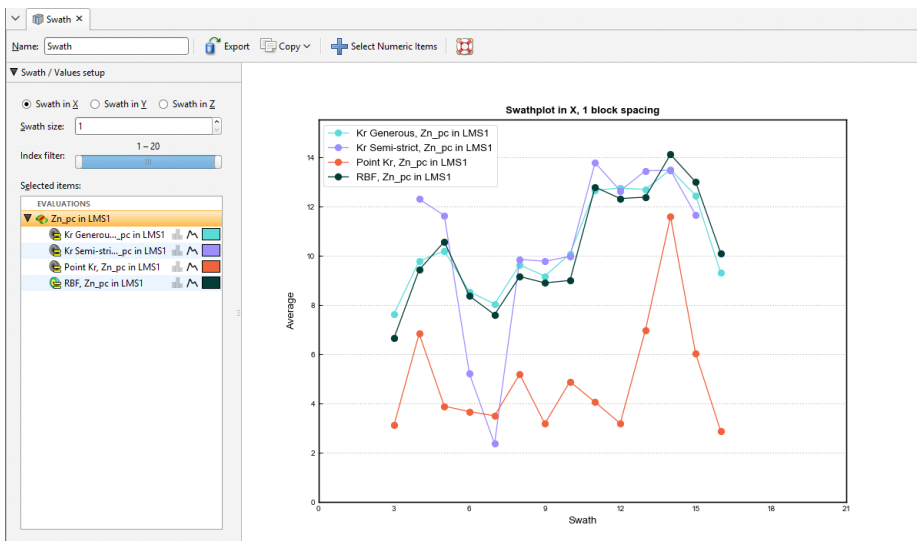

Changing the swath direction to **Swath in Y** is reflected in the scene:

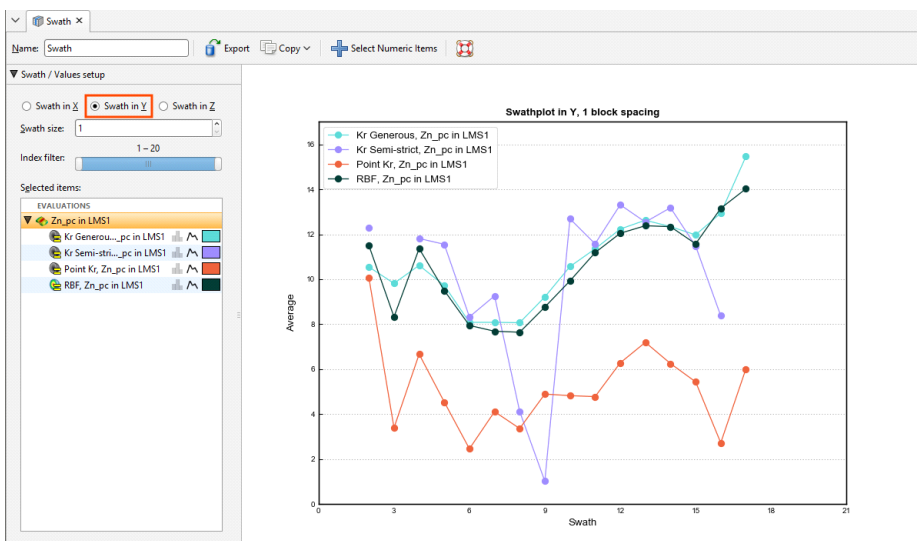

The **Index filter** can be used to graph a reduced set of the swaths. Either the minimum or maximum threshold for the **Index filter** can be dragged to change the width of the filter, and the selected portion can be changed by sliding the inner bar. The swath indicator widget in the **Scene** is updated to show what the **Swath plot** is depicting:

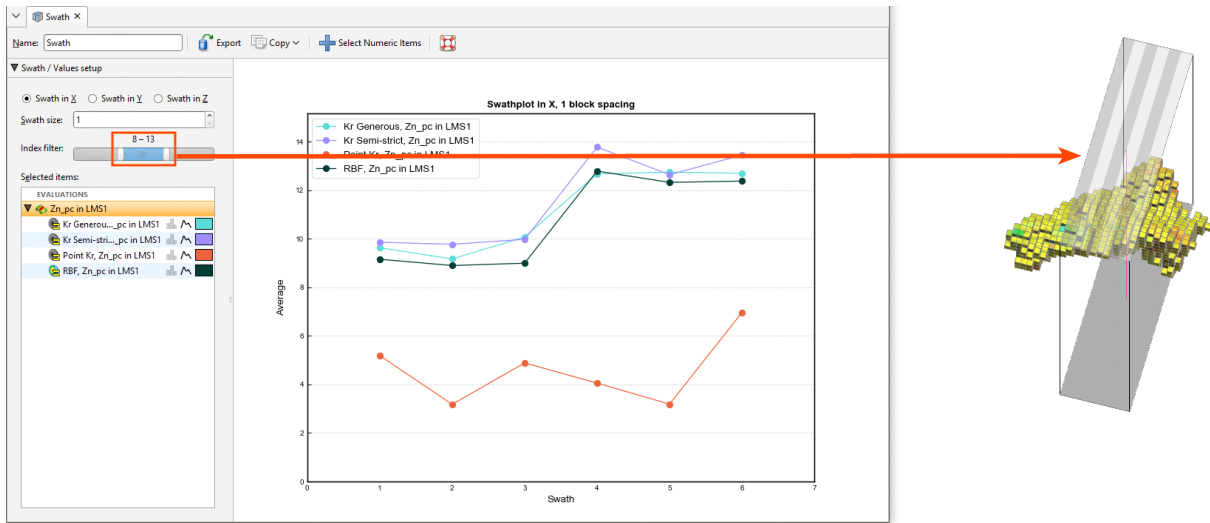

Selected data sets in the chart can be hidden or revealed by clicking the line segment visibility button (⏏) next to the data set. The histogram visibility button (📊) will reveal or hide a histogram showing the volume of blocks used in the swath calculation. The block volume may not be identical for all estimators.

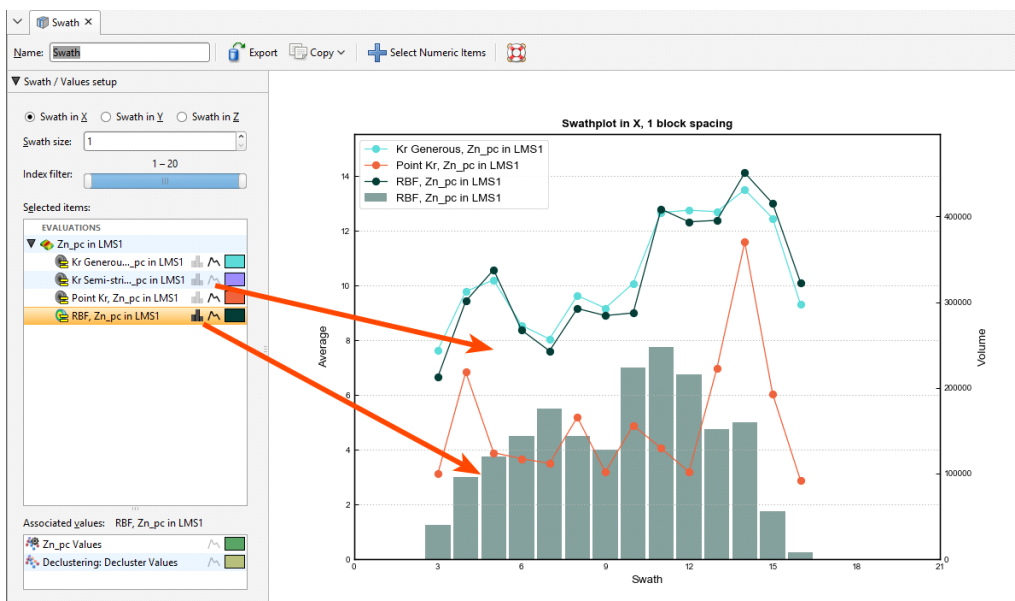

The colour for the line segment plots and histograms can be changed for each data set by clicking the colour chip, and selecting a new colour from the colour picker:

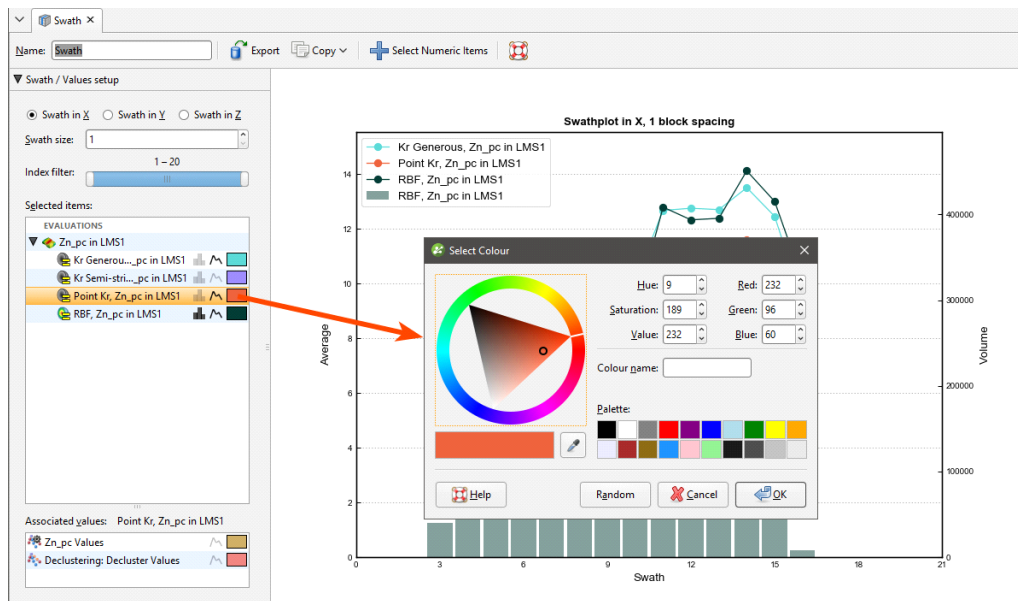

Selecting an evaluation will show an **Associated Values** panel. This provides options to set the visibility and colour preference for the evaluation's raw data values and declustered values for the evaluation's input data. Declustered values will only be shown as an associated value if a declustering object has been added to the domained estimation.

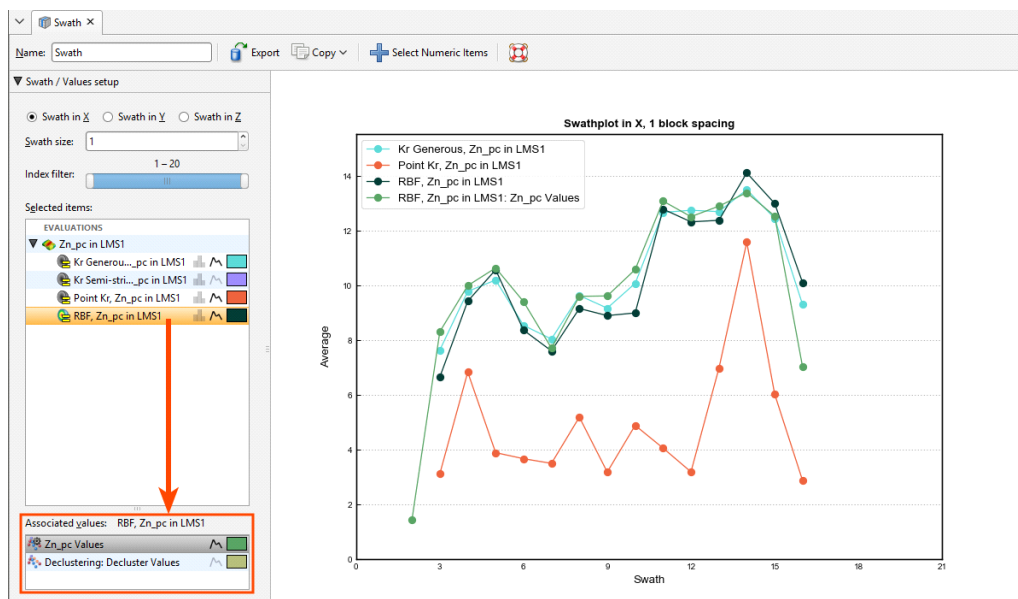

Changes you make to swath plots are preserved. Multiple swath plots can be created to show different points for analysis and reference.

You can export the graph for use in external reports and other documents. There are three options:

- The **Export graph image** button (🖨️) saves a PDF, SVG or PNG file of the graph.
- The **Copy** button (📄) opens a menu to offer the options of copying a image of the graph to the Windows clipboard, or copying the graph data as CSV data to the Windows clipboard,

where they can be pasted into another application. It also allows you to select the resolution of a copied image: a low resolution **Screen Image**, a **Medium Quality, 300 dpi** image, or a **High Quality, 600 dpi** image. Choose your preferred resolution before selecting **Copy Graph Image**.

Resource Reports

The features described in this topic are only available if you are licensed to use Leapfrog Edge with Leapfrog Geo.

The resource report is a pivot table for reporting on resources and reserves in accordance with standards, with the freedom to customise the table to the unique needs of the project requirements. A resource report can display multiple categories and multiple numeric columns.

To create or view a resource report, right-click on a block model in the project tree and select **Resource Report**. In the window that appears, click the **Select Columns** button to choose from the **Category** and **Grade** columns evaluated onto the block model. If you wish to set a **Cut-off** value, select from any numeric column evaluated on the block model and set the cut-off value. The column selected for the **Cut-off** does not need to be a column included in the resource report. You can also apply a **Filter** to the report.

Select between **Block size in metres** and **Block size in feet** to ensure units are correctly converted. Select **Constant** value from the list of **Density** options and specify a numeric constant, or select a density data measurement from the numeric columns listed. Specify the appropriate **Density unit** to match the **Density** selection.

You can also choose to **Show metal content** columns, **Show empty rows**, **Show volume column** and **Show density column**.

The screenshot shows the 'Resource Report' window with the following settings:

- Name: Resource Report
- Title: Resource Report
- Cut-off: <None> (0.00)
- Filter: No Negative Kriging
- Options:
 - Show metal content:
 - Show empty rows:
 - Show volume column:
 - Show density column:
- Column Properties: Nothing selected

Depletion Model	Classification	Volume m ³	Density g/cm ³	Tonnes t	Average Grade		Metal Content	
					Kr Generous, Zn, pc in LMS1 %	RBF, Zn, pc in LMS1 %	Kr Generous, Zn, pc in LMS1 t	RBF, Zn, pc in LMS1 t
In Design	Indicated	853,000.00	2.50	2,132,500.00	12.12	12.22	258,552.71	260,551.02
	Inferred	576,000.00	2.50	1,440,000.00	8.40	7.39	120,973.16	106,467.60
	Measured	117,000.00	2.50	292,500.00	15.01	15.96	43,916.07	46,671.72
	Waste	28,000.00	2.50	70,000.00	4.90	3.26	3,432.76	2,281.01
	Total	1,574,000.00	2.50	3,935,000.00	10.85	10.57	426,874.69	415,971.35
Mined	Indicated	129,000.00	2.50	322,500.00	12.13	12.27	39,111.28	39,582.66
	Inferred	73,000.00	2.50	182,500.00	9.00	8.04	16,424.76	14,681.07
	Measured	33,000.00	2.50	82,500.00	15.25	16.24	12,582.21	13,400.83
	Waste	8,000.00	2.50	20,000.00	12.02	12.89	2,403.25	2,577.97
	Total	243,000.00	2.50	607,500.00	11.61	11.56	70,521.49	70,242.53
Total	Indicated	982,000.00	2.50	2,455,000.00	12.12	12.23	297,663.99	300,133.68
	Inferred	649,000.00	2.50	1,622,500.00	8.47	7.47	137,397.91	121,148.68
	Measured	150,000.00	2.50	375,000.00	15.07	16.02	56,498.27	60,072.55
	Waste	36,000.00	2.50	90,000.00	6.48	5.40	5,836.01	4,858.98
	Total	1,817,000.00	2.50	4,542,500.00	10.95	10.70	497,396.18	486,213.88

Differences may occur in totals due to rounding.

If you have an estimator that produces **outside**, **blank**, **without_grade** or **error** statuses for blocks, these will result in **#Invalid** entries in the resource report table. To address this:

- Create a filter (or modify your existing filter) to discard blocks with an invalid status, and select this filter in the **Filter** field above the resource report table, or

- Create a calculation that sets invalid values to an appropriate acceptable value, and select this column instead.

Click on a column to customise how the information is displayed. You can change the column title by editing the **Heading** field.

Enabling **Show total** will add a category row called **Total** with a summation for the categories. Any row that is a summation of categories will appear in bold in the table. It is possible to get a sub-total of some of the categories by grouping them, and these will also be shown in bold. To group categories, select multiple items in the **Visible categories** list by holding down the Ctrl key as you click the mouse. Click the **Group** button to add the new category.

The screenshot shows the 'Resource Report' software interface. On the left, there are several panels: 'Blocks' (with options for block size and density), 'Options' (with checkboxes for showing metal content, empty rows, volume column, and density column), 'Column Properties' (with a heading field set to 'Classification' and a 'Show total' checkbox), and 'Visible categories' (a list of categories with checkboxes). The 'Visible categories' list includes Measured, Indicated, Measured & Indicated, Inferred, Waste, and M&I&I. An orange arrow points from the 'Group' button at the bottom of this list to the 'Total' row in the table. The table has columns for Depletion Model, Classification, Volume, Density, Tonnes, Average Grade (Kr Generous, Zn_pc in LMS1, RBF, Zn_pc in LMS1), and Metal Content (Kr Generous, Zn_pc in LMS1, RBF, Zn_pc in LMS1). The table is divided into 'In Design' and 'Mined' sections. The 'Total' row for 'In Design' is bolded. Below the table, a note states: 'Differences may occur in totals due to rounding.'

Note that some of the **Visible categories** can be unticked to hide them; these hidden categories can still be included in a grouped category:

This is a close-up of the 'Visible categories' list. It shows a list of categories with checkboxes: Measured (checked), Indicated (checked), Measured & Indicated (checked), Inferred (unchecked), Waste (unchecked), and M&I&I (checked). The 'M&I&I' category is highlighted in orange. Below the list are three buttons: an up arrow, a down arrow, and a 'Group' button.

Select a category and click the up or down buttons to reorder them in the list. Delete a grouped category by selecting it and clicking the **Delete** button (🗑).

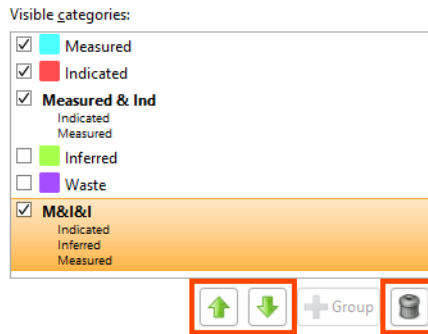

If there are multiple category columns, these can be reordered to select one as the primary categorisation, with the others shown as sub-categories. Click anywhere in a category column and drag it to a new location. While you hold down the mouse button, a vertical bar will appear where the column will be inserted:

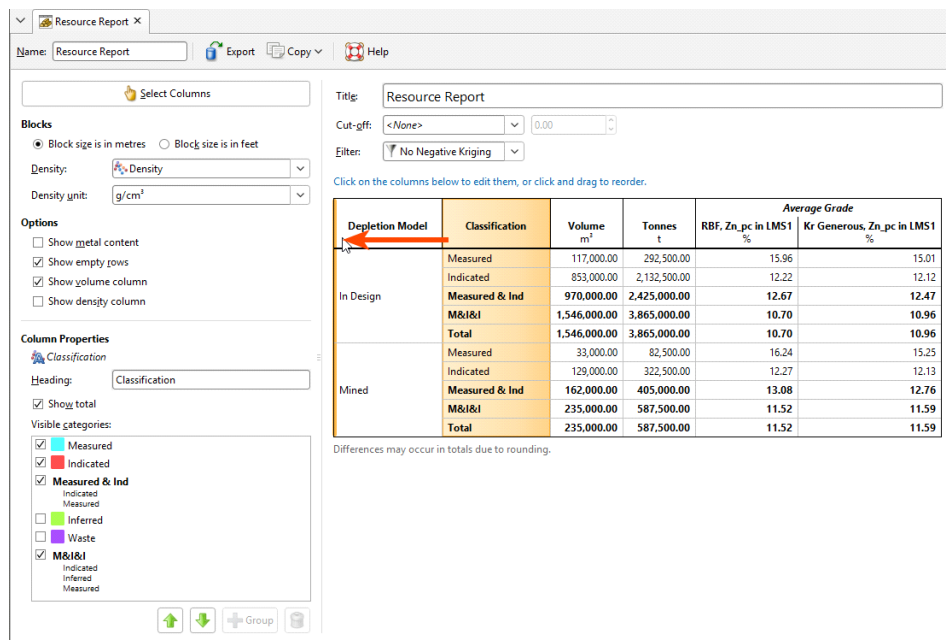

When **Average Grade** columns are selected, it is possible to change:

- The **Heading**
- The **Data unit**
- The **Display unit** to use in the table, which may be the **Same as data** or some other unit to convert to
- The number of **Decimal places** to display in the table

Data unit has the options **Unknown, Grams per tonne, Parts per million, Parts per billion, Percent, Troy ounces per short ton, Dollars per tonne** and **Dollars per short ton**. The **Data unit** may be automatically set based on indicators in the selected column name, but must be checked for correctness. Make sure that the column data matches the **Data unit** selected. Note that "dollars" is used as a general term to refer to whichever currency you are using.

When **Dollars per tonne** or **Dollars per short ton** are selected as the **Data unit**, the **Display unit** option is not selectable, and must be **Same as data**.

Metal Content columns can have the **Heading** changed, as well as the column's **Unit** and **Decimal places**.

Depletion Model	Classification	Volume m ³	Tonnes t	Average Grade	
				RBF, Zn_pc in LMS1 %	Kr Generous, Zn_pc in LMS1 %
In Design	Measured	117,000.00	292,500.00	15.96	15.01
	Indicated	853,000.00	2,132,500.00	12.22	12.12
	Measured & Ind	970,000.00	2,425,000.00	12.67	12.47
	Total	1,546,000.00	3,865,000.00	10.70	10.96
Mined	Measured	33,000.00	82,500.00	16.24	15.25
	Indicated	129,000.00	322,500.00	12.27	12.13
	Measured & Ind	162,000.00	405,000.00	13.08	12.76
	Total	235,000.00	587,500.00	11.52	11.59

Differences may occur in totals due to rounding.

The **Resource Report** tab has **Export** and **Copy** options for making use of the report in external documents.

- Select **Export** to save the table as a Microsoft Excel spreadsheet, a CSV file, or an HTML file. Formatting is preserved in the spreadsheet and HTML file so the table will be arranged identically to the report in Leapfrog Geo. CSV files do not contain formatted data. If you select CSV, you will also be asked if you would like to use the **Rounded numbers** used in the table, or **Full precision** numbers. You can also select between **ASCII characters only** and **Allow all characters, with UTF-8 encoding**, as required by the software you are exporting to.
- If you select **Copy**, then **Copy Table**, the table is copied to the operating system clipboard, and you can paste it into another application such as Microsoft Excel or Microsoft Word. Formatting is preserved so the table will be arranged identically to the report in Leapfrog Geo and only the column and row sizes need to be adjusted to your preferences.

Reports you create appear in the **Graphs and Tables** section under the relevant block model. To delete a report, right-click the report and select **Delete** from the context menu.

Presentation

Leapfrog Geo has a number of tools for displaying and presenting data for use in reports and presentations.

- Share models and data to View, a web-based model sharing platform that allows you to visualise 3D models and share them with collaborators. See [Uploading to View](#).
- Create and export cross sections, fence sections and serial sections. See [Sections](#).
- Create and export contours. See [Contour Lines](#).
- Render and save images for use outside of Leapfrog Geo. See [Rendered Images](#).
- Save scenes that demonstrate different aspects of the model and the model-building process. These scenes can then be saved as a movie or as a scene file that can be opened in Leapfrog Viewer. See [Saved Scenes](#).

See [Visualising Data](#) for information about the tools available in Leapfrog Geo for changing how data is displayed.

Uploading to View

View is a web-based model sharing platform. You can upload Leapfrog Geo data to View, visualise the data and organise it into slides. You can also share views with collaborators, all in your web browser, with data saved securely to the cloud. All your collaborators need is a My Leapfrog ID; a Leapfrog Geo licence is not required.

There are two workflows for uploading data from Leapfrog Geo to View, uploading the data currently displayed in the 3D scene and uploading saved scenes. Both techniques are described below, but first it is important to understand how View handles data objects uploaded from Leapfrog Geo.

In this Leapfrog Geo scene, we have a number of data objects, including a topography, drilling data, a geological model and its contact surfaces, plus grade shells from a numeric model. Data is sliced.

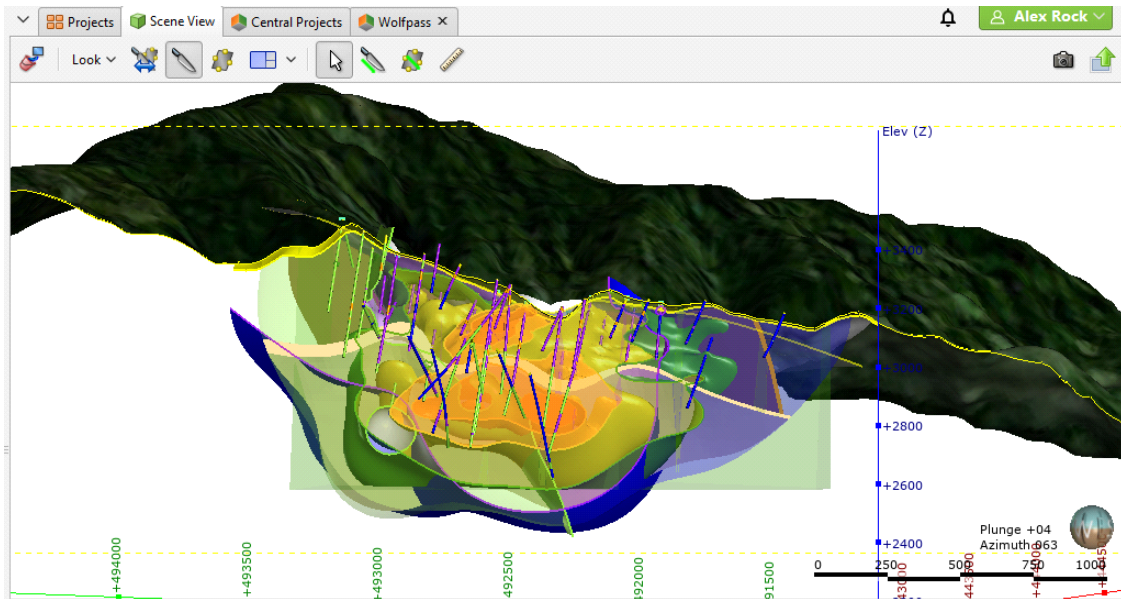

In View, all elements from the Leapfrog Geo scene are displayed in the initial view, which is unsliced. View's slice tool is similar to the slicer in Leapfrog Geo, and you can also rotate, pan and zoom the view and measure elements.

With the **Elements** list, you can select which objects to display and how they are displayed:

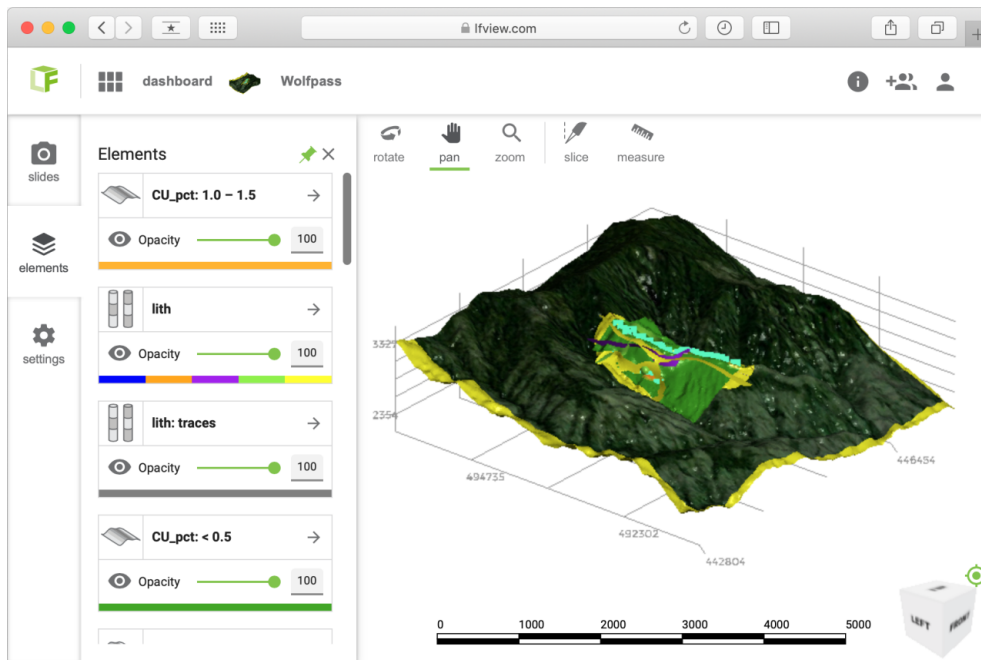

Once you have set up a view, save it as a slide. In this way, you can organise your data to tell a story and invite feedback from collaborators.

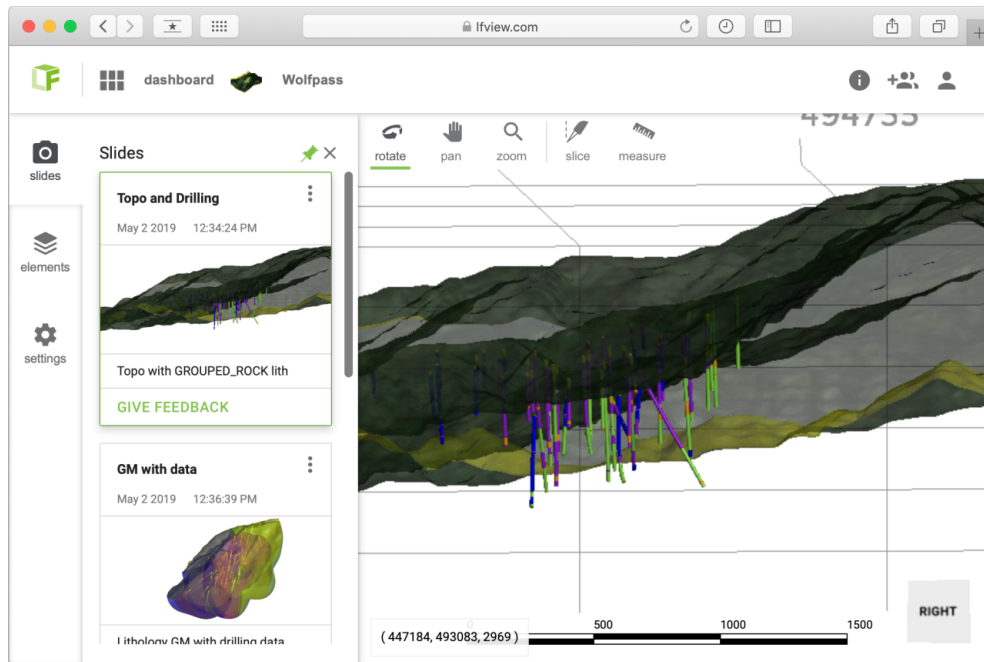

If you have permission to edit the view, you can add feedback and annotations and can create new slides:

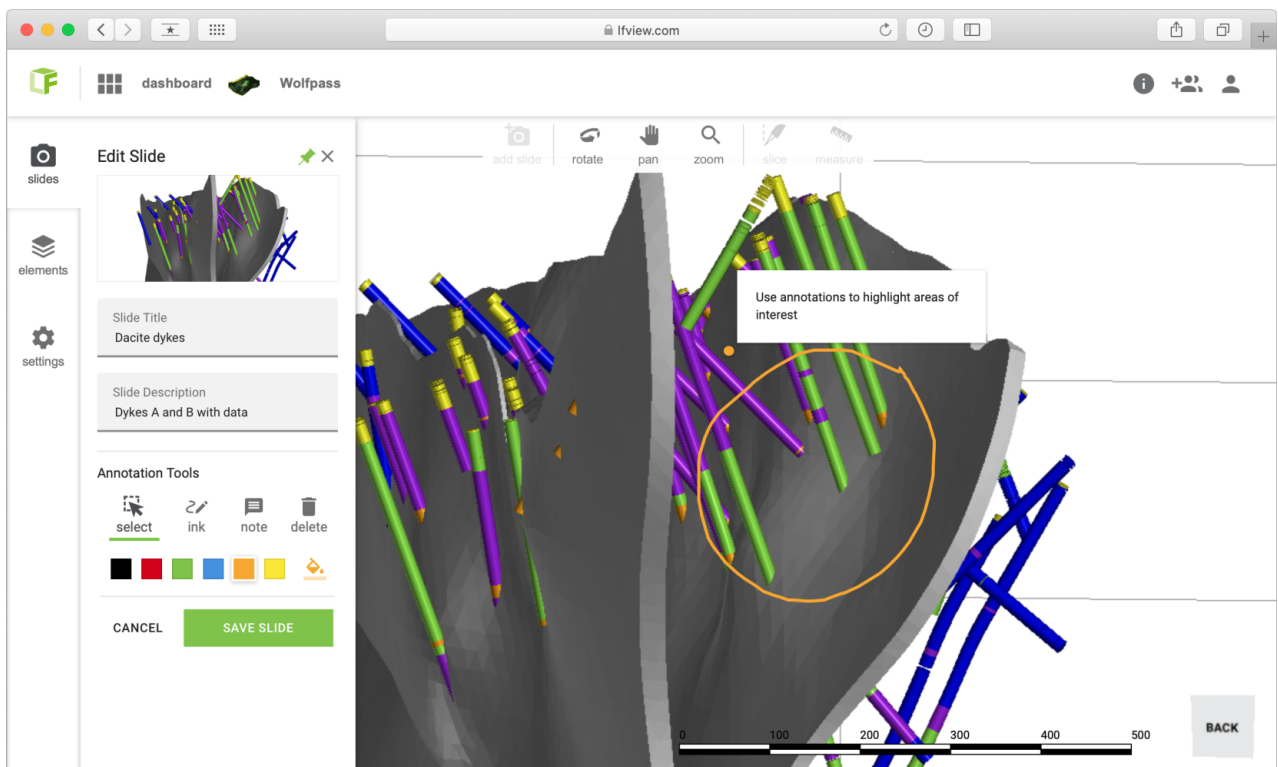

To learn more about using View, visit lfview.com, where you can explore the View gallery and see what's possible:

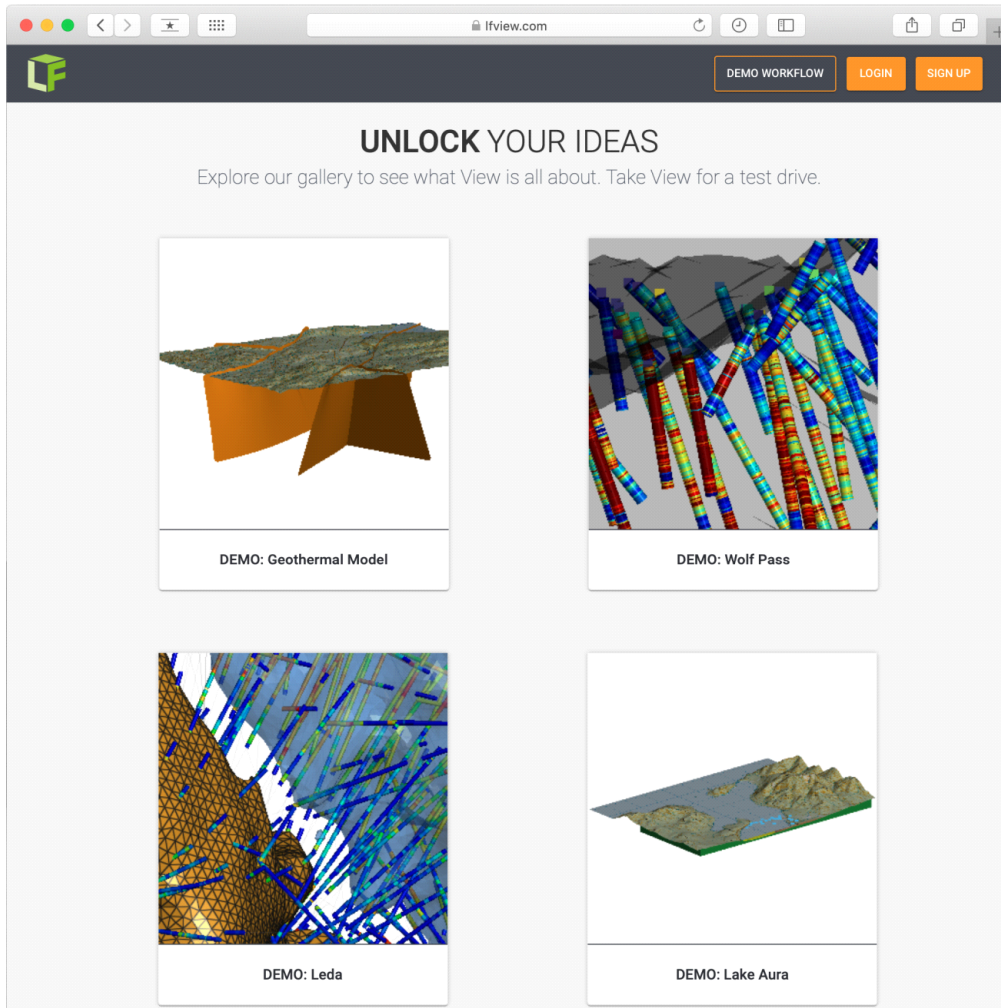

The rest of this topic describes:

- [Signing in to View](#)
- [Uploading to View](#)
- [Troubleshooting Connectivity Issues](#)

Signing in to View

Signing in to My Leapfrog via the **User Identity** menu also signs you in to View.

To enable uploading to View, click on the **Leapfrog Geo** menu and then on **Settings > User Interface**. Tick the box for **Show View upload**. The **View** button () will be displayed in the **Scene View** toolbar.

Uploading to View

There are two options for uploading to View:

- Uploading the current 3D view
- Uploading saved scenes

When selecting the data you will upload to View, think about the slides you wish to make in View.

Uploading the 3D View

The first option for uploading to View is to upload some or all of the objects in the 3D scene. To do this, click the **View** button (📁) in the toolbar:

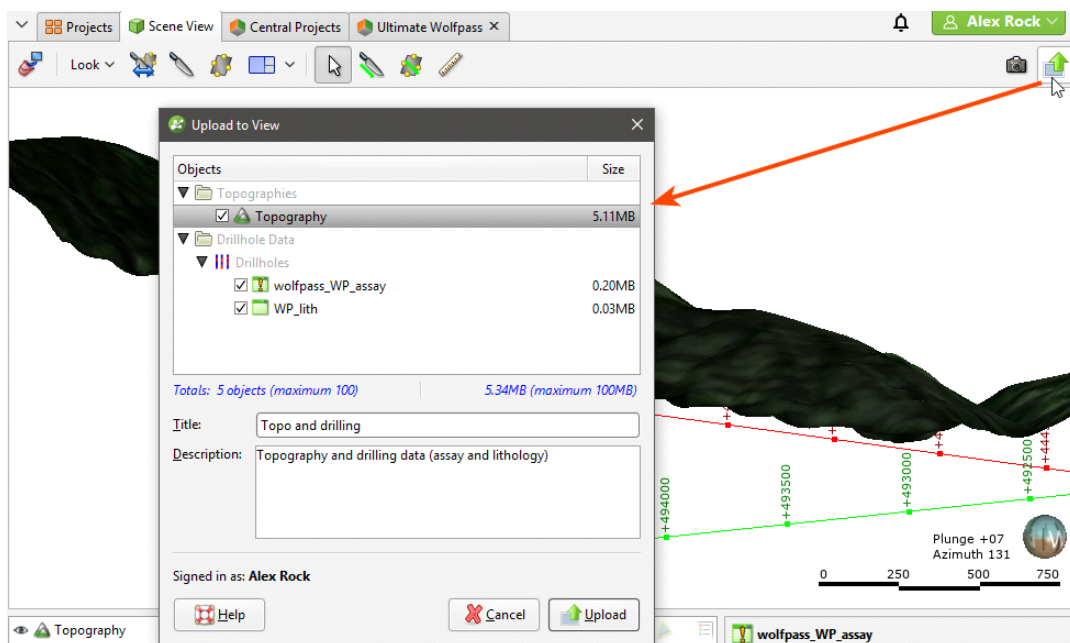

A list of the objects currently in the scene is displayed, along with information about the upload size for each object. Objects that are visible in the scene will automatically be selected, whereas any hidden objects will appear in the list but will not be selected.

If an object in the scene does not appear in the list, it is because the upload of that type of object to View is not supported at this time.

The maximum number of objects and the maximum amount of data that can be uploaded are displayed in the window, so if your scene contains large objects or too many objects, you can select which ones you wish to upload.

When uploading category data columns to View, there is a limit to how many unique codes can be uploaded. If your category data is displaying more than 250 unique codes, consider simplifying your data before uploading to View.

Once you have chosen which objects you want to upload and entered information about the view, click the **Upload** button.

Upload progress is shown in the notifications menu:

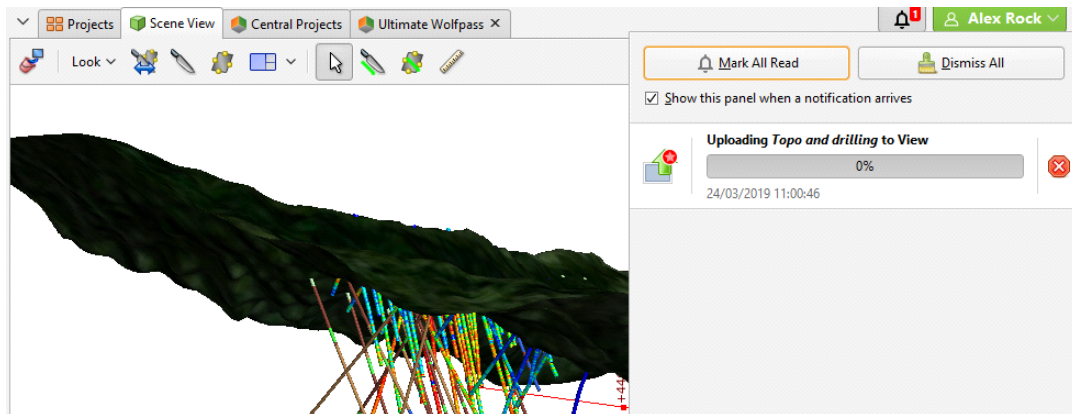

When the upload is complete, a link to View will be displayed in the notification list:

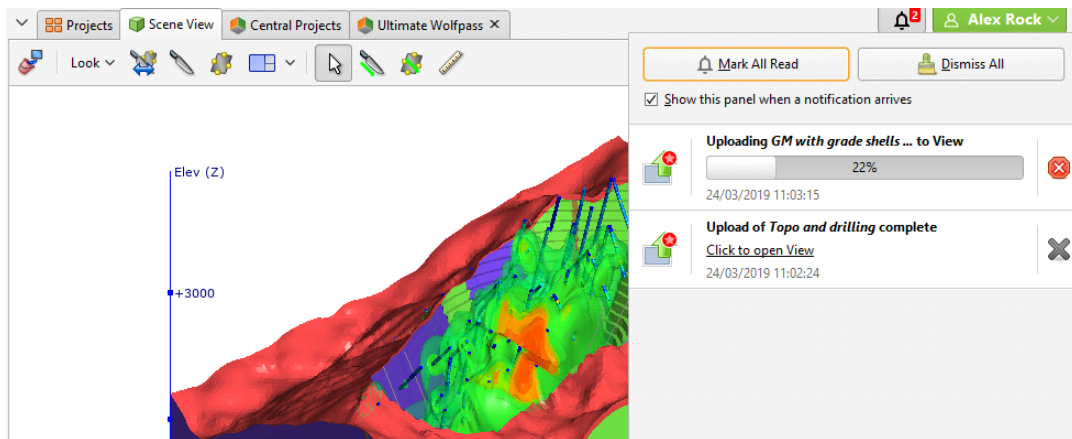

Notifications persist for the duration of your Leapfrog Geo session; all notifications are cleared when you exit Leapfrog Geo.

Uploading Saved Scenes

To upload one of the scenes in the **Saved Scenes and Movies** folder, right-click on the scene and select **Upload to View**. The process is the same as described in [Uploading the 3D View](#) above.

Troubleshooting Connectivity Issues

Leapfrog Start checks to see if your network will support the connection of Leapfrog web-based services to your desktop applications. If you are having trouble with your connection to View, see [Checking Connectivity with Leapfrog Start](#).

Sections

There are three types of sections in Leapfrog Geo:

- A typical cross section is a vertical plane with an image or geologic cross section applied to it. In Leapfrog Geo, this type of cross section can be created directly in the scene, from the slicer or from an imported image.
- A fence section deviates. In Leapfrog Geo, a fence section can be created from a polyline drawn in the scene or from any line object in the project.
- A serial section is a series of typical cross sections taken at an offset from a single base section.

Evaluating on Sections

Different objects in the project can be evaluated on sections, as described in Evaluations. Such objects include:

- Geological models
- Numeric models
- Distance functions
- Surfaces
- GIS lines
- Polylines
- Combined models

When evaluating objects on sections, you can limit the evaluation to the section extents. To do this, enable the **Clip evaluations to section extents** option when selecting what objects you are evaluating.

Block models can be evaluated on cross sections but not on serial sections and fence sections. Objects evaluated on sections can be included when the section is exported.

Exporting Sections

Sections can be exported in the following formats:

- DXF Files (11/12 [AC1009]) (*.dxf)
- Drawing Files (2013/LT2013) (*.dwg)
- Bentley Drawing Files (v8) (*.dgn)

Exporting a section as a DXF file (*.dxf) exports a series of DXF lines created from the intersection of the evaluation volumes and the section plane. The lines generated from each volume are saved as separate layers in the file.

For serial sections, the section will be exported in a single file with a collection of DXF lines based on intersections between the selected evaluation and the section planes.

To export a section in one of these formats, right-click on the section in the project tree and select **Export**. In the window that appears, select the evaluations you wish to export with the section:

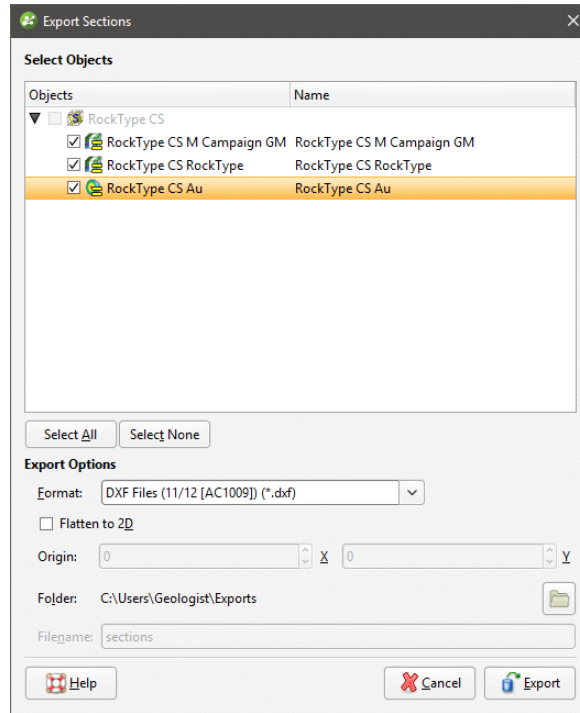

When you enable the **Flatten to 2D** option, the section will be flattened into the X-Y plane, making Z uniform across the section. You can change the origin, if required. The **Flatten to 2D** export option is available for:

- Regular cross sections
- Cross sections created from images
- Child sections of serial and alignment sections

Enter a filename and location, then click **Save**.

Exporting Section Layouts

Another way to export a section is to create a section layout and then export it as a PDF file (*.pdf), Scalable Vector Graphics file (*.svg), PNG image (*.png) or GeoTIFF (*.tiff, *.tif). This option is more flexible than exporting the section as a DXF file as you have more control over the section layout. You can customise the page layout and include multiple evaluations and annotations. For typical cross sections and serial sections, you can also display drillholes and planned drillholes. See the [Section Layouts](#) topic for information in using the section editor.

Once you have finished adjusting the section layout, you can export it in one of the following formats:

- PDF Files (*.pdf)
- Scalable Vector Graphics Files (*.svg)
- PNG Image Files (*.png)
- GeoTIFF Files (*.tiff, *.tif)

Click the **Save and Export** button (📄) at the top of the window. You will be prompted for a filename and location.

For serial sections, you can batch export multiple section layouts. All selected sections can be exported as a single PDF or individually in PDF file (*.pdf), Scalable Vector Graphics file (*.svg), PNG image (*.png) or GeoTIFF (*.tiff, *.tif) formats. When section layouts are exported individually, all outputs can be combined into a zip archive. To do this, right-click on the **Cross Sections and Contours** folder and select **Batch Export Layouts**.

In the window that appears, selection the layouts you wish to export, then select a format. If you select a format other than Single PDF, you can combine all outputs into a zip archive. Select where you wish to save the outputs, then click **Export**. Progress will be displayed at the top of the **Batch Export Section Layouts** window:

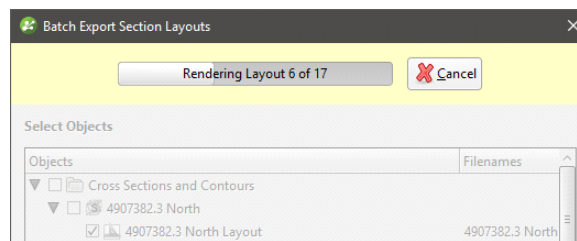

Creating Cross Sections

To create a cross section in the scene, add a model to the scene. Next, right-click on the **Cross Sections and Contours** folder and select **New Cross Section**. The **New Cross Section** window will appear, together with a section plane and controls in the scene that let you adjust the position of the section plane:

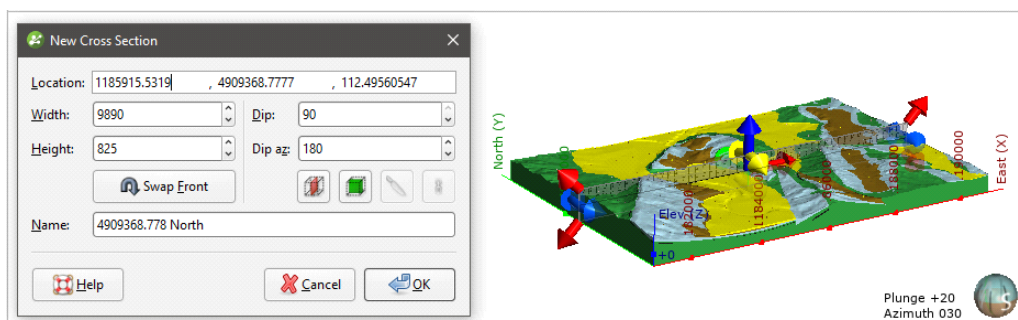

If the slicer is already in the scene when you select **New Cross Section**, the position of the slicer will be used to define the initial orientation of the section. This is an effective way of

creating a section from the slicer: add the model to the scene, draw a slice and then create a cross section.

The front (F) and back (B) of the section plane is indicated in the scene. To swap the front and back, click the **Swap Front** button (🔄).

Use the handles in the scene to position the section plane. The handles work in the same manner as the moving plane controls, as described in [The Moving Plane](#).

Two buttons in the **New Cross Section** window let you create a cross section that is aligned north-to-south (📍) or east-to-west (📍):

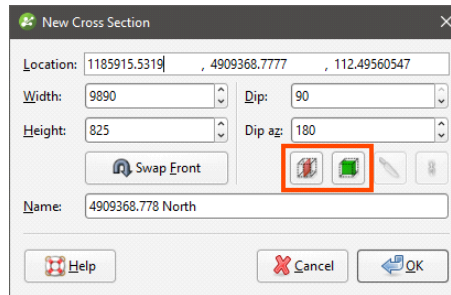

The other two buttons are active when the slicer is in the scene. Clicking the **Set section to slicer** button (📍) creates a cross section from the position of the slicer in the scene. When the **Lock section to slicer** button (🔒) is enabled, moving the position of the slicer will update the position of the cross section in the **New Cross Section** window.

Once the section plane is positioned as required, click **OK** to create the new cross section, which will appear in the **Cross Sections and Contours** folder. Display it by clearing the scene, then adding the cross section to the scene.

Many objects in a project can be evaluated on cross sections, as described in [Evaluations](#). Such objects include:

- Geological models
- Interpolants
- Distance functions
- Surfaces
- GIS lines
- Polylines

Objects evaluated on a cross section or fence section can be included when the section is exported.

Importing Cross Sections

To import an image and use it to create a new cross section, right-click on the **Cross Sections and Contours** folder and select **New Cross Section From Image**. Leapfrog Geo supports the following file formats for creating cross sections:

- PNG files (*.png)
- JPEG files (*.jpg, *.jpeg)
- TIFF and GeoTIFF files (*.tiff, *.tif)
- Windows Bitmap files (*.bmp)
- Graphics Interchange Format files (*.gif)

Select an image, then click **Open**. The **Import Section Image** window will be displayed.

Cropping the image to only the area of interest will reduce video RAM usage and may improve graphics performance. To crop the image, click on the **Crop Image** button (📏) at the top of the window, then drag around the part of the image you wish to use. Click on the **Remove Crop** button (🗑️) to clear the cropping.

If the image is georeferenced and you are satisfied that this information is correct, click **Import**. The new cross section will be created and added to the **Cross Sections and Contours** folder.

If the image does not contain georeferencing information, you will need to add it manually by adding reference markers and then entering coordinates. First, tick the box for any **Section Type** options as these constrain the markers that need to be set. For example, selecting **East facing section** means you will only need to enter the **East (X)** coordinates once.

To add coordinates to the image, click on a marker and move it to the required location. Then enter the coordinates for the marker:

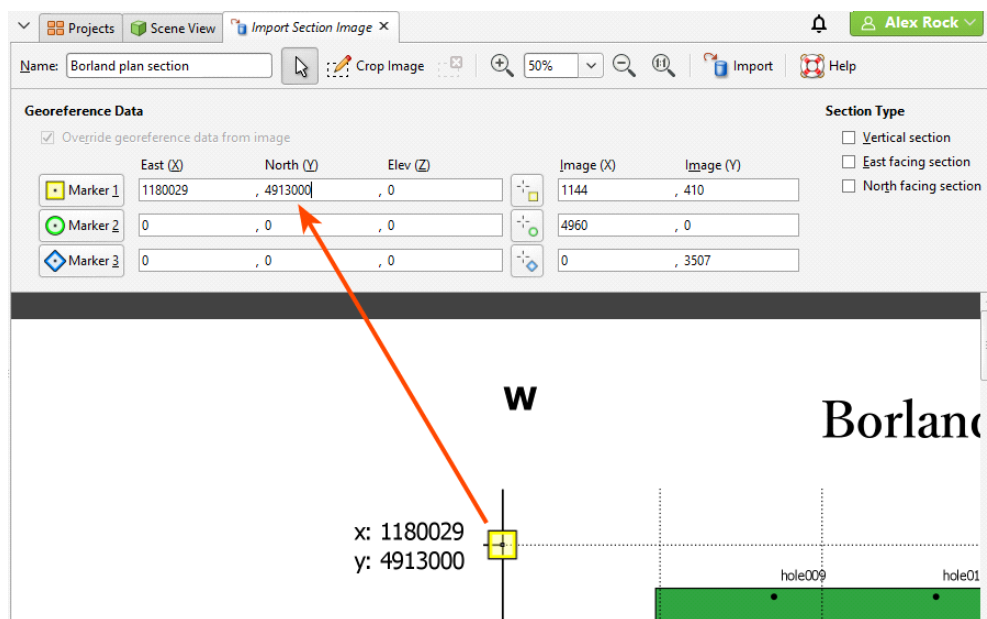

The **Image (X)** and **Image (Y)** fields give you fine control over the location of the marker on the image.

If the image is georeferenced and you wish to discard the information, tick the **Override georeference data from image** box and edit the markers.

Once the coordinates for each marker have been set, click **Import**. The new cross section will be created and added to the **Cross Sections and Contours** folder. Display it by dragging it into the scene or by right-clicking on the cross section and selecting **View Object**.

Once you have georeferenced an image, you can export it as a GeoTIFF. To do this, right-click on it in the project tree and select **Export**. You will be prompted for a filename and location. Click **Save**.

Once you have created a cross section, you can edit it or use it to evaluate geological models, interpolants, distance functions and surfaces. See [Evaluations](#).

Fence Sections

You can draw a polyline or use any existing line object in the project to create a cross section that deviates. To do this, right-click on the **Cross Sections and Contours** folder and select **New Fence Section**. The **New Fence Section** window will be displayed:

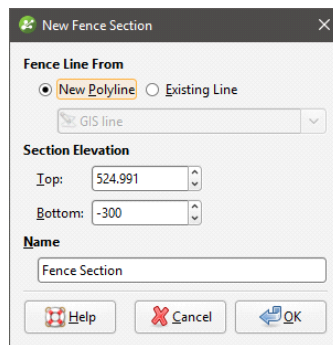

You can draw the polyline in the scene directly by selecting the **New Polyline** option. You can also use any polyline in the project by selecting the **Existing Polyline** option.

Only GIS lines, polylines imported into Leapfrog Geo or polylines created using the straight line drawing tool can be used to create fence sections.

Click **OK** to create the fence section. If you chose to create a **New Polyline**, the drawing controls will appear in the scene and you can begin drawing, as described in [Drawing in the Scene](#).

The fence section will appear under the **Cross Sections and Contours** folder and you can edit it by double-clicking on it. You can also use it to evaluate different objects in the project, as described in [Evaluations](#). Such objects include:

- Geological models
- Interpolants
- Distance functions
- Surfaces

- GIS lines
- Polylines

If you create a section layout for a fence section, you can include multiple evaluations and annotations on the section layout. See [Section Layouts](#).

Serial Sections

This topic describes the process of creating a serial section, which is a series of cross sections taken at an offset from a single base section. The topic is divided into:

- [Setting the Base Section](#)
- [Setting the Offset Sections](#)
- [The Serial Section in the Project Tree](#)
- [Displaying a Serial Section](#)
- [Exporting a Serial Section](#)

To create a serial section, add a model to the scene. Next, right-click on the **Cross Sections and Contours** folder and select **New Serial Section**. The **New Serial Section** window will appear and planes representing the base section and the offset sections will be added to the scene:

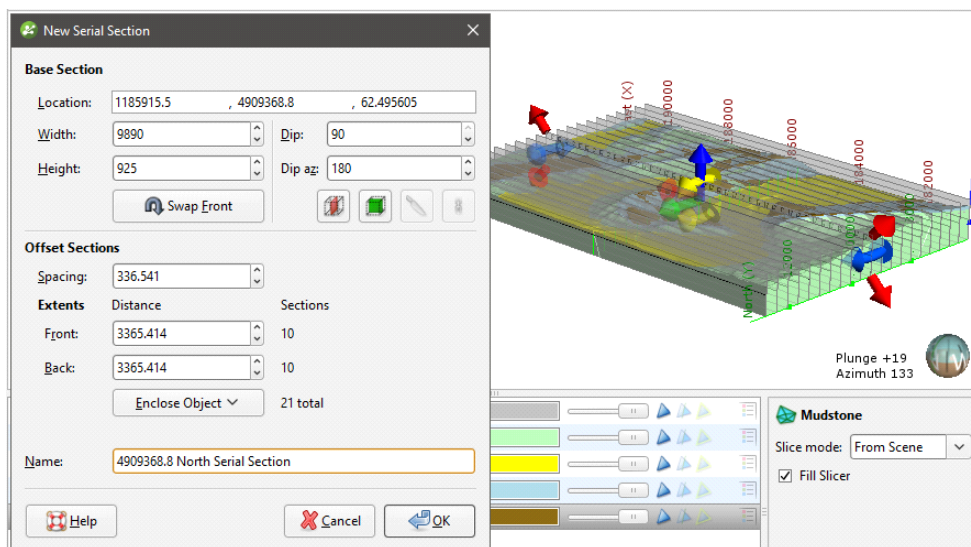

If the slicer is already in the scene when you select **New Serial Section**, the position of the slicer will be used to define the initial orientation of the base section.

Setting the Base Section

The handles in the scene control the position of the base section and work in the same manner as the moving plane controls (see [The Moving Plane](#)).

The front (F) and back (B) of the base section plane are indicated in the scene. To swap the front and back, click the **Swap Front** button (🔄).

Two buttons in the **New Serial Section** window let you create a base section that is aligned north-to-south (📍) or east-to-west (📍). The other two buttons are active when the slicer is in the scene. Clicking the **Set section to slicer** button (📍) creates a cross section from the position of the slicer in the scene. When the **Lock section to slicer** button (🔒) is enabled, moving the position of the slicer will update the position of the cross section in the **New Serial Section** window.

Setting the Offset Sections

The number of offset sections is determined by the value of the **Spacing** setting and the **Front** and **Back Extents**:

The screenshot shows the 'New Serial Section' dialog box with the following settings:

- Base Section:**
 - Location: 1185915.5, 4909368.8, 62.495605
 - Width: 9890
 - Height: 925
 - Dip: 90
 - Dip az: 180
- Offset Sections (highlighted):**
 - Spacing: 336.541
 - Front: 3365.414 (10 sections)
 - Back: 3365.414 (10 sections)
 - Enclose Object: 21 total
- Name:** 4909368.8 North Serial Section

You can change the number of offset sections by:

- Changing the **Spacing** setting. The number of offset sections will be recalculated and updated in the scene.
- Changing the **Front** or **Back** settings. For example, increasing the **Front** setting adds an offset section on the front of the base section, increasing the extents by the value of **Spacing**.
- Changing the object used to define the extents. Select an object from the **Enclose Object** list. The base section will be moved to the centre of the selected object.

The Serial Section in the Project Tree

Click **OK** to create the section. In the project tree, the serial section includes the individual cross sections:

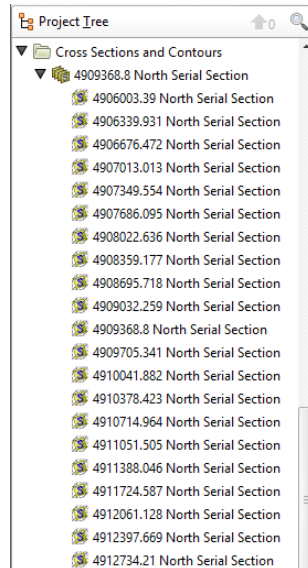

Many objects in a project can be evaluated on serial sections, as described in [Evaluations](#). Such objects include:

- Geological models
- Interpolants
- Distance functions
- Surfaces
- GIS lines
- Polylines

Displaying a Serial Section

When you display a serial section in the scene, you can add the slicer to the scene and use it to move easily between the sections in the stack. To do this, click on the slicer in the shape list, then select the base section from the **Set to** list:

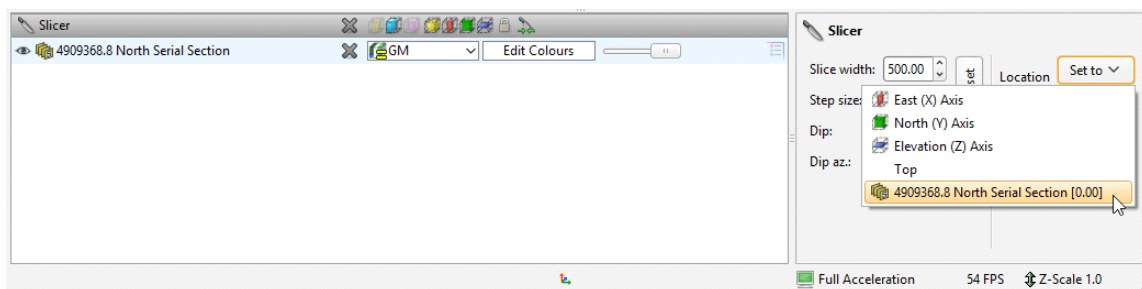

Next, set the **Step size** to the **Spacing** setting used to create the section. You can then use the < and > keys to view each individual cross section.

Exporting a Serial Section

The options for exporting serial sections differ for the section itself and the offset sections:

- A serial section cannot be used to create a section layout. When exported as a DXF file, the serial section will be exported in a single file with a collection of DXF lines based on intersections between the selected evaluation and the section planes.
- The offset sections that make up a serial section can be exported in DXF format or as a section layout. See [Exporting Sections](#) and [Section Layouts](#) for more information.

Section Layouts

With the **Section Layout Editor**, you can create a section layout for an existing section and then export the section. You can customise the section layout by:

- Adding models, surfaces and lines the section has been evaluated against
- Adding drillholes and planned drillholes
- Changing the page size, orientation and margins
- Adding titles, a scale bar, legends, annotations and images, such as a standard form or logo

The appearance of all objects can be customised without changing how objects from the project tree are displayed in the scene.

Section layouts can be displayed in the scene by dragging a layout into the scene:

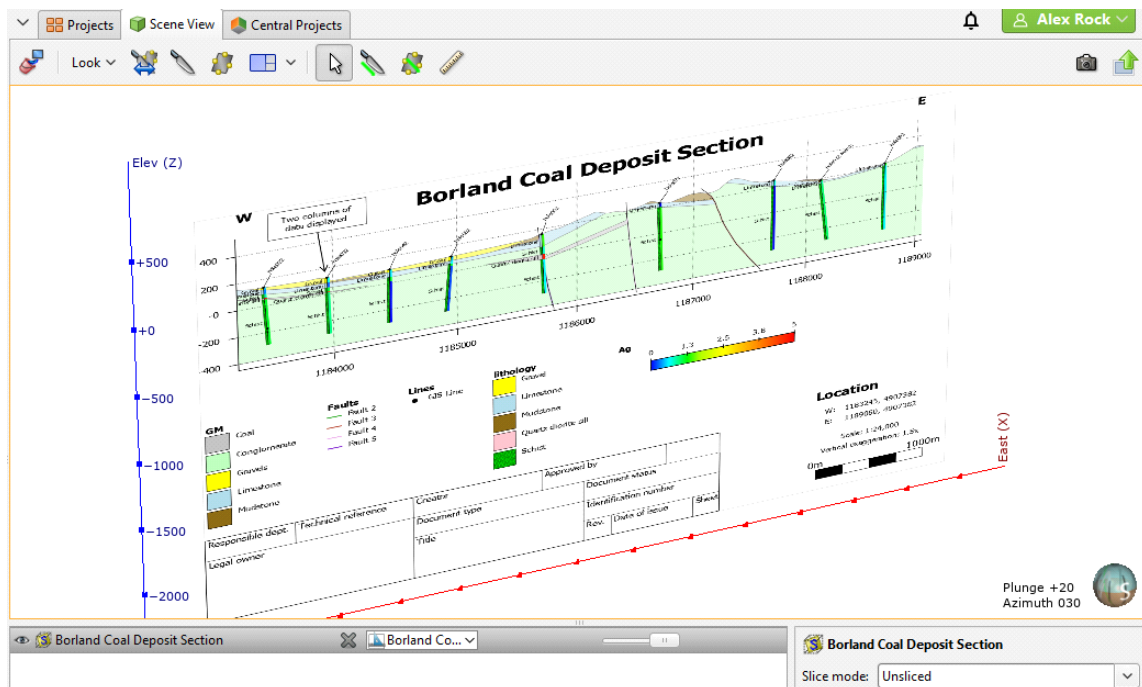

Some sections will be too large to display in the scene, which will be indicated in the section layout editor.

Displaying section layouts in the scene is useful when you are editing a section layout and wish to see the effect of changes. Detach the section layout tab from the main window and position it adjacent to the scene window. Periodically save your changes to the section layout to see the effects of those changes in the scene.

This topic describes how to work with section layouts. It is divided into:

- [Setting Up the Section](#)
- [Creating New Section Layouts](#)
- [Copying Section Layouts](#)

- [Working With the Section Layout Editor](#)
- [Changing Page Properties](#)
- [Changing the Basic Section Properties](#)
- [Organising Objects on the Section](#)
- [Setting Up the Legend](#)
- [Adding and Organising Annotations](#)

Setting Up the Section

Once you have created a section but before you start creating the section layout, take the following steps.

1. Check the section’s extents and orientation.

The initial dimensions of the section on the page are determined by the size of the section plane, and its orientation on the page is determined by the front (F) and back (B) faces of the section plane. Here, the front and back faces of the section have been swapped, which results in the section displayed on the page being flipped:

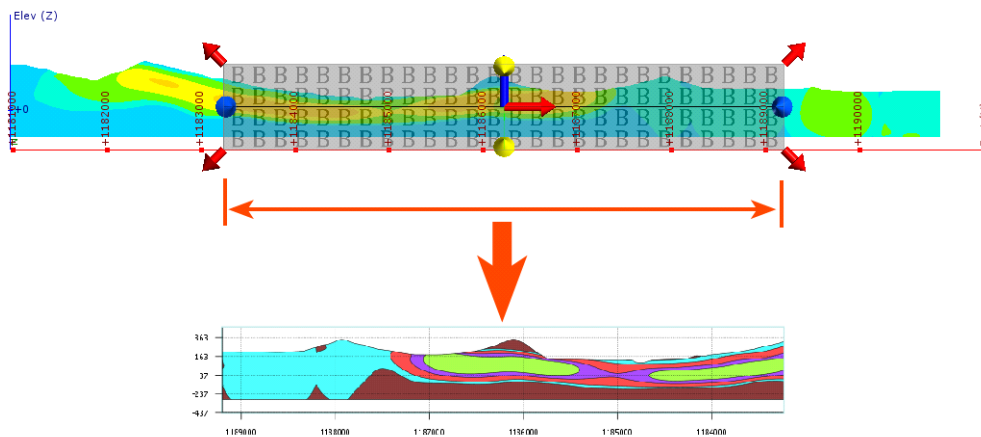

2. Check that the section has been evaluated against objects you wish to display on the page. To do this, right-click on the section in the project tree and select **Evaluations** or **Evaluate Surface**.

3. Add planned drillholes to the project.

Planned drillholes can be displayed on the section, but these must be defined before you start the process of laying out the section.

Creating New Section Layouts

To create a new section layout, right-click on an existing section in the project tree and select **New Section Layout**. The **New Section Layout** window will appear, together with the **Section Layout Editor**:

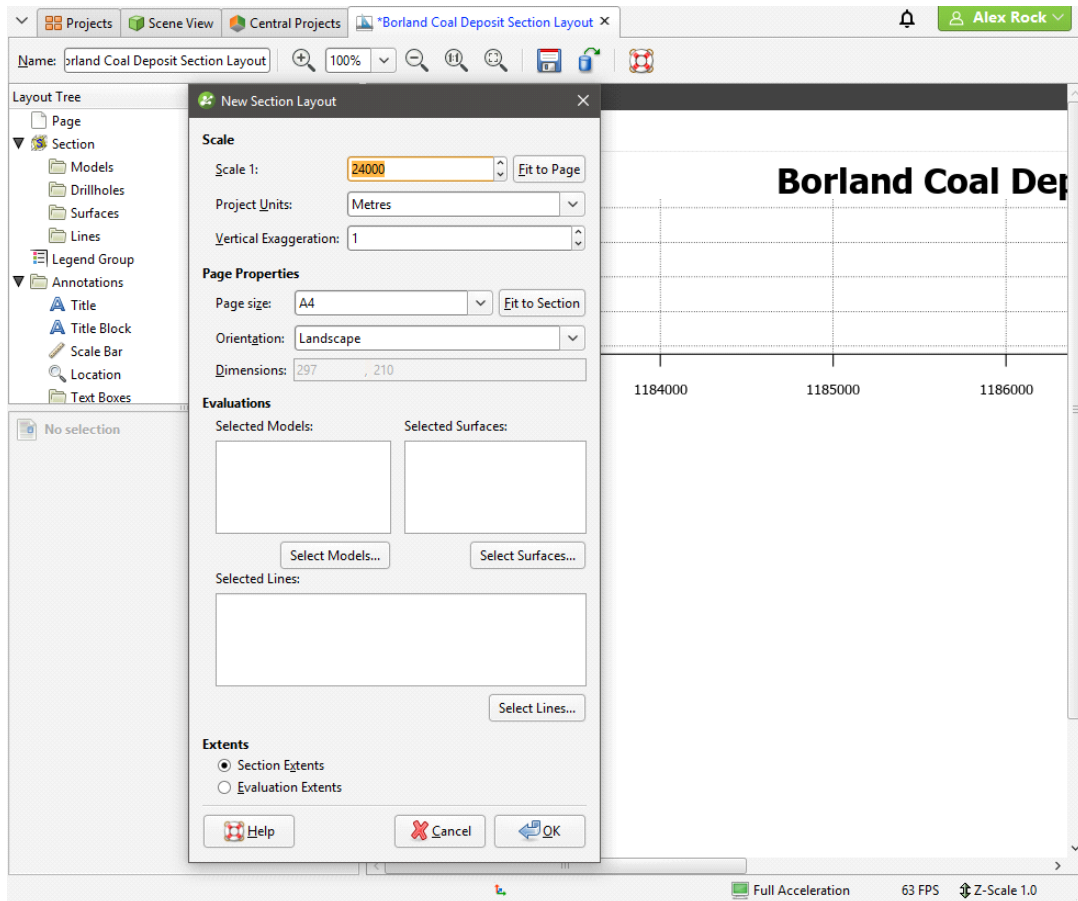

The settings in the **New Section Layout** window determine the basic section layout:

- The **Scale** settings determine the scale used to display the section on the page. If you want a specific page size, select **Fit to Page** to set a scale that best fits the page width. You will be able to change the page margins once you have closed the **New Section Layout** window.
- The **Page Properties** settings determine the page size and orientation. If you wish to use a specific **Scale**, select the **Orientation** required, then click **Fit to Section** to choose the best page size.
- For **Evaluations**, select from the models, surfaces and lines the section has been evaluated against. When you select an evaluation, it will be added to the preview.
- For **Extents**, choose whether to use the **Section Extents** or **Evaluation Extents**. If you wish to use the extents from a model evaluation, add only that model to the **Models**, **Surfaces** or **Lines** list, then select the **Evaluation Extents** option. Once you have closed this window, you will be able to add further models, surfaces and lines using the section layout editor.

As you change settings and add objects to the section, the preview in the **Section Layout Editor** window will be updated. All settings in the **New Section Layout** window can be changed once the layout has been created.

Click **OK** to close the **New Section Layout** window. You can then make further changes to the page layout in the **Section Layout Editor**. See [Working With the Section Layout Editor](#).

Copying Section Layouts

If you have already created a section layout and wish to reuse it, you can copy it to other sections.

Copying a section layout copies the evaluations used in the original section layout, together with the page size and orientation and the position of the **Layout Tree** objects on the page. How models, surfaces and drillholes are copied depends on the section to which the layout is being copied:

- All models and surfaces that can be displayed on the section will be copied.
- The drillholes copied to the layout will depend on the type of section the layout is being copied from and whether or not a filter is set for the layout:
 - If no distance filter was set for the original layout, all drillholes selected for the original layout will be copied.
 - If a distance filter was applied to the original section, the filter will be applied and drillholes selected that are within that distance of the section to which the layout is being copied.
 - When the original layout is from a fence section, drillhole evaluations will not be copied with the section layout.

To copy a layout, right-click on the layout you wish to copy and select **Copy Layout To**. In the window that appears, a summary of the information that will be copied is displayed so you can see what information will be copied to the selected sections. Move the sections you wish to copy the layout to into the **Selected Sections** list, then click **OK**. A copy of the layout will appear in the project tree under each section you selected. The layout copies are not linked to the original layout and so will not be updated when the original is updated.

Copying section layouts to multiple sections can result in numerous section layouts in a project, which can be difficult to work with. The recommended workflow for creating a section layout that you intend to make multiple copies of is to first get the layout right on one section before copying it to other sections.

Working With the Section Layout Editor

In **Section Layout Editor**, the **Layout Tree** shows the different layers that can be added to the page. The different parts of the **Layout Tree** as they relate to the page preview are shown below:

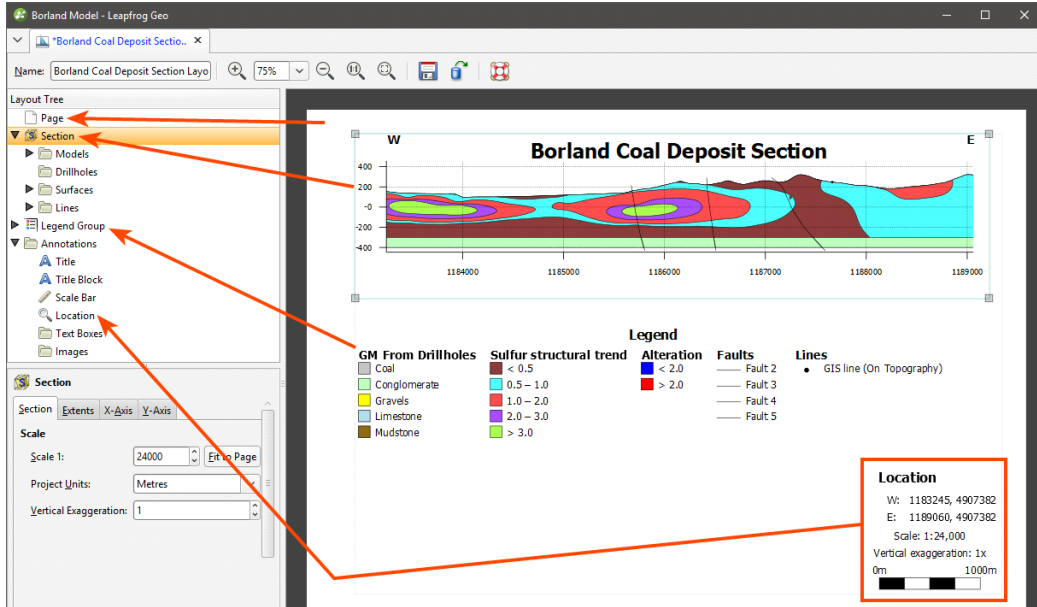

When you select an object in the layout tree, it will be highlighted by a blue line on the page. In the example above, the **Section** object is selected.

Click on an object in the page preview to move or resize it. This will also select the object in the **Layout Tree** and you can see what properties can be changed. For example, in the preview, click on the **Title** to view its styling options:

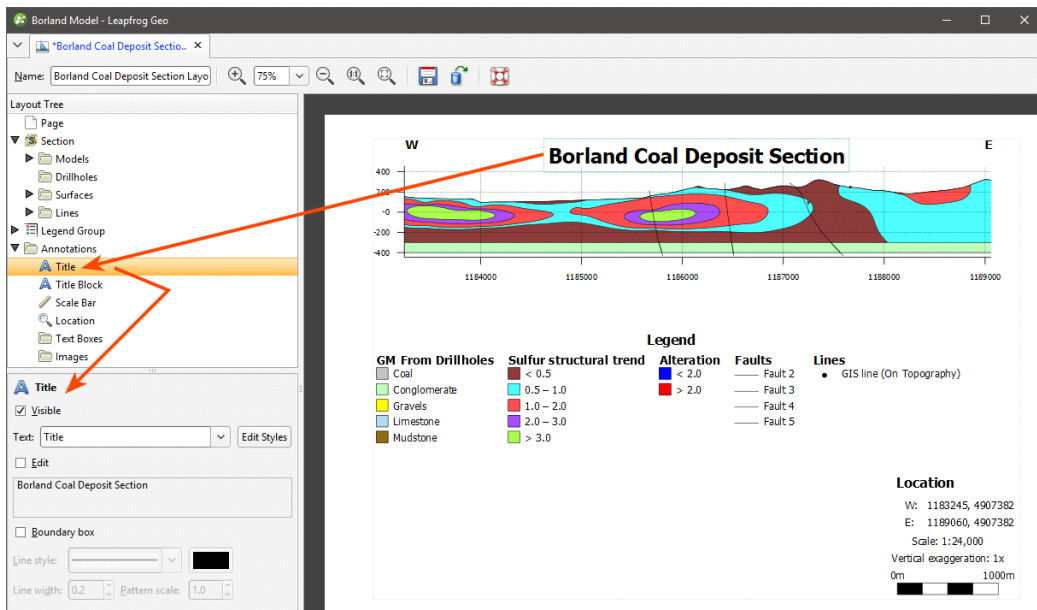

Text displayed in the section layout is controlled by a style sheet that can be accessed whenever you are editing a text object. For example, clicking on **Edit Styles** for the **Title** opens the list of

Text Styles with the **Title** selected, but also allows you to change the appearance of styles used for other text objects visible in the preview:

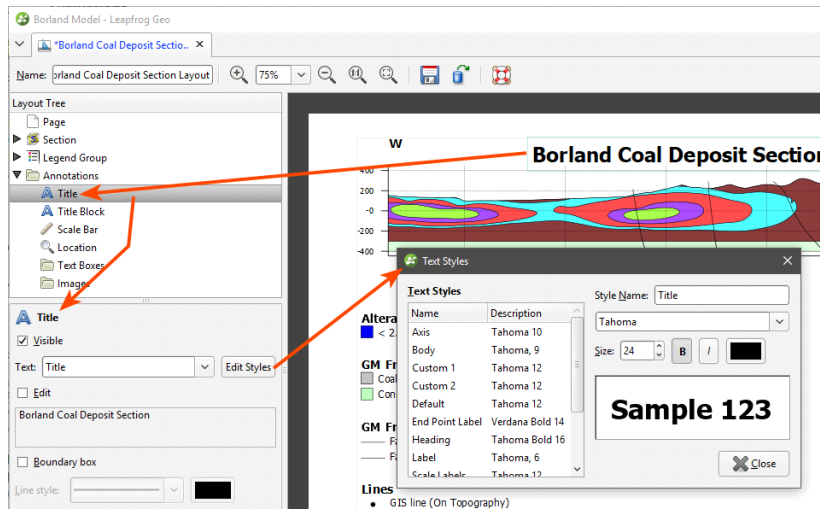

Changing Page Properties

In the **Layout Tree**, click on **Page** to change the **Page Size**, **Orientation** and **Margins**:

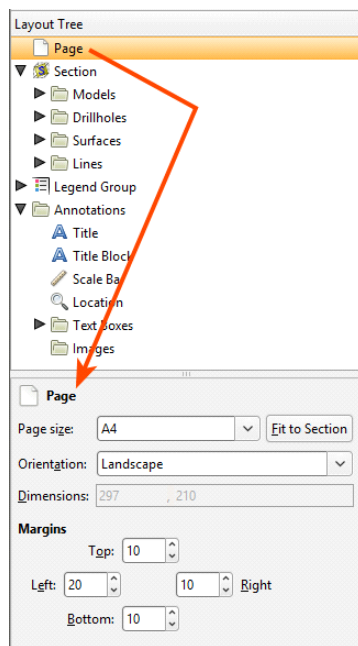

If you wish to use a specific **Scale**, select the **Orientation** required, then click **Fit to Section** to choose the best page size.

Changing the Basic Section Properties

To change the section layout's basic properties, click on the **Section** object in the **Layout Tree**. In the **Section** tab, you can change the scale and units used in the layout and the amount of **Vertical Exaggeration**:

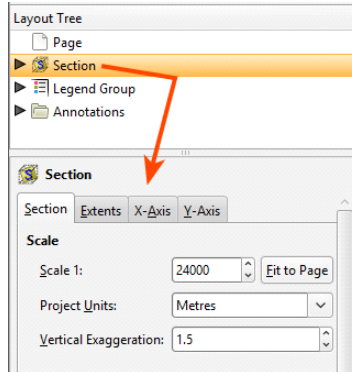

For the **Scale**, you can enter a specific value to use in displaying the section on the page, or, if you want a specific page size, select **Fit to Page** to set a scale that best fits the page width.

If you want to change the page size and the margins used, click on the **Page** object.

To change the size of the section contents (models, drillholes, surfaces and lines) on the page, click on the **Extents** tab:

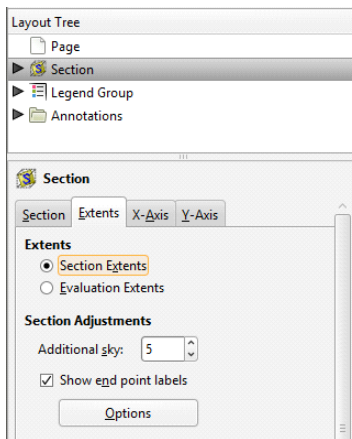

For **Extents**, choose whether to use the **Section Extents** or **Evaluation Extents**.

You may wish to add more space above the section, especially if you will be adding drillholes to the section and need extra space for the collar labels. To do this, change the **Additional sky** setting. These images show the effects of two different **Additional sky** settings:

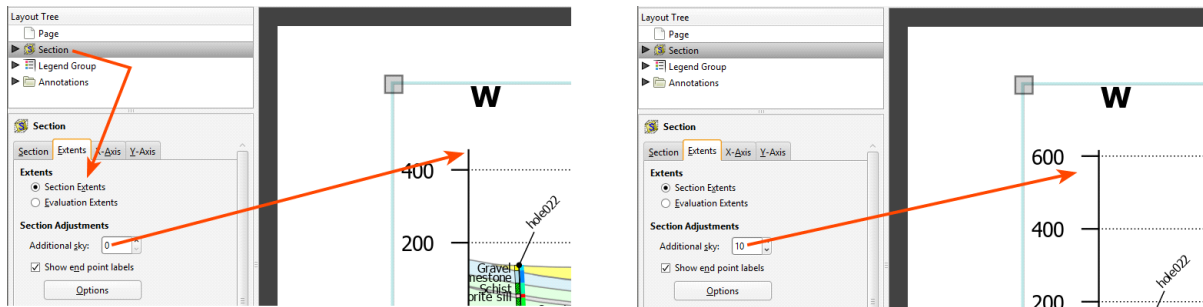

Enable **Show end point labels** to display the section's end points as text:

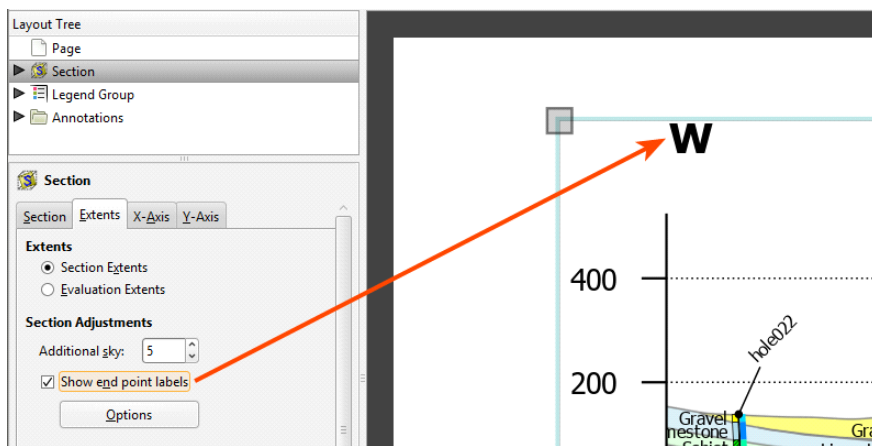

Click **Options** to change how the end points are displayed relative to the section's axes. There are two options that control where the end points are displayed, **Points above** and **Points aligned inside**. The **Points above** setting determines whether the end points are displayed above or beneath the axes. Note here the difference between **Points above** being disabled and enabled:

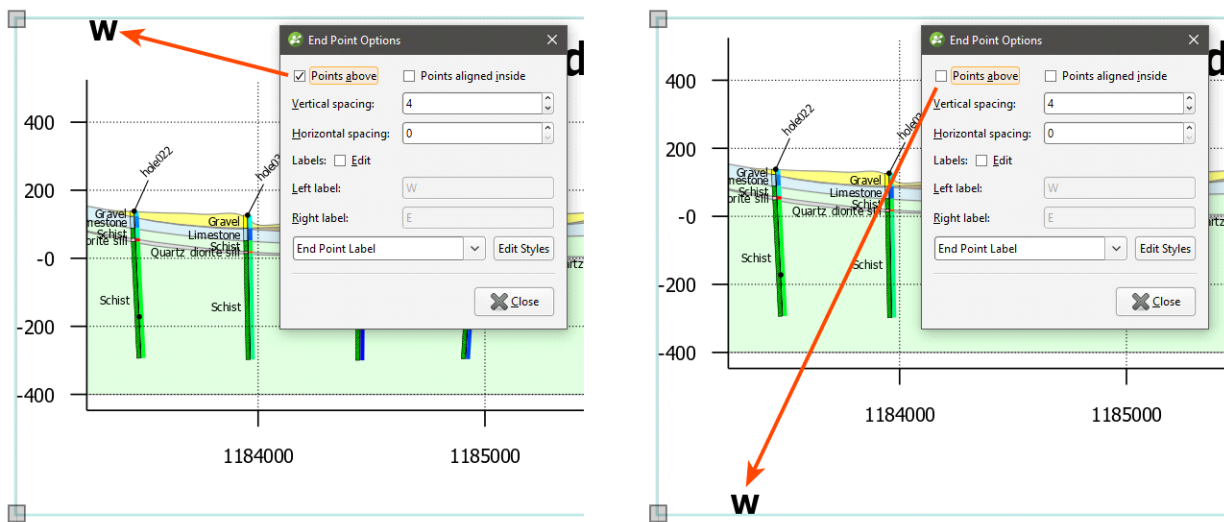

The **Points aligned inside** setting determines whether the end points are displayed inside or outside the section's axes:

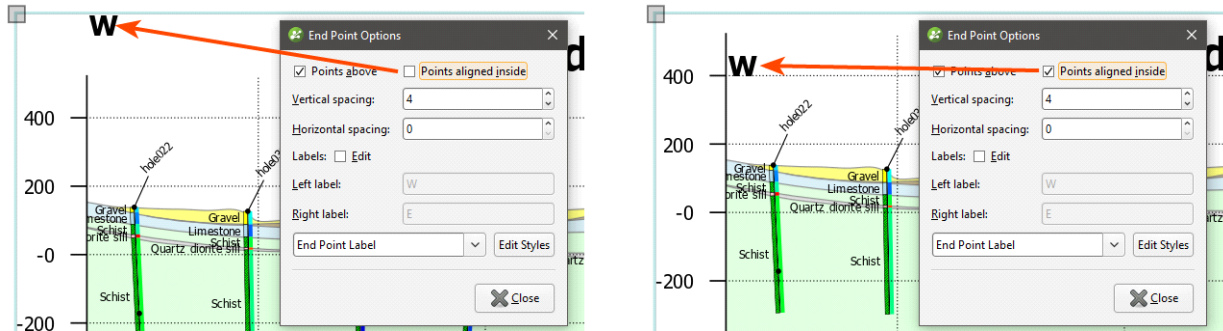

You can also change the spacing between the end point labels and the section axes.

Edit the text used to display the end points by enabling the **Edit** box and then changing the text. You can edit the style used for displaying the labels by clicking **Edit Styles** to change the style or by selecting a different style from the dropdown list.

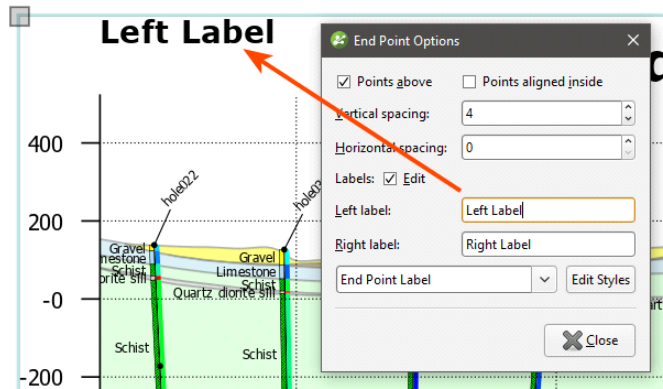

To change how the axes are displayed, click on either the **X-Axis** tab or the **Y-Axis** tab. One of the options available for the axes is how much information is displayed for the **Real World Coordinates** on each axis:

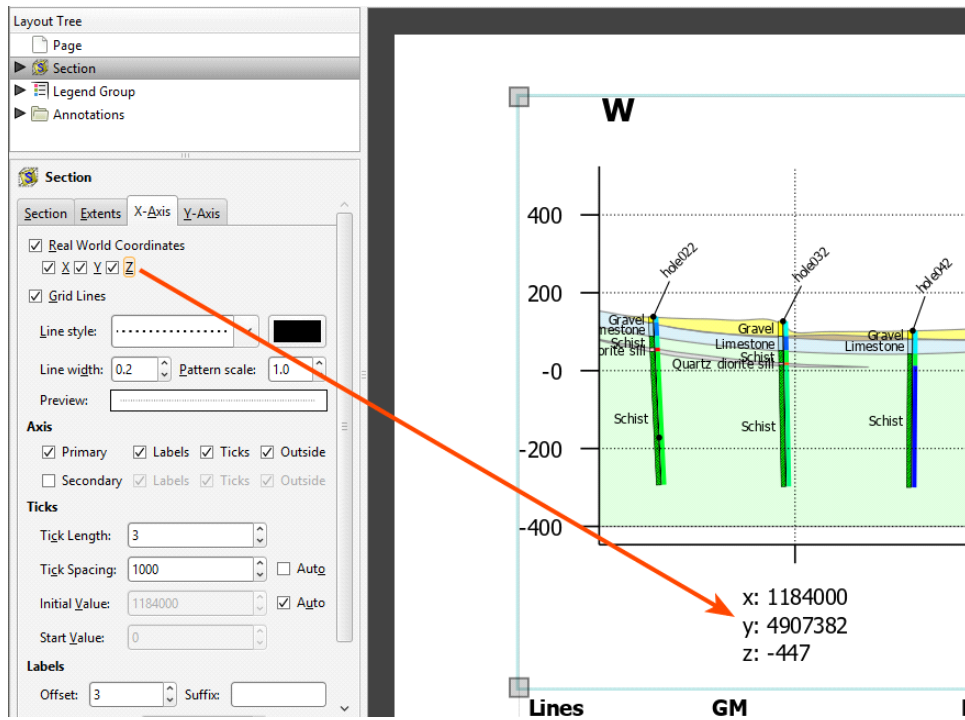

You can also change how **Grid Lines** are displayed, including the **Line style**, **Line width**, **Pattern scale** and colour. A **Preview** is displayed and the grid lines are updated in the section preview.

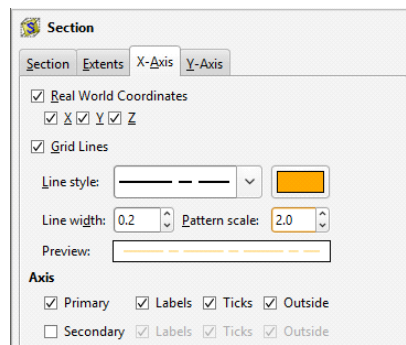

By default, the axes are displayed only on the left-hand side and along the bottom of the section. To display axes along the right-hand side and above the section, tick the **Secondary** option.

For the **Ticks**, Leapfrog Geo automatically calculates an **Initial Value**:

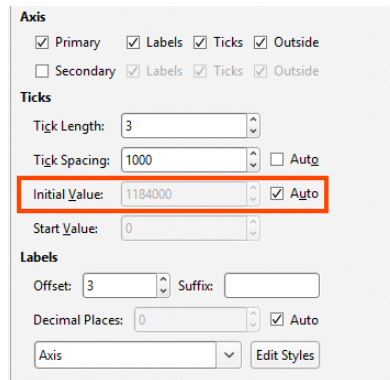

If you wish to change this, disable **Auto** and enter the required value.

If you wish to set an X-axis **Start Value** other than 0, you must first disable the **Real World Coordinates** option:

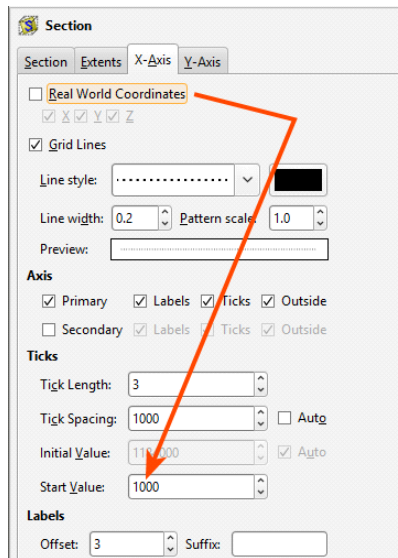

Edit the style used for displaying the axis labels by clicking **Edit Styles** to change the style or by selecting a different style from the dropdown list.

Organising Objects on the Section

The folders below the **Section** object are used to add and organise models, drillholes, surfaces and lines and to customise how they are displayed:

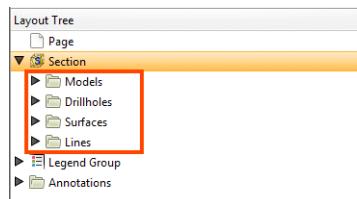

If you selected models, surfaces and lines when you created the section, they will appear in one of these folders. You can add new objects by right-clicking on a folder and selecting an **Add** option:

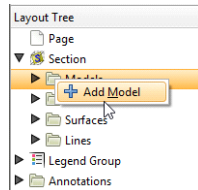

- For the **Add Model**, **Add Surface** and **Add Line** options, you will be able to choose from the objects that have been evaluated on the section. See [Evaluating on Sections](#) for more information.
- For the **Drillholes** folder, there are two options, **Add Drillholes** and **Add Planned Drillholes**. For both options, you can choose from the drillholes and planned drillholes available in the project; it is not necessary to evaluate these onto the section before you can add them to the layout.

Models, drillholes, surfaces and lines occupy the same space on the section layout, and opacity settings and an object’s position among the layers can be used changed to emphasise relevant information. To change the order of objects on the page, right-click on them and select an option:

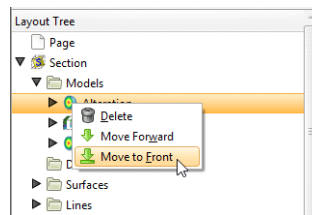

Models will always be among the lower layers, with lines on top of all the other layers.

You can remove objects from the layout by right-clicking on them and selecting **Delete**.

To change the opacity of an object, click on it, then adjust the object’s **Opacity** using the slider:

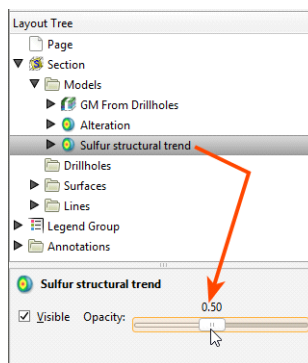

Adding and Styling Models

The **Models** folder contains all models that have been added to the section layout. To add another model, first make sure it has been evaluated on the section, then right-click on the **Models** folder and select **Add Model**. Select from those available and click **OK**.

When you display multiple models on the section, you can end up with a large number of objects that obscure the information you want to emphasise. You can:

- Use the **Opacity** setting for each model to expose and emphasise information.
- Right-click on the models to move them up or down in the layer hierarchy.
- For geological models, numeric models and combined models, expand the model in the **Layout Tree** to change how each output volume is displayed. You can also hide some of the output volumes.
- For flow models and block models, you can hide categories or filter the values used to display the model.

If a geological model with an active fault system is added to the section layout, it will include a **Fault System** that contains all the active faults in the model. Click on the **Fault System** to control whether or not it is **Visible** and to set its **Opacity**:

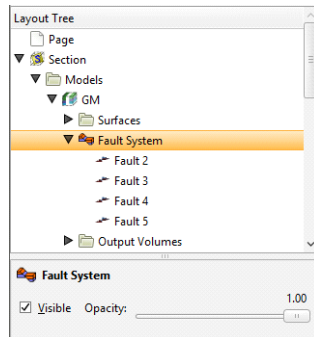

Click on the individual faults to control how they are displayed:

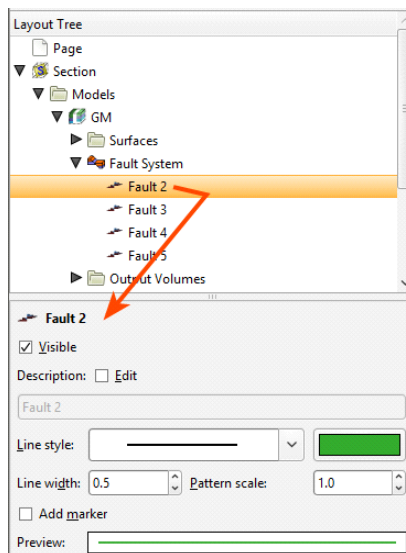

Edit the fault's **Description** by enabling the **Edit** box and then changing the text. You can also change how the fault is displayed, including the **Line style**, **Line width**, **Pattern scale** and colour. You can also define a marker to display along the line by enabling **Add marker** and then specifying a **Symbol** to use. A **Preview** is displayed and the fault will be updated in the section preview:

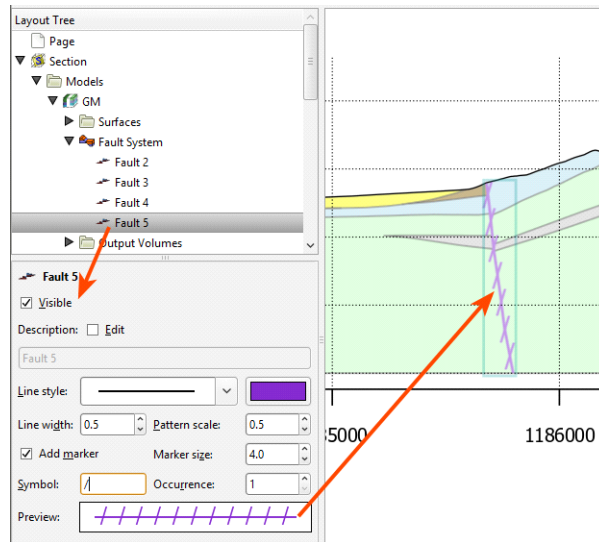

For the volumes in the **Output Volumes** folder, line, border and swatch properties by clicking on the volume in the **Layout Tree** and then changing their properties. Swatches for output volumes can be displayed using a hatched fill. To do this, click on the volume, enable the **Hatch** option and click on the sample to view the available patterns:

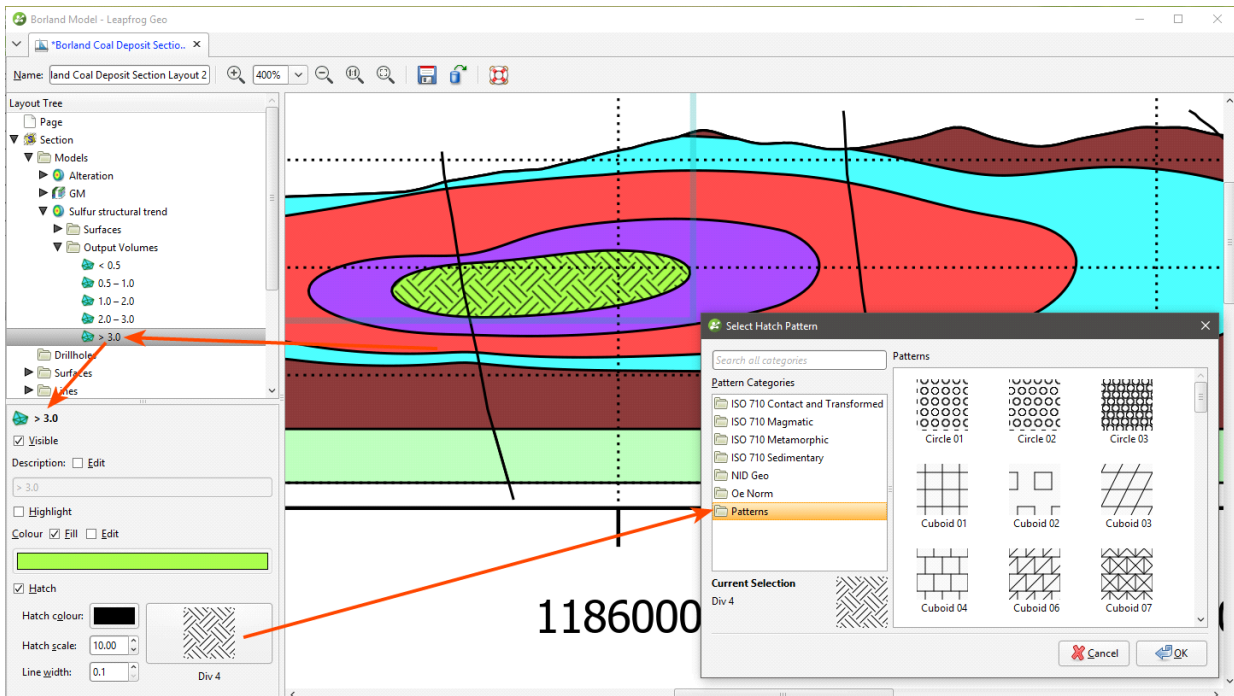

A single line style is used to display a model's output volumes. There is, however, a **Highlight** option that can be enabled to make a volume of interest stand out from the other volumes:

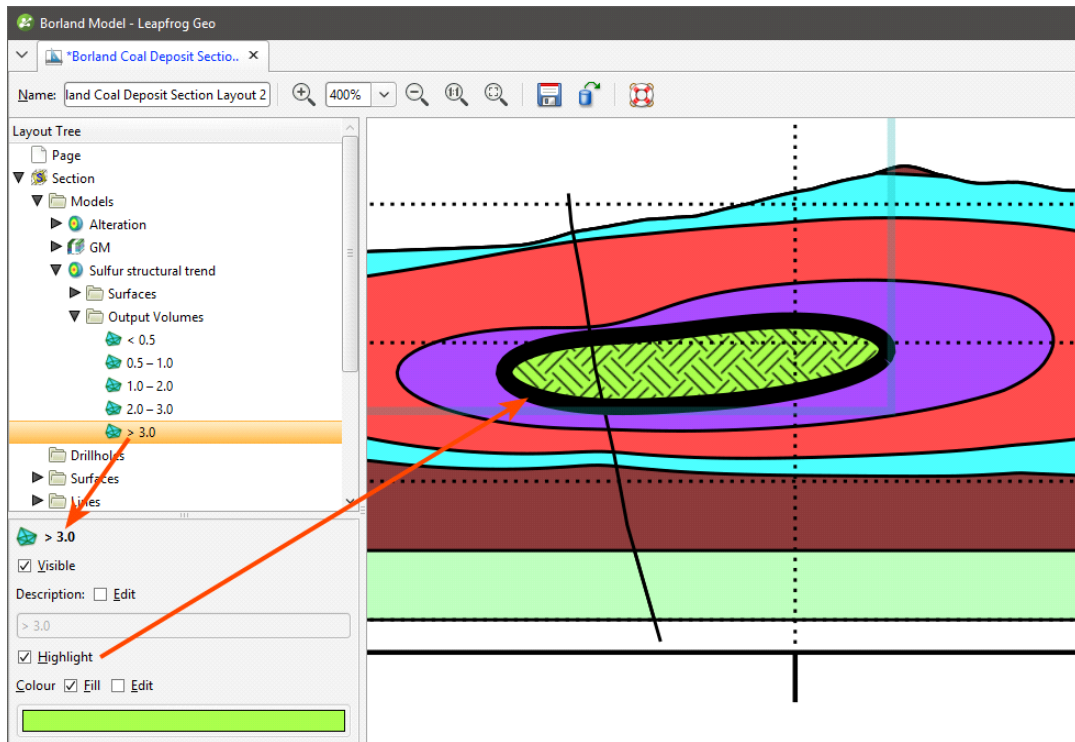

Another way to emphasise a particular volume is to use the surfaces in the model's **Surfaces** folder. This folder contains a single surface for every contact with the section, rather than a single surface for each contact surface in the model:

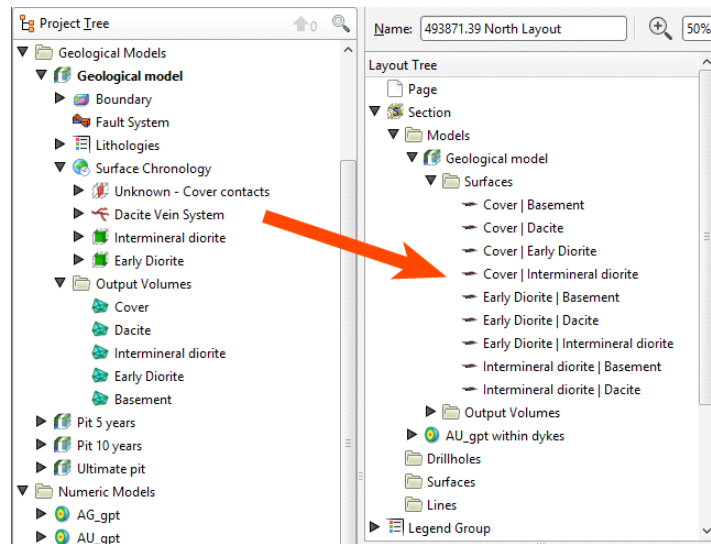

It can result in a large number of surfaces to work with, but does provide you more control over how these surfaces appear on the section layout. For example, here the outline of the GnD volume can be shown in different styles (as with the D2 contact) or not at all (as with the Dike contacts):

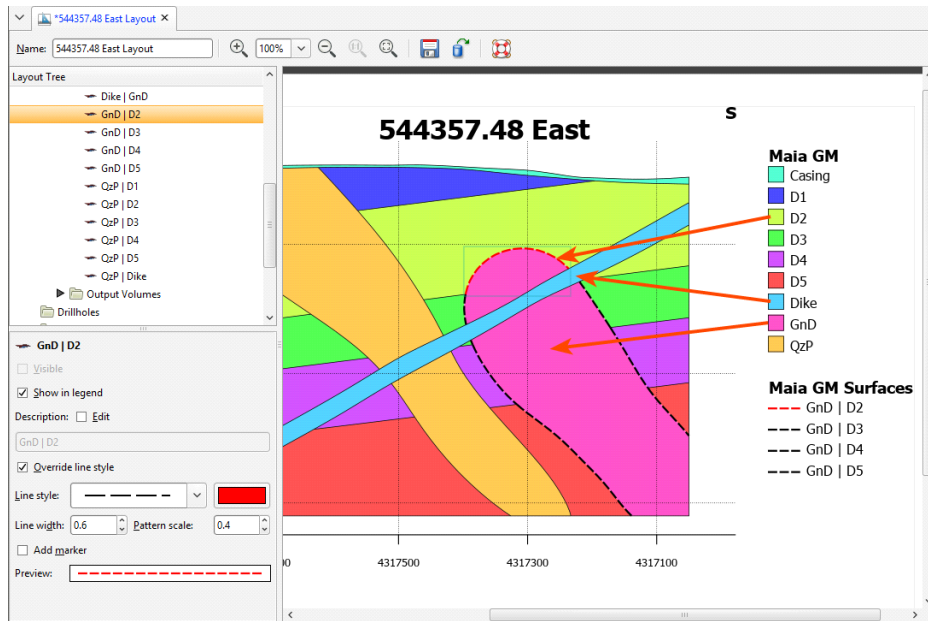

You can display a contact surface on a section layout as a surface evaluation, but you can have only one line style and you don't have control over what parts of the surface are displayed. For example, you cannot hide the surface where it is intersected by the dike:

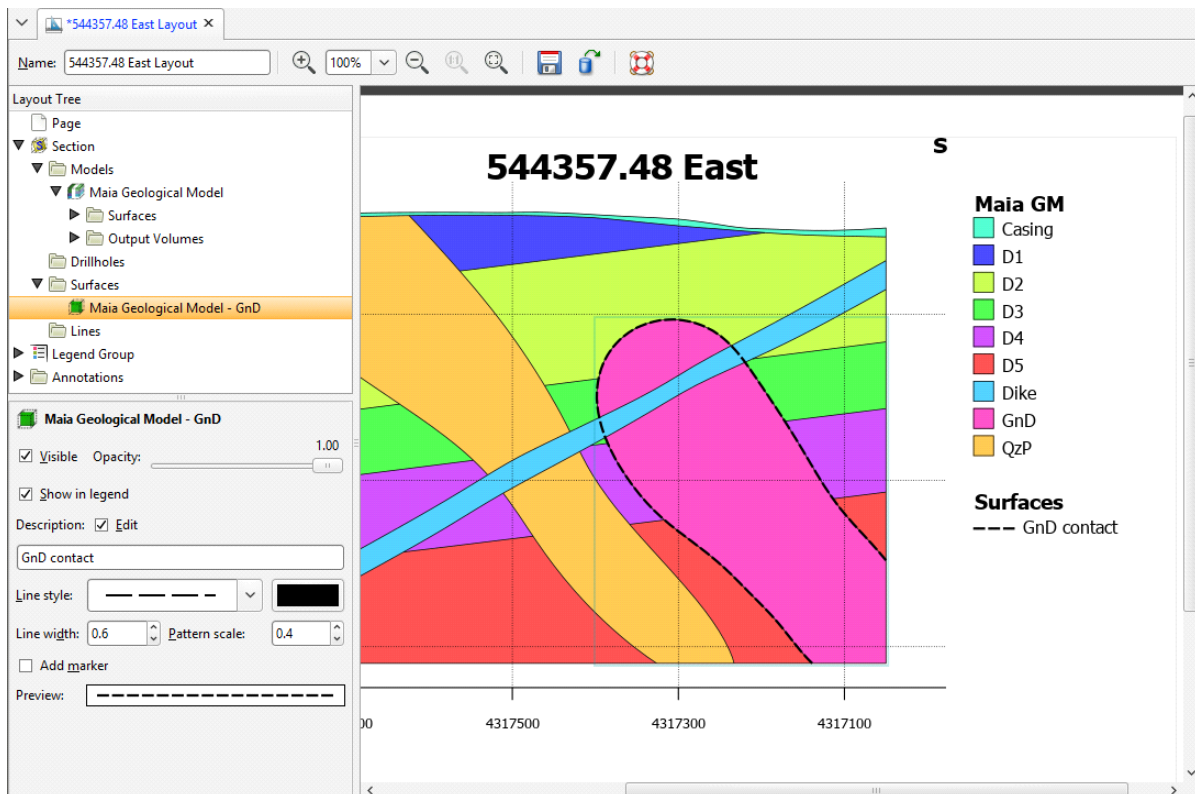

Flow models and block models appear in the **Models** folder as a single object. They can be displayed using a flat colour or any of the **Colouring** options available for the model:

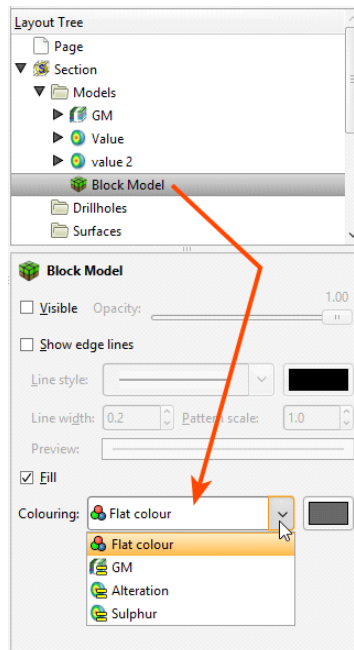

Click **Options** to change the colours used to display the model:

- For category evaluations, you can change what categories are visible and the colours used to display them.
- For numeric evaluations, you can filter values and use a different colourmap.

For example, here, a MODFLOW model is displayed using the **Colouring** from an evaluated geological model:

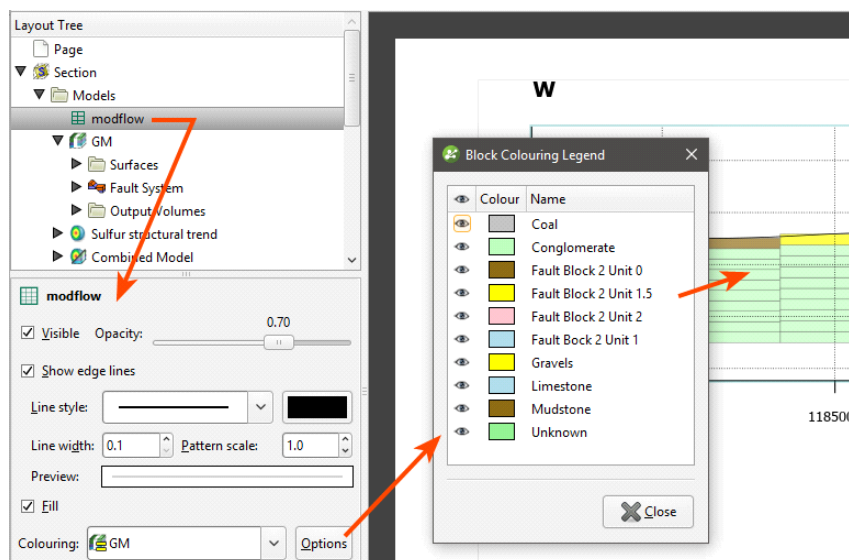

The colours used to display categories cannot be changed in the **Block Colouring Legend** as they are the colours used by the evaluated model itself. You can, however, hide some categories so they are not displayed on the section layout.

Here, the MODFLOW model is displayed using the **Colouring** from an evaluated numeric model:

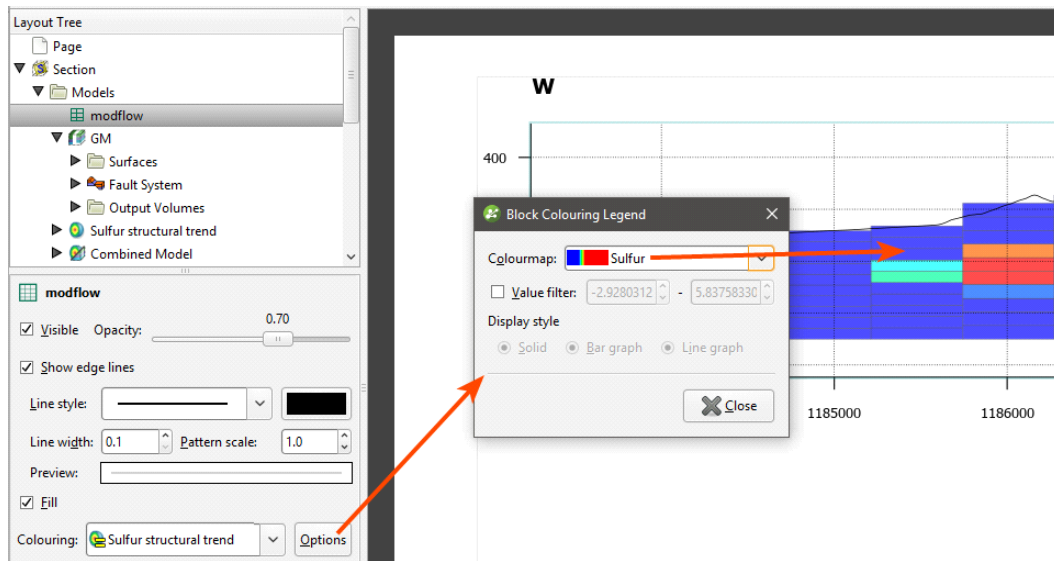

You can change the **Colourmap** used to display the model on the section and you can filter the values displayed.

If a block model or flow model is too big for the section layout, changing the section extents or the section layout extents will effectively “crop” the model and make it small enough to display on the section layout. There are two ways to do this:

- Change the section layout extents by clicking on **Section** in the **Layout Tree**, then clicking on the **Extents** tab. If **Extents** is set to **Evaluation Extents**, change it to **Section Extents**.
- Change the size of the section by double-clicking on it in the project tree and then editing its dimensions in the scene.

Adding Styling Drillholes and Planned Drillholes

The **Drillholes** folder contains all drillholes and planned drillholes that have been added to the section layout. Up to three columns of data can be displayed, and numeric data can be displayed as a graph.

To add drillholes to the section, right-click on the **Drillholes** object and select either **Add Drillholes** or **Add Planned Drillholes**.

For adding drillholes, you will be prompted to select the interval table to display.

For both drillholes and planned drillholes, you can filter the drillholes based on a minimum distance from the section plane:

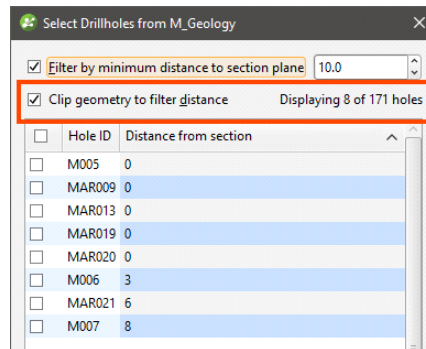

This is the minimum distance to any point on each drillhole trace.

If you tick the **Clip geometry to filter distance** option, only parts of the drillhole within the **filter distance** will be included in the section layout. Select the required drillholes and click **OK**.

When drillholes and planned drillholes are added to a curved section, a projection is made based on the locations of neighbouring segments of the section, using the bisectors of the angles between each segment and its neighbour. These determine the projection point of origin for a given segment of the section. When drillholes are filtered by the distance to the section plane, the distance is measured at 90 degrees from the section. Some drillholes may report a distance that is greater than the specified minimum distance; if this is the case, it is because the evaluation distance is relative to the projection origin.

On the inside of a tight corner, a single drillhole may be projected multiple times onto the section. If this is the case, the multiple instances of the drillhole will appear in the boreholes list and you can turn individual instances off, if required.

When a fence section is updated, drillhole evaluations are updated. If there are multiple instances of a drillhole evaluation, how they appear on the section may change when the section is updated:

- If all instances of a drillhole evaluation have been enabled, then all remain enabled when the section is updated.
- If all instances of a drillhole evaluation have been disabled, then all will remain disabled when the section is updated.
- If only some instances of a drillhole evaluation have been enabled, then all instances will be enabled when the section is updated.

When a section layout is copied to another section from a fence section, drillhole evaluations will not be copied with the section layout.

To hide or change the appearance of drillhole labels, click on the drillhole table, then on the **Points and labels** tab. Click **Options** to change how the labels are displayed. You can rotate labels and have a line connecting the label to the collar:

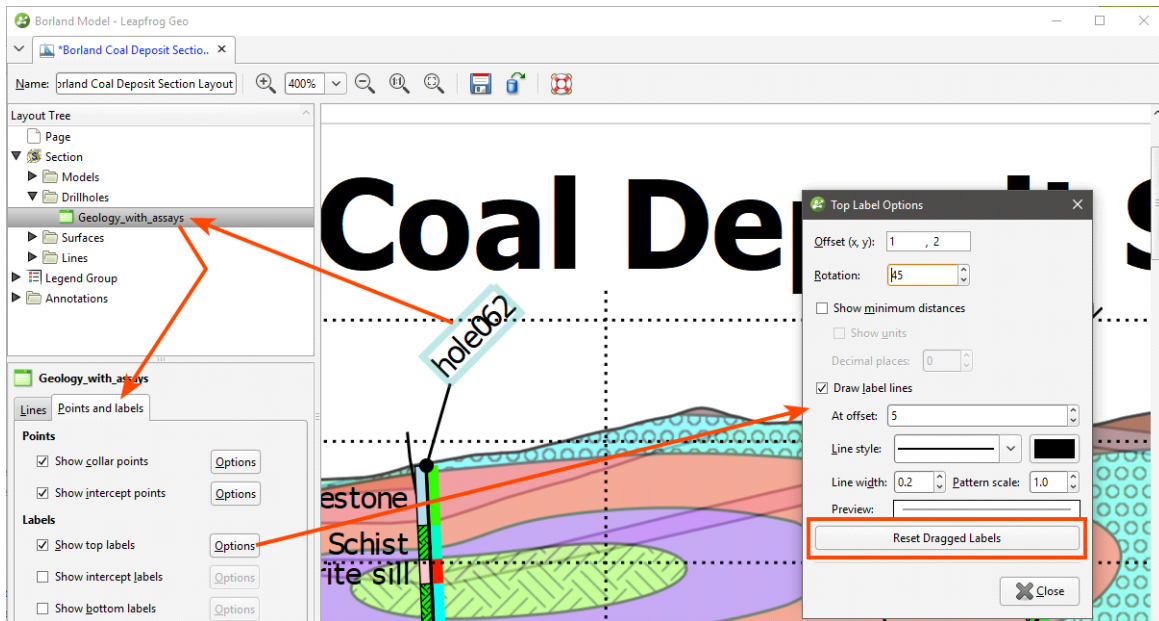

You can also click on the labels in the layout and move them. Note that the label lines will only appear once the drillhole label has been moved away from the collar.

If you want to return all labels to their default positions, click **Reset Draggged Labels** in the **Points and Labels > Label Options** window.

How drillholes are displayed is controlled by the **Colourings** settings in the **Lines** tab:

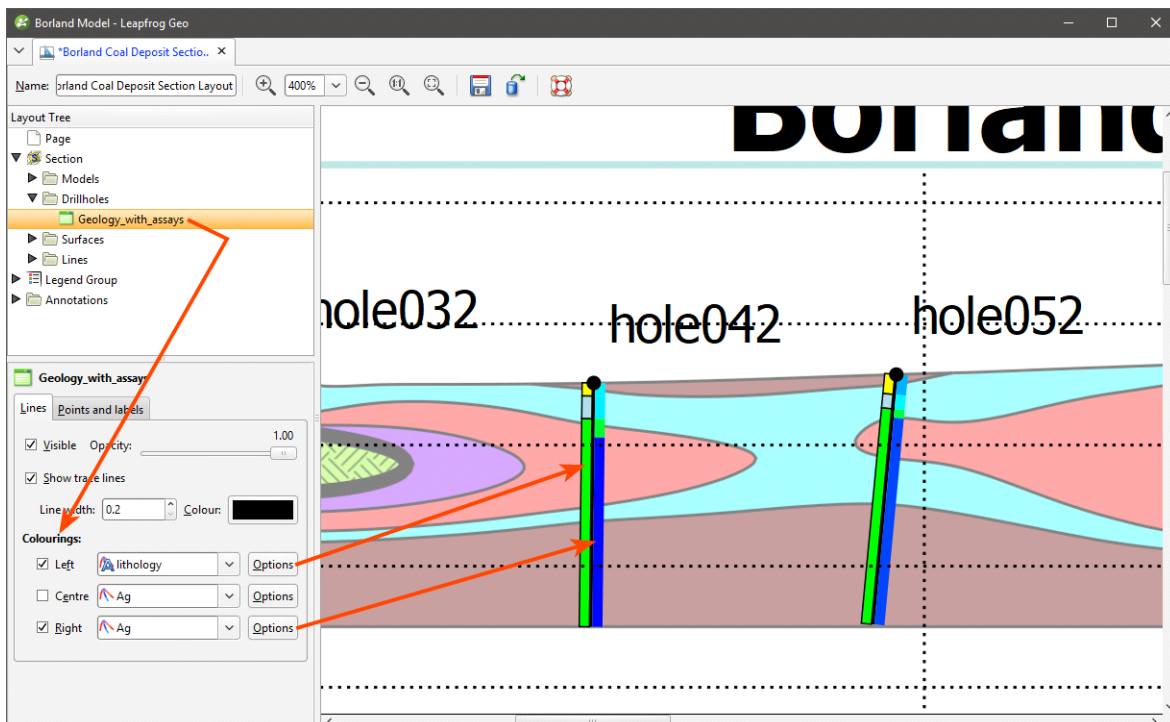

Click the **Options** button to display data (category data) or filter values (numeric data) on the drillholes:

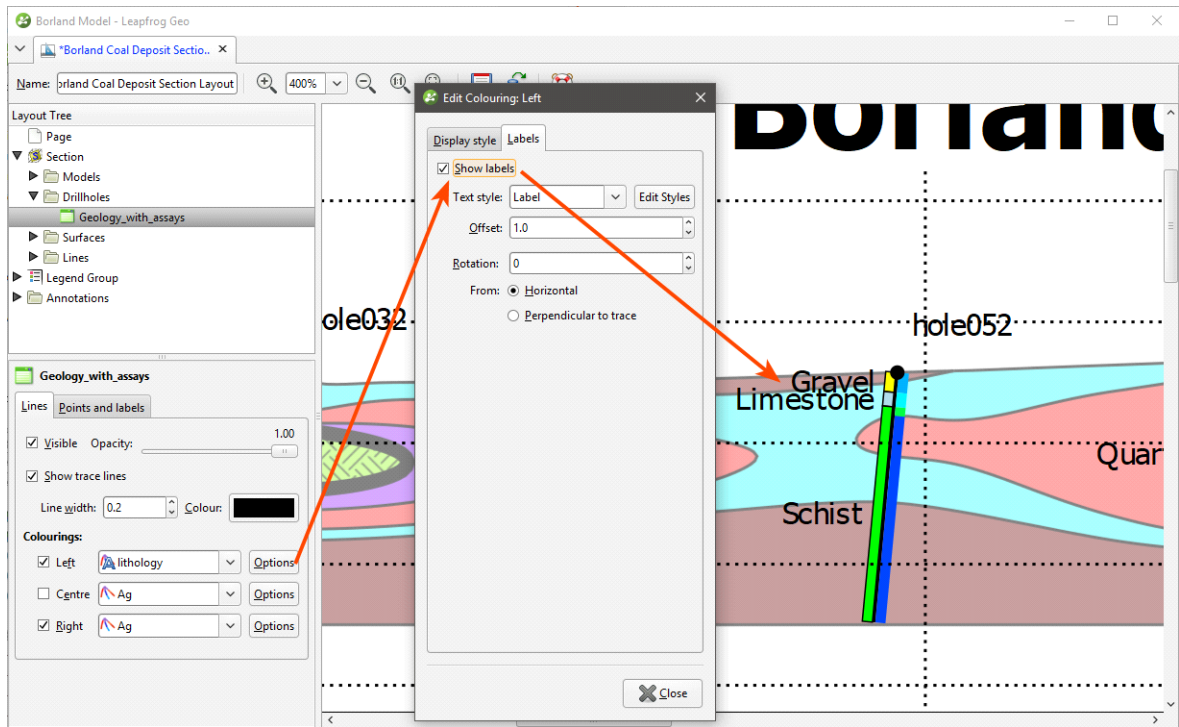

Drillholes can be displayed using hatching patterns. In the **Display style** tab, tick the **Hatched** option, then select from the patterns available:

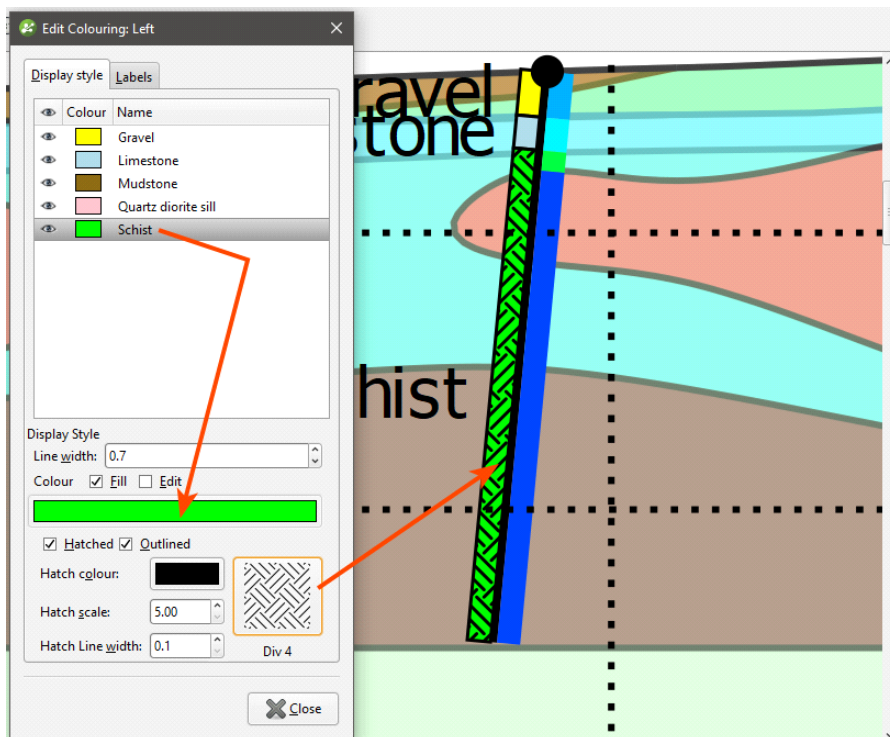

For columns of numeric data, you can display data as a bar graph or line graph. These options are available in the **Display style** tab. Here, data is displayed as a bar graph:

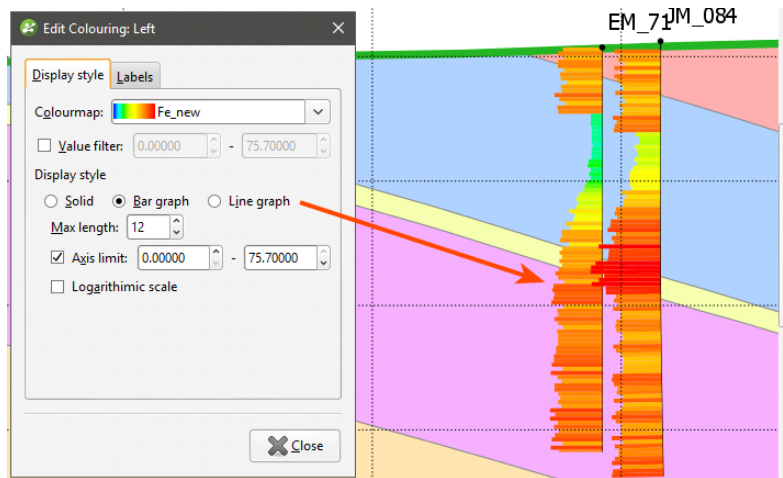

Select a **Max length** that means that displayed data does not interfere with other drillholes or data displayed on the section layout. This is especially useful when two graphs are displayed:

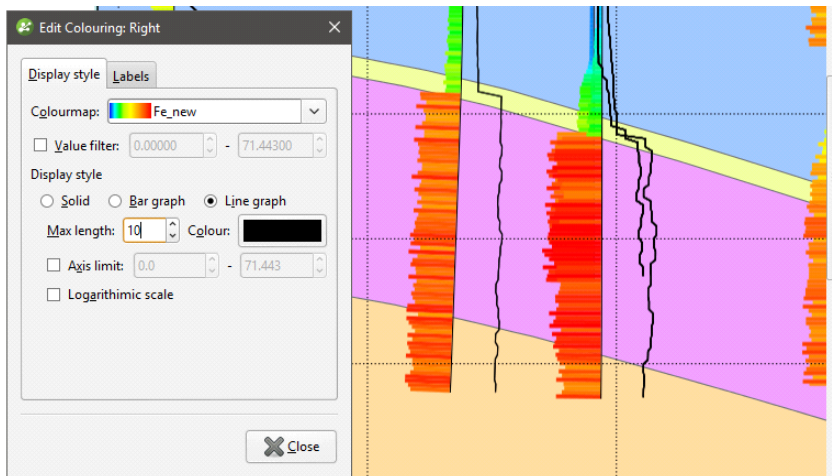

If you only want to plot a limited range of data, tick the **Axis limit** box and set the required range.

Displaying data with the logarithmic scale enabled may enhance differences in the values, and negative values can be scaled.

The bar and line graph options are not available for the centre of the drillhole, although the solid option can be used.

Adding and Styling Surfaces

The **Surfaces** folder contains all surfaces that have been added to the section layout. To add another surface, first make sure it has been evaluated on the section, then right-click on the **Surfaces** folder and select **Add Surface**. Select from those available and click **OK**.

Click on the surface in the **Layout Tree** to view styling options:

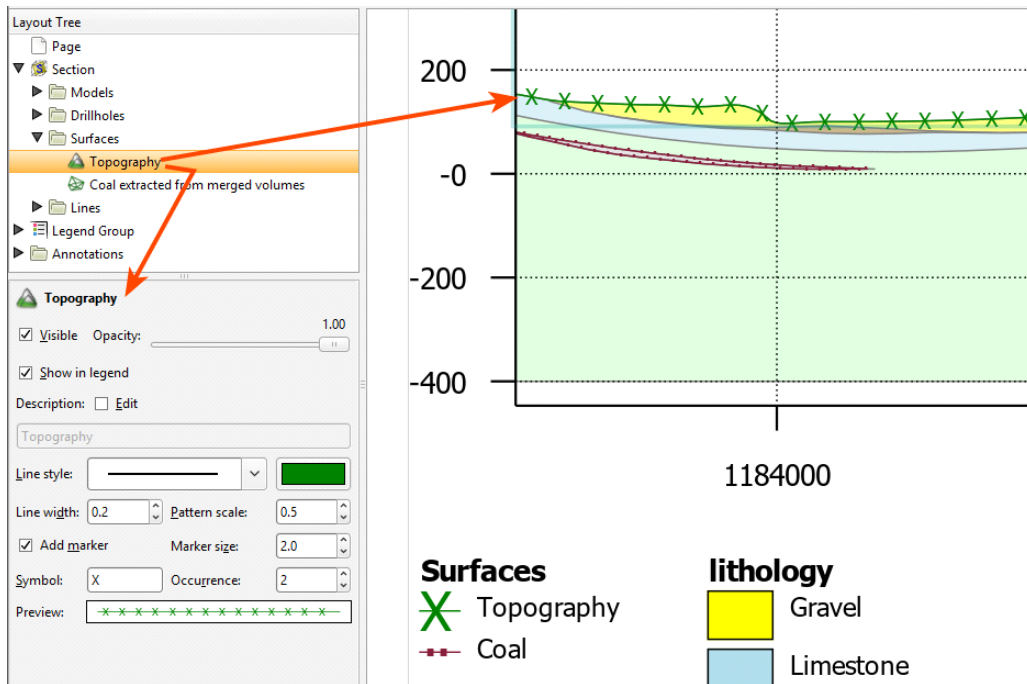

Edit the text used to display the surface by enabling the **Edit** box and then changing the text. You can change the **Line style**, **Line width**, **Pattern scale** and colour. You can also define a marker to display along the line by enabling **Add marker** and then specifying a **Symbol** to use. A **Preview** is displayed and the surface will be updated in the section preview.

You can see below how changes to the **Line style**, **Symbol** and **Occurrence** can be used to indicate different conditions:

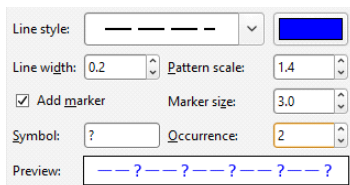

- Line style: Long dash
- Symbol: ?
- Occurrence: 2

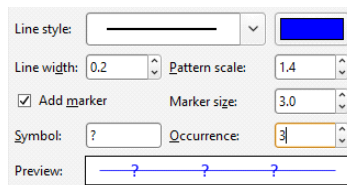

- Line style: Solid line
- Symbol: ?
- Occurrence: 3

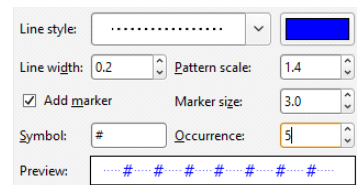

- Line style: Dotted
- Symbol: #
- Occurrence: 5

Adding and Styling Lines

The **Lines** folder contains all lines that have been added to the section layout. To add another line, first make sure it has been evaluated on the section, then right-click on the **Lines** folder and select **Add Line**. Select from those available and click **OK**.

Click on the line in the **Layout Tree** to view styling options, including the size, shape and colour of the pierce point:

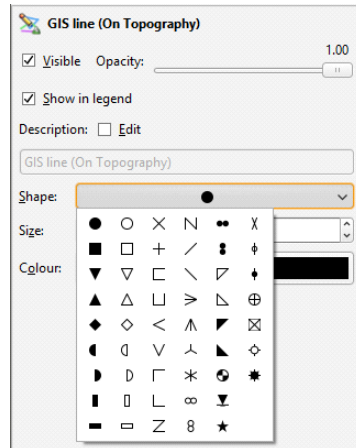

Setting Up the Legend

The **Legend Group** and the individual legends underneath it control how the legend is displayed on the page.

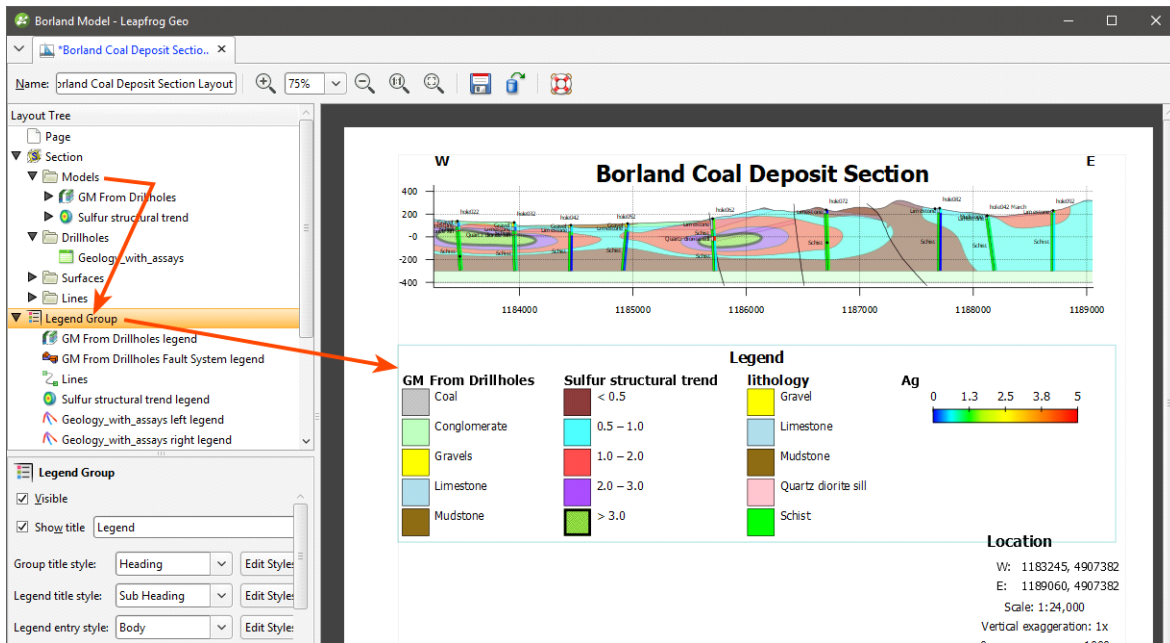

Click on the **Legend Group** object to change the layout of the legend as a whole:

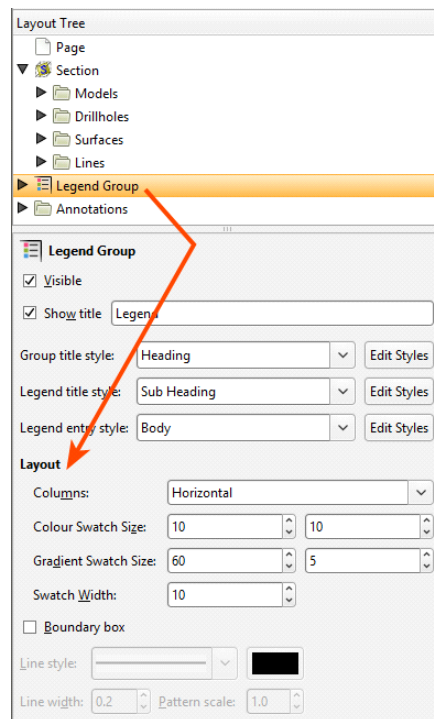

Columns can be laid out vertically or horizontally, and you can also change the swatch size and gradient and add a **Boundary box**. For individual legends that have a large number of entries, you may need to increase the number of rows. For example, for the combined model, the number of rows has been increased to accommodate the number of entries in the legend:

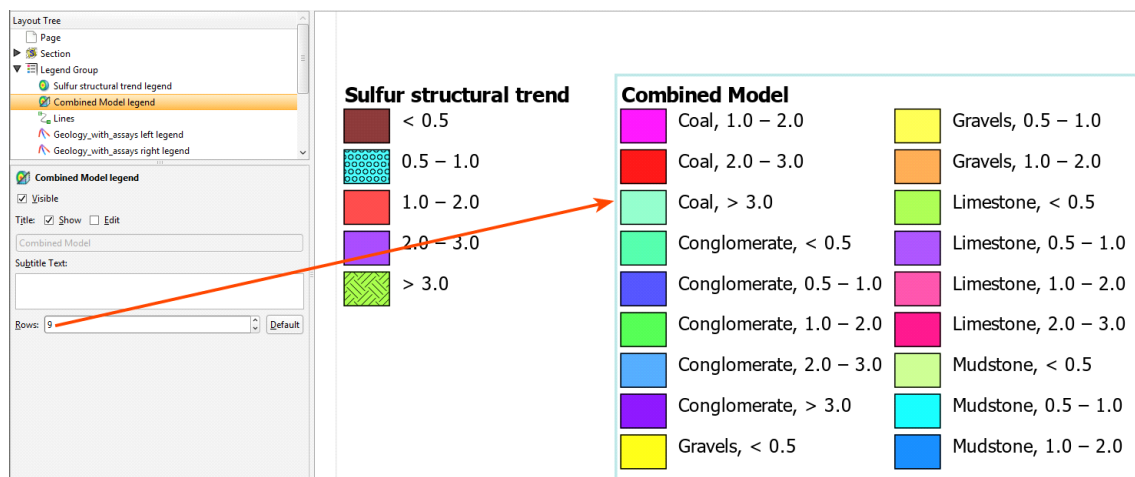

When you have multiple models, surfaces, lines and drillholes on the section layout, you can end up with a large number of entries in the **Legend Group**. How you hide a legend in the **Legend Group** depends on the type of object. Objects displayed on the section layout appear in the **Legend Group** as follows:

- Each model on the layout has an individual entry. Hide a model in the **Legend Group** by clicking on the model's entry and disabling the **Visible** option.

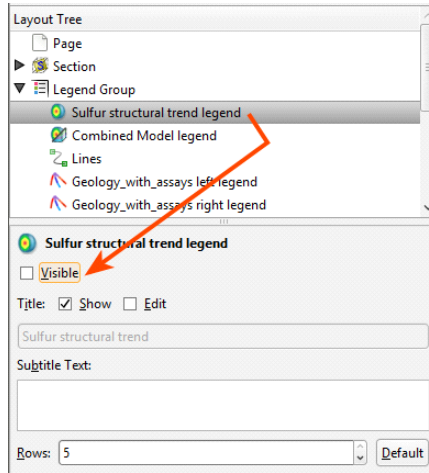

- Each geological model, numeric model and combined model has a **Surfaces** folder, which will have its own entry in the **Legend Group** when at least one surface in that folder has been set to **Show in legend**. The surfaces legend for a model itself can be hidden in the **Legend Group** by clicking on the entry and disabling the **Visible** option:

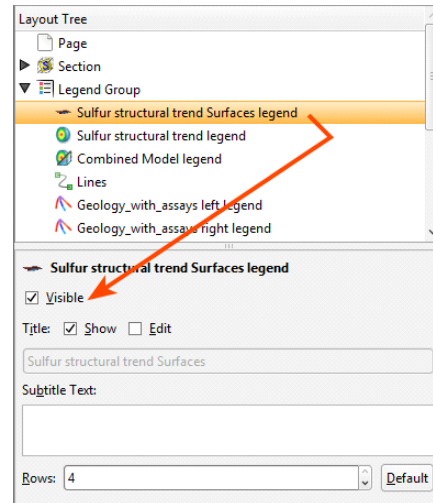
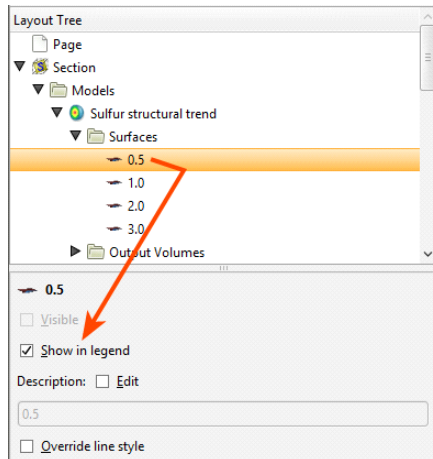

- Each drillhole column that appears on the section has an individual entry. Hide a column in the **Legend Group** by clicking on the column's entry and disabling the **Visible** option:

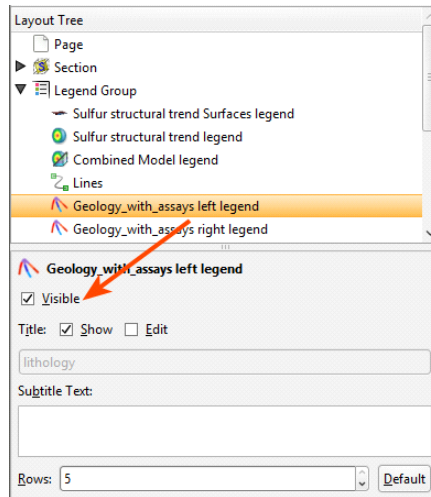

- Planned drillholes that appear on the section do not appear in the **Legend Group**.
- Surfaces in the **Section > Surfaces** folder appear in the **Legend Group** as a single entry. Hide a surface in the **Legend Group** by clicking on the surface in the **Surfaces** folder and disabling the **Show in legend** option:

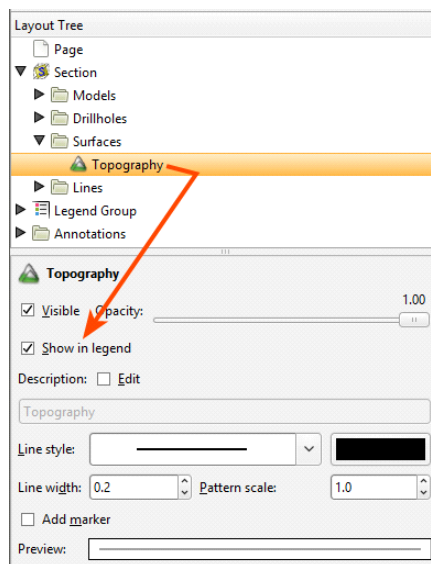

- Lines in the **Section > Lines** folder appear in the **Legend Group** as a single entry. Hide a line in the **Legend Group** by clicking on the line in the **Lines** folder and disabling the **Show in legend** option:

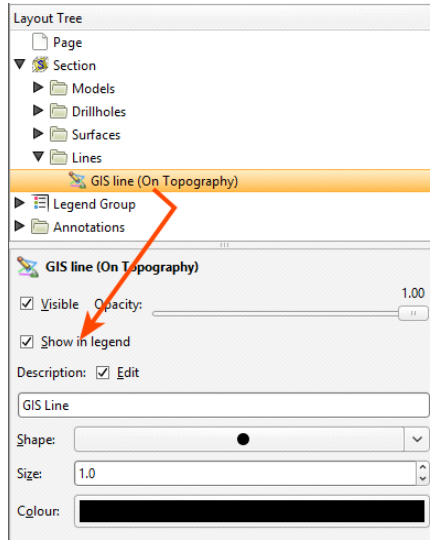

The order in which legends appear in the **Legend Group** is the order in which they appear in the **Layout Tree**. To change the order in which the legends appear, right-click on them and select a **Move** option.

The colours, line widths, fills and hatches displayed in the **Legend Group** are controlled by the objects themselves. For example, to change how a shell is displayed for the interpolant, click on the output volume, under the **Models** object:

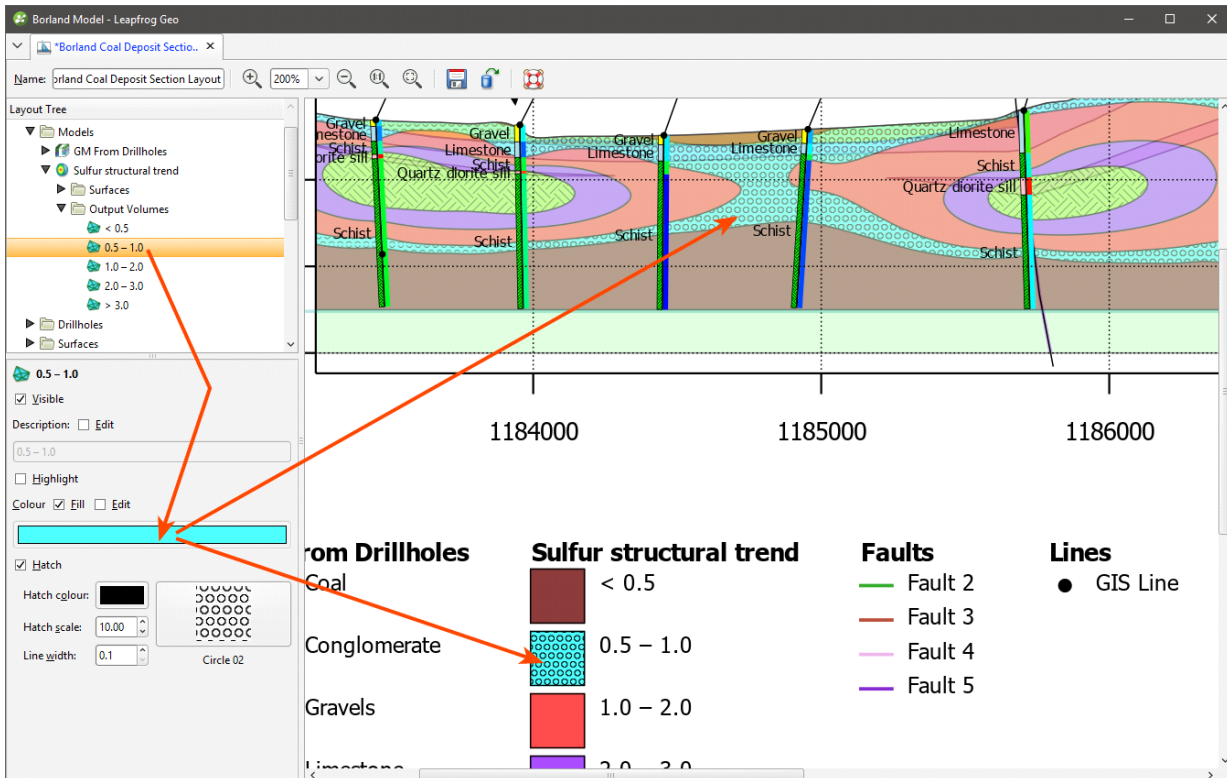

Adding and Organising Annotations

Once you have laid out the main **Section** object and organised the **Legend Group**, you can add a number of different types of annotation to the layout, including a title, a title block, location

information and a scale bar, text boxes and imported images.

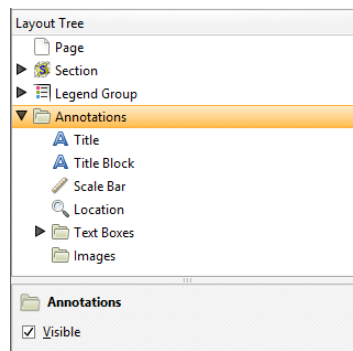

Displaying a Title

The **Title** object formats the title displayed on the page. To move the title, click on it in the layout preview. The text used for the **Title** is the name for the section in the project tree, but this can be changed in the properties panel. Enable the **Edit** option, then edit the text in the box:

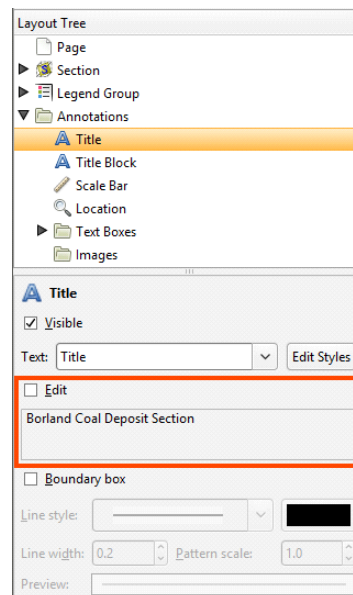

You can display a line around the **Title** by enabling the **Boundary box** option. You can customise the **Line style**, **Line width**, **Pattern scale** and colour of the box. A **Preview** is displayed and the boundary is updated in the section preview.

Displaying a Title Block

When the **Title Block** is visible, a title block based on ISO 7200 is displayed on the layout:

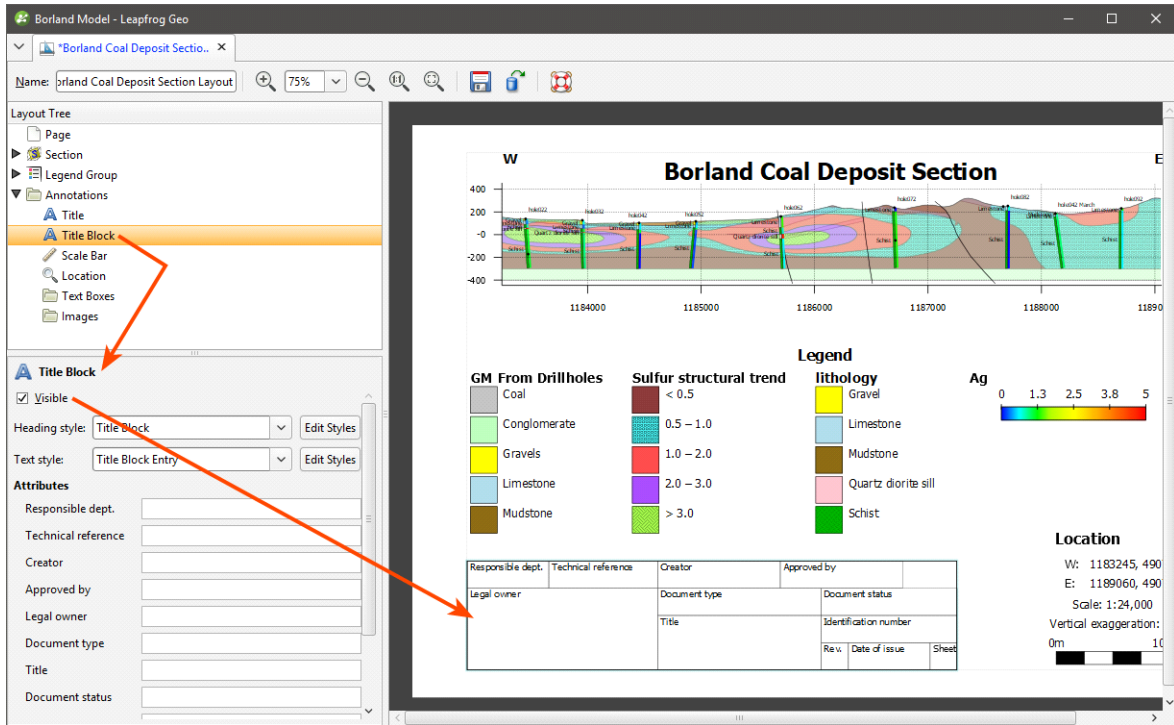

To display the **Title Block** on the section, select it in the **Layout Tree**, then tick the **Visible** box. In this panel, you can also change the styles used to display the information in the block.

Displaying a Scale Bar and Location Information

There are a number of different styles available for the **Scale Bar**, and you can control its **Length**, **Partitions** and **Thickness**:

The screenshot displays a software interface with a **Layout Tree** on the left and a map view on the right. The **Scale Bar** is selected in the layout tree, and its properties are shown in the **Scale Bar** panel. The **Scale Bar** panel includes the following settings:

- Visible:**
- Scale Bar:**
 - Length:** 1500
 - Partitions:** 4
 - Bar style:** [Pattern selection]
 - Thickness:** 5.0
 - Line width:** [Pattern selection]
 - Colour:** [Color selection]
- Scale Bar Labels:**
 - Show Labels
 - Show Units
 - End Points Only
 - Text Style:** Scale Labels
- Text:**
 - Show scale
 - Text Style:** Body
 - Show vertical exaggeration
 - Text Style:** Body
 - Boundary box
 - Line style:** [Line style selection]
 - Line width:** 0.2
 - Pattern scale:** 1.0

The map view shows a scale bar with a length of 1500 units, divided into 4 partitions. The scale bar is labeled with 0m and 1500m. The map also displays a **Location** information box with the following coordinates:

Location
 W: 1183245, 4907382
 E: 1189060, 4907382

Below the location information, the scale is indicated as **Scale: 1:24,000** and **Vertical exaggeration: 1.5x**. A red arrow points from the **Line width** property in the **Scale Bar** panel to the scale bar on the map.

You can show the **Scale Bar** with or without labels, and labels can be shown all along the bar by disabling the **End Points Only** option:

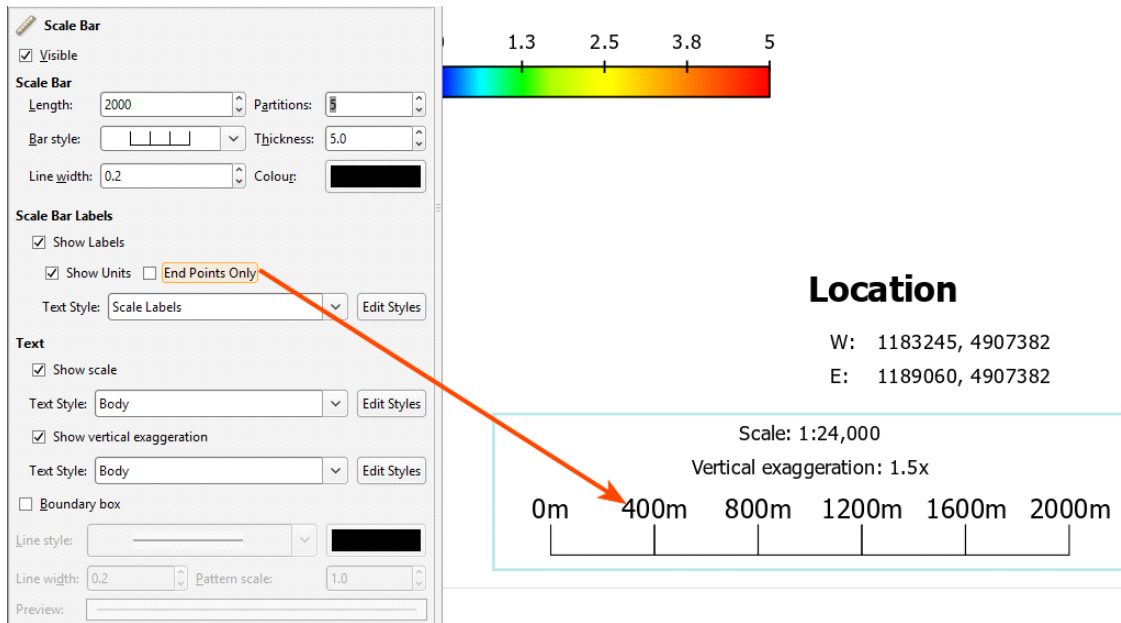

The **Text** options determine whether or not the scale and vertical exaggeration are shown on the scale bar.

The **Location** object controls how location information is displayed:

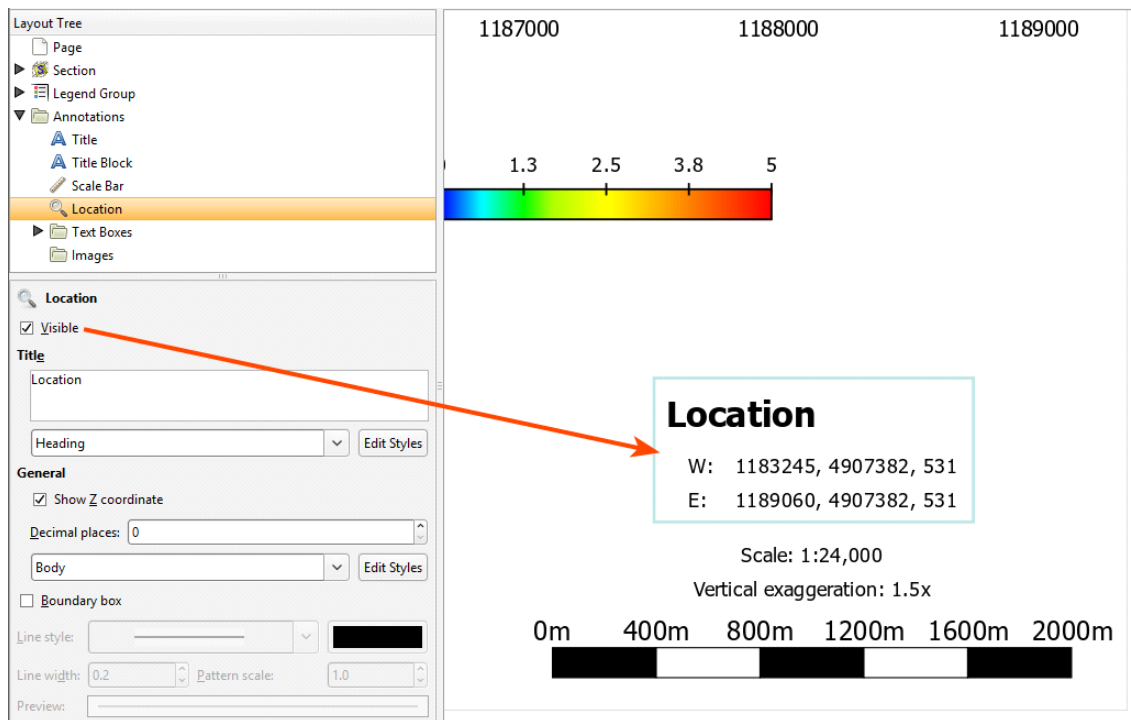

You can include the Z coordinate, if required and change the number of decimal places used to display coordinates.

There is a **Boundary box** option for both the **Scale Bar** and the **Location**. You can customise the **Line style**, **Line width**, **Pattern scale** and colour of the box. A **Preview** is displayed and the boundary is updated in the section preview.

Text Boxes

With the **Text Boxes** object, you can add text boxes and arrows to highlight information and details on the section:

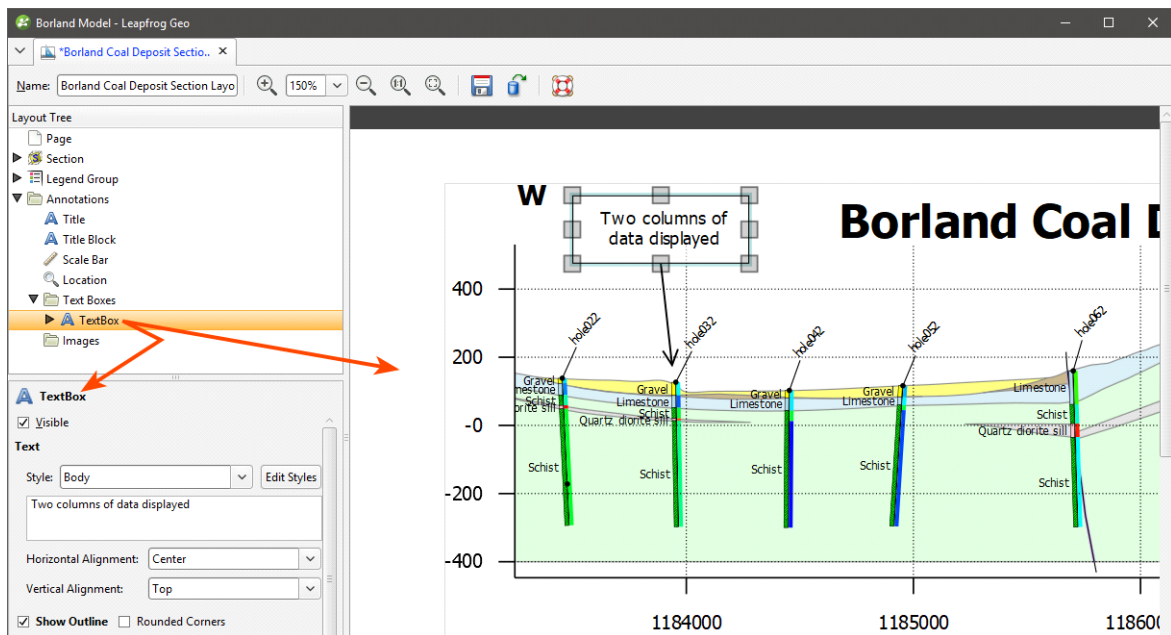

There is a **Show Outline** option for the text box, and corners can be square or rounded. You can customise the **Line style**, **Line width**, **Pattern scale** and colour of the outline. A **Preview** is displayed and the text box is updated in the section preview.

Arrows are connected to text boxes, and so initially only text boxes can be added. Right-click on a text box to add an arrow to it. When the **Automatic anchoring** option is enabled for an arrow, the arrow's anchor will move when its associated text box is moved:

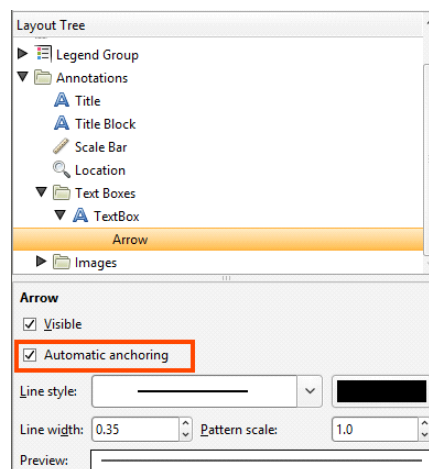

If this option is disabled, the arrow will move when you move the text box, but you will have to place its anchor manually.

Images

If you wish to import an image such as a logo or map, right-click on the **Images** object and select **Add Image**. Navigate to the folder that contains the image file and select the file. Click **Open** to import the file, which will automatically be added to the section layout:

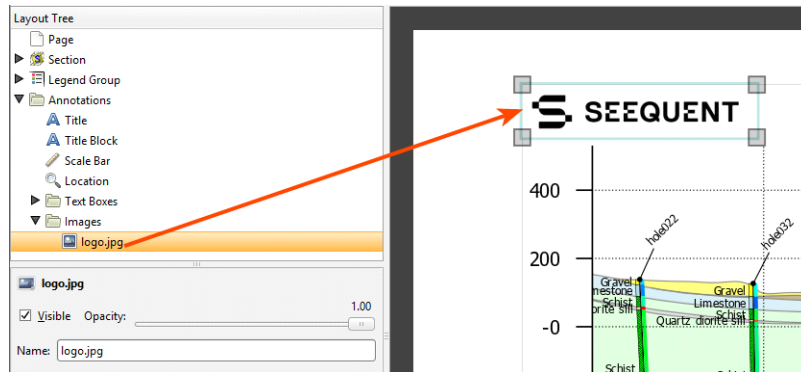

Move the image by clicking on it in the preview and dragging it. You can resize the image using the controls in the preview.

Rendered Images

Leapfrog Geo can render high-quality images that you can save on your computer in a format that can be used in presentations and documents. To do this, click on the **Render Image** button in the toolbar (🖨️) or click on the **Leapfrog Geo** menu and select **Render Image**. Leapfrog Geo renders an image from the current scene window, then displays it in the **Render Image** window:

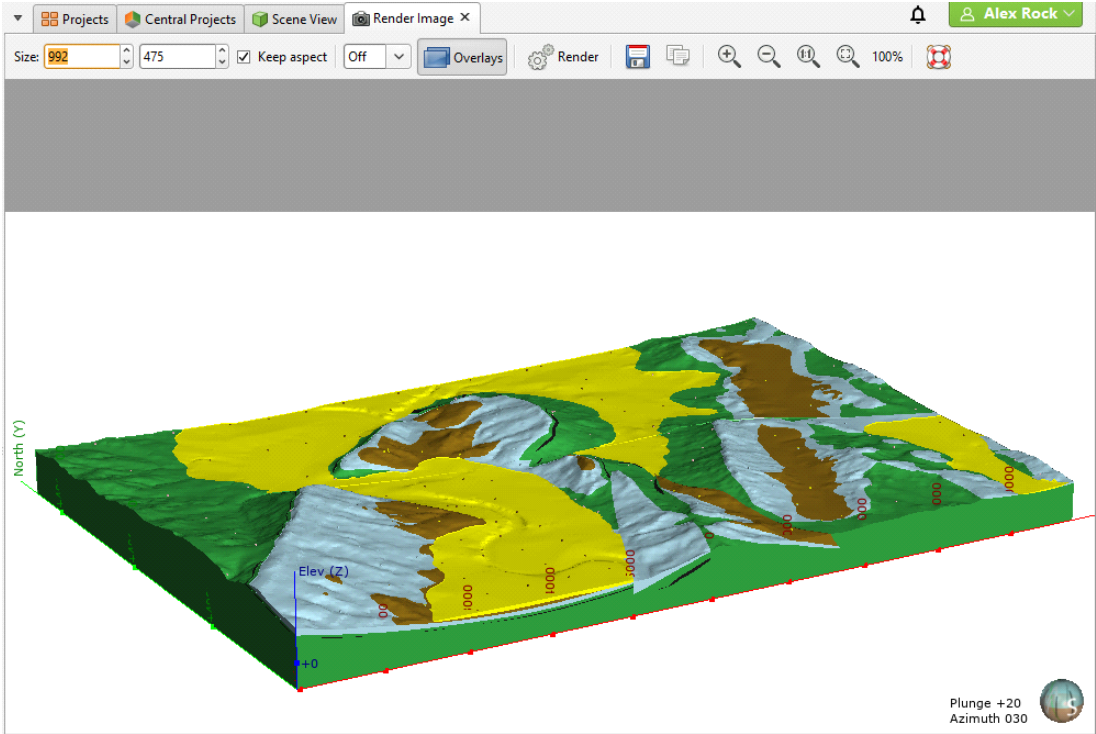

If you are displaying multiple views in the scene, you can select which ones you want to render from the **Render View** list:

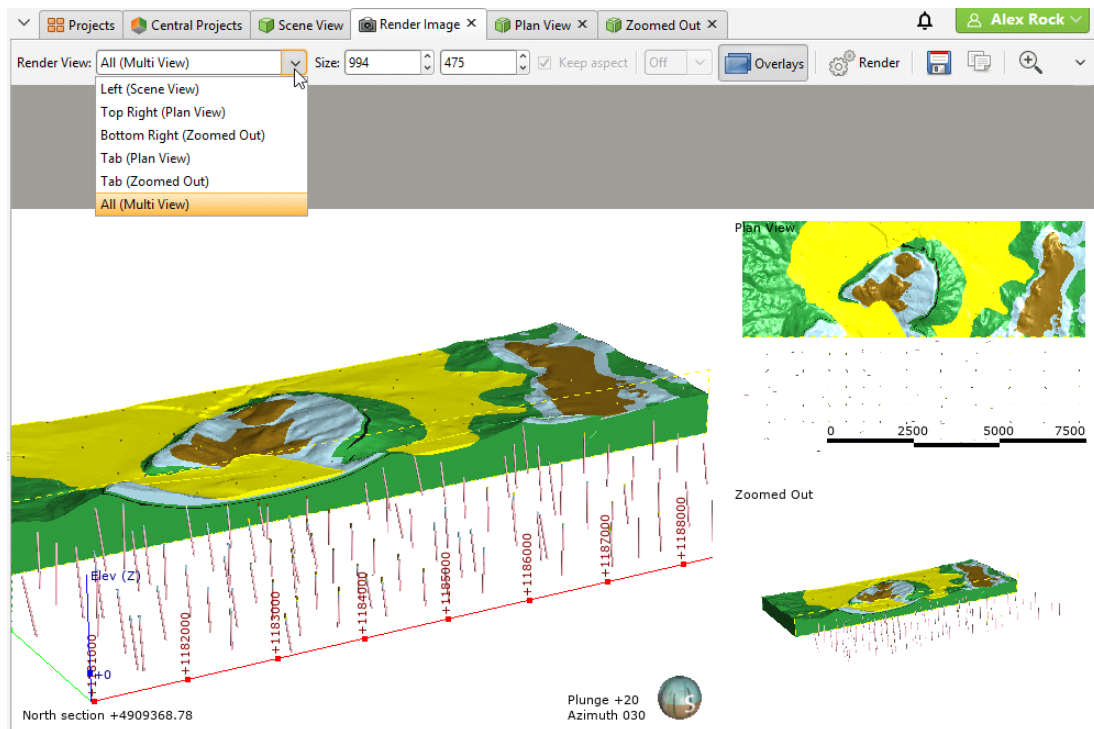

Views that are open in tabs are also listed in the **Render View** list. However, the **All (Multi View)** option only renders the split of views displayed in the **Scene View** tab.

Use the zoom tools to view the rendered image. You can change the image settings by:

- Selecting a new image size. To constrain the image's proportions when changing size, tick the **Keep aspect** box.
- Changing supersampling options to smooth jagged edges. Select the required option from the list. The highest sampling option (**4x4**) will take longer to process than the lowest sampling option or turning supersampling off.
- Viewing the image with or without overlays. See [Overlay Settings](#) for more information about further customising the overlays displayed in the scene.

Click the **Render** button to update the image with the changed settings. Once you are satisfied with the rendered image, click **Save**. You will be prompted to enter a filename and location.

Background Rendering

You can keep the **Render Image** tab open while continuing to work in your project, which is useful for rendering a series of images. To work in this way, dock the **Render Image** tab adjacent to the scene window. When you have set up your scene, right-click on the **Render Image** tab and choose one of the options:

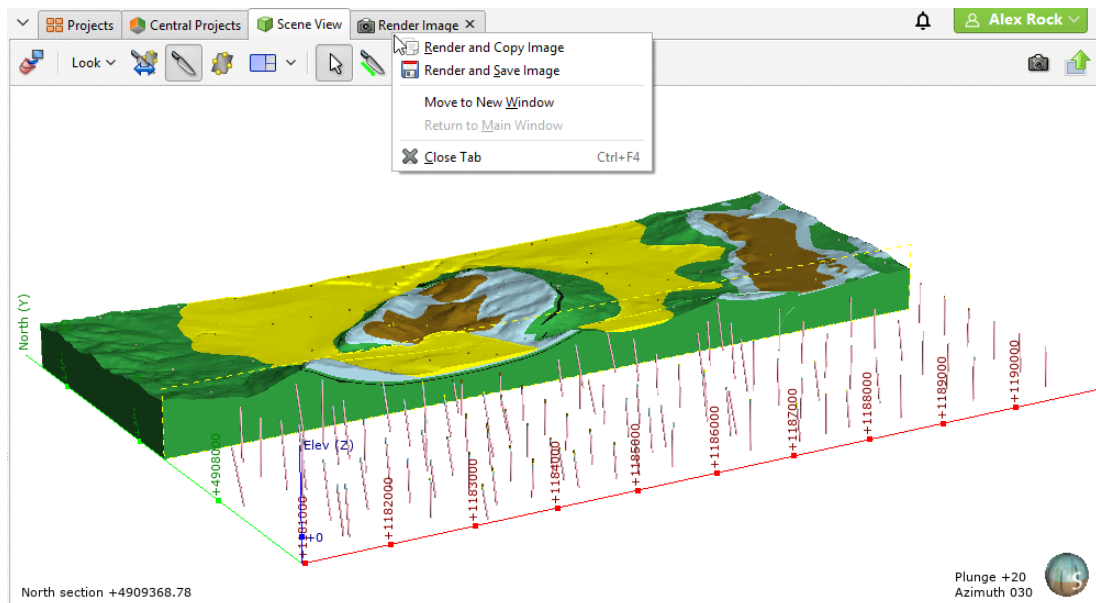

The **Render and Copy Image** option will render a new image from the scene and copy it to the clipboard.

The **Render and Save Image** option will render a new image and prompt you for a filename and location.

Saved Scenes

A saved scene is a way of storing the shape list and settings so that the scene can be retrieved later. Saved scenes are the basis of scene files exported to Leapfrog Viewer and Leapfrog Aspect. Saved scenes are also used in creating movies, which is described in the [Movies](#) topic.

This topic describes:

- [Saving Scenes](#)
- [Exporting Scenes](#)
- [Exporting Scenes for Leapfrog Aspect](#)
- [Linking to Scene Files](#)

A saved scene is, in effect, a bookmark of a specific view of the project data. A saved scene does not maintain an independent copy of the data in the project, and so if the data changes, then the appearance of the scene will also change.

When a scene is saved, comments can be entered documenting what is in the scene. Saved scenes provide a stable point of reference in a project and can explain important aspects of the

project, which is especially useful for explaining aspects of a model to others using the project or viewing scene files.

Saving Scenes

To save the current scene, right-click on the **Saved Scenes and Movies** folder and select **Save Current Scene**. The **Save Scene** window will be displayed:

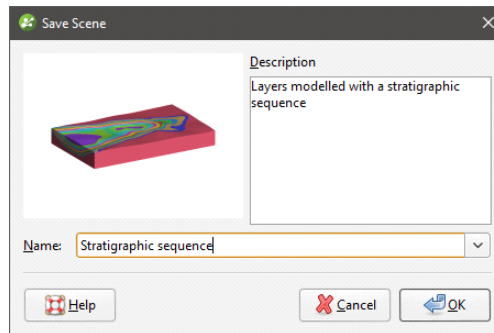

Enter a name and description for the scene and click **OK**. The scene will be saved and added to the **Saved Scenes and Movies** folder.

When you save a scene, the properties settings in the shape list are saved for the objects displayed in the scene. For example, if a lithology table is displayed with the legend in the scene, the legend will be displayed when the scene is restored. However, saved scenes do not store copies of the objects in the project tree, and objects deleted from the project tree are no longer available in saved scenes.

To edit a scene, double-click on it. The **Edit Saved Scene** window will be displayed and you can update the information.

To display a scene, drag it into the scene.

Exporting Scenes

Once you have a series of saved scenes, you can use them to create a scene file that can be opened in Leapfrog Viewer or Leapfrog Aspect. See [Exporting Scenes for Leapfrog Aspect](#) for points to consider when creating scene files that will be opened in Leapfrog Aspect.

To export a scene, right-click on the **Saved Scenes and Movies** folder and select **Export Scenes**. The **Export Scenes** window will be displayed:

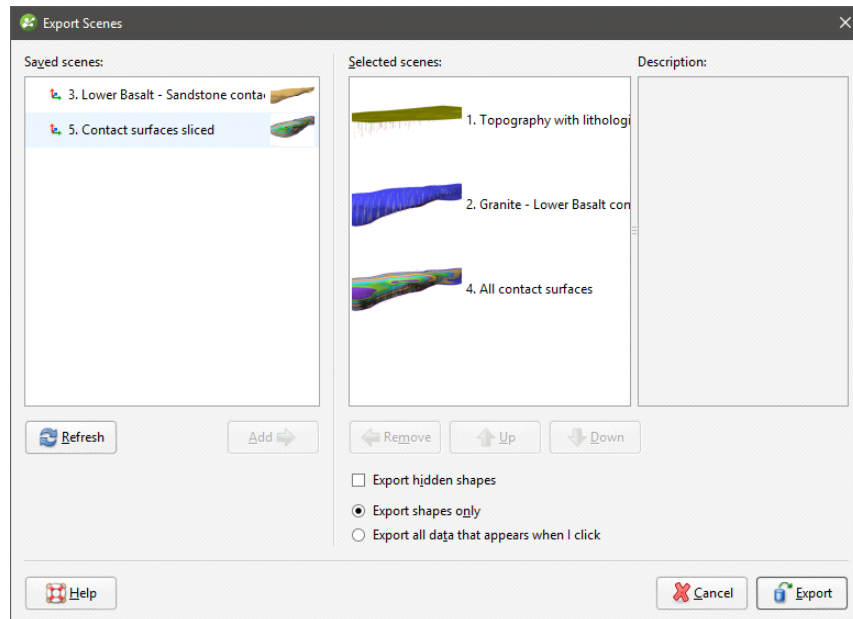

You can also export an individual scene by right-clicking on the scene and selecting **Export**.

Move the scenes you wish to export to the **Selected scenes** list and reorder them, if required.

If you tick the **Export hidden shapes** box, objects in the shape list that are not visible in the scene window will be included in the exported scene.

You can also export the data associated with the objects in the scene window, if required. To do so, select the **Export all data that appears when I click** option. If viewing the data is not required, or if you wish to keep sensitive data secure, select the **Export shapes only** option.

When the **Export all data that appears when I click** option is selected, all data represented by shapes in the exported scene will be accessible when the scene is opened in Leapfrog Viewer.

When you have the scenes arranged, click **Export**. You will be prompted for a filename and location.

Exported scenes cannot be reimported to the project.

Exporting Scenes for Leapfrog Aspect

When exporting scenes for use in Leapfrog Aspect, keep in mind the following:

- When viewing 3D data on a 2D screen, objects may appear closer or further from the viewer than expected. For this reason, it is a good idea to include a current topographic surface in the dataset to aid in orienting the view relative to the camera feed.
- Although newer Android devices have a significant amount of processing power, they are not as graphically capable as a typical desktop computer. Try to limit the amount of data to

be displayed as there are likely to be issues if a scene contains 10,000 drillholes or a million points.

- Scenes with complex wireframes will load more slowly than simple wireframes. It is a good idea to make a simplified copy of a wireframe in Leapfrog Geo and use that wireframe to create a scene.
- Both **Export all data that appears when I click** and **Export shapes only** options will work for Leapfrog Aspect. If you wish to display collar IDs, use the **Export all data that appears when I click** option, but keep in mind that displaying hole IDs can be slow and choppy.

Linking to Scene Files

Links to scene files can be included in HTML files using the following format:

```
<a href="LeapfrogViewer:[path or URL]">link text</a>
```

Linked scene files will be opened directly in Leapfrog Viewer only from browsers that support custom URI schemes.

Movies

Once you have a series of saved scenes (see [Saved Scenes](#)), you can use them to create a storyboard and export a movie.

To create a new movie, right-click on the **Saved Scenes and Movies** folder and select **New Movie**. A tab will open in which you can create a storyboard and edit how each scene and transition is displayed. You can detach the tab from the main window and create scenes in the main window while working on scenes in the movie tab. Click the **Refresh Scenes** button to refresh the scenes in the movie tab when you have made changes.

Select the saved scenes you wish to add to the movie by clicking on them in the list, then click the **Add To Storyboard** button (📁+). When subsequent scenes are added, transitions will be added to separate the scenes:

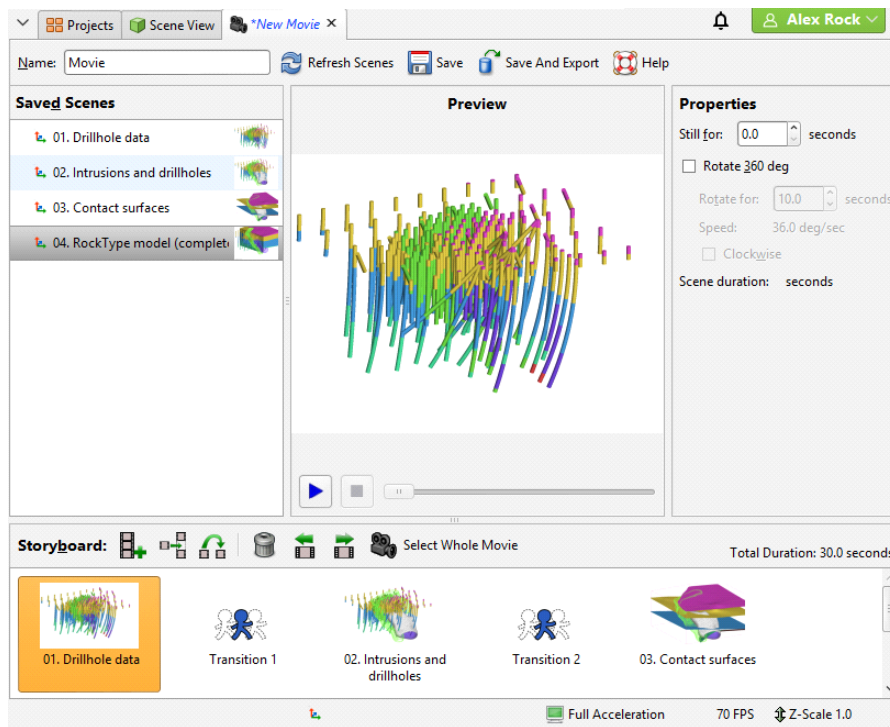

Change properties for the selected scene or transition, then click the play button (▶) to preview the settings. To preview the whole movie, click the **Select Whole Movie** button (🎬), then click play.

You can make changes to the included scenes without having to close and reopen the movie window. Simply update the scenes, then, in the movie editor, click the **Refresh Scenes** button.

Enter a name and description for the movie and click the **Save** button (💾). The movie will be saved in the **Saved Scenes and Movies** folder.

To export the movie, click the **Save and Export** button (📁). The **Export Movie** window will appear:

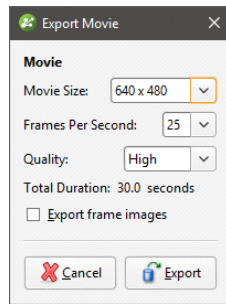

If you tick **Export frame images**, individual frames will be saved as images, together with the movie file. Click **Export**. You will be prompted to select a filename and location. Click **Save** to export the movie. Leapfrog Geo will then save the movie in the specified location, which may take some time.

Contour Lines

You can create contour lines from surfaces in the project and export those contour lines to GIS packages.

Creating Contour Lines

To create contour lines from a surface, right-click on the **Cross Sections and Contours** folder and select **New Contour Lines From Surface**. In the **New Contours** window, select the surface to contour from the list. Adjust the **Contour Spacing**, if required.

If you want to offset the contours by a vector, enter a **Contour offset** value.

Click **OK** to generate the contours.

The new contours will appear in the project tree under the **Cross Sections and Contours** folder.

You can edit the contours by double-clicking on them.

Exporting GIS Contours

To export a contour lines object, right-click on the contour lines in the **Cross Sections and Contours** folder and select **Export**. Select whether or not to export the contours in 2.5D format, then click **Export**. You will be prompted for a filename and location.