

User Manual

for Leapfrog Geothermal version 3.8

© 2019 Seequent Limited (“**Seequent**”). All rights reserved. Unauthorised use, reproduction, or disclosure is prohibited. Seequent assumes no responsibility for errors or omissions in this document. LEAPFROG, SEEQUENT and  are trade marks owned by Seequent. All other product and company names are trade marks or registered trade marks of their respective holders. Use of these trade marks in this document does not imply any ownership of these trade marks or any affiliation or endorsement by the holders of these trade marks.

Contents

Getting Started	1
Licensing Leapfrog Geothermal	1
Dongle Licences	1
Code Licences	2
Signing in to My Leapfrog	2
Graphics and Drivers	2
Switching to High-Performance Graphics	3
Running the Graphics Test	5
The Leapfrog Geothermal Projects Tab	7
Managing Leapfrog Geothermal Projects	8
Saving Projects	8
Saving Zipped Copies of Projects	8
Saving Backup Copies of Projects	8
Compacting Projects	9
Upgrading Projects	9
Converting Leapfrog Geo Projects	9
What is Implicit Modelling?	10
What are the Advantages of Implicit Modelling?	10
Implicit Modelling Makes Assumptions Explicit	11
Best Practices	11
An Overview of Leapfrog Geothermal	13
Keyboard Shortcuts in the Main Window	14
The Project Tree	15
Organising Objects in the Project Tree	18
Subfolders	18
Copying Objects	19
Renaming Objects	19
Finding Objects	20
Deleting Objects	20
Sharing Objects	21
Object Properties	21
Comments	22
Processing Tasks	23
Prioritising Tasks	23
Correcting Errors	24

Project Tree Keyboard Shortcuts	24
The 3D Scene	25
Locating an Object from the Scene	28
Clicking in the Scene	29
Clicking in the Shape List	30
Slicing Through the Data	31
Slicer Properties	32
Object Slice Mode	33
Slicer Shortcuts	33
Measuring in the Scene	34
Determining a Location	35
The Moving Plane	36
The Ruler	37
Working With Split Views	39
Visualising Data	43
Colour Options	44
Single Colour Display	45
Colourmaps	45
Category Colourmaps	47
Numeric Data Colourmaps	47
Continuous Colourmaps	49
Discrete Colourmaps	51
Opacity	53
Property Buttons	54
Legends	54
Slice Mode	54
Filtering Data Using Queries	55
Filtering Data Using Values and Categories	55
Drawing in the Scene	56
The Drawing Toolbar	57
Drawing Hotkeys	58
Drawing 3D Lines	59
Drawing 2D Lines	61
Polyline Properties	62
Tangents and Ribbons	62
Drawing Points	63
Editing Normals	64

Organising Your Workspace	66
Detaching Tabs	66
Detaching and Minimising the Project Tree	67
Organising the Scene View Tab	67
Interpolant Functions	69
The Spheroidal Interpolant Function	69
Total Sill	70
Nugget	71
Nugget to Total Sill Ratio	71
Base Range	71
Alpha	73
Drift	74
Accuracy	75
The Linear Interpolant Function	75
Total Sill and Base Range	77
Nugget	77
Drift	78
Accuracy	78
Central Integration	80
Enabling Central	80
Setting Up the Connection	81
Connecting to Central	82
Viewing a Project's History	83
Locking Branches	84
Project Included	84
Project Stages	85
Annotations and Attachments	85
Sharing Projects	85
Downloading a Local Copy of a Project	86
Publishing to Central	87
Unfinished Publish Events	88
Selecting Objects	88
Setting the Project Workflow Stage	89
Including the Project	89
Adding Revision Information	89
Preparing the Package	89
Uploading the Package	89

New Central Projects	90
Creating a New Central Project	90
Adding a Project to Central	91
Troubleshooting Connectivity Issues	91
Settings	92
Display and Navigation Settings	92
3D Acceleration Mode	92
Font Size	93
Z Axis Scale	93
Rotation Settings	94
Camera Settings	94
Overlay Settings	95
Screen Grid Settings	95
Axis Lines Settings	95
Other Overlay Settings	95
Colour Scheme	95
Lighting Settings	96
Processing Settings	97
User Interface Settings	97
Show Tree Lines	97
Show Save Scene Button	98
Upload to View	98
Tab Position	98
Central Settings	98
Network Settings	100
Help Settings	100
Reporting a Problem	100
Getting Support	101
Checking Connectivity with Leapfrog Start	101
Supplying Your Licence Details	101
Data Types	103
Working with Data Tables	104
Identifying Errors in Data Tables	105
Exporting Data Errors	106
Correcting Data Errors in Leapfrog Geothermal	107
Replacing Values in a Column	108
Common Errors and How to Fix Them	109

Duplicate Points Error (Points Tables)	110
Duplicate Hole ID Error	110
Hole ID Not in Collar Table Error	111
Collar Max Depth Error	111
Invalid Max Depth Error	112
From Depth Exceeds To Depth Error	112
Overlapping Segments Error	113
No Samples for Collars Warning	113
No Surveys for Collar Warning	114
Wedges Found Warning	114
Handling Special Values	114
Boundaries	116
The Clipping Boundary	116
Object Extents	119
Extending a Surface	120
Query Filters	122
Creating a New Query Filter	123
Leapfrog Geothermal Query Syntax	124
Building a Query	125
Advanced Queries	126
Defining a Topography	126
Topography From Elevation Grid	127
Topography From Surfaces, Points or GIS Vector Data	127
Fixed Elevation Topography	128
Adding Height Data to the Topography	128
Changing Topography Settings	129
Changing the Size of the Topography	129
Topography Resolution	130
Applying a Trend to the Topography	130
Topography Display Options	130
Projecting Collars onto the Topography	131
GIS Data, Maps and Images	132
Displaying GIS Data	132
Custom Topography Views	132
Importing Vector Data	134
Importing a MapInfo Batch File	135
Importing Data from an ESRI Geodatabase	136

Reloading GIS Data	137
Reloading Points, Lines and Polygons	137
Reloading an ESRI Database	137
2D Grids	138
Importing a Map or Image	138
Manual Georeferencing	140
Automatic Georeferencing	141
Exporting a Georeferenced Image	141
Setting Elevation for GIS Objects and Images	141
Creating a New GIS Line	142
Drawing a New GIS Line	143
Creating a New GIS Line from Intersecting Meshes	143
Exporting GIS Data	144
Well Data	145
Displaying Wells	146
Displaying Wells as Lines or Cylinders	147
Hiding Lithologies	149
Displaying a Legend	149
Changing Colourmaps	150
Viewing Multiple Interval Tables	150
Selecting from Multiple Columns	150
Displaying Interval Data in the Scene	151
Displaying Well Graphs	152
Viewing Well Data Table Statistics	154
Importing Well Data	154
Expected Well Data Tables and Columns	155
The Collar Table	155
The Survey Table	156
The Screens Table	156
Interval Tables	156
Selecting Files	157
Working Through the Data	158
Selecting the ODBC Data Source	161
Selecting Tables	161
Connecting to an acQuire Database	163
Smart Refresh	164
Saving a Selection	164

Appending Wells	164
Importing Interval Tables	165
Importing Columns	165
Importing Screens	165
Importing Point Values Down Wells	166
Importing LAS Points Down Wells	166
LAS File Mapping	167
LAS File Inconsistencies	167
Importing Downhole Structural Data	167
Well Desurveying Options	168
The Spherical Arc Approximation Algorithm	169
The Balanced Tangent Algorithm	170
The Raw Tangent Algorithm	170
Processing Well Data	171
Category Composites	172
Converting Ignored Segments	173
Filtering Short Segments	175
Viewing Category Composite Statistics	176
Majority Composites	177
Viewing Majority Composite Statistics	179
Numeric Composites	179
Creating a Numeric Composite	180
Selecting the Compositing Region	180
Compositing in the Entire Well	181
Compositing in a Subset of Codes	181
Compositing in Intervals	182
Compositing Parameters	182
Discard	182
Add to Previous Interval	183
Distribute Equally	183
Setting the Sampling Method	183
Selecting Output Columns	184
Selecting Output Algorithms	184
Viewing Numeric Composite Statistics	184
Compositing Comparison	185
Compositing Interval Lengths	186
Numeric Point Upscaling	187

Selecting the Upscaling Region and Upscaling Length	187
Upscaling in the Entire Well	187
Upscaling in a Subset of Codes	188
Upscaling in Intervals	189
Setting the Minimum Points	189
Setting the Sampling Method	189
Selecting Output Columns	189
Selecting Output Algorithms	189
Viewing Upscaled Points Statistics	189
Grouping Lithologies	190
Automatic Lithology Groups	193
Splitting Lithologies	194
Interval Selection	197
Overlaid Lithology Column	200
Category Column from Numeric Data	201
Back-Flagging Well Data	202
Comparing Modelled Values to Drilling Lithologies	203
Comparing Drilling Lithologies to Modelled Values	206
Refining the Geological Model to Improve Correlation Statistics	207
Merged Well Data Tables	207
Core Photo Links	208
The ALS Core Photo Interface	209
Setting Up the ALS Interface	209
Using the ALS Interface	211
Removing the ALS Link	211
The Coreshed Core Photo Interface	211
Setting Up the Coreshed Interface	212
Using the Coreshed Interface	212
Removing the Coreshed Link	213
Reloading Well Data	213
Exporting Well Data	213
Exporting All Well Data	214
Exporting a Single Well Data Table	215
Points Data	216
Importing Points Data	216
Selecting the ODBC Data Source	217
Reloading Points Data	217

Appending Points Data	217
Importing a Column	218
Setting Elevation for Points	218
Evaluating Points Data	218
Displaying Points	219
Viewing Points Table Statistics	220
Exporting Points Data	221
Exporting Intrusion Values	221
Exporting Interval Midpoints	221
Extracting Points from Well Data	222
Extracting Contact Points from Well Data	222
Extracting Intrusion Values from Well Data	224
Intrusion Point Generation Parameters	225
Extracting Interval Midpoints from Well Data	226
Creating Guide Points	226
Grids of Points	227
Creating a Grid of Points	227
Evaluating a Grid of Points	229
Statistics for a Grid of Points	229
Exporting a Grid of Points	229
Categorising Points	230
Geophysical Data	233
Geophysical Points Data	233
3D Geophysical Points	233
ASEG_DFN Files	234
2D Points	234
Visualising Geophysical Point Data	235
Geophysical Grids	235
2D Grids	235
Gocad Models	236
UBC Grids	236
Importing a UBC Grid	236
Evaluating UBC Grids	236
Mapping Category Evaluations	237
Exporting a UBC Grid	237
Magnetotelluric Resistivity Files	237
Exporting Geophysical Grids to CSV	238

Structural Data	239
Creating New Planar Structural Data Tables	239
Importing Planar Structural Data	241
Selecting the ODBC Data Source	242
Importing Lineations	242
Displaying Structural Data	243
Viewing Statistics on Structural Data	246
Bingham Analysis	246
Fisher Statistics	247
Assigning Structural Data to Categories	247
Editing the Orientation of Planar Structural Data	249
Declustering Planar Structural Data	249
Setting Elevation for Structural Data	251
Estimating Planar Structural Data	251
Meshes	251
Cleaning Up a Mesh	252
Importing a Mesh	254
Meshes with Textures	254
Reloading a Mesh	254
Displaying Surfaces	255
Draping an Image on a Mesh	255
Importing Meshes from Central	256
Importing Central Meshes	256
Updating Out-of-Date Meshes	257
Exporting Meshes	257
Exporting a Single Mesh	258
Exporting Multiple Meshes from the Meshes Folder	260
Exporting Multiple Meshes from Models	261
Modifying Surfaces	263
Surface Resolution in Leapfrog Geothermal	263
Adding Data to Surfaces	264
Honouring Surface Contacts	265
Global Trends	268
Structural Trends	270
Creating a Structural Trend	270
Displaying a Structural Trend	272
Applying a Structural Trend	273

Editing Surfaces with Polylines	274
Editing Surfaces with Structural Data	276
Non-Editable Meshes	276
Mesh from the Moving Plane	276
Combining Meshes	277
Clipping a Volume	277
Clipping a Mesh	278
Extracting Mesh Parts	278
Interpolated Meshes	279
Creating an Interpolated Mesh	280
Refining an Interpolated Mesh	280
Surface Resolution Settings	281
Snap Settings	281
Other Options	282
Offset Meshes	282
Triangulated Meshes	284
Mesh From Thickness Values	286
Elevation Grids	286
Importing an Elevation Grid	287
Exporting an Elevation Grid	288
Thickness Grids	288
Polylines	290
Creating Polylines	290
Displaying Polylines	290
Sharing and Unsharing Polylines	291
Importing Polylines	292
Reloading Polylines	293
Exporting Polylines	293
Analysing Data	294
Statistics	294
Table of Statistics	295
Scatter Plots	299
Q-Q Plots	301
Box Plots	302
Univariate Graphs	303
Well Correlation Tool	305
Selecting Collars	305

The Correlation Set Window	307
Navigating in the Correlation Set Window	309
Correlation Column Layouts	309
Managing Styles	310
Interpretation Tables	310
Assigning Lithologies	311
Modifying the Interpretation Table	312
Stereonet	315
Creating a Stereonet	315
Displaying the Stereonet in the 3D Scene	316
Plot Options	317
Data Display Options	317
Viewing Stereonet Statistics	321
Selecting Data in the Stereonet	321
Using the Scene Window with the Stereonet	326
Exporting a Stereonet	326
Form Interpolants	327
Creating a Form Interpolant	327
Setting a Trend	328
Adding Isosurfaces	329
The Form Interpolant in the Project Tree	329
Form Interpolant Statistics	330
Planning Wells	331
Adding Planned Wells	331
Planning Options	332
Drilling Prognoses	332
Exporting Planned Wells	333
Modelling	334
Evaluations	334
Assigning Attributes to Volumes	335
Geological Models	337
Creating a New Geological Model	337
The Base Lithology	337
Surface Resolution	338
Model Extents	338
The Geological Model in the Project Tree	339
Geological Model Display	339

Copying a Geological Model	340
Creating a Static Copy of a Geological Model	340
Geological Model Volumes and Surfaces Export Options	340
Extracting Model Volumes	341
Editing a Geological Model	342
Changing the Query Filter	343
Surface Generation Options	344
Volume Generation Options	345
Surface Resolution for a Geological Model	345
Modifying a Geological Model’s Boundary	346
Creating Extents for a Geological Model	347
Extent From a Polyline	347
Extent From GIS Vector Data	348
Extent From Points	349
Extent From Structural Data	349
Extent From a Surface	351
Extent From Distance to Points	351
Extent From a Distance Function	352
Base From Lithology Contacts	353
Changing an Extent’s Settings	354
Surface Resolution	354
Contact Honouring	355
Applying a Trend	355
Adding Data to an Extent	356
Editing an Extent with a Polyline	356
Editing an Extent with Structural Data	356
Removing an Extent from a Geological Model	357
Model Lithologies	358
Faulted Models	359
The Fault System	360
Fault Interactions	361
Activating the Fault System	362
Copying the Surface Chronology to an Empty Fault Block	362
Faulted Model Display Options	363
Editing Faults	363
Surfacing Options for Faults	363
Boundary Filtering	364

Snapping to Data	364
Changing Fault Inputs	365
Replacing Fault Inputs with a Single Mesh	365
Adding Data to the Fault	366
Snap Settings for Individual Inputs	366
Boundary Filtering Settings for Individual Inputs	366
Applying a Trend to a Fault	366
Contact Surfaces	367
Contact Surfaces in the Surface Chronology	367
Contact Surfaces Types	370
Deposit and Erosion Contact Surfaces	371
Intrusion Contact Surfaces	372
Vein Contact Surfaces	374
Younging Direction	375
Deposits and Erosions	375
Creating Deposits and Erosions	376
Deposits and Erosions From the Base Lithology	376
Deposits and Erosions From Other Lithology Contacts	379
Deposits and Erosions From Other Data	380
Deposits/Erosions in the Project Tree	382
Refining Deposits and Erosions	382
Surfacing Options for Deposits and Erosions	383
Boundary Filtering	383
Snapping to Data	383
Setting the Surface Resolution	384
Applying a Trend to a Deposit/Erosion	384
Intrusions	384
Creating Intrusions	385
Intrusions from Lithology Contacts	385
Intrusions from Other Data	386
Intrusions in the Project Tree	388
Displaying Intrusion Points	388
Refining Intrusions	389
Surfacing Options for Intrusions	389
Boundary Filtering	389
Snapping to Data	390
Surface Resolution	390

Applying a Trend to an Intrusion	391
Clipping Values for Intrusions	392
Interpolation Settings	392
Veins	393
Creating Veins	393
Veins From Lithology Contacts	393
Veins From Other Data	394
Veins in the Project Tree	395
Displaying Veins	396
Refining Veins	396
Surfacing Options for Veins	396
Boundary Filtering	396
Snapping to Data	397
Surface Resolution	397
Vein Thickness	397
Vein Pinch Out	398
The Vein Reference Surface	399
Adding Data to the Reference Surface	400
Using a Planar Reference Surface	401
The Vein Boundary	401
Adding a Polyline to the Vein Boundary	402
Adjusting the Vein Boundary Plane	402
Editing Vein Segments	403
Vein Segment Orientation	403
Vein Systems	403
Creating a Vein System	405
Adding Veins to the Vein System	405
Editing the Veins	405
Changing Vein System Lithology Settings	405
Setting Vein Interactions	406
Stratigraphic Sequences	408
Creating a Stratigraphic Sequence	409
Boundary Filtering	411
Snapping to Data	411
Surface Stiffness	412
Editing the Stratigraphic Sequence	412
Correcting Pinch-Out Errors	412

Surfacing Options	413
Applying a Trend	413
Editing Individual Surfaces	413
Contact Honouring and Boundary Filtering for Individual Surfaces	414
Adding Data to Individual Surfaces	414
Editing Surface Contacts	414
Offset Surfaces	414
Creating an Offset Surface	416
The Offset Surface in the Project Tree	417
Refining an Offset Surface	417
Changing Surfacing Options for an Offset Surface	417
Boundary Filtering	418
Snapping to Data	418
Surface Resolution	419
Smoothing	419
Changing Offset Limits	419
Changing to a Constant Offset	419
Changing to an Offset to Points	420
Changing the Reference Mesh	420
Editing the Reference Mesh	420
Structural Surfaces	420
Creating a Structural Surface	421
The Structural Surface in the Project Tree	422
Refining a Structural Surface	422
Surfacing Options for a Structural Surface	423
Setting the Surface Resolution	423
Boundary Filtering	423
Snapping to Input Data	423
Non-Contact Structural Inputs Settings	424
Applying a Trend to a Structural Surface	424
Value Clipping	425
The Surface Chronology	425
Refined Lithological Volumes	426
Editing the Sub-Model	428
Numeric Models	430
Importing a Variogram Model	431
Copying a Numeric Model	431

Creating a Static Copy of a Numeric Model	431
Exporting Numeric Model Volumes and Surfaces	432
Exporting Numeric Model Midpoints	432
RBF Interpolants	432
Creating an RBF Interpolant	433
Values Used	433
Applying a Query Filter	434
Applying a Surface Filter	434
The Interpolant Boundary	434
Compositing Options	434
General Interpolant Properties	435
The RBF Interpolant in the Project Tree	435
Interpolant Display	436
RBF Interpolant Statistics	436
Modifying an RBF Interpolant's Boundary with Lateral Extents	436
Creating Lateral Extents	437
Extent from a Polyline	437
Extent from GIS Vector Data	438
Extent from Points	439
Extent from Structural Data	439
Extent from a Surface	440
Extent from Distance to Points	440
Extent from a Distance Function	441
Changing a Lateral Extent's Settings	442
Surface Resolution	442
Contact Honouring	442
Applying a Trend	443
Adding Data to an Extent	444
Editing an Extent with a Polyline	444
Editing an Extent with Structural Data	444
Removing an Extent from an Interpolant	444
Changing the Settings for an RBF Interpolant	445
Adjusting the Values Used	445
Adding a Contour Polyline	446
Adding Points	447
Compositing Parameters for an RBF Interpolant	447
Adjusting the Interpolant Boundary	448

Clipping and Transforming Values for an RBF Interpolant	449
Changing the Trend for an RBF Interpolant	450
Using a Global Trend	450
Using a Structural Trend	451
Adjusting Interpolation Parameters	453
Output Settings for an RBF Interpolant	454
Multi-Domained RBF Interpolants	454
Creating a Multi-Domained RBF Interpolant	455
Compositing and Filtering the Values Used	456
Selecting Domains	457
Clipping and Transforming Values	457
Setting the Trend	457
Interpolation Parameters	457
Output Options	457
The Multi-Domained RBF Interpolant in the Project Tree	459
Interpolant and Sub-Interpolant Display	459
Sub-Interpolant Statistics	460
Indicator RBF Interpolants	460
Creating an Indicator RBF Interpolant	461
Selecting the Values Used	461
Setting the Cut Off	461
Applying a Query Filter	462
Applying a Surface Filter	462
The Interpolant Boundary	462
Compositing Options	462
General Interpolant Properties	463
The Indicator RBF Interpolant in the Project Tree	463
Indicator RBF Interpolant Display	464
Indicator RBF Interpolant Statistics	465
Editing an Indicator RBF Interpolant	465
Adjusting the Values Used	466
Adding a Contour Polyline	466
Adding Points	468
Compositing Parameters for an Indicator RBF Interpolant	469
Adjusting the Interpolant Boundary	470
The Cut-Off Value	471
Changing the Trend for an Indicator RBF Interpolant	471

Adjusting Interpolation Parameters	472
Indicator RBF Interpolant Surfacing and Volume Options	473
Distance Functions	474
Creating a Distance Function	474
Setting the Boundary	476
Setting a Trend	476
Adding Buffers	477
The New Distance Function in the Project Tree	477
Inverse Distance Weighted (IDW) Grid Interpolants	478
Creating an IDW Interpolant	478
Values Used	479
IDW Parameters	479
The Interpolant Boundary	479
General Interpolant Properties	479
The IDW Interpolant in the Project Tree	480
Interpolant Display	480
IDW Interpolant Statistics	481
Modifying an IDW Interpolant’s Boundary with Lateral Extents	481
Changing the Settings for an IDW Interpolant	482
Adjusting the Interpolant Boundary	482
Clipping and Transforming Values for an IDW Interpolant	483
Output Settings for an IDW Interpolant	484
Combined Models	485
Creating a Combined Model	485
The Combined Model in the Project Tree	486
Editing a Combined Model	487
Displaying a Combined Model	487
Creating a Static Copy of a Combined Model	487
Combined Model Export	487
Flow Models	488
MODFLOW Models	488
Creating a MODFLOW Model	488
Horizontal Grid Spacing	490
Vertical Grid Layering	491
Editing a MODFLOW Model	493
Importing a MODFLOW Model	495
MODFLOW Evaluations	496

Assigning an Evaluation for Export	496
Combined Evaluations	496
MODFLOW Hydrological Properties	497
Setting Hydrological Properties	498
Zone Numbers	500
MODFLOW Model Display	500
Grid Display Options	501
Viewing Block Information	502
Head Values and MT3D Concentrations	502
Generating a Head Value Mesh	503
MODFLOW Model Export	503
As a MODFLOW File	503
For Groundwater Vistas	503
As a Groundwater Vistas Update	504
FEFLOW Models	504
FEFLOW Model Display	505
Displaying a 3D Model	506
Displaying a 2D Model	507
Viewing Block Information	508
Importing a FEFLOW Grid	508
Creating a 2D FEFLOW Model	509
Boundary Options	510
Element Size	511
Adding Features to the Grid	511
Creating a 3D FEFLOW Model	513
FEFLOW Evaluations	515
Assigning an Evaluation for Export	515
Combined Evaluations	516
FEFLOW Material Types	516
FEFLOW Model Export	518
TOUGH2 Models	519
Structured TOUGH2 Models	519
Unstructured TOUGH2 Models	521
Importing TOUGH2 Models	525
Loading TOUGH2 Outputs	526
Loading TOUGH2 Inputs	526
Generating Rocktypes	527

Displaying TOUGH2 Models	528
Editing TOUGH2 Grid Parameters	529
TOUGH2 Parameters	530
TOUGH2 Boundary Conditions	531
TOUGH2 Generators	531
Editing Rock Type Properties	533
Evaluating a Faulted Model	533
Copying a TOUGH2 Model	535
Creating a Static Copy of a TOUGH2 Model	535
Exporting TOUGH2 Models	535
Exporting Block Lithologies	535
Exporting TOUGH2 Inputs	536
TETRAD Models	536
Importing a TETRAD Model	536
Loading Simulation Outputs	537
Displaying the Model	538
Exporting the Model	538
Block Models	539
Importing a Block Model	539
Importing an Isatis Block Model	539
Importing a Block Model in CSV Format	540
Creating a Block Model	541
Displaying a Block Model	542
Viewing Block Model Statistics	543
Exporting Block Models	543
Exporting Block Models in CSV Format	544
Selecting From Evaluated Items	544
Setting Row Filtering Options	545
Setting Numeric Precision	545
Setting Status Code Text Sequences	545
Selecting the Character Set	545
Exporting Block Models in Isatis Format	545
Selecting From Evaluated Items	546
Setting Status Code Text Sequences	546
Selecting the Character Set	546
Exporting Block Models in Datamine Format	546
Selecting From Evaluated Items	546

Setting Row Filtering Options	546
Setting Status Code Text Sequences	547
Selecting the Character Set	547
Renaming Items	547
Exporting Block Models in Surpac Format	547
Selecting From Evaluated Items	548
Setting Row Filtering Options	548
Setting Numeric Precision	548
Setting Status Code Text Sequences	548
Selecting the Character Set	548
Sub-Blocked Models	549
Creating a Sub-Blocked Model	549
Model Extents and Rotation	549
The Grid Pattern	550
Triggers and Evaluations	550
Sub-Blocked Model Statistics	550
Sub-Blocked Model Export	551
Exporting Sub-Blocked Models in CSV Format	551
Selecting From Evaluated Items	552
Setting Row Filtering Options	552
Setting Numeric Precision	552
Setting Status Code Text Sequences	552
Selecting the Character Set	552
Exporting Sub-Blocked Models in Datamine Format	553
Selecting From Evaluated Items	553
Setting Row Filtering Options	553
Setting Status Code Text Sequences	553
Selecting the Character Set	553
Renaming Items	553
Presentation	555
Uploading to View	555
Signing in to View	558
Uploading to View	559
Uploading the 3D View	559
Uploading Saved Scenes	560
Troubleshooting Connectivity Issues	560
Sections	561

Evaluating on Sections	561
Exporting Sections	561
Exporting Section Layouts	562
Creating Cross Sections	563
Importing Cross Sections	565
Fence Sections	566
Serial Sections	567
Setting the Base Section	567
Setting the Offset Sections	568
The Serial Section in the Project Tree	569
Displaying a Serial Section	569
Exporting a Serial Section	570
Section Layouts	571
Setting Up the Section	572
Creating New Section Layouts	573
Copying Section Layouts	574
Working With the Section Layout Editor	575
Changing Page Properties	576
Changing the Basic Section Properties	577
Organising Objects on the Section	581
Adding and Styling Models	582
Adding Styling Wells and Planned Wells	589
Adding and Styling Surfaces	593
Adding and Styling Lines	594
Setting Up the Legend	595
Adding and Organising Annotations	599
Displaying a Title	600
Displaying a Title Block	601
Displaying a Scale Bar and Location Information	602
Text Boxes	604
Images	605
Rendered Images	606
Background Rendering	608
Saved Scenes	608
Saving Scenes	609
Exporting Scenes	609
Exporting Scenes for Leapfrog Aspect	610

Linking to Scene Files	611
Movies	611
Contour Lines	613
Creating Contour Lines	613
Exporting GIS Contours	613

Getting Started

Once Leapfrog Geothermal is installed, there are some first steps to carry out before you begin working with projects. This topic describes those first steps—how to license Leapfrog Geothermal and set up your computer's graphics environment—then provides an overview of Leapfrog Geothermal project files. This topic is divided into:

- [Licensing Leapfrog Geothermal](#)
- [Signing in to My Leapfrog](#)
- [Graphics and Drivers](#)
- [The Leapfrog Geothermal Projects Tab](#)
- [Managing Leapfrog Geothermal Projects](#)

Once you have carried out these first steps, see [An Overview of Leapfrog Geothermal](#) for a brief description of the different parts of the Leapfrog Geothermal main window. For more detailed information on using the controls in the different parts of the main window, see the following topics:

- [The Project Tree](#)
- [The 3D Scene](#)
- [Visualising Data](#)
- [Drawing in the Scene](#)
- [Organising Your Workspace](#)

Licensing Leapfrog Geothermal

To run Leapfrog Geothermal, you need a licence. There are two types, one that requires a Leapfrog USB dongle and one that requires the entry of a code.

Dongle Licences

If you have a USB dongle and need to activate your licence, plug the dongle in to your computer and start Leapfrog Geothermal. Leapfrog Geothermal will check the dongle and prompt you to start the activation process. Follow the instructions that appear on the screen.

If the licence cannot be installed, contact Customer Support as described in [Getting Support](#).

If you have an OnDemand licence, you will be prompted to check out days. In the window that appears, the bar shows the maximum checkout period, divided into blocks that each represent one day. Green blocks are active days remaining on your licence, and blue blocks are days available for checkout. Click blue blocks to select additional days; the blocks will turn orange to indicate the additional days you will be checking out.

Click **Get Licence** to update your licence and check out the days indicated in orange.

2 | User Manual

Once Leapfrog Geothermal is running, you can check out additional days by selecting **Extend Licence** from the **Leapfrog Geothermal** menu or by clicking on the button at the bottom of the main window:



Once the licence has been activated, the licence details will be displayed.

Code Licences

You may have a licence that requires the entry of a code. Start Leapfrog Geothermal and click **Enter Licence Code** in the window that appears. Enter the code you have been given and click **Get Started**.

You can copy the licence code from the email or document you received and paste it into the first **Licence Code** field.

If the code cannot be validated and you are sure you have entered the code correctly, contact Customer Support as described in [Getting Support](#).

Signing in to My Leapfrog

The **User Identity** menu in the upper right-hand corner of the main window is used to sign in to My Leapfrog.

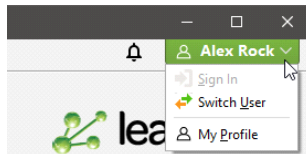

Signing in also signs you in to View, so you can upload scenes to View. The **My Profile** option takes you to My Leapfrog.

Graphics and Drivers

Many laptop computers come with two graphics options: low-powered graphics integrated into the CPU and a high-performance dedicated graphics option (a GPU). To save power, often the laptop's default setting is to run programs using the slower integrated graphics option. However, selecting high-performance graphics options is very important to Leapfrog's performance. If you have a dedicated graphics option, you should be using it. It's also important to have the most up-to-date drivers to make the most of your computer's capabilities.

To determine what graphics capabilities your computer has:

1. From the **Leapfrog Geothermal** menu, select **About**.
2. Click on the **System Info** tab.

Under the **Summary**, you will see the following details:

- **Graphics in use by** shows the graphics option being used. Note that Leapfrog Geothermal uses only the option indicated; if there are two options available, Leapfrog Geothermal does not use both simultaneously.
- **All available graphics hardware** lists the options available. If there are two options listed, you will want Leapfrog Geothermal to use the dedicated graphics option rather than the slower integrated graphics.
- **Driver date** shows the date at which the driver was last updated for each graphics option.

If your graphics drivers are out of date, it is recommended that they be updated prior to switching the graphics in use by Leapfrog Geothermal. To find more information:

- See the [Advanced Troubleshooting Guides](#) on the Leapfrog3D website for more information on how to update drivers for different types of dedicated graphics cards.
- Visit the My Leapfrog forums at <https://forum.leapfrog3d.com/c/open-forum> and search for "graphics".
- Contact technical support as described in [Getting Support](#).

Switching to High-Performance Graphics

If you have more than one graphics option available, ensure you are using the dedicated graphics capabilities to get the most out of Leapfrog Geothermal. The steps below apply to an NVIDIA driver and may be slightly different for other brands. Instructions for other brands can be found on the driver's or laptop manufacturer's website.

The first step is to open the NVIDIA Control Panel.

1. Right-click anywhere on your computer's desktop and select **NVIDIA Control Panel**.

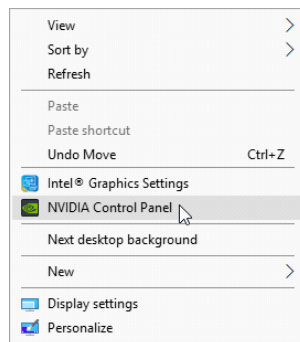

2. Click on **Manage 3D Settings**.

4 | User Manual

3. Click on the **Program Settings** tab.

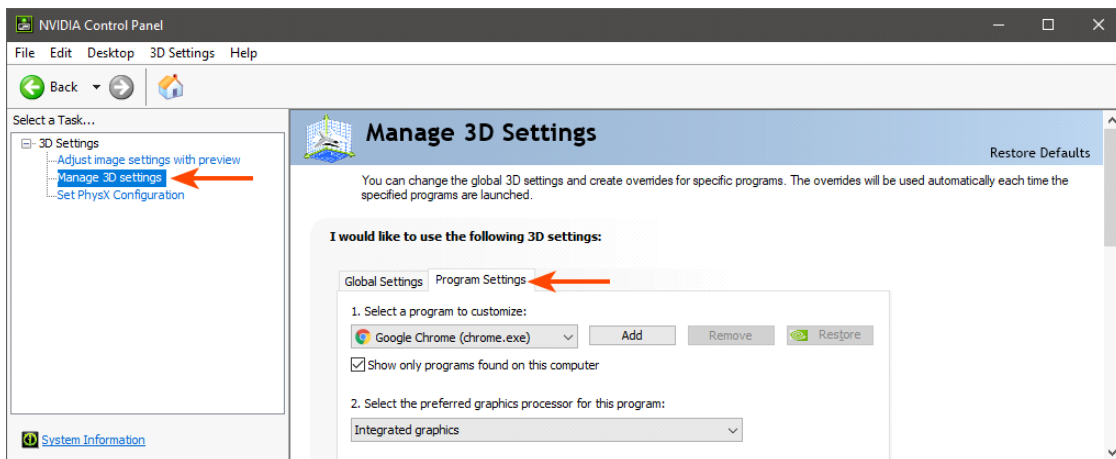

4. Under **1. Select a program to customise**, click the **Add** button.

5. Browse to the location of the Leapfrog Geothermal .exe file.

The default installation location is: C:\Program Files\Seequent\Leapfrog Geothermal3.8\bin\Geothermal.exe.

6. Once selected, click **Open**.

7. Under **2. Select the preferred graphics processor for this program**, select the **High-performance NVIDIA processor**.

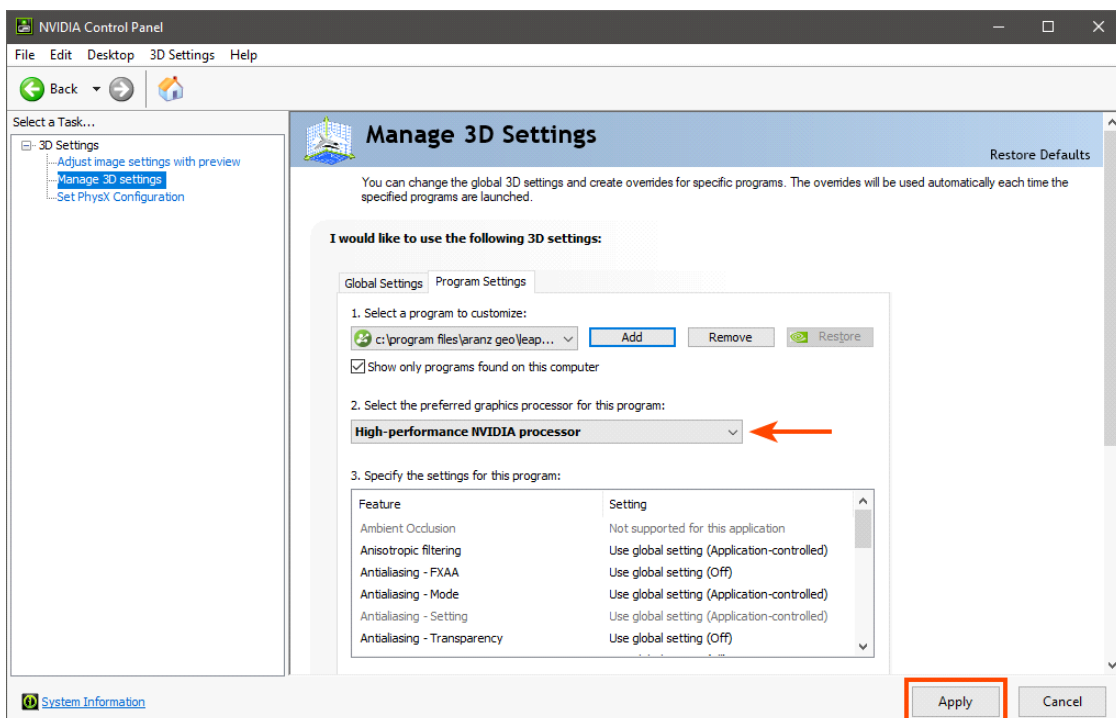

8. Click **Apply**.

On occasion, the graphics switch will be unsuccessful if the dedicated graphics card has old drivers. To ensure a successful switch, update your drivers before switching to your

dedicated graphics card.

Once the drivers are updated and you have switched the in-use graphics card to your dedicated card, verify these changes have been successfully made.

9. Open the **System Info** window.

10. Check that the higher-powered NVIDIA card is now being used and that the drivers show the latest versions.

Running the Graphics Test

Leapfrog Geothermal can run in one of three acceleration modes. These modes are selected by clicking on the button at the bottom of the main window:



See [3D Acceleration Mode](#) in [Settings](#) for more information on these settings.

A newer computer will run in **Full Acceleration** mode without issues. However, if you are running Leapfrog Geothermal on a computer that is more than five years old, it is a good idea to run the graphics test to test your computer's graphics capabilities.

To start the test, open Leapfrog Geothermal and select **Test Graphics** from the **Leapfrog Geothermal > Diagnostics** menu:

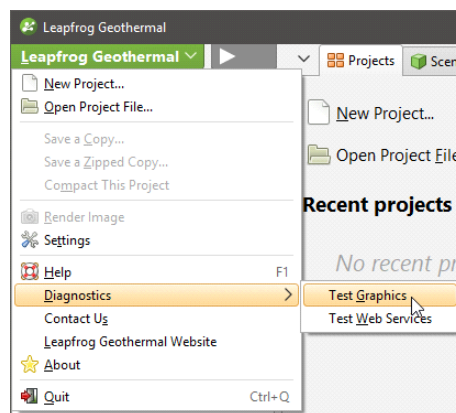

6 | User Manual

The graphics test displays a series of image pairs that test your computer's capabilities for the currently selected acceleration mode. For each pair, compare the images:

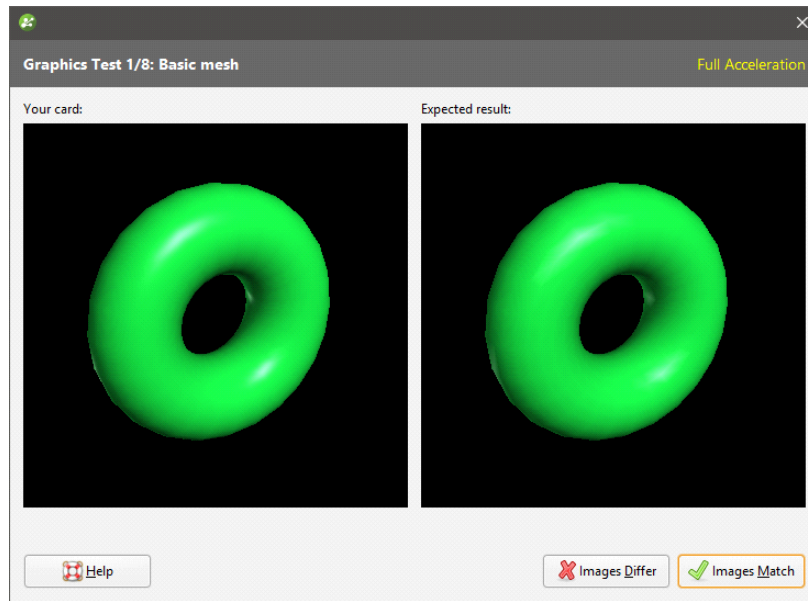

Even if the differences are slight, click the **Images Differ** button. If the images match, click the **Images Match** button. The next test will be displayed.

At the conclusion of the test, the result is displayed. If one or more tests have failed, information about solving problems will be displayed.

If you click on **Save Report**, you will be prompted to save the file on your computer.

If the test has failed, try switching to a different acceleration mode and running the test again. If possible, avoid using **Software Rendering** as it can be very slow.

If you cannot resolve the problem, save a copy of the graphics test report and contact technical support as described in [Getting Support](#). Be sure to include information about your system copied from the **About > System Info** tab.

The Leapfrog Geothermal Projects Tab

When you launch Leapfrog Geothermal, the main window will appear with the **Projects** tab displayed:

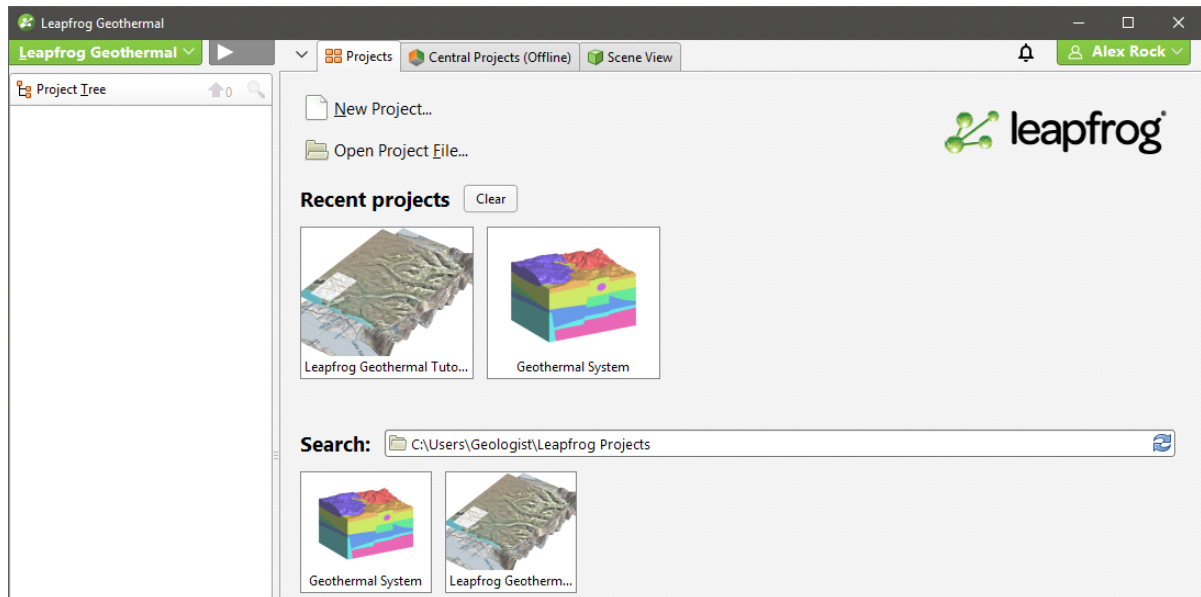

Thumbnails for the most recent projects are displayed in the **Recent projects** list. The second set of thumbnails is for projects contained in the **Search** folder:

- Click on the folder button (📁) or press the F5 key to change the **Search** folder. The **Search** folder is useful if you have one folder in which you keep most of your Leapfrog Geothermal projects.
- Click on the **Refresh** button (🔄) or press the F4 key to update the list of projects in the **Search** folder.

Leapfrog Geo projects are indicated in the **Projects** tab. See [Converting Leapfrog Geo Projects](#) for more information.

Click on a thumbnail to open a project. You can also navigate directly to the required project file by clicking on **Open Project File**.

Once a project file has been opened, Leapfrog Geothermal switches to displaying the **Scene View** tab.

See [Managing Leapfrog Geothermal Projects](#) below for more information on saving, compacting and upgrading projects.

Managing Leapfrog Geothermal Projects

If you and your team need to share projects, see <http://www.leapfrog3d.com/products/leapfrog-central> for information about Central, which is a model management system that lets groups of Leapfrog users share projects. See the [Central Integration](#) topic for more information on how Central and Leapfrog Geothermal work together.

To create a new project, click **New Project** at the top of the **Projects** tab. The new project will be saved in the **Search** folder.

Leapfrog Geothermal project files use the extension **.aproj**. A folder is also created that contains information used by the project.

Do not change the name of your project folder or alter its contents. Doing so could render your project file unusable.

A **.lock** file is created when a project is opened. The **.lock** file protects the project from being moved while the project is open and from being opened by another instance of Leapfrog Geothermal, which can happen when projects are saved on shared network drives.

If processing and display of objects in your project is too slow and your project is stored on a network drive or on a USB drive, consider moving your project onto a local drive. Leapfrog Geothermal is optimised for working off your local hard drive, and working from network drives and USB drives risks corrupting the project.

Saving Projects

Leapfrog Geothermal automatically saves an open project each time a processing task has been completed or settings have changed. Projects are also saved when they are closed so that scene settings can be restored when the project is next opened.

Saving Zipped Copies of Projects

You can save a zipped copy of a project by selecting **Save A Zipped Copy** from the **Leapfrog Geothermal** menu. You will be prompted to choose a name and location for the zipped project. Click **Save** to create the zip file.

Saving Backup Copies of Projects

You can save a backup copy of a project by selecting **Save A Copy** from the **Leapfrog Geothermal** menu. You will be prompted to choose a new name and location for the saved project. Click **OK** to create the new project file. Leapfrog Geothermal will save a copy of the project in the location selected.

Once the backup copy is saved, you can open and use it from the **Projects** tab. Otherwise, you can keep working in the original copy of the project.

Compacting Projects

When you delete objects from a project file, Leapfrog Geothermal retains those objects but notes that they are no longer used. Over time, the project file will grow in size and data stored in the database may become fragmented.

Compacting a project removes these unused objects and any unused space from the database. When you compact a project, Leapfrog Geothermal will close the project and back it up before compacting it. Depending on the size of the project, compacting it may take several minutes. Leapfrog Geothermal will then reopen the project.

To compact a project, select **Compact This Project** from the **Leapfrog Geothermal** menu. You will be asked to confirm your choice.

Upgrading Projects

When you open a project that was last saved in an earlier version of Leapfrog Geothermal, you may be prompted to upgrade the project. A list of affected objects will be displayed. For large projects with many objects that need to be reprocessed, the upgrade process may take some time.

It is a good idea to back up the project before opening it. Tick the **Back up the project before upgrading** button, then click **Upgrade and Open**. Navigate to the folder in which to save the backup and click **Save**.

For large projects with many objects, upgrading without backing up the project is not recommended.

Converting Leapfrog Geo Projects

Leapfrog Geo projects can be converted to Leapfrog Geothermal projects. However, the process is one-way, and projects opened in Leapfrog Geothermal can no longer be opened in Leapfrog Geo.

When you open a Leapfrog Geo project, you will be prompted to save a backup before converting the project.

It is strongly recommended that you back up the project before converting it.

What is Implicit Modelling?

Implicit modelling is a game-changing innovation in geological modelling.

Traditionally, geological models are produced using a manual drawing process. Sections are defined, and lithologies, faults and veins are drawn on the sections. Lines are then drawn to connect surfaces across multiple sections. Modelling geology in this manner is time-consuming and inflexible as it is difficult to update the model when more data becomes available. Early assumptions that later are proved incorrect could shape a model in a way that is never corrected because of the effort involved in starting over. Instead of using their knowledge to reveal important information about the study site, geologists spend significant proportions of their time engaged in mechanical drawing.

Implicit modelling, on the other hand, allows geologists to spend more time thinking about the geology. Implicit modelling eliminates the laborious legwork by using mathematical tools to derive the model from the data. A mathematical construct is built that can be used to visualise different aspects of the data in 3D. Leapfrog Geothermal uses FastRBF™, a mathematical algorithm developed from radial basis functions. FastRBF uses the data and parameters supplied by the geologist to derive any one of a number of variables to be modelled. Discrete variables such as lithologies can be used to construct surfaces, as well as continuous variables such as ore grades.

Instead of presenting a model constructed from rigid geometric constructs, the visualisations echo the natural forms found in reality.

What are the Advantages of Implicit Modelling?

Implicit models are easy to keep up-to-date with the latest data. New well data can quickly be integrated, instead of taking weeks or longer manually modifying the model.

Implicit modelling allows several alternative hypothetical models to be produced from the data, quickly and easily. New data that affects the model, even in very significant or fundamental ways, can be assimilated and integrated with little effort. Models can be built rapidly, which means that a range of geological interpretations can be continually tested.

Because less effort is involved in creating a model, more time is available to spend on understanding the geology and studying more complex details such as faulting, stratigraphic sequences, trends and veins. The model can be developed to reflect reality to a greater degree of precision than was previously possible.

Geological risk is reduced when modelling is done implicitly. With traditional modelling, the effort involved means that the first model developed may be held to as the ground truth, despite mounting evidence that may discredit it. Instead, implicit modelling supports an approach that follows the proven scientific method, developing hypothetical models, experimenting to find new data to corroborate or discredit models and, ultimately, allowing the best model to be revealed. A geologist can experiment with alternative parameters at the limits of what is geologically reasonable to determine if there is any significant variation in the resulting models, which can then bracket the model with conceptual error bars. Geostatistical analysis can be conducted to identify what models are the most valid.

It is easy to change your mind when modelling implicitly. Perhaps models have been produced demonstrating isometric shells enclosing specific grades of ore. Commodity price changes then make it desirable to recreate the model using alternative ore grade values. If the model had been produced manually, doing so would not be practical. But with implicit modelling, the ease of generating a new model with new interpolation parameters means this valuable business information can be readily produced.

New questions can be answered more easily. A model tends to answer one question or class of questions well, and new questions require new models. If a model takes months to produce, those new questions may remain forever unanswered. If it can be produced with only days or hours worth of effort, valuable insights can be gained that could provide critical business value.

Implicit Modelling Makes Assumptions Explicit

Often, there is insufficient information in the data alone. For instance, well data may well need to be supplemented with known details about the geology. When a geologist is constructing a model using traditional techniques, they use their knowledge of the geology to make decisions about the model as it is constructed. This is something the geologist will do automatically, which irretrievably conflates measured data with hypothesised data, hiding away subjective assumptions that have influenced the development of the model.

Implicit modelling, however, keeps the measured data separate from interpretations. The geologist can use polylines and structural disks to interpret the data without equating them to measured data. Implicit modelling makes assumptions explicit; there is a clear separation between hard data and user-introduced interpretations.

Implicit modelling and the presentation of a selection of models communicating different aspects of the geology provide new tools a geologist can use to communicate with professionals in other parts of the business.

On a purely business level, specialist staff can be putting their skills to use in productive, valuable geological modelling, rather than drawing lines on sections ad infinitum.

Implicit models are more repeatable and, therefore, more auditable, because they are derived from actual data and explicitly communicated geological interpretations, with selected parametric variables as inputs and processed using a mathematical algorithm.

The only thing implied in implicit modelling is the unknown value between two known values. Everything else is explicit. For this reason, it is best to refer to traditional modelling techniques as 'traditional modelling' rather than 'explicit modelling', assuming that it should be labelled with a name that is the inverse of 'implicit modelling'. Implicit modelling is much more explicit than traditional modelling.

Best Practices

- **Analyse data.** Analyse your data using well interpretation and data visualisation tools. Use 3D visualisation to look for errors in the data set.
- **Stay focussed.** Produce a model that answers a specific question or addresses a specific problem. Don't unnecessarily model all the data available just because it is there. When a new question is asked, produce a model that answers that question using the necessary data.

- **Experiment and explore.** Produce variations of the same model, or even models, using quite different fundamental assumptions. Plan wells that will help reveal what model fits best and then discard models that are inconsistent with new data.
- **Understand risk.** Model using a range of input parameters and assumptions to understand the level of geologic risk.
- **Share.** Discuss and explore alternatives.
- **Adapt.** Previously, the effort of production and review of traditional models meant that there is reluctance to rebuild a model when new data becomes available soon after model completion. However, with implicit modelling, you should integrate new data and refine the model as soon as the new data is available. The revised model could indicate that planned activities should be redirected as expensive resources would be wasted persisting with the original plan, for little return.
- **Evaluate and review.** Don't assume that because it's easy to generate a model that you have quickly produced the right model. Understanding the geology is vital for validating the model and producing something that is geologically reasonable.

An Overview of Leapfrog Geothermal

This topic provides an overview of the different parts of the Leapfrog Geothermal main window. For more detailed information on using the controls in the different parts of the main window, see the following topics:

- [The Project Tree](#)
- [The 3D Scene](#)
- [Visualising Data](#)
- [Drawing in the Scene](#)
- [Organising Your Workspace](#)

If you are new to Leapfrog Geothermal, it is a good idea to go through the tutorials, which introduce basic concepts. The tutorials take two to four hours to complete and will get you to the point where you can start processing your own data. To download the tutorials, visit <http://help.leapfrog3d.com/Geothermal/3.8/en-GB/Content/tutorials.htm>.

The Leapfrog Geothermal main window is divided into three main parts:

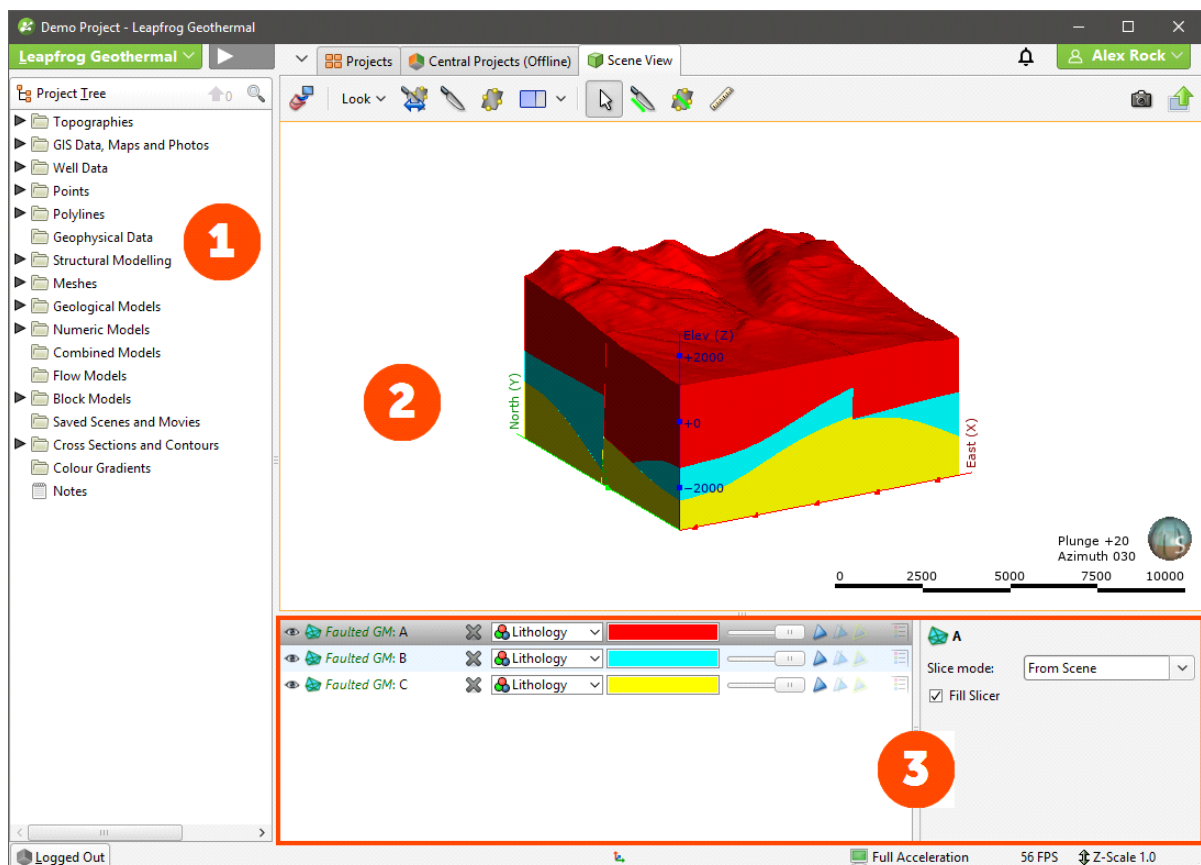

1

The **Project Tree** contains all the data in the project and tools for working with that data. When you want to change how this data is used in the project, work with the objects in the project tree. See [The Project Tree](#).

2	The Scene View tab displays a 3D representation of selected objects from the project tree. Changing how you view objects in the scene window does not change those objects in the project tree. See The 3D Scene .
3	Tools for changing the appearance of data in the scene window are available in the shape list and the shape properties panel. Changing the appearance of these objects does not change those objects in the project tree. See Visualising Data .

You can add objects to the scene window by dragging them from the project tree. You can temporarily hide them in the scene or remove them altogether using the controls in the shape list.





Leapfrog Geothermal is unit-less and adopts the units used in the data you import. For example, if your imported data is in metres, the units displayed will be metres, and figures such as resolution, measured distances and slicer thickness will be in metres. It is important, therefore, to be consistent in the units used in the data you import. If you are importing data that uses different coordinate systems, you will need to pre-process the data so that it is using the same coordinate system.

When you open a Leapfrog Geothermal project, the project is displayed in the state it was in when it was closed.

Keyboard Shortcuts in the Main Window

Use the Tab and Shift+Tab keys to move between the different parts of the main window in the following order:

- Project tree
- Scene toolbar
- Scene window
- Shape list
- Shape properties panel

Key(s)	Action
F8	Maximise scene, minimise project tree and shape list. Press F8 again to restore.
Ctrl+1	Activate the Select tool 
Ctrl+2	Activate the Draw slicer line tool 
Ctrl+3	Activate the Draw plane line tool 
Ctrl+4	Activate the Ruler tool 
F10 or Alt L	Open the Leapfrog Geothermal menu
F1	Open Leapfrog Geothermal help
Ctrl+Q	Quit Leapfrog Geothermal

The Project Tree

The series of folders in the project tree are used to organise objects such as datasets, maps and images into categories. These folders also provide tools that let you import information into the project and generate models. Right-click on each folder to view the actions you can perform using that folder.

This topic provides an introduction to working with the project tree. It is divided into:

- [Organising Objects in the Project Tree](#)
- [Object Properties](#)
- [Comments](#)
- [Processing Tasks](#)
- [Project Tree Keyboard Shortcuts](#)

You can also right-click on objects within the top-level folders to view more information on that object or carry out actions specific to that object. For example, right-clicking on a table of imported well data reveals a menu showing possible actions:

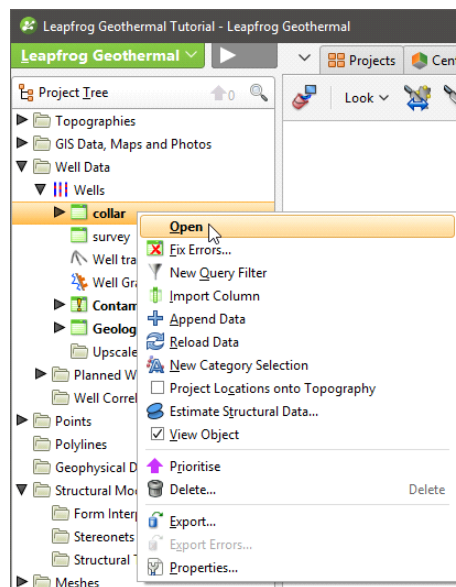

When a bold option appears in the right-click menu, as **Open** does in the menu above, that option can also be selected by double-clicking on the object.

You can select more than one object in the project tree by holding down the Shift key or the Ctrl key while clicking. This is useful for viewing or deleting multiple objects at once.

The way folders and objects are organised in the project tree lets you reveal or hide information about an object to focus on objects you are currently working with. This is also useful when you are exploring a project and want to determine how something was put together. The arrows next to objects in the project tree let you reveal or hide an object's details to focus on objects you are currently working with. Here, the **Topographies** folder is expanded to show a **Topography** object that is made up of a mesh:

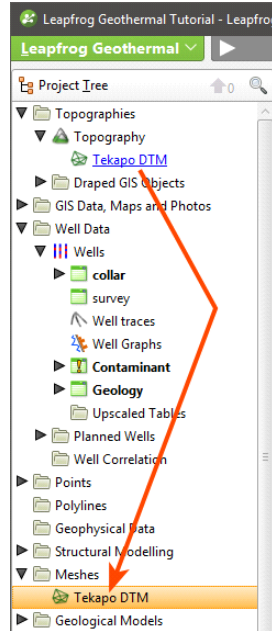

Also note that:

- The mesh itself is stored in the **Meshes** folder, but is hyperlinked to from wherever it is used in the project.
- The **Well Data** folder and the **Wells** object have been expanded to show the well data tables.
- Folders that have no arrow have no detail stored.

Expanding a data table (📄) shows the columns in that table contains, including category data columns (📄), numeric data columns (📊) and query filters (🔍):

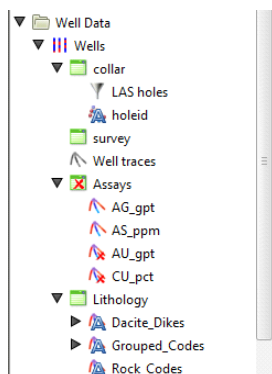

Some tables are marked as having errors (🚫), which are discussed in [Identifying Errors in Data Tables](#).

Expanding a geological model reveals information about how it was built. Here, a geological model has been expanded to show the basic objects that make up a model:

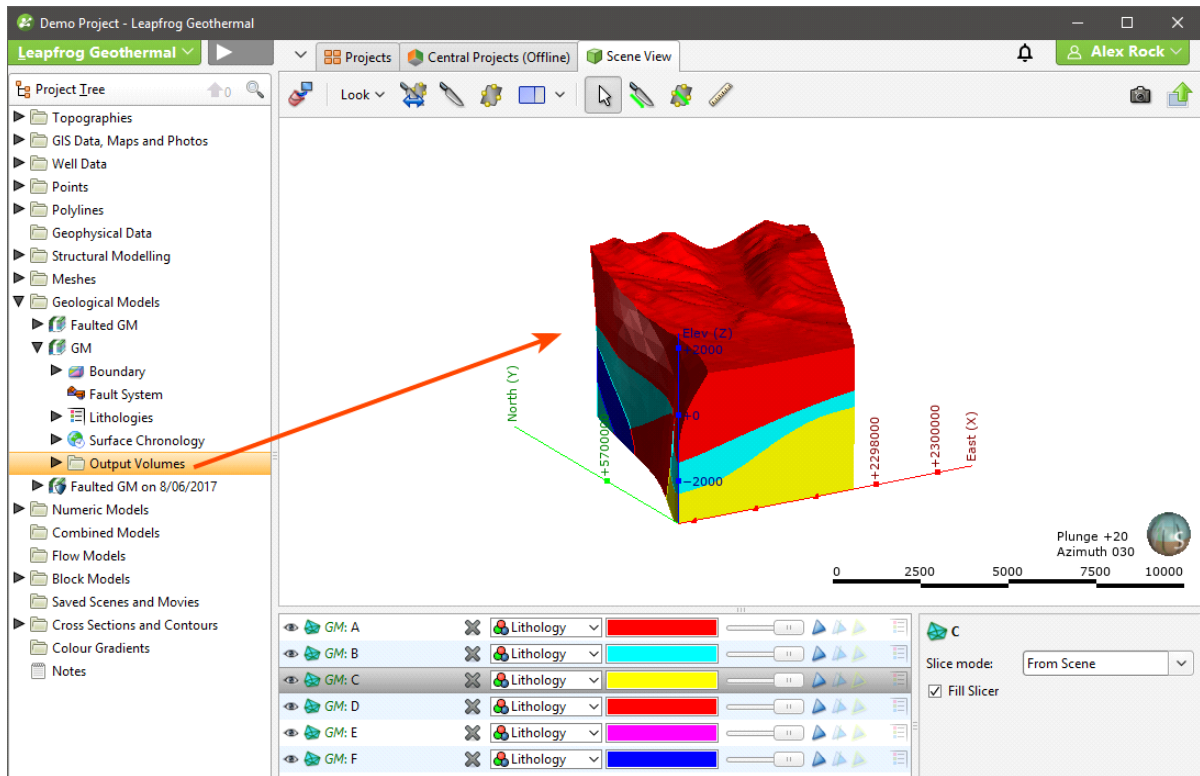

The five objects underneath the geological model “GM” represent the five basic parts of a geological model:

- The **Boundary** object defines the outer limits of the geological model.
- The **Fault System** object defines faults and their interactions in the geological model.
- The **Lithologies** object defines the lithologies in the model.
- The **Surface Chronology** object defines the structure of the model’s contact surfaces.
- The **Output Volumes** folder contains the generated units (outputs) that make up the geological model.

Here, boundary objects for a geological model have been expanded to show how they were created:

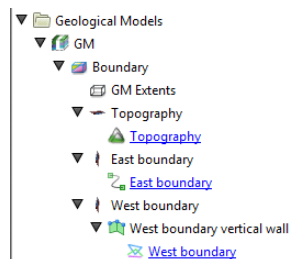

The **Topography** object is included as the model’s upper boundary. The “East boundary” object was created using a polyline from the **Polylines** folder and the “West boundary” object was created using a GIS data object in the **GIS Data, Maps and Photos** folder. Clicking on the hyperlinks will locate the object from which the extent was created.

Organising Objects in the Project Tree

Leapfrog Geothermal has a number of tools to help you organise the large numbers of objects in a project. One of these tools is the use of display lines in the project tree to better show relationships:

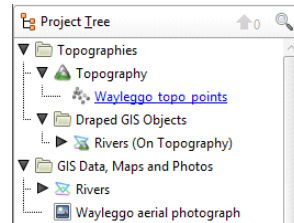

If you wish to display line in the project tree, open the **Settings** window from the **Leapfrog Geothermal** menu. Click on **User Interface** and enable **Show Tree Lines**.

When you have a large number of folders open in the project tree, you can close all folders by right-clicking on the top of the project tree and selecting **Collapse All**:

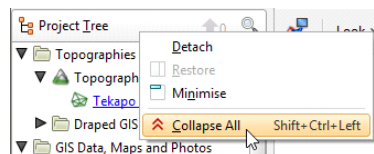

Hotkeys for opening and closing folders include:

- Ctrl + shift + left arrow collapses all folders.
- Right arrow expands a collapsed folder or object but keeps child objects collapsed.
- Shift + right arrow expands a collapsed folder or object and child objects.
- Left arrow collapses an expanded folder or object but keeps child objects expanded.
- Shift + left arrow collapses an expanded folder or object and child objects.

Hotkeys work with more than one object selected.

Subfolders

In many project tree folders, you can create subfolders that help in organising large numbers of data objects. For example, here colour gradients have been organised into subfolders:

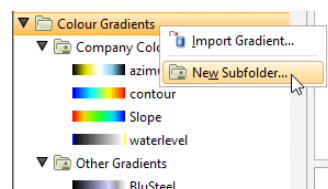

To add a subfolder, right-click on a folder in the project tree and select **New Subfolder**. Add objects to subfolders by dragging and dropping them. You can also use **Cut** (Ctrl-X) and **Paste** (Ctrl-V) shortcuts to move objects and subfolders.

Subfolders can be renamed, moved and deleted, but cannot be moved to other top-level folders.

Subfolders have the same right-click commands as their parent folder, which means you can import or create new data objects inside the subfolder rather than in the parent folder. You can also add comments to folders to aid in keeping data organised:

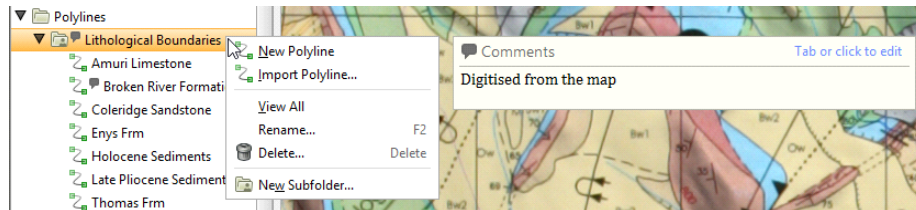

You can view all objects in the subfolder by dragging the folder into the scene or by right-clicking on the subfolder and selecting **View All**.

When lists of objects are displayed, the subfolder organisation will be reflected in the list. For example, when creating an interpolant, the list of data objects that can be interpolated is displayed organised by subfolder:

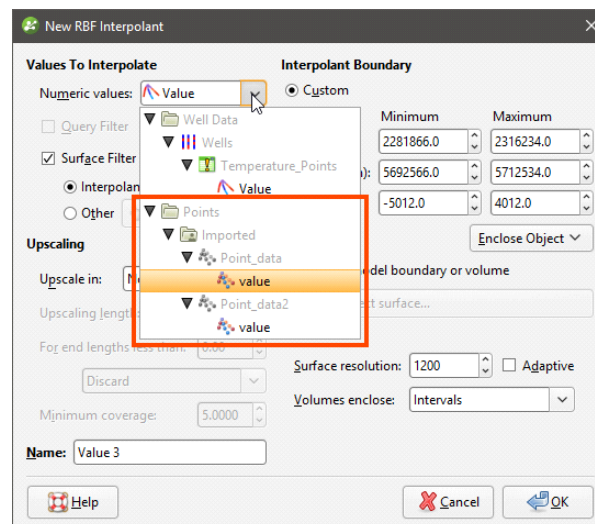

Subfolders cannot be created in the **Well Data** folder, although they can be created in the **Composites** and **Planned Wells** folders.

Copying Objects

Many objects in the project tree can be copied. Right-click on an object and select **Copy**. You will be prompted to enter a name for the object's copy.

The copied object is not linked to the original object. However, if the original object is linked to other objects in the project, the copy will also be linked to those objects.

Renaming Objects

When an object is created in Leapfrog Geothermal, it is given a default name. It is a good idea to give objects in Leapfrog Geothermal names that will help you distinguish them from other objects, as large projects with complicated models will contain many objects.

To rename an object in the project tree, right-click on the object and select **Rename**. The **Rename Object** window will be displayed:

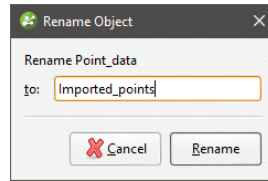

Enter a new name for the object. Click **Rename** to change the object's name.

Finding Objects

To find objects in the project tree, click the search button at the top of the project tree:

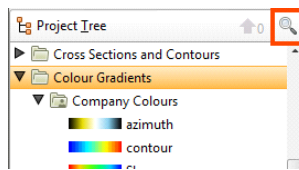

You can also click anywhere in the project tree and type "Ctrl-F".

The **Find** window will be displayed:

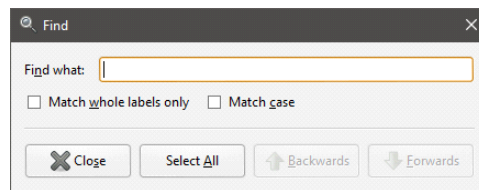

Enter the information you are searching for, then click **Backwards** or **Forwards** to locate the object in the project tree.

Deleting Objects

When you delete an object from the project tree, a window will be displayed listing all other objects in the project that will also be deleted and those that will be reprocessed. Some objects will be put into an error state; you will need to correct those errors before the affected object can be used elsewhere in the project.

Consider carefully the effects on other objects in the project, as once an object is deleted, it cannot be recovered.

Deleting data from the project may cause other objects to be reprocessed, which can take some time.

To delete more than one object from the tree, hold down the Shift key or the Ctrl key while selecting objects.

Sharing Objects

Some objects are created as part of working with other objects and are not available elsewhere in the project. An example of this is a polyline drawn as part of creating a model boundary. To share such objects within the project, right-click on the object in the project tree and click **Share**. The shared object will be copied to the relevant location in the project tree and a hyperlink added to the object it was shared from.

For example, here a polyline created as part of a lateral extent is shared:

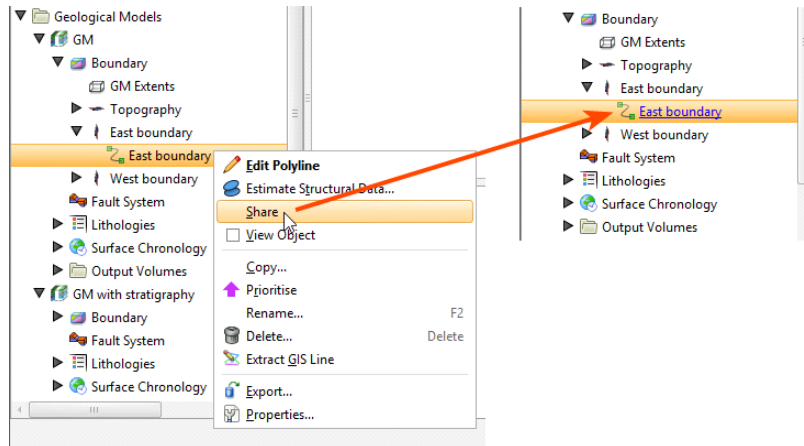

The polyline is saved to the **Polylines** folder and a hyperlink to it appears as part of the model's boundary. Whenever the polyline is updated, changes will be made wherever it is shared in the project.

Polylines that have been shared can be unshared. See [Sharing and Unsharing Polylines](#) for more information.

Object Properties

You can view the properties of most objects imported into or created in Leapfrog Geothermal. To do this, right-click on the object in the project tree and select **Properties**.

The information available in the **Properties** window depends on the type of object. Tabs may include:

- A **Processing** tab that shows the current status of the processing (queued to process, processing, finished).
- An **Errors** tab that displays errors that have occurred while processing the object. See [Processing Tasks](#).
- A **General** tab that summarises information about the object. The amount of information in the **General** tab will vary according to the type of object. For example, for table objects, the **General** tab shows the table's data structure.

- A **Statistics** tab that shows statistics for some types of interpolants.
 - For RBF interpolants, see [RBF Interpolant Statistics](#).
 - For multi-domained RBF interpolants, see [Sub-Interpolant Statistics](#).
 - For indicator RBF interpolants, see [Indicator RBF Interpolant Statistics](#).

Comments

Another aid to documenting work in a project is comments.

You can record comments on many objects in the project tree, including subfolders. This can be helpful when the project contains many objects and when several different people are working on a model. Objects that have comments are indicated in the project tree by a comment balloon (💬). The comment will be displayed when you right-click on the object:

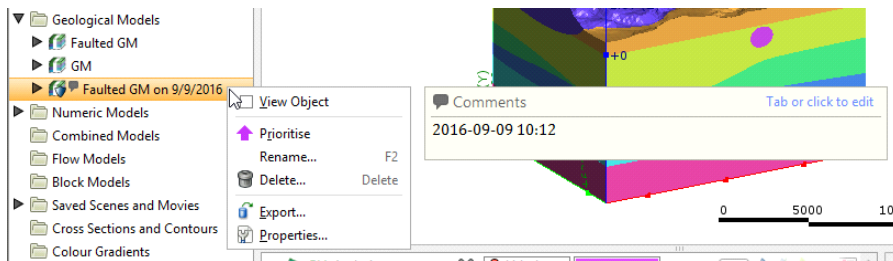

Tab or click to add a new comment or edit an existing one. You can also add standard information to a comment, such as date and time. If you add a URL to a comment, it will be converted to a clickable link.

You can add information about the project as a whole using the **Notes** object (📝), which is the last object in the project tree. Double-click on the **Notes** object to open it and add information. When viewing projects in the **Projects** tab, information in a project's **Notes** will be displayed when you hold the mouse cursor over the project's thumbnail:

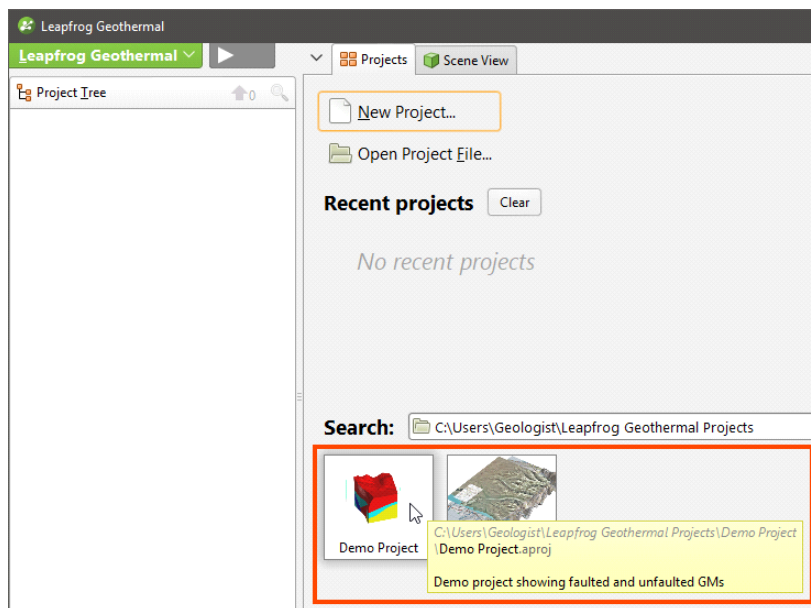

Processing Tasks

The processing queue button shows how many tasks are currently being processed:

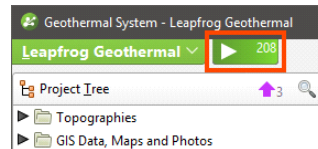

Objects will be added to the processing queue when you make changes to them via the project tree.

- To view the queue and progress on processing, click the queue button or press Alt + P.
- To pause processing, press Ctrl + P. To resume processing, press Ctrl + P again.

The button will turn grey when all processing is complete.

You can close a project while it is still running tasks. When you next open the project, the remainder of the tasks in the processing queue will be processed.

Prioritising Tasks

Tasks can be prioritised and their inputs processed before other objects. To prioritise a task, right-click on an object in the project tree and select **Prioritise**. Prioritised tasks are marked in the project tree with an arrow:

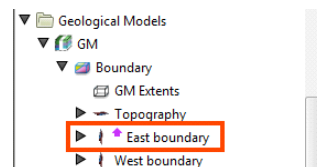

Prioritising an object is useful when you are editing it and wish to view the effect of changes without reprocessing all objects in the project. For example, you may be modifying a surface that is used for a model boundary. You can prioritise the surface, then run it each time you make changes.

To run only prioritised tasks, click the processing queue button, then click **Priority Only**:

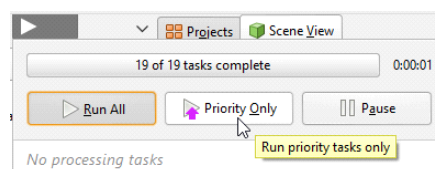

The processing queue button will change to show that only priority tasks will be run:

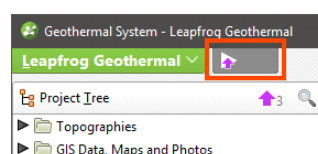

The number of objects that have been prioritised is indicated by the button at the top of the project tree (📌 3). To view prioritised tasks, click the button. All prioritised objects will be selected and displayed in the project tree.

To reset a priority object, right-click on it and select **Clear Priority**.

Click the processing queue button, then click **Run All** to resume normal processing.

Correcting Errors

If processing of an object fails, all other objects dependent on that object will also fail. Click the processing queue button to view the errors. To inspect the source of error, right-click on the object in the task queue and select **Go to Project Tree > Show Error**:

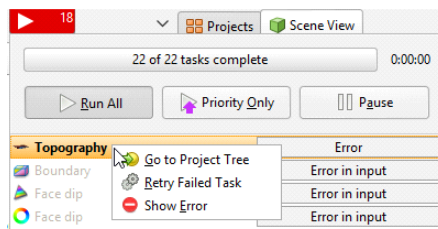

The object's **Properties** window will be opened with the **Errors** tab displayed. The information in this tab may be helpful in fixing the error.

Project Tree Keyboard Shortcuts

Keyboard shortcuts for navigating in the project tree are as follows:

Key(s)	Action
Up and down arrows	Navigate up and down the tree
Right arrow	Expand folder/object or go down one level
Left arrow	Close folder/object or go up one level
Ctrl+shift+left arrow	Close all folders/objects
Shift+right arrow	Expand the selected folder/object and any objects in it
Shift+left arrow	Close the selected folder/object and any objects in it
Ctrl+A and Ctrl+/ Ctrl+F	Selects all folders and objects
Ctrl+F	Search for objects
Enter	The equivalent of double-clicking on an object
Ctrl-X	Cut an object or subfolder. Use with Ctrl-V to move objects and subfolders.
Ctrl-V	Paste an object or subfolder

Some actions are not available until data has been imported into the project.

The 3D Scene

This topic describes how to interact with the 3D scene. It is divided into:

- [Locating an Object from the Scene](#)
- [Slicing Through the Data](#)
- [Measuring in the Scene](#)
- [Working With Split Views](#)

How to change the way objects are displayed in the scene is described in a separate topic, [Visualising Data](#).

The best way to navigate the 3D scene in Leapfrog Geothermal is using the mouse. If you are running Leapfrog Geothermal on a laptop, it is recommended that you plug in a mouse rather than using the laptop's touchpad for navigation. However, you can also navigate in the scene using the keyboard.

Action	Mouse	Keyboard
Changing the viewing angle	Click and drag to rotate the scene	Press the arrow keys to rotate the scene For smaller steps, hold down the Shift key while pressing the arrow keys
Zooming in and out of the scene	Use the scroll wheel Hold the right mouse button while moving the mouse	Press the Page Up or Page Down keys For smaller steps, hold down the Shift key while pressing the Page Up or Page Down keys
Panning the scene	Click and hold both mouse buttons, then drag Hold the scroll wheel and drag	Hold down the Alt key while pressing the arrow keys
Centre an object in the scene	Click the scroll wheel Click both mouse buttons together	

Use the **Look** menu above the scene window to switch to different viewing angles:

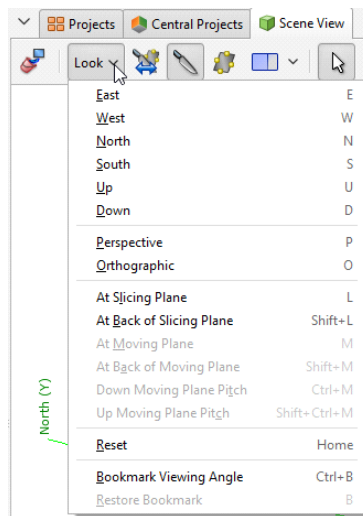

If you prefer to navigate using the keyboard, use the following keyboard shortcuts:

Key(s)	Action
Arrow keys	Rotate the scene in 10 degree steps
Shift+Arrow keys	Rotate the scene in 2 degree steps
Home	Reset the view, showing all visible objects in scene
U, D, E, W, N, S	Look Up, Down, East, West, North and South
L	Look at the slicing plane
Shift+L	Look at the back of the slicing plane
M	Look at the moving plane
Shift+M	Look at the back of the moving plane
Ctrl+M	Look down the moving plane pitch
Shift+Ctrl+M	Look up the moving plane pitch
P	Select Perspective view
O	Select Orthographic view
Ctrl+Delete	Clear the scene
Ctrl+B	Bookmark the viewing angle and zoom
B	Display the bookmarked viewing angle and zoom
Ctrl+'	Save the scene
Ctrl+C	Copies the scene to the clipboard. The image can then be pasted into another application, such as an image editor.
Ctrl+/'	Add the slicer to the scene. Press Ctrl+/' to remove the slicer from the scene.
Ctrl+;	Add the moving plane to the scene. Press Ctrl+; to remove the moving plane from the scene.

The current viewing angle and scale are displayed in the lower right-hand corner of the scene window:

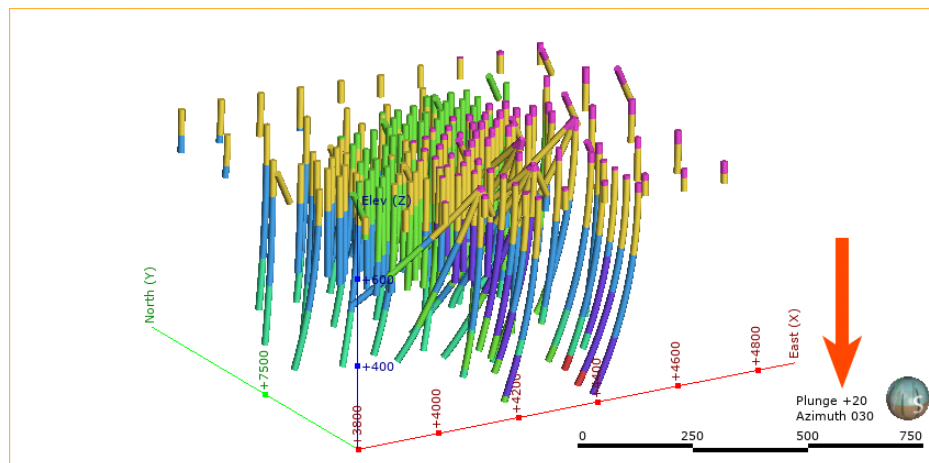

You can change how the viewing angle and scale are displayed in the **Overlays** tab of the **Settings** window.

You can save the current viewing angle as a bookmark by selecting **Bookmark Viewing Angle** from the **Look** menu or by pressing Ctrl+B. Restore the bookmark by selecting **Look > Restore Bookmark** or by pressing B.

Only one viewing angle bookmark can be saved. The bookmark is not saved when Leapfrog Geothermal is shut down.

The scene window displays a 3D representation of selected data from the project tree. You can add objects from the project tree to the scene in two ways:

- Click on the object and drag it into the scene. Hold down the Shift key or the Ctrl key while clicking to select multiple items, then add them to the scene.
- Right-click on the object and tick the **View Object** box.

Dragging objects into the scene window may be blocked by other applications on your computer. For example, if you are sharing a screen using Skype, you will not be able to drag objects into the scene.

Once you have added objects to the scene window, you can change the appearance of those objects using the controls in the shape list and the shape properties panel.

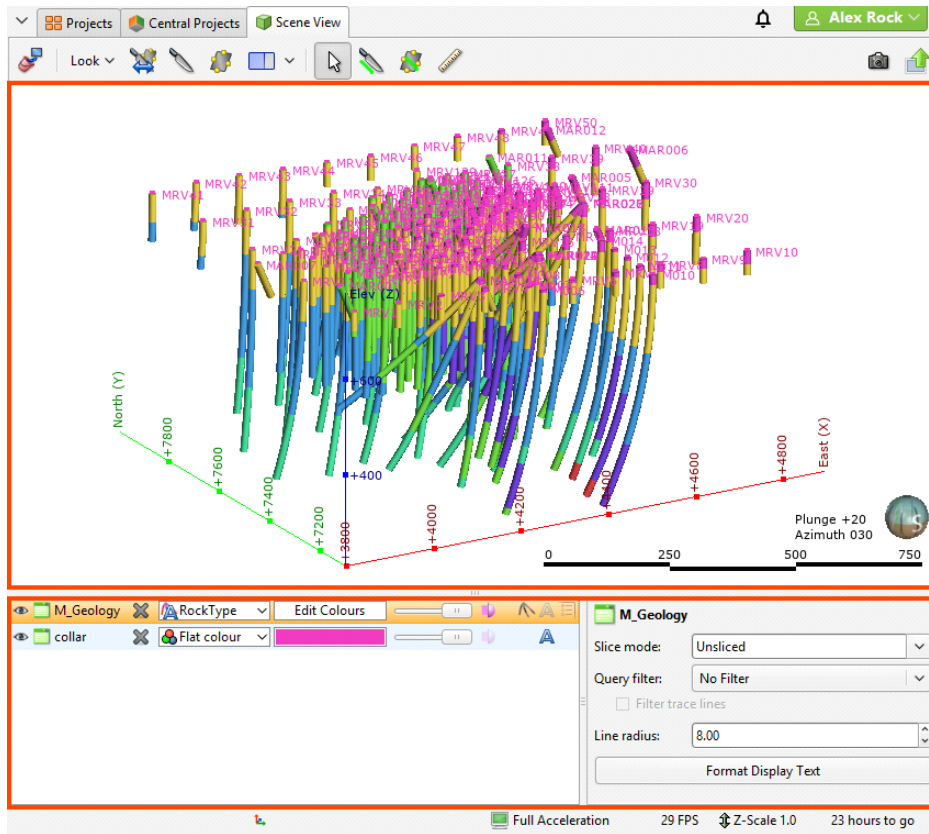

This is described further in [Visualising Data](#).

Changing how you view objects in the scene window does not change those objects in the project tree.

All objects in the shape list have a button (✕) that will remove the object from the scene. Most objects also have a visibility button (👁) that can temporarily hide that object in the scene. It is often easier to make an object temporarily invisible than to remove it from the list. Some objects have an edit button (✎) that you can click to begin editing the object.

Locating an Object from the Scene

When you have a number of objects displayed in the scene, it may not be readily apparent where you can find more information about those objects. Leapfrog Geothermal helps you find the object in the project tree and the shape list in two ways, by [Clicking in the Scene](#) and by [Clicking in the Shape List](#).

Clicking in the Scene

Clicking on an object in the scene displays a window that contains a summary of the data and, for many objects, a link to the corresponding data in the project tree. For example, here well data is displayed in the scene and clicking on a segment displays the corresponding data:

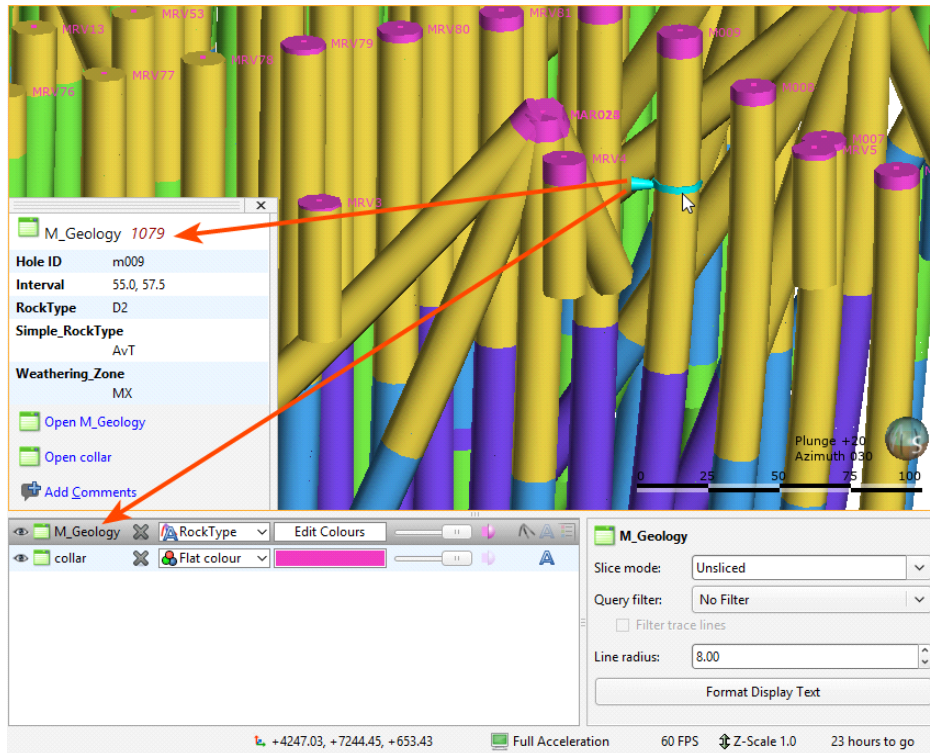

Note that clicking on an object in the scene also selects it in the shape list.

Clicking in the Shape List

When you have objects displayed in the shape list and want to locate them in the project tree, simply right-click on the object in the shape list and select **Go to Project Tree**:

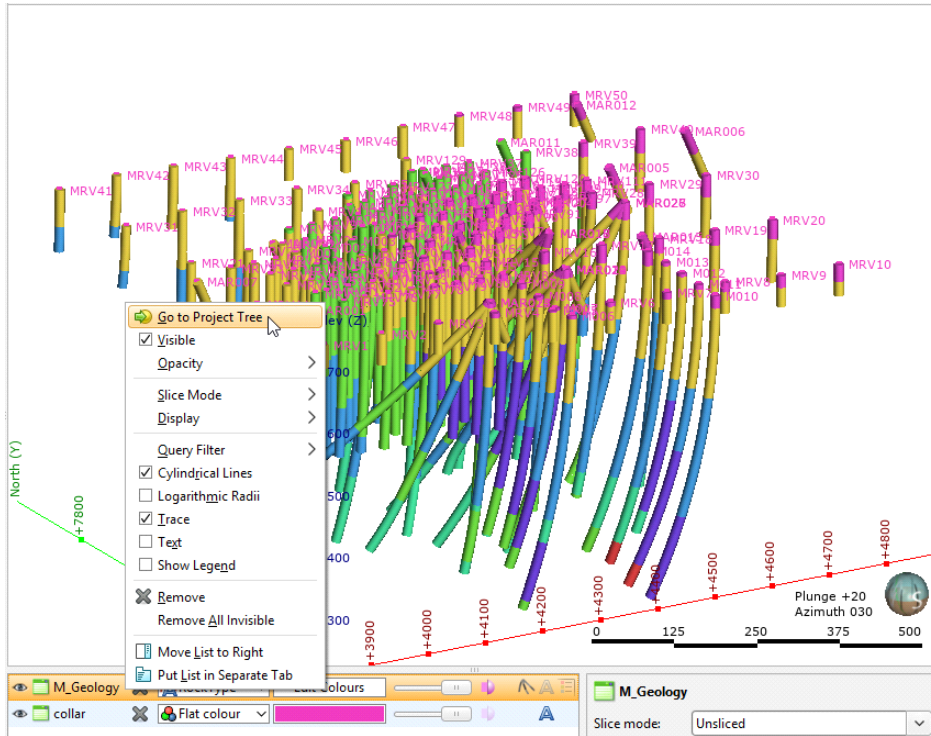

The object's location in the project tree will be expanded and the object will be selected.

Slicing Through the Data

The slicer is a powerful tool for revealing data that is concealed behind other objects and for emphasising data. Slicing can be considered a form of dynamic sectioning.

Two buttons in the toolbar can be used to add the slicer to the scene:

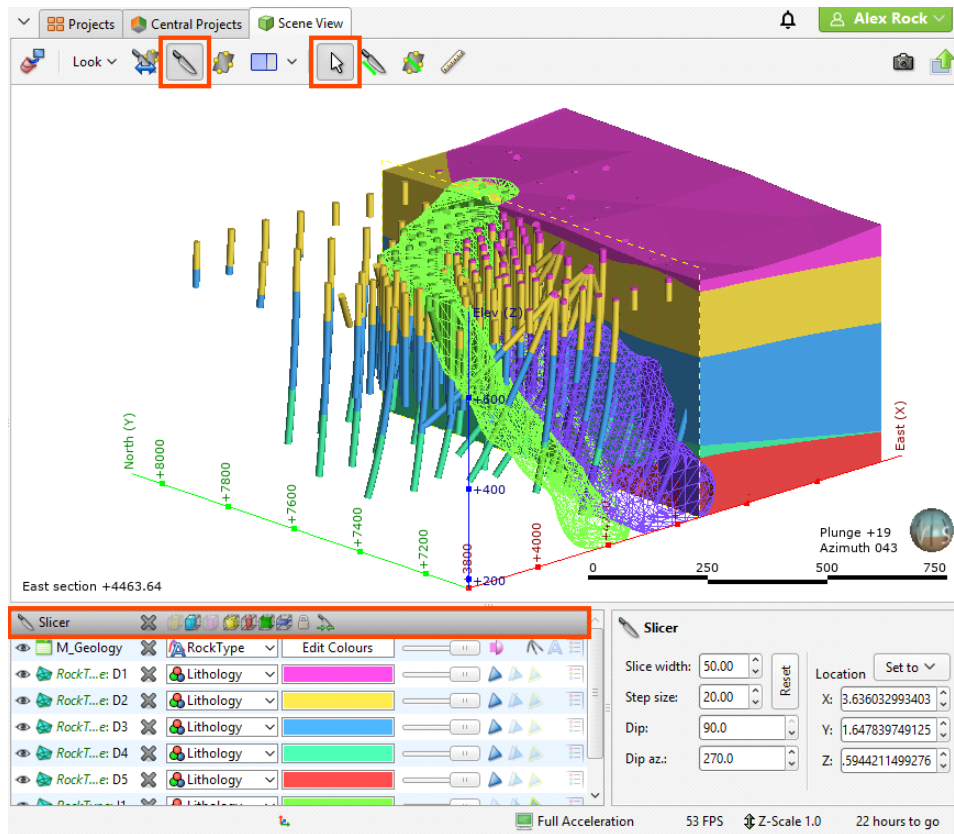

You can add the slicer to the scene by clicking the **Show slicer** button (🔪). The slicer will appear in the scene and you can adjust its position using the controls in the shape list:

You can also click the **Draw slicer line** button (🖋️), then click and drag in the scene to cut a slice through the scene.

The scene may appear empty because the slicer has removed all visible data. Reposition the slicer or turn it off.

Slicer Properties

You can change the way the slice appears in the scene using the controls in the shape list, and finer controls are available in the shape properties panel:

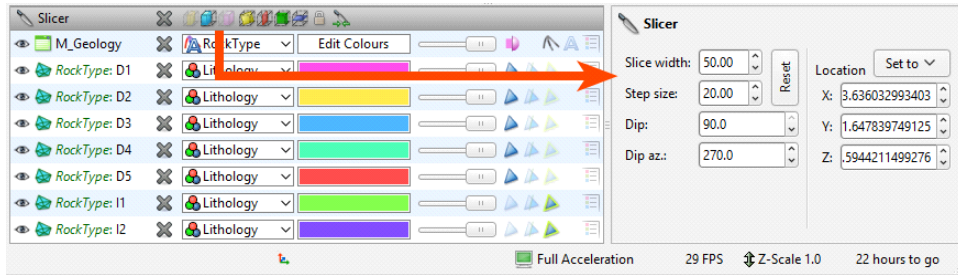

Right-click on the slicer in the shape list to view more information about each option:

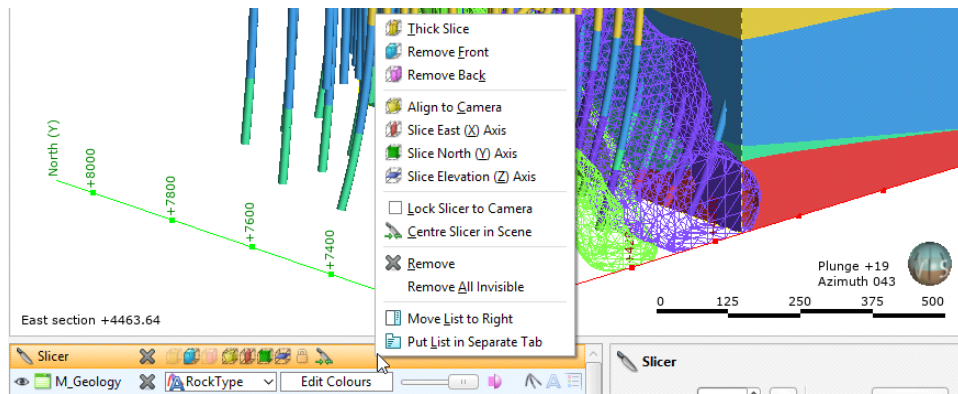

The **Lock to Camera** (🔒) option locks the slice to the current view so that moving the scene changes the direction of the slice.

These options can also be controlled from the **Look** menu:

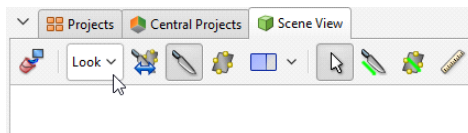

The **Set to** list in the shape properties panel contains standard views, together with any sections displayed in the scene:

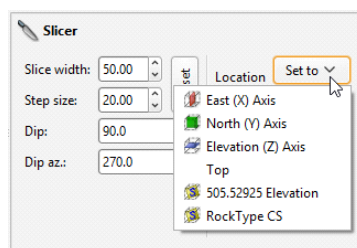

To move the slicing plane in a direction orthogonal to the slicing plane, hold down the Ctrl key and the right mouse button while dragging the mouse.

To change the thickness of a thick slice, hold down the Ctrl key and the middle mouse button while dragging the mouse. If you have a two-button mouse, hold both buttons.

Object Slice Mode

When you draw a slice in the scene, how objects in the scene are displayed in relation to the slicer is controlled in the properties panel for that object. For example, here the M_Geology table is selected in order to change how the wells are displayed in relation to the slicer:

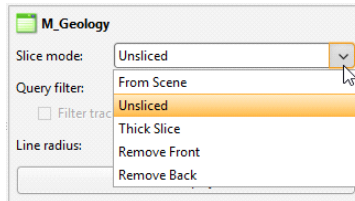

The **From Scene** setting is the default; the object is sliced according to the properties set for the slicer.



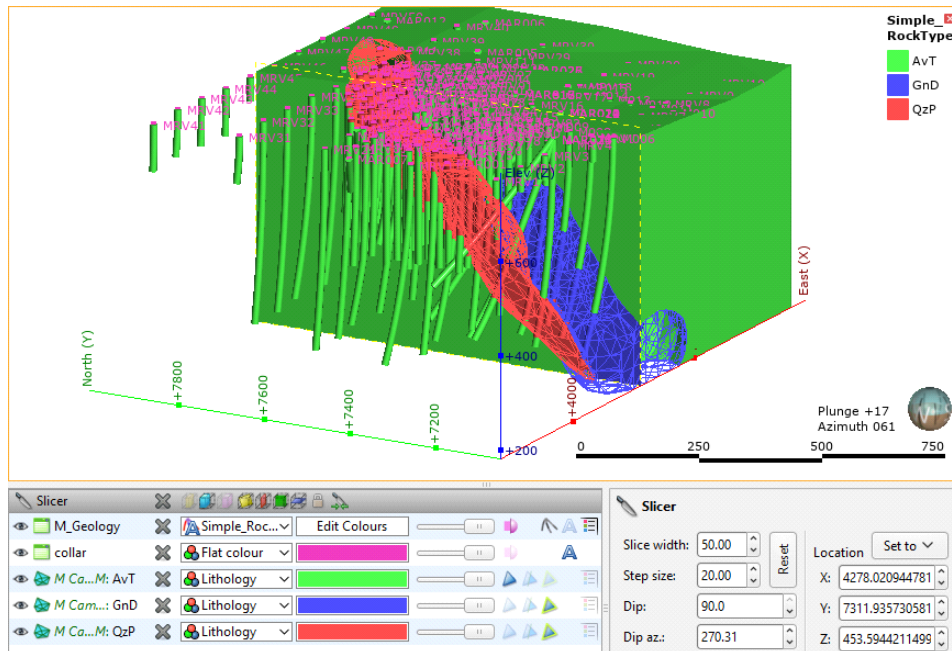



By changing the **Slice mode** for objects in the scene, you can illustrate how a model has been constructed:



Slicer Shortcuts

Use the following keyboard shortcuts to control the slicer:

Key(s)	Action
Ctrl+/ L	Add the slicer to the scene. Press Ctrl+/ to remove the slicer from the scene.
L	Look at the slicing plane
Shift+L	Look at the back of the slicing plane
T	Thick slice (🔧)

Key(s)	Action
F	Remove front 
K	Remove back 
Ctrl+V	Orient the slicer to the current view
Ctrl+E	Slice the east (X) axis 
Ctrl+N	Slice the north (Y) axis 
Ctrl+D	Slice the elevation (Z) axis 
Ctrl+L	Lock the slicer to the camera 
C	Centre the slicer in the scene
Ctrl+right mouse button	Move the slicer forward and backward in the scene
Ctrl+middle (or left+right) mouse button	Change the slice width
, (comma)	Step the slicer forward
. (full stop)	Step the slicer backward

Measuring in the Scene

Leapfrog Geothermal has a number of tools for making quantitative measurements in the scene. These include:

- Clicking on an object in the scene. This will open a window containing more information about the object.
- Viewing an object's properties to determine its size. Right-click on the object in the project tree and select **Properties**. Information on the size of the object will be displayed in the **General** tab.
- Using the cursor to determine an approximate location in the scene. See [Determining a Location](#).
- Using the moving plane to measure trends. See [The Moving Plane](#).
- Using the ruler to measure in the scene. See [The Ruler](#).

Determining a Location

The simplest way of measuring an approximate location in the scene is to first display an object in the scene window, then position the cursor over the location. The position of the cursor is displayed at the bottom of the Leapfrog Geothermal window:

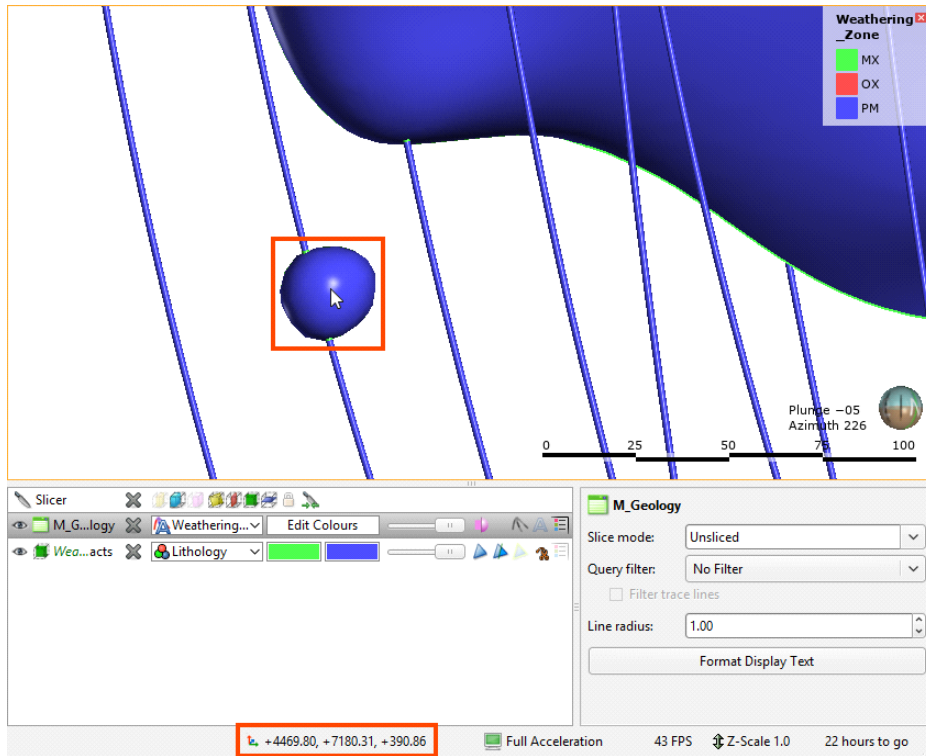

The position of the cursor in the scene is calculated using the depth buffer on the graphics card and so is not an exact method of measuring in the scene.

If you require an exact position, click on the object. Leapfrog Geothermal will compute the exact position of the point highlighted in the scene and display it in a pop-up window:

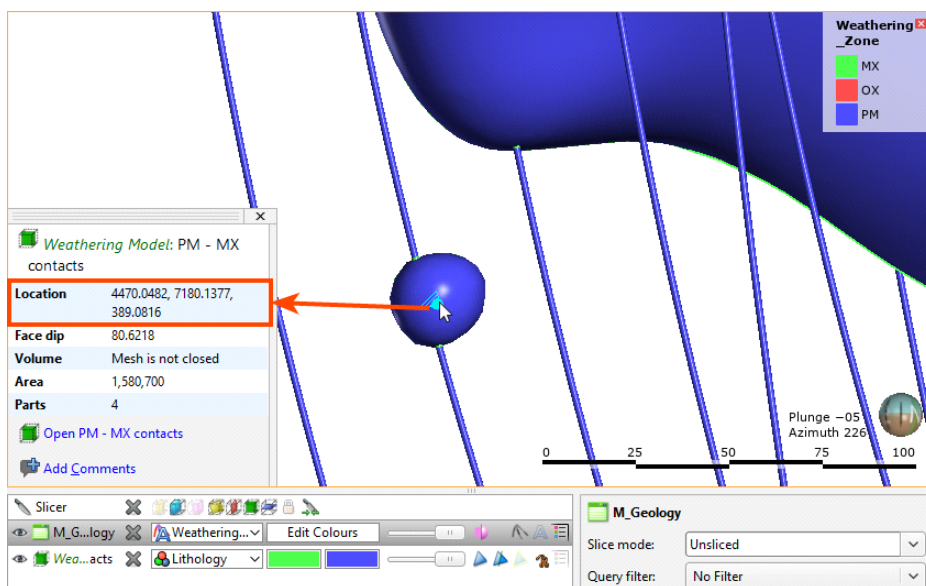

The Moving Plane

In Leapfrog Geothermal, the moving plane is used for measuring planar structures and defining coordinate system orientations. There are two tools in the toolbar that relate to the moving plane:

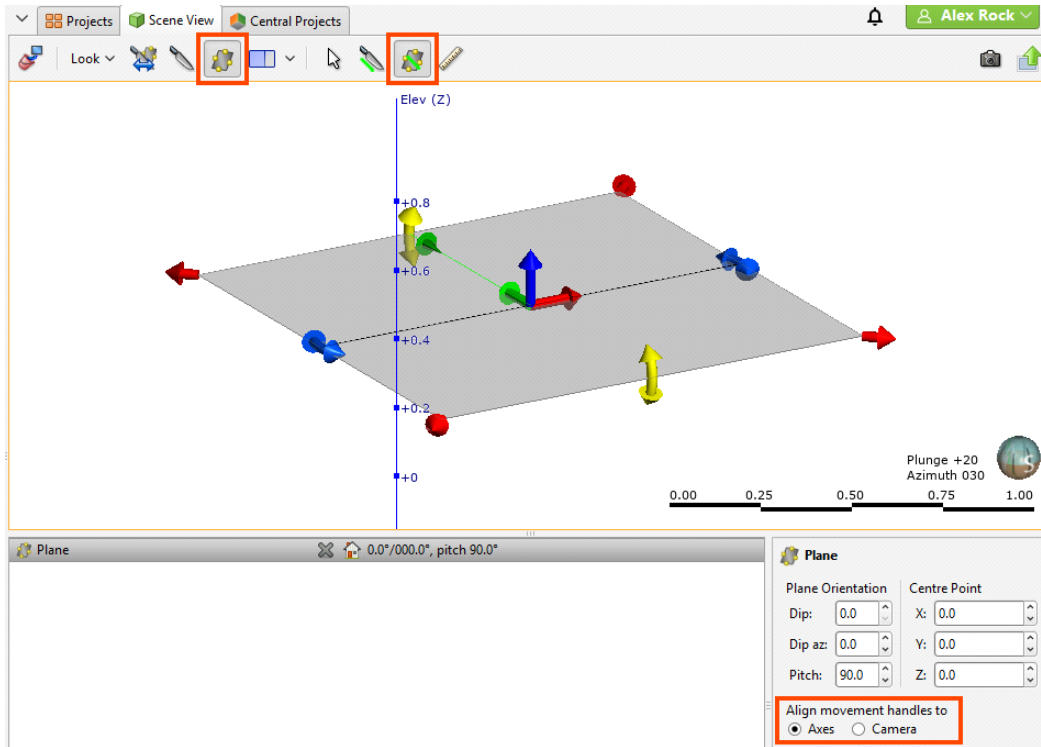

To use the moving plane, click the **Show plane** button (📐) and position the plane in the scene. The main axis of the moving plane is defined by the green line. The second axis is defined to be in the plane at right angles (orthogonal) to the main axis. Third axis is perpendicular to the plane.

There are three ways to position the plane. You can:

- Use the handles in the scene window to move the plane. If you cannot see the handles, click on the moving plane.
- Use the **Plane** controls in the shape properties panel to change the **Dip**, **Dip Azimuth**, **Pitch** and **Centre Point**.
- Orient the scene to look parallel to the required plane position, then click on the **Draw plane line** button (📐). Draw the required line in the scene.

Plane movement can be aligned to the **Axes** or to the **Camera**:

- With the **Axes** option, the handles move in cartesian coordinates. This is the only option available in older versions of Leapfrog Geothermal.
- With the **Camera** option, the handles move relative to the camera angle. This is the way the moving plane handles worked in Leapfrog Mining.

Drawing the plane line is usually the most convenient method of defining a planar structure.

To remove the moving plane from the scene:

- Click the **Show plane** button (🗑️).
- In the shape list, click the delete button (✖️) for the moving plane.

Use the following keyboard shortcuts to control the moving plane:

Key(s)	Action
Ctrl+;	Add the moving plane to the scene. Press Ctrl+; to remove the moving plane from the scene.
M	Look at the moving plane
Shift+M	Look at the back of the moving plane
Ctrl+M	Look down the moving plane pitch
Shift+Ctrl+M	Look up the moving plane pitch

The Ruler

You can use the ruler to measure distances in three dimensional space and between wells and planned wells.

The easiest way to use the ruler is to click on the **Ruler** button (📏) and click and drag between points in the scene to start making measurements. A ruler line will appear in the scene to indicate the measurement. Information about the distance measured will appear in the scene and in the shape properties panel:

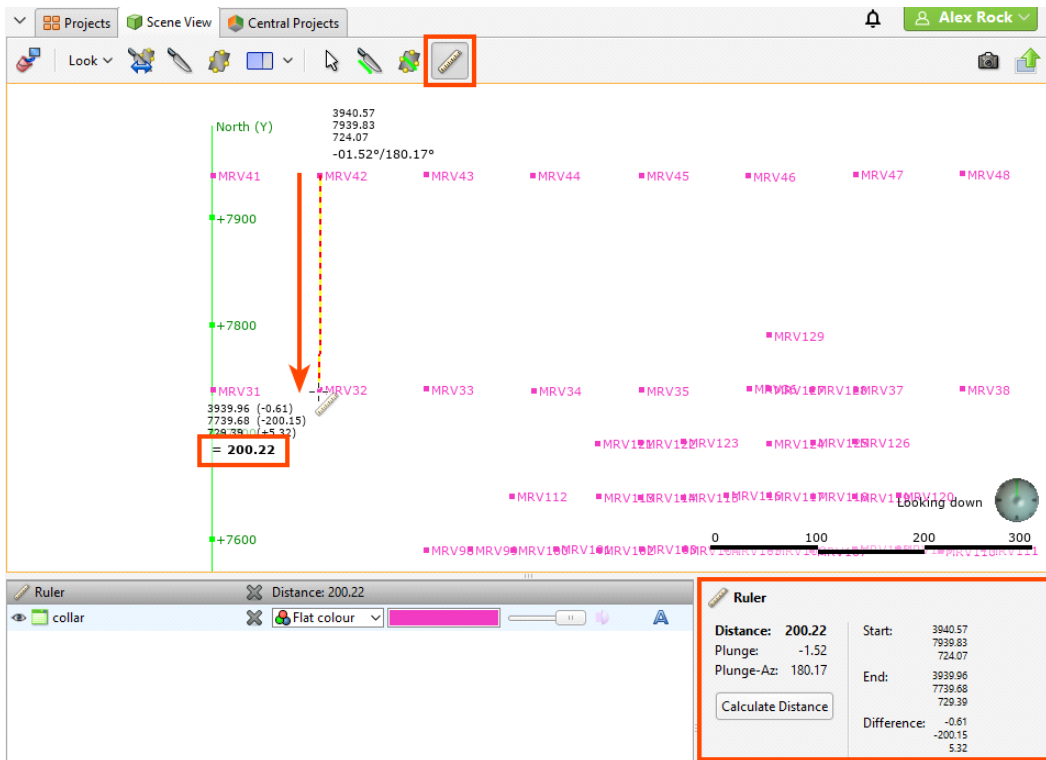

The ruler tool stays active in the scene so you can make as many measurements as required.

You can also measure the distance between wells or between wells and a point. To do this, click on the **Calculate Distance** button in the shape properties panel. The **Distance Calculator** window will appear:

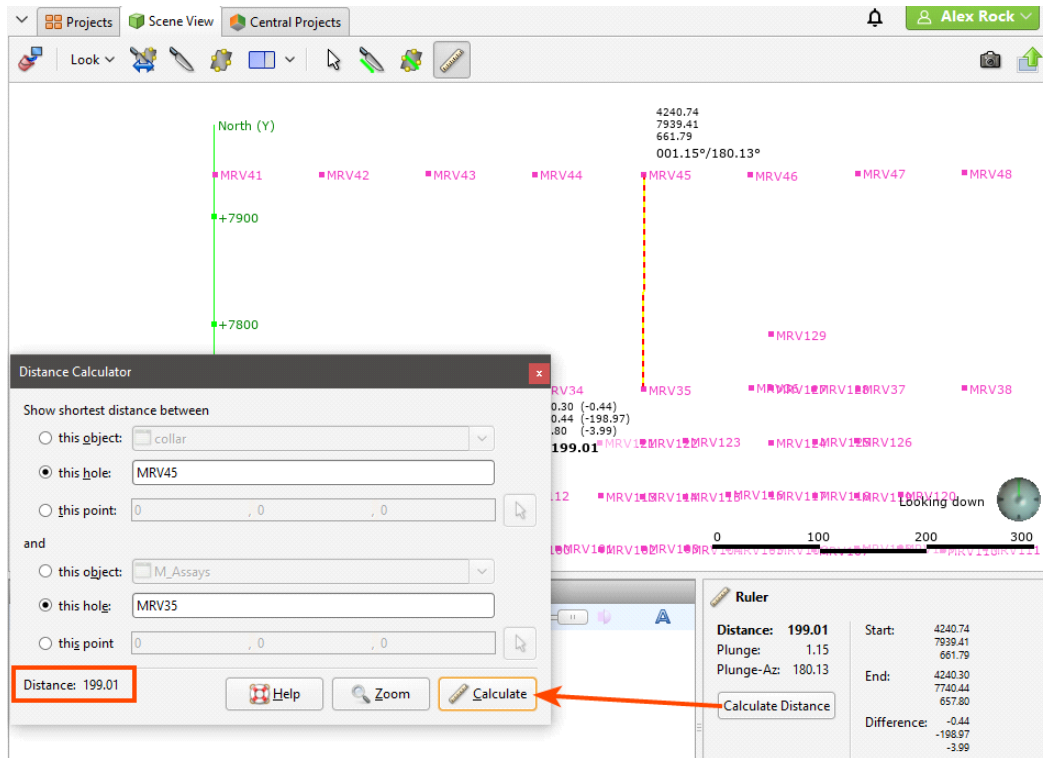

You can select both wells and planned wells. Click **Calculate** to calculate the distance and update the ruler in the scene. The distance value will appear in the **Distance Calculator** window.

You can also select a point in the scene by clicking the **Select** button (📍) in the **Distance Calculator** window, then clicking in the scene. The location of the point in the scene will appear in the **Distance Calculator** window.

After measuring a distance, it is a good idea to change the viewing angle to confirm that the measurement has been made between the correct points in three dimensions.

There are two ways to remove the ruler from the scene:

- Click the **Select** button (📍).
- Click the delete button (✖) for the ruler object in the shape list.

Working With Split Views

The **Split View** button (🗑️) in the toolbar allows you to view up to two alternative views of the objects displayed in the scene:

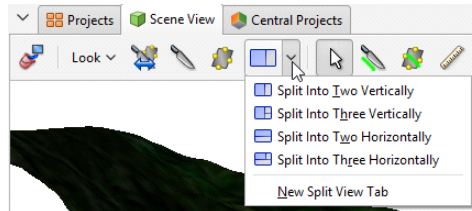

The alternative views available are a **Plan View** or a **Zoomed Out** view:

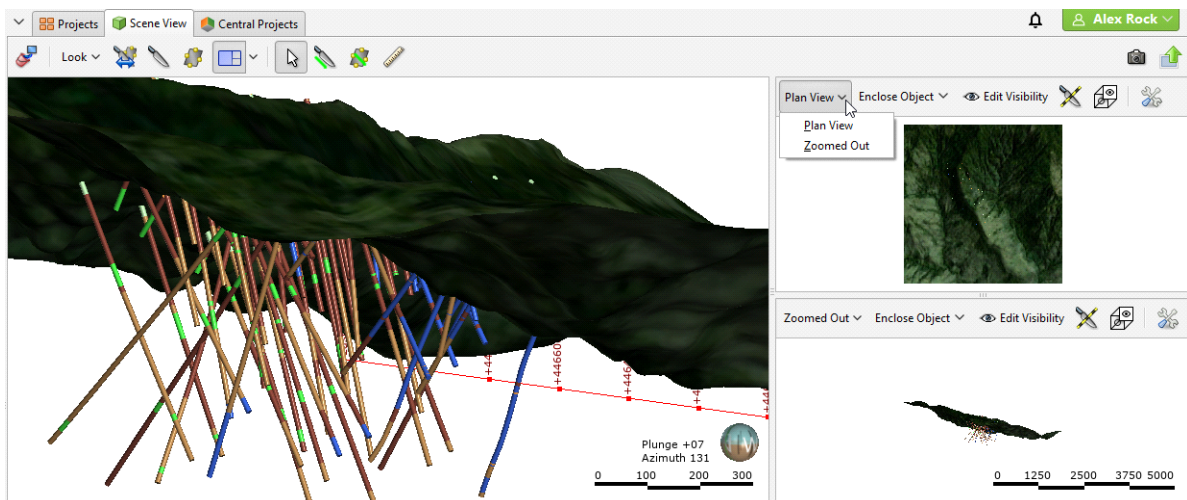

You can also open an alternative view in a new tab by choosing the **New Split View Tab** option:

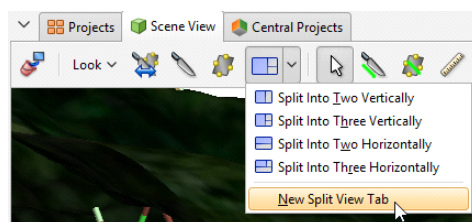

You can resize the scene and the alternative views and Leapfrog Geothermal will remember the position of each view when you switch to that split view again.

To return to displaying only the scene view, click the **Split View** button (🗑️).

Each alternative view has a toolbar that gives you different options for displaying the view. Use the **Enclose Object** list to zoom into or out of the alternative view:

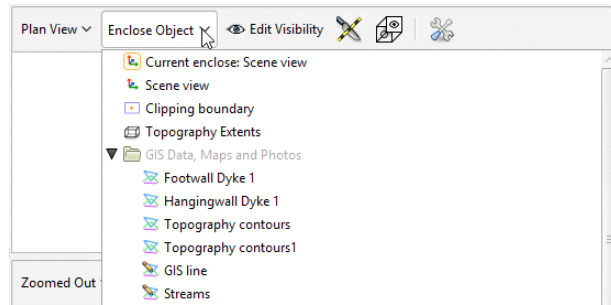

The list displayed includes all objects available in the project, plus the clipping boundary and the current scene view.

Click the **Edit Visibility** button (👁️) to change what objects from the scene view are visible in the alternative view:

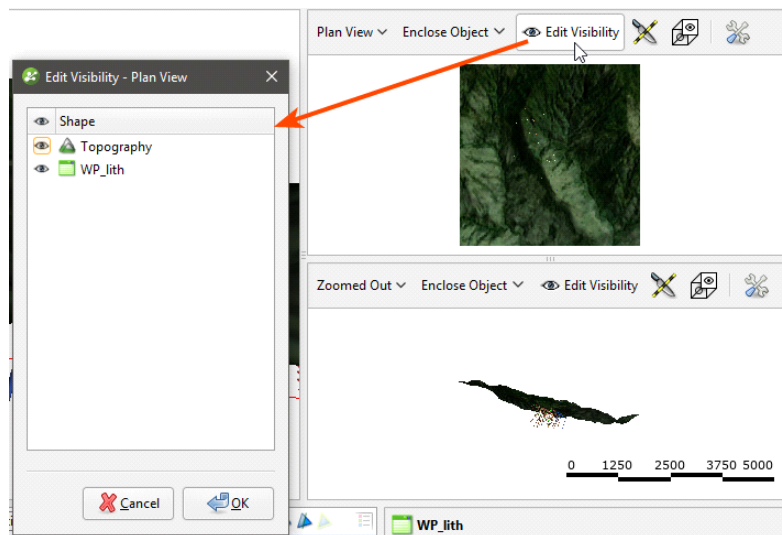

An object must be visible in the scene view's shape list for its visibility to be controllable from the alternative view's **Edit Visibility** list. What this means is that objects hidden in the scene view cannot be made visible in an alternative view.

When the slicer is in the main scene view, you can display the contents of the alternative view sliced or unsliced. Click the **View Unsliced** button (✕). The slicer, shown in blue in this image, remains displayed in the alternative views, but the view's contents are displayed unsliced:

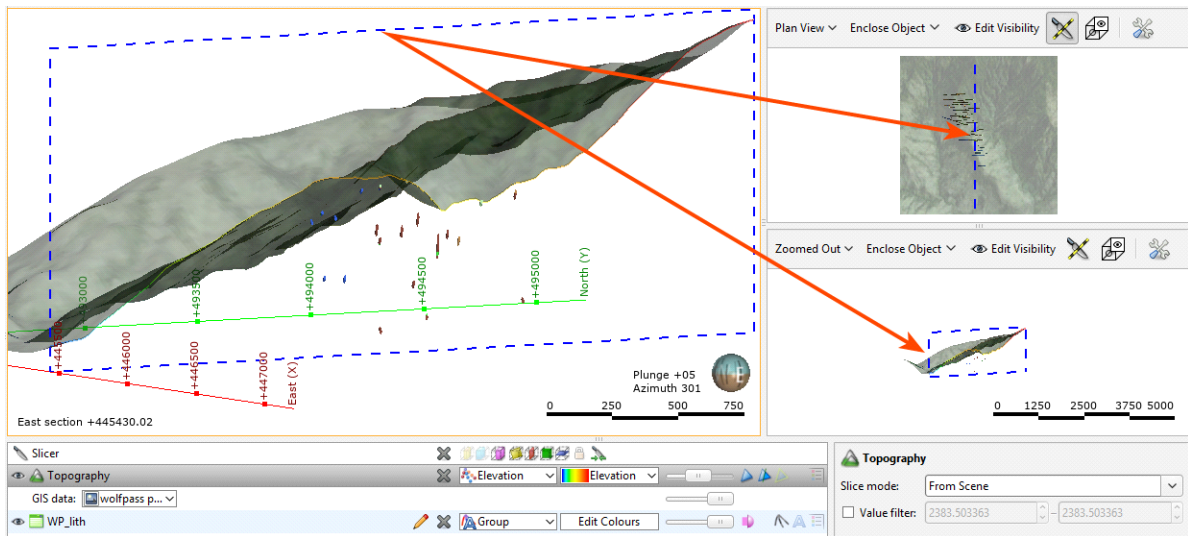

In alternative views, you can display a view window that shows what part of the alternative view is displayed in the scene view. Click the **Enable View Window** button (☞):



Each alternative view has a **Settings** button (⚙️) that lets you change what overlays are displayed for that view. The alternative view can use the scene view settings, or you can customise the display of the screen grid, axis lines and scale bar:

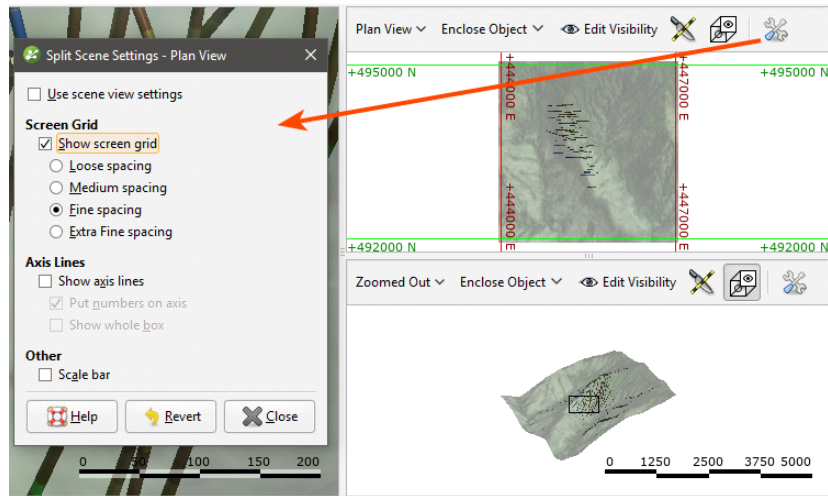

Visualising Data

Visualising data is an important part of interpreting and refining data and making modelling decisions. This topic describes the tools available for changing how data objects are displayed in the scene. It is divided into:

- [Colour Options](#)
- [Opacity](#)
- [Property Buttons](#)
- [Legends](#)
- [Slice Mode](#)
- [Filtering Data Using Queries](#)
- [Filtering Data Using Values and Categories](#)

Tools for visualising data are accessed via the shape list and the shape properties panel:

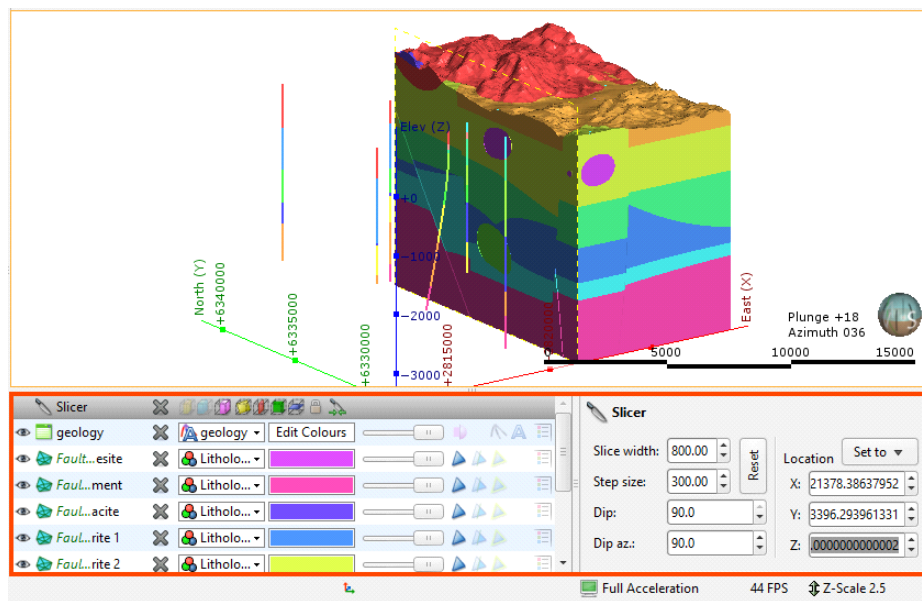

The tools available depend on the type of object being displayed.

Changing how you view objects in the scene does not change those objects in the project tree.

The view list is available for objects that can be displayed in different ways. For example, a lithology data table may contain several columns and the column displayed can be selected from the view list:

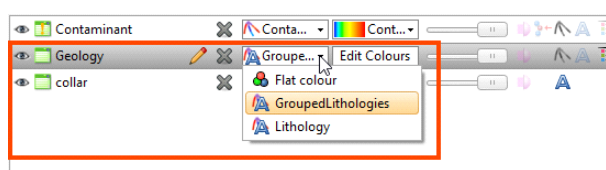

Geological and numeric model evaluations are also selected from the view list. See [Evaluations](#). The shape properties panel adjacent to the shape list provides more detailed control of the appearance of the selected object:

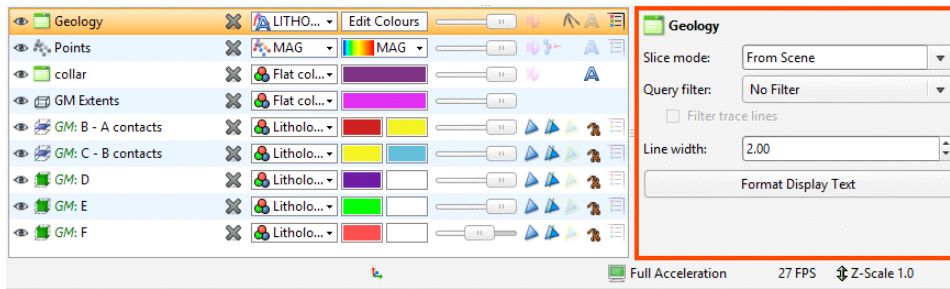

You can select multiple objects in the shape list and change their display properties using the shape properties panel. To do this, hold down the Shift or Ctrl key while clicking each object you wish to change:

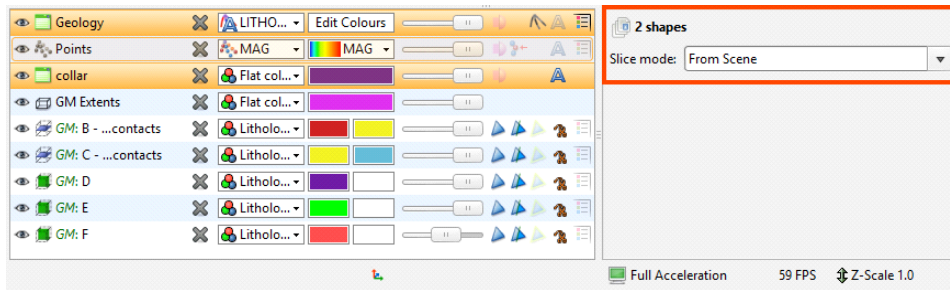

Only controls common to the selected objects are available.

Colour Options

The colour options for an object are changed in the shape list, and the options available depend on the type of object. Three different colour display options are shown below:

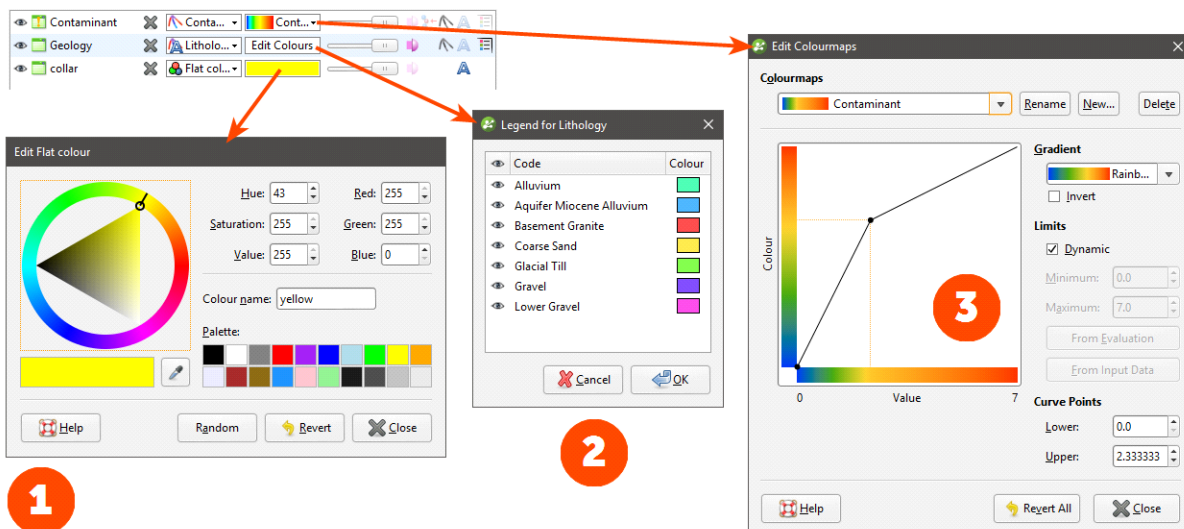

- The collar table is displayed using a single colour. Click the colour chip to change the colour. See [Single Colour Display](#).

- The Geology table is displayed according to a colourmap of the categories in the table. These colours can be changed by clicking on the **Edit Colours** button, then clicking on each colour chip in the **Legend** window.
- The Contaminant table uses a colourmap to display the numeric data. See [Colourmaps](#) for more information.

If your organisation uses standard colour coding for category and numeric data, you can import colourmaps for these data types. See [Colourmaps](#) below.

Single Colour Display

Many objects viewed in the scene are displayed using a single colour. To change the colour, add the object to the scene window, then click on the colour chip in the shape list. A window will appear in which you can change the colour:

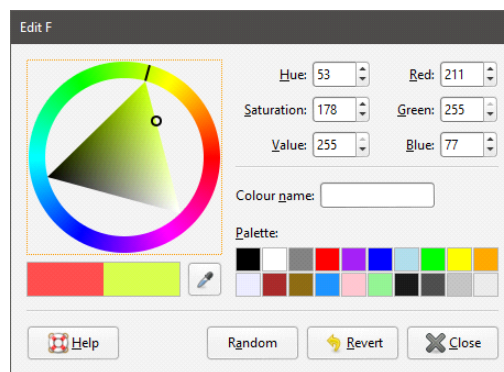

You can:

- Click and drag the ring to pick a colour, then select the darkness or lightness of the colour from the triangle.
- Click on the eyedropper tool (👁), then click on something elsewhere on the screen to select the colour of that part of the screen.
- Select a colour chip from the palette.
- Set a random colour.
- Enter specific values for the colour to use.

Changes made are automatically applied to the scene. The **Revert** button changes back to the colour assigned when the window was first opened.

Colourmaps

Numeric and category data are displayed using colourmaps that Leapfrog Geothermal automatically generates based on the data. Manually changing a colourmap often helps in understanding the data.

Colourmaps can easily be shared between projects on a column-by-column basis, which is useful if your organisation uses standard colourmaps. To import or export a colourmap, expand

the data object in the project tree and right-click on a column. The **Import** and **Export** options are available from the **Colours** menu:

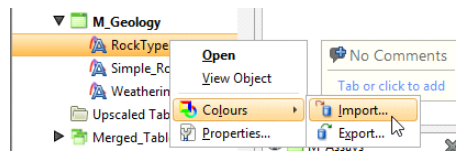

To export a colourmap, right-click on the data object and select **Colours > Export**. If more than one colourmap is associated with the selected object, you will be prompted to choose from those available. Click **Export**.

In the window that appears, navigate to the folder where you wish to save the colourmap. Enter a filename and click **Save**. The colourmap will be saved in *.lfc format.

When you import a colourmap:

- For category colourmaps, the existing colourmap will be overwritten.
- For numeric colourmaps, the imported colourmap will be added to those already defined.

To import a colourmap, right-click on the data object and select **Colours > Import**. Navigate to the folder containing the colourmap file and click **Open**.

If the object has more than one colourmap associated with it, you will be prompted to choose which one to overwrite.

If the column you expected is not listed, check to see if you have selected the correct file. The columns displayed are those that correspond to the type of data in the selected file (category or numeric).

Click **Import**.

Leapfrog Geothermal will map the information in the file to the information in the selected data column.

Category Colourmaps

Category data colourmaps can be edited by adding the data column to the scene, then clicking on the **Edit Colours** button in the shape list:

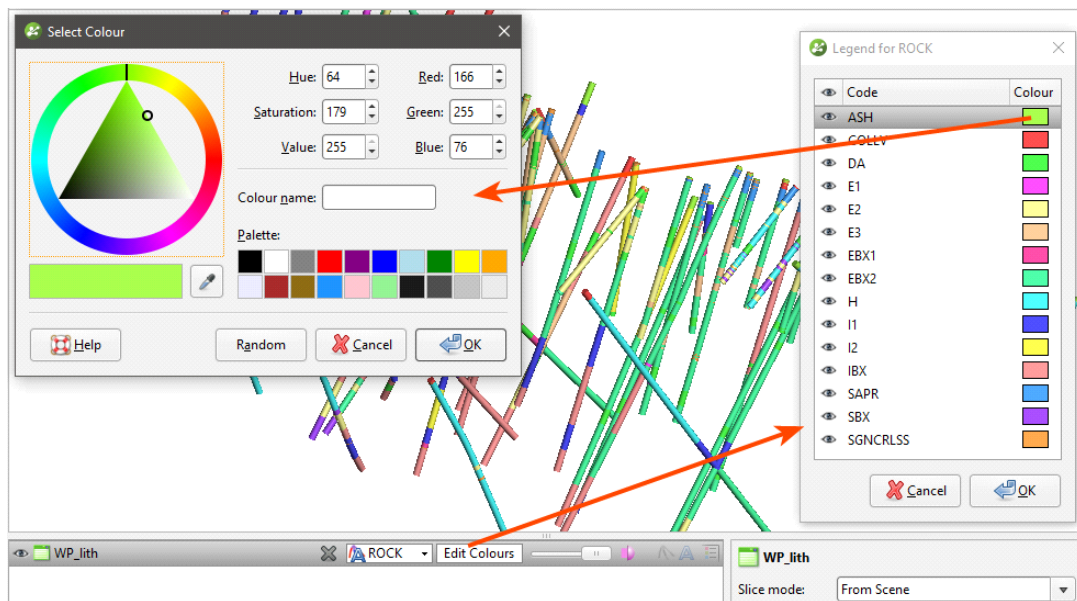

To change the colour used for a category, click on its colour chip in the **Legend** window. Category colourmaps can also be imported and exported, as described in [Colourmaps](#) above.

Numeric Data Colourmaps

There are two types of colourmap used for displaying numeric data:

- [Continuous Colourmaps](#)
- [Discrete Colourmaps](#)

Leapfrog Geothermal contains a number of preset colour gradients that are used in displaying both continuous and discrete numeric colourmaps. These are:

- **Rainbow (bgyr)**. This is a perceptually uniform rainbow.
- **Rainbow (bgyrm)**. This is similar to Rainbow (bgyr), but follows red with magenta, which is common in geophysics software and RQD (geotech).
- **Viridis**. This is a good linear gradient.
- **Plasma**. This is the default colourmap for face dip.
- **Linear (gow)**. This gradient is useful for elevation data.
- **Diverging (bwr)**. This colourmap can be used when you are interested in data at either end of the spectrum.
- **Spectral**. With this colourmap, the middle is not white, and white is reserved for bins that have no data.
- **Cyclic (mygbm)**. This is a good colourmap for azimuth data. Northern directions are displayed in blue and southern in yellow.

- **Grey (10-95)**. This grey colourmap works well on white and black backgrounds as it doesn't start or end in white or black.

Additional colour gradients can be imported into a project in the following formats:

- Geosoft Colour Files (*.tbl)
- ERMapper Lookup Tables (*.lut)
- MapInfo Colour Files (*.clr)
- Leapfrog Colour Files (*.lfc)

Perceptually uniform colourmaps are available at <http://peterkovesi.com/projects/colourmaps/>, where they can be downloaded in ERMapper (*.lut), Geosoft (*.tbl) and Golden Software Surfer (*.clr) format.

Colourmaps used in earlier versions of Leapfrog Geothermal can be downloaded from http://downloads.leapfrog3d.com/Colourmaps/older_leapfrog_gradients.zip.

Matplotlib colour gradients can be downloaded from http://downloads.leapfrog3d.com/Colourmaps/matplotlib_colour_gradients.zip.

Imported colour gradients are stored in the project tree in the **Colour Gradients** folder. To import a colour gradient right-click on the **Colour Gradients** folder and select **Import Gradient**. In the window that appears, navigate to the folder containing the gradient file and click **Open**. The gradient will be added to the **Colour Gradients** folder.

If you delete a colour gradient from the **Colour Gradients** folder and it is in use in the project, you will need to select a replacement gradient for all colourmaps that use that gradient. Select the replacement colour gradient from those available in the project:

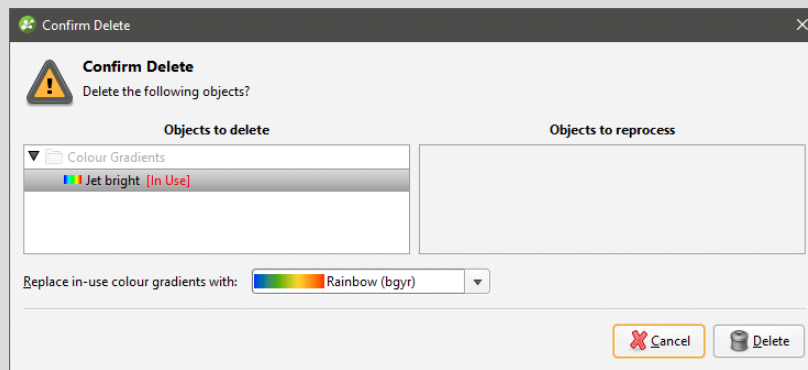

To edit the colourmap for an object, add the object to the scene. Click on the colourmap in the shape list and select **Edit Colourmaps**:

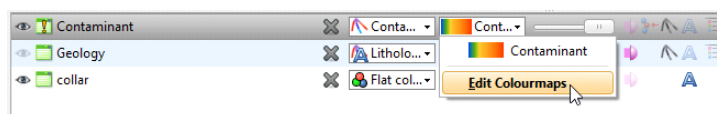

The **Edit Colourmaps** window will display the colourmap that is currently being used to display the data. The scene will be updated to reflect the changes you make in this window. To save the currently displayed colourmap and return to the main window, click **Close**.

Clicking **Revert All** deletes all custom colourmaps and cannot be undone.

Continuous Colourmaps

The **Gradient** list includes all inbuilt and imported gradients. This is the **Edit Colourmaps** window for editing continuous colourmaps, showing imported gradients from the **Colour Gradients** folder (top of the list) and the **Built-in Gradients**:

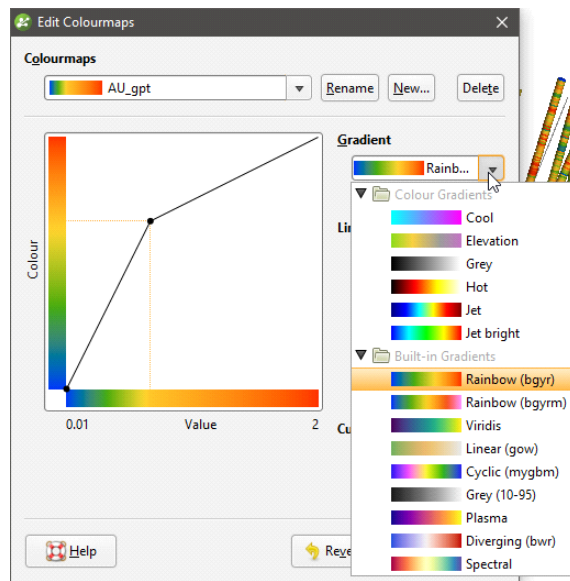

Once you have selected a gradient, you can change how it is used to display the data by adjusting the limits and the curve points.

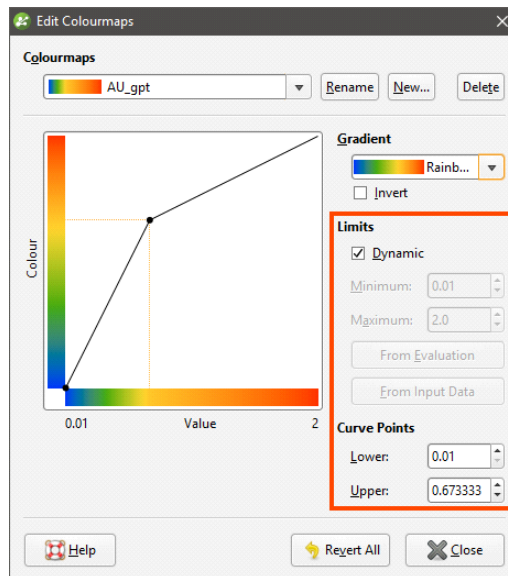

The values that lie outside the **Limits** are coloured with the last colour at the relevant end of the colourmap. If the **Dynamic** box is ticked, the gradient will be updated when the data is updated, such as when well data is appended. If the box is unticked, the values manually set for the

Minimum and **Maximum** limits will control the lower and upper bounds of the colourmap. Reducing the range of the upper and lower bounds is useful if the bulk of the data points have values in a range much smaller than the overall range of the data. This is common in skewed data.

The **From Input Data** button automatically adjusts the **Minimum** and **Maximum Limit** values so that the colourmap would follow the actual data distribution of the input data. The **From Evaluation** button appears for data columns that are part of tables produced from other data sources in the project. For example, a numeric data column that is part of a merged table will have the **From Evaluation** option. **From Input Data** uses all the data in the source data, whereas **From Evaluation** uses only the local data.

The transformation of the colourmap can be adjusted by dragging the dots:

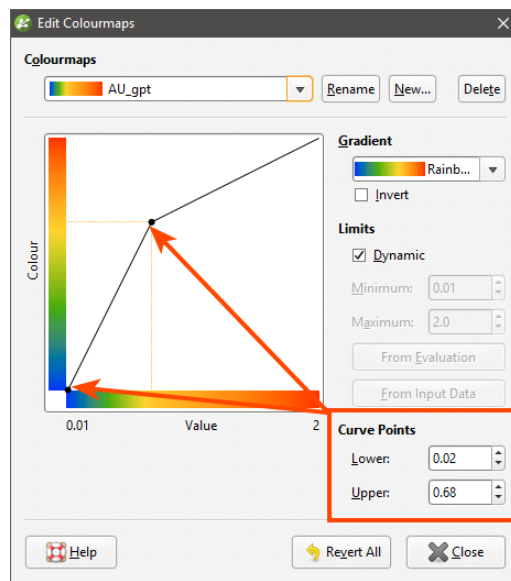

It can be helpful to view the histogram of the data when adjusting the curve points.

Both continuous and discrete colourmaps can be used to display date information. If a date is displayed using a continuous colourmap, the curve points represent the start and end dates:

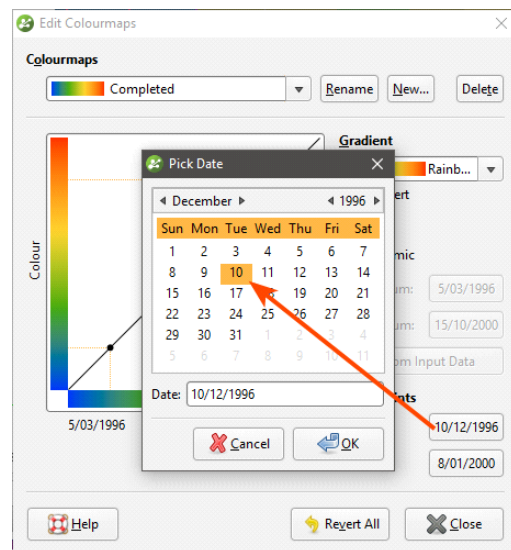

Discrete Colourmaps

With discrete colourmaps, the selected gradient can be used in generating intervals.

When you create a discrete colourmap, intervals are defined and applied to the data displayed in the scene:

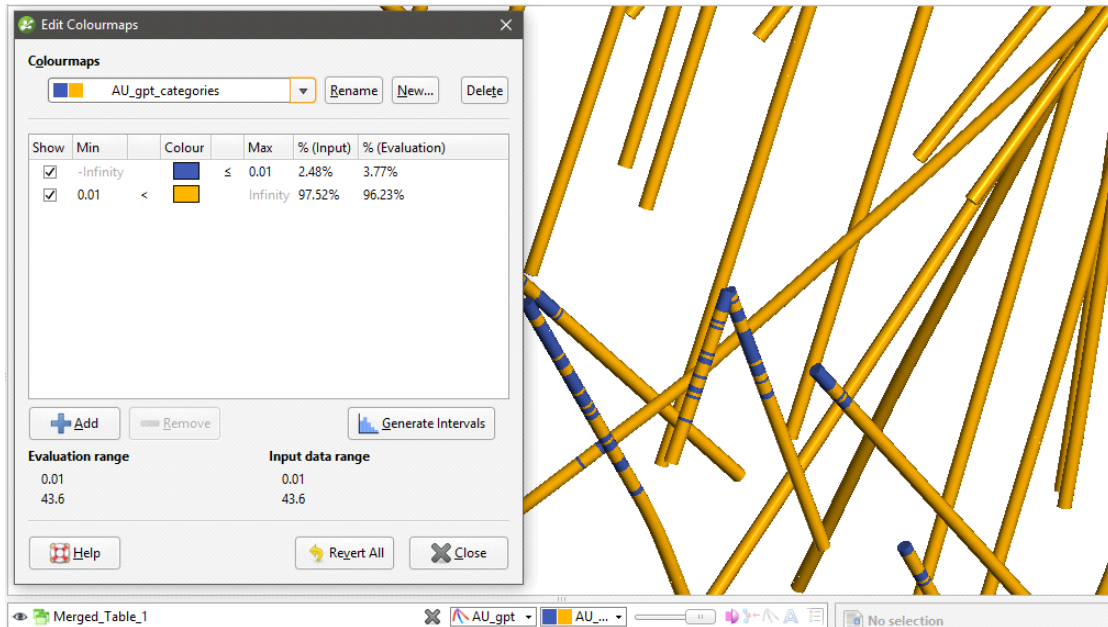

Click the **Generate Intervals** button to generate intervals based on various statistical methods:

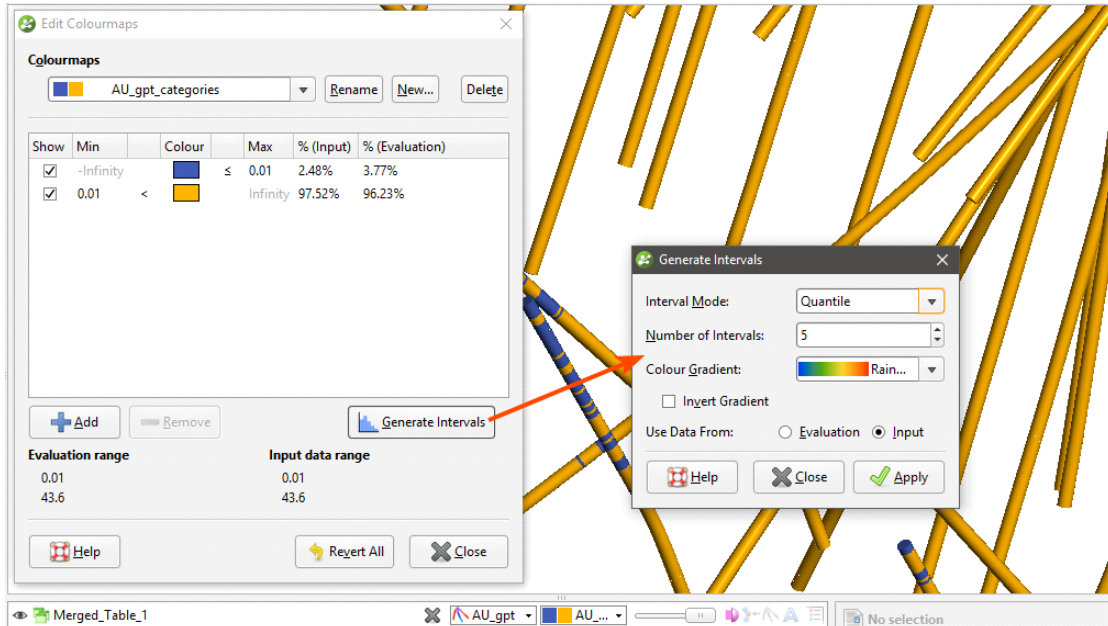

Select an **Interval Mode**. The options are:

- **Quantile**. This attempts to create the specified number of intervals so that each interval contains the same number of values.

- **Progressive.** This attempts to create intervals that enclose progressively smaller percentages of values. For example, 1000 unique values organised into 5 intervals would have the following percentiles: ~33%, ~27%, ~20%, ~13%, ~6%.
- **Progressive Double.** This is similar to **Progressive**, but is “steeper”. For example, 1000 values organised into 5 intervals would have the following percentiles: ~50%, ~25%, ~12.5%, ~6.25%, ~3%.
- **Equal Intervals.** This creates intervals at equal spacing across the range of the values.
- **Logarithmic Intervals.** This creates intervals at equal spacing, in log-space, across the range of values.
- **K Means Clustering.** This is an iterative algorithm that sorts values into clusters in which each value belongs to the cluster with the nearest mean. This option can take some time, especially with large datasets and a large number of intervals.

Set the **Number of Intervals** and the **Colour Gradient** to be used as the basis for the interval colourings.

The data used can be the **Input** data or the **Evaluation** data. The **Evaluation** option only appears for data columns that are part of tables produced from other data sources in the project. For example, a numeric data column that is part of a merged table will have the **Evaluation** option. The **Input** option uses all the data in the source data, whereas the **Evaluation** option uses only the local data.

The first interval is assigned the first colour of the selected colour gradient and the last interval is assigned the gradient’s last colour; selecting **Invert Gradient** swaps this around. Remaining intervals are assigned equally along the gradient.

Experiment with the different settings and click **Apply** to see the effects of changes:

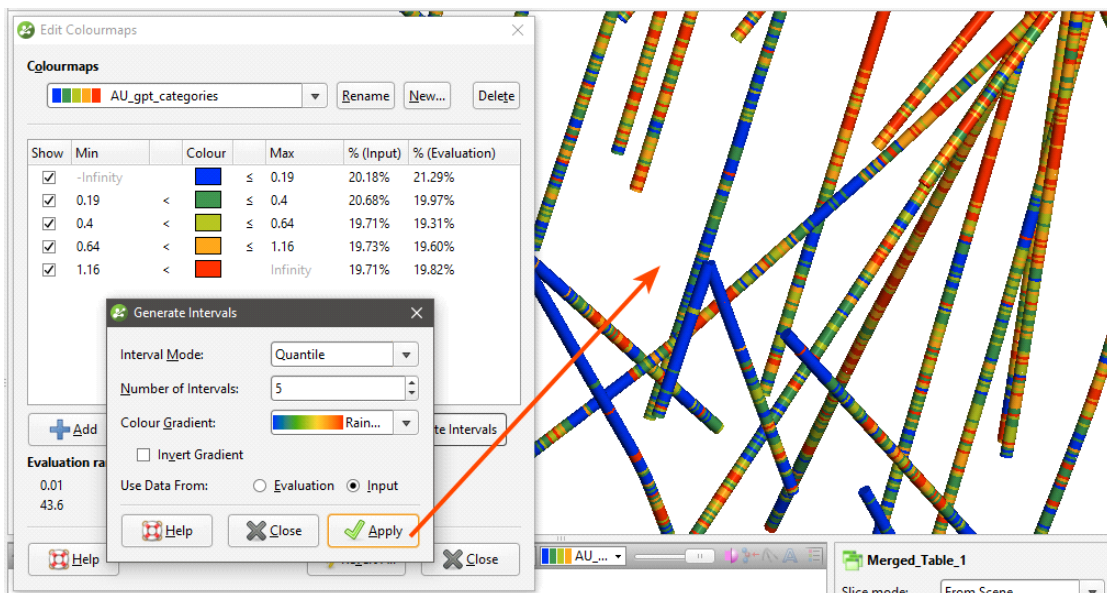

You can also add intervals manually by clicking the **Add** button. For example, if you create a discrete colourmap to show the different stages of a drilling campaign, the initial colourmap contains only two intervals:

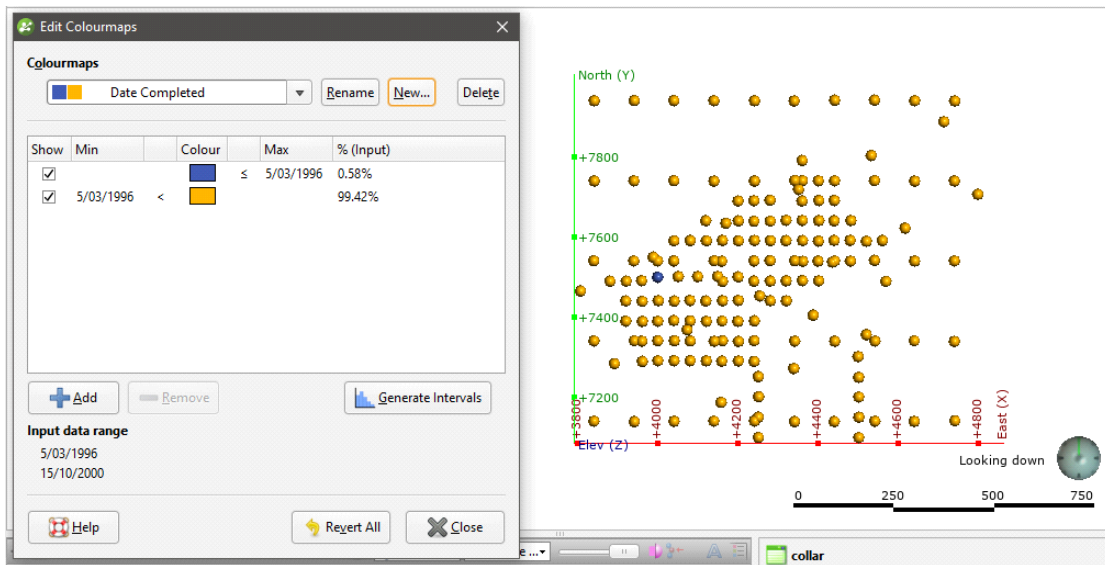

Click the **Add** button to add new intervals and use the **Min** and **Max** entries in the table to set the start and end points of each interval:

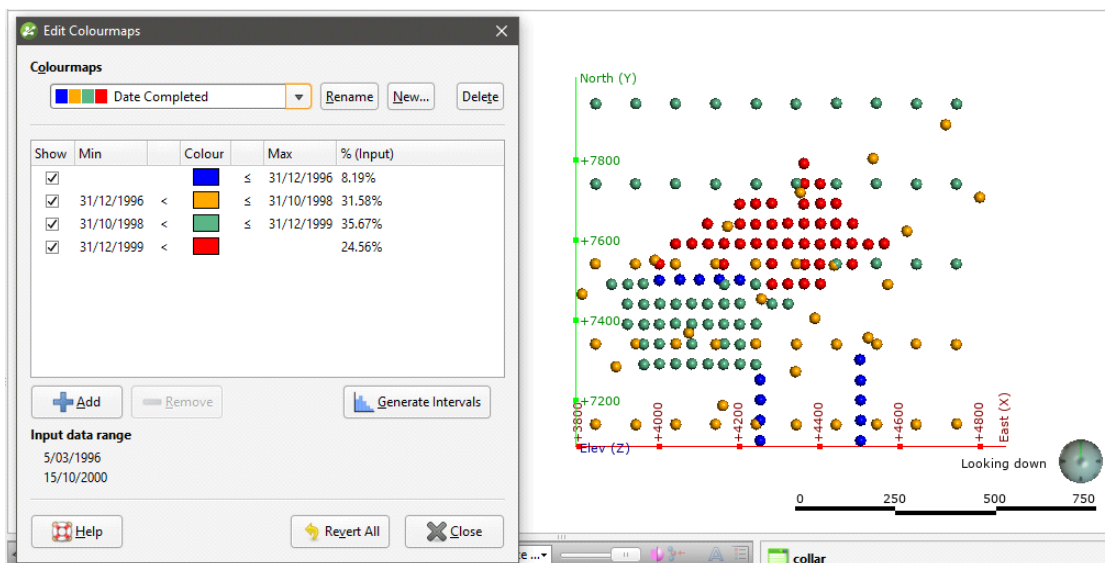

Opacity

The opacity slider in the shape list controls the transparency of objects in the scene:

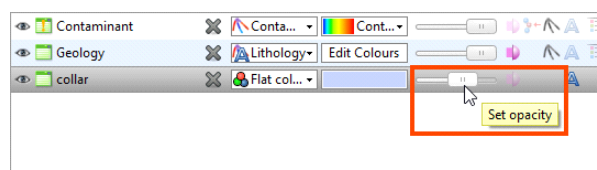

Property Buttons

The property buttons available in the shape list vary according to the type of object selected. For example, property buttons can show or hide the triangles on a mesh, render points as spheres or display a surface clipped to a model boundary. You can always find out what a button does by holding the cursor over the button:

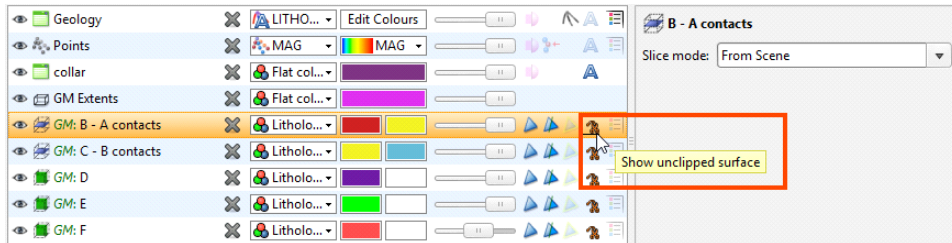

Legends

You can display a legend for many objects, including lithologies. To do this, click the legend button in the shape list:



To remove the legend from the scene, either click the legend button again or click the red X in the scene window:



Slice Mode

When an object is selected in the shape list, a **Slice mode** property is available in the properties panel. See [Object Slice Mode](#) for more information.

Filtering Data Using Queries

When a data table is selected in the shape list, you can use the controls in the shape properties panel to apply filters to the data in the scene. If query filters are available for the selected object, they will be listed in the **Query filter** list:

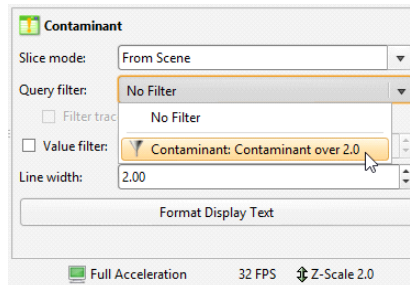

Filtering Data Using Values and Categories

In the shape properties panel, you can also filter the range of values displayed. Tick the **Value filter** box, then set the upper and lower limits of the range of data displayed:

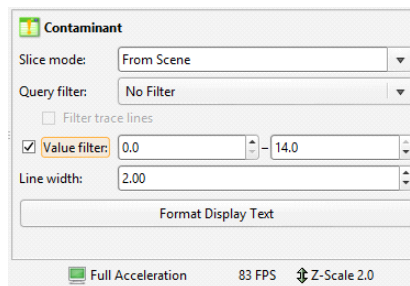

If the data includes date information, you can use the **Value filter** option to restrict the display to a range of dates.

Drawing in the Scene

In Leapfrog Geothermal, you can draw polylines to define many surfaces, including lateral extents and contact surfaces. You can also use polylines to make adjustments to surfaces and create new GIS lines.

This topic describes drawing polylines in Leapfrog Geothermal. It is divided into:

- [The Drawing Toolbar](#)
- [Drawing Hotkeys](#)
- [Drawing 3D Lines](#)
- [Drawing 2D Lines](#)
- [Polyline Properties](#)
- [Tangents and Ribbons](#)
- [Drawing Points](#)
- [Editing Normals](#)

For information on importing and exporting polylines, see [Polylines](#).

When drawing in Leapfrog Geothermal, you can draw on surfaces or on the slicer.

- If you are drawing on surfaces, the line will be in 3D.
- If you are drawing on the slicer, the line will be in 2D and locked to the plane it was drawn in. It can be converted to a 3D line.

When you start drawing a polyline, drawing tools are added to the scene window. If you are drawing a GIS line or if the slicer was already in the scene, the drawing mode will be set to be on the slicer. Toggle between the two options using the toolbar buttons:

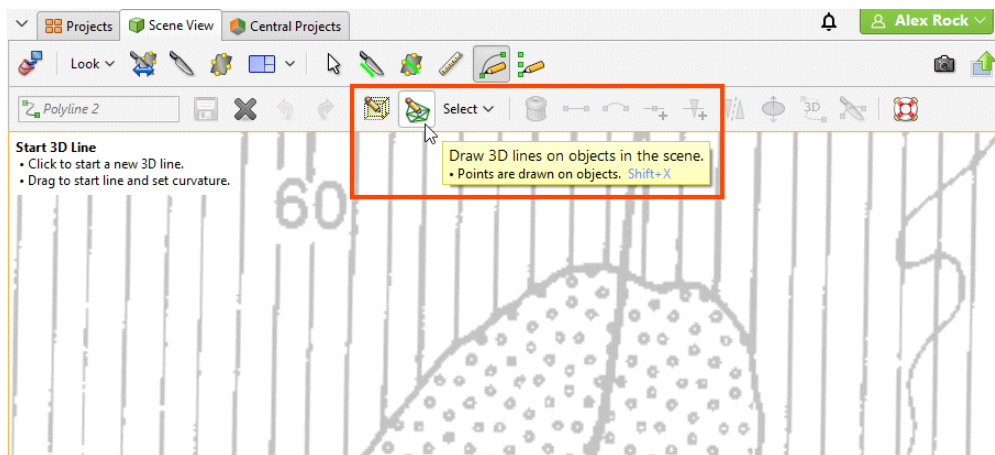

When drawing and otherwise working with the polyline, tooltips are displayed in the scene that show what actions are currently possible:

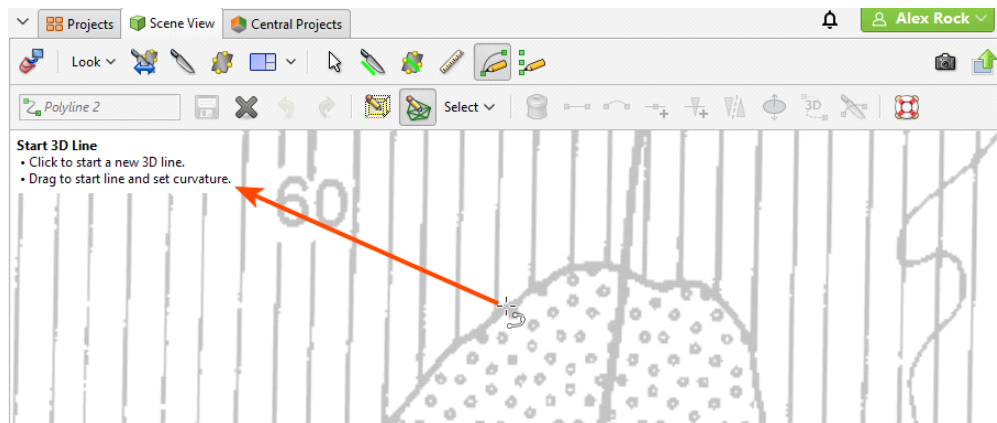

For example, if the drawing mode is set to on slicer (🔪), you will be warned if the slicer is not in the scene:

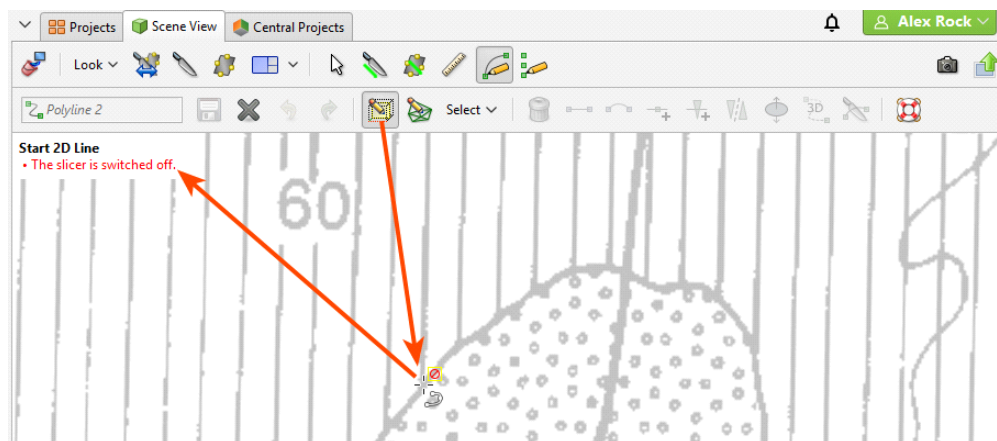

You can disable these tooltips once you are more familiar with how the polyline tool works. Open the **Settings** window by clicking on the **Leapfrog Geothermal** menu and selecting **Settings**. Click on **Overlays** and disable the **Polyline help text** option.

The Drawing Toolbar

The **Draw lines** (📏) and **Draw points** (📍) tools are used to create new lines and points. The tools in the second row are for controlling whether the polyline is drawn (on the slicer (🔪) or on surfaces (📏)). The **Select** list lets you select different parts of the polyline.

The other tools are for working with selected parts of the polyline:

- Making line segments straight (📏) or curved (📏)
- Adding nodes (📍) to lines
- Adding tangents to lines or reorienting selected tangents (📏)
- Flipping selected tangents and disks (📏)

- Add disks to points (📍)
- Converting a 2D polyline to 3D (📏)
- Setting the slicer to a 2D polyline (🔪)

There are also buttons for undoing (↶) and redoing actions (↷), as well as saving the polyline (💾) or deleting selected parts of it (🗑️).

Drawing Hotkeys

Use the following keyboard shortcuts while drawing:

Key(s)	Action
Ctrl+5	Draw lines (📏)
Ctrl+6	Draw points/disks (📍)
Ctrl+S	Save (💾)
Ctrl+W	Close editor (✖)
Ctrl+Z	Undo (↶)
Ctrl+Y	Redo (↷)
Delete	Delete the selected segment, node, tangent or disk (🗑️)
X	Draw/move on slicer (🔪)
Shift+X	Draw/move on objects (📏)
Q	Make segments curved (↩)
Shift+Q	Make segments straight (↪)
Shift-A	Add node (📍)
A	Add/reorient tangent (📏)
V	Flip tangent/disks (📏)
Shift+D	Add/remove disk (📍)
Shift+E	Make selected line 3D (📏)
Shift+W	Set slicer to selected 2D line (🔪)
Ctrl+A	Select all
Shift+Ctrl+Alt+L	Select all lines
Shift+Ctrl+Alt+T	Select all tangents
Shift+Ctrl+Alt+P	Select all points without disks
Shift+Ctrl+Alt+D	Select all points with disks

Drawing 3D Lines

Polylines are made up of nodes, which are added where you click in the scene using the **Draw lines** (🎨) tool. This is a 3D polyline, which is indicated in the scene by the dashed line:

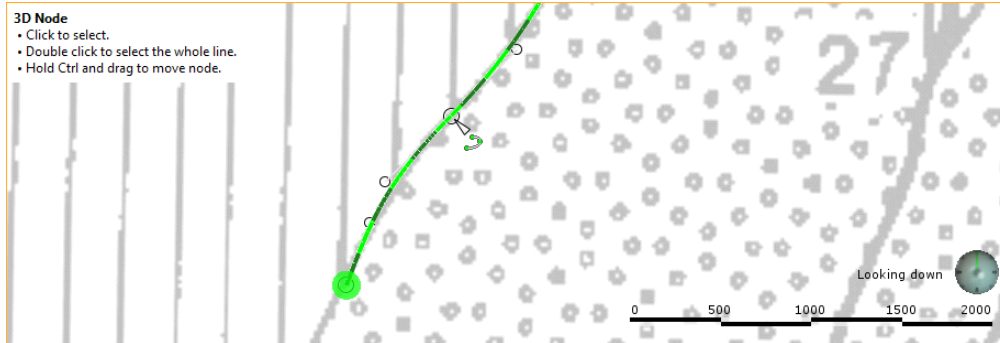

Click to select a node and drag to move it in the scene parallel to the screen. If you hold down the Ctrl key while moving the node, it will snap onto surfaces in the scene.

When well segments are in the scene, the polyline tool will snap to the end of nearby intervals.

When you click to add a node, dragging the mouse before releasing the button lets you control the curvature:

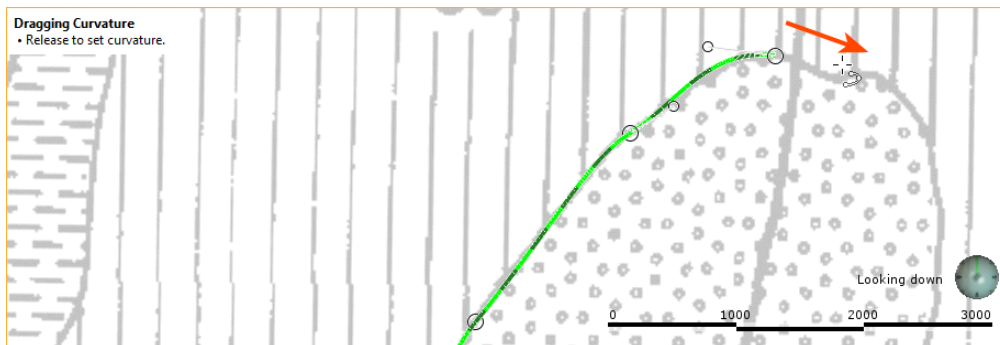

When you start drawing a polyline, a tangent is automatically added to the first node. This is oriented in the direction of the camera, and you will need to rotate the scene to see that it is a cone.

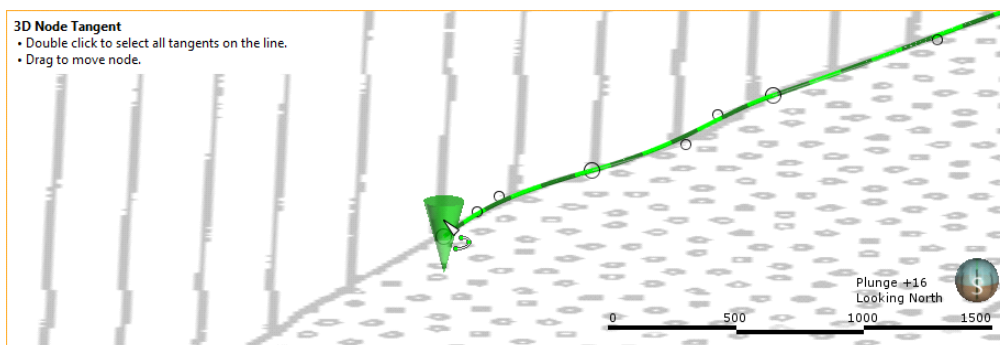

You can hide the tangent cones in the scene, if it makes drawing difficult. To do this, click on the polyline in the shape list and disable the **Show tangent cones** option:

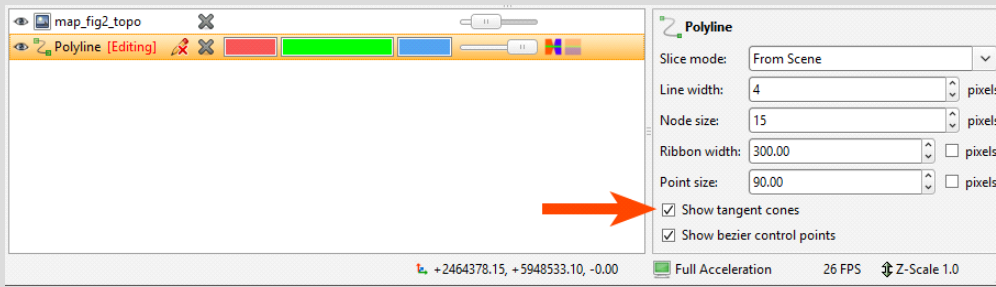

There are also bezier control points for curved segments. Bezier control points are used to control the curvature of the segment. Click on a control point and drag it to change the curve of the segment:

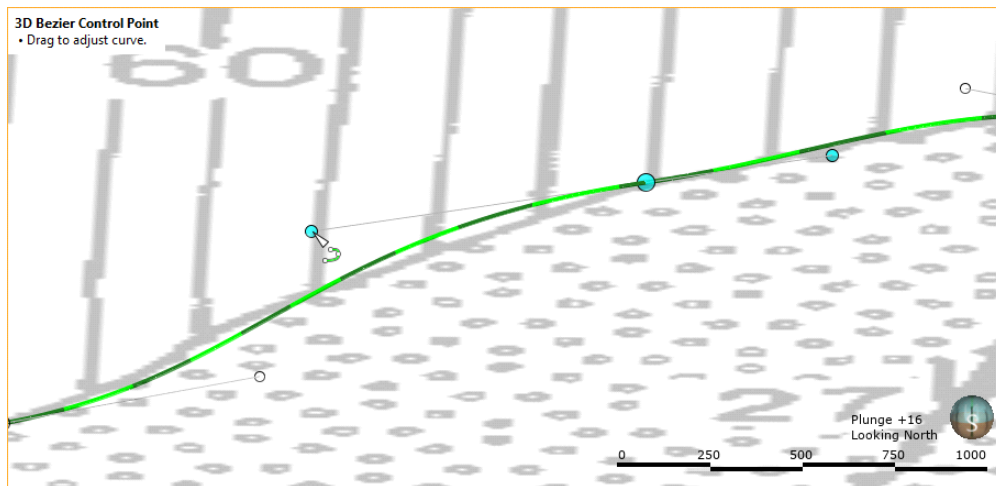

If you can't see the bezier control points, click on the polyline in the shape list and enable the **Show bezier control points** option:

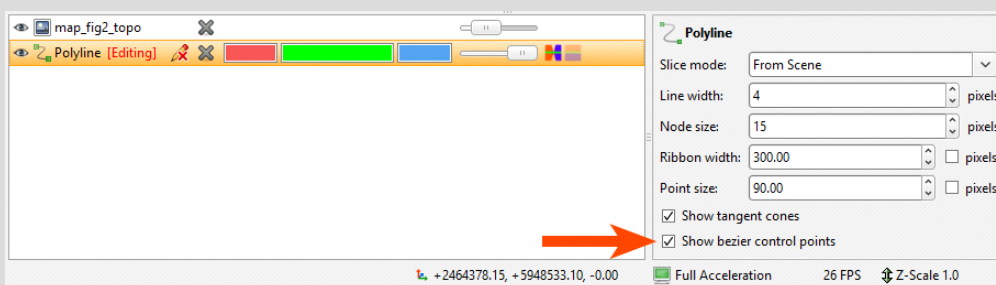

When you have finished drawing, right-click to end the polyline. Switch to the **Select** tool (🖱️) to make changes to the polyline.

- Click on a node to move it.
- Click on a segment away from a node and drag it to change its curvature.
- Click on one or more segments, then make them straight (↔️) or curved (↪️).

- Select a point on the polyline, then click (📍) to add a node.
- Select a point on the polyline. The point selected is indicated in the scene by a red cone. You can then click (📍) to add a tangent oriented in the direction of the camera.
- Select a tangent and click (📍) to change the orientation of the segment to that of the camera.
- Select a tangent and click (📍) to flip it.

Begin drawing again by selecting the **Draw lines** button (🖌️). To continue from an existing node at the start or end of a polyline, click on the node.

Although you can make the line curved while adding nodes, an easy way to draw a curved polyline is to simply click to add a series of points. Set the curvature of the whole line by selecting all segments and then clicking the **Make selected segments curved** button (📐):

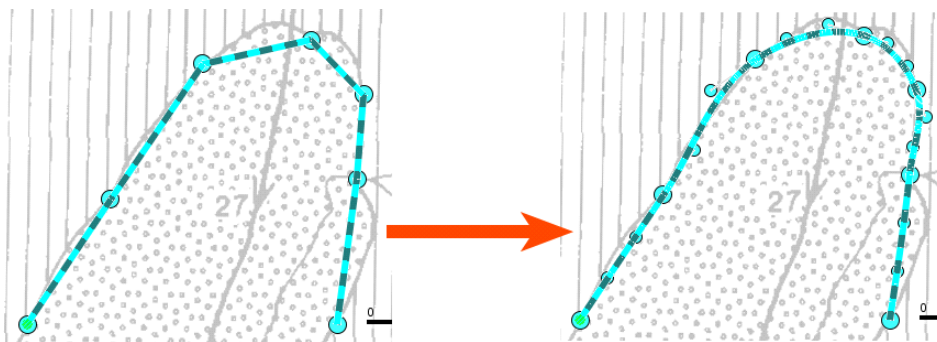

You can then make any adjustments to the curves required by dragging the segments or using the bezier control points.

Drawing 2D Lines

Working with a 2D polyline is similar to working with a 3D polyline, except that drawing is restricted to the 2D plane set by the slicer. A 2D polyline is indicated in the scene by an unbroken line:

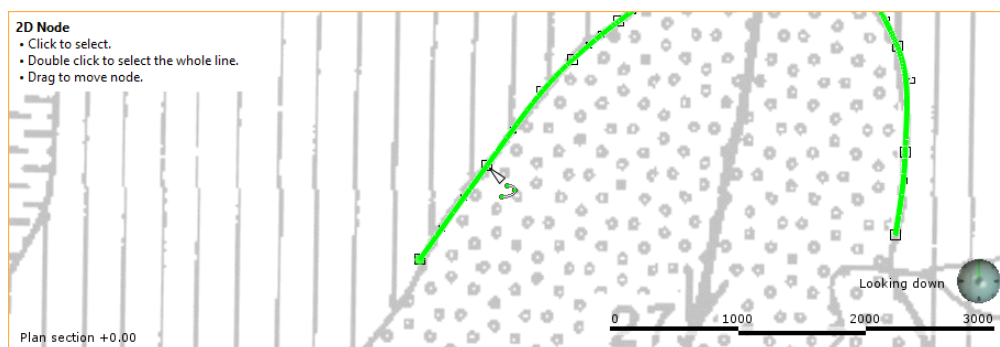

To convert a 2D polyline into a 3D polyline, click the 3D polyline button (📍).

Polyline Properties

In the shape list, you can control the colour of the positive (red) and negative (blue) surfaces of the line and of the line itself (green):

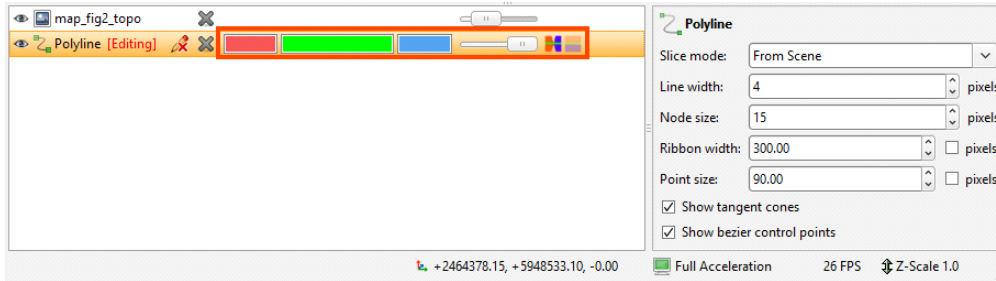

For contact surfaces, the colour of the positive and negative sides of a ribbon will be determined by the lithologies or categories assigned to either side of the surface.

With the controls in the properties panel, you can change the size of different parts of the polyline to make working with the polyline easier.

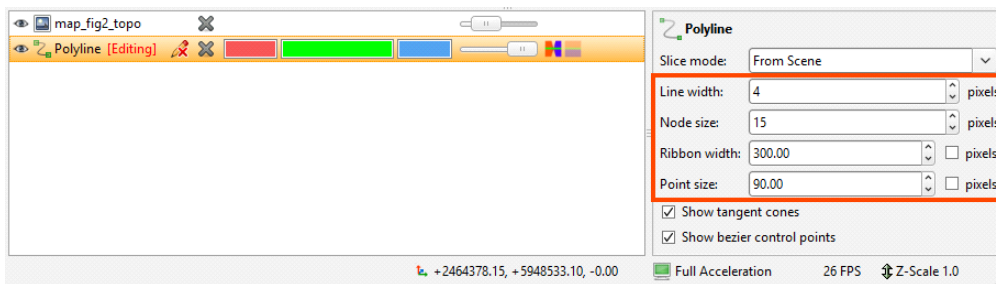

For **Ribbon width** and **Point size**, the setting is, by default, in pixels, but both can be displayed in real-world size, which may make editing the polyline easier in some circumstances.

You can also choose whether or not to show tangent cones and bezier control points.

Tangents and Ribbons

The **Surface ribbon** (🚩) and **Normal ribbon** (🚩) help you to determine the orientation of the polyline in the scene. The surface ribbon reflects the orientation of the polyline and the normal ribbon is perpendicular to the surface ribbon.

For example, click on the **Surface ribbon** button (🌈) to determine which side of the polyline is positive (red) and which side is negative (blue):

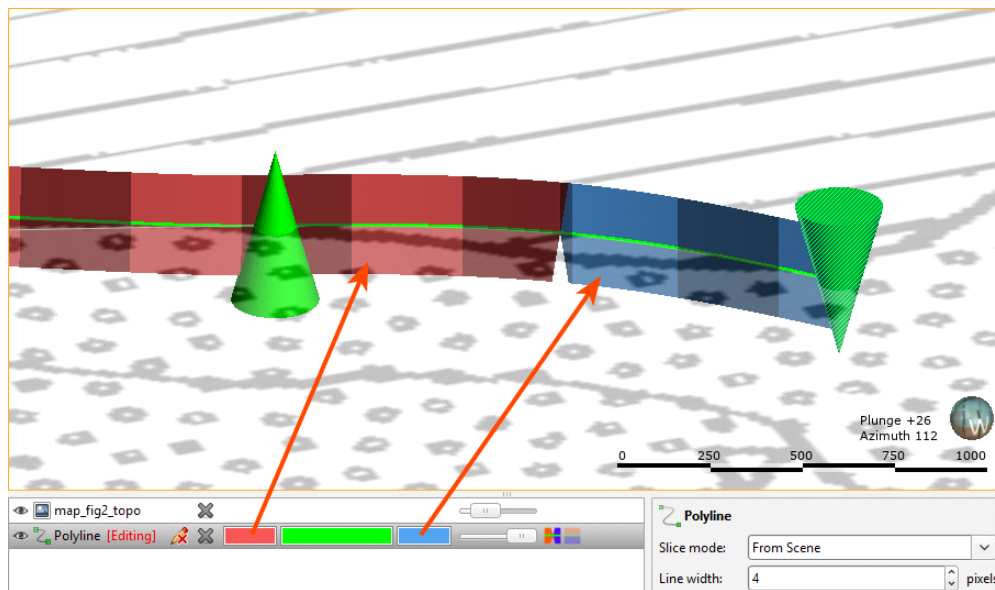

If you are having trouble seeing the ribbons, you can change their size using the **Ribbon width** control in the properties panel.

When you first draw a polyline, it has only one tangent, located at the first node and oriented in the direction of the camera. You can add more nodes by clicking at a point along the polyline and then clicking the **Tangent** button (⊕). A tangent is added to the polyline, which is updated to reflect the new information. The tangent's orientation is taken from the camera angle. To reorient a tangent, click on it in the scene, change the camera angle to reflect the orientation you wish to set, then click the **Tangent** button (⊕).

You can also flip selected tangents by clicking on the **Flip tangents and disks** button (🔄).

You can add as many tangents as required, although it is best to keep them to a minimum.

Drawing Points

Polylines can also include points, which are drawn using the **Draw points** tool (📍). Clicking adds a point, and clicking and dragging adds a point with a normal:

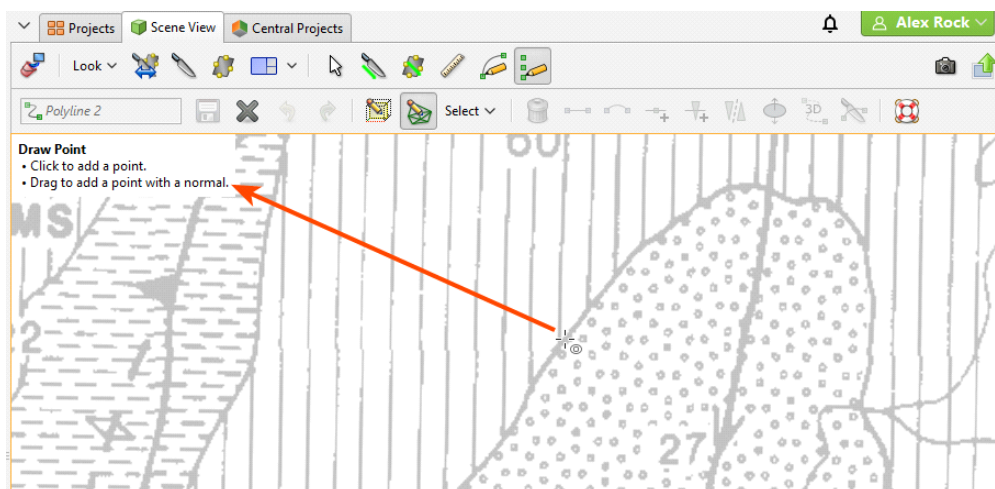

Normals are shown in the scene as disks intersecting the points.

The scene below shows one point with a normal and one without:

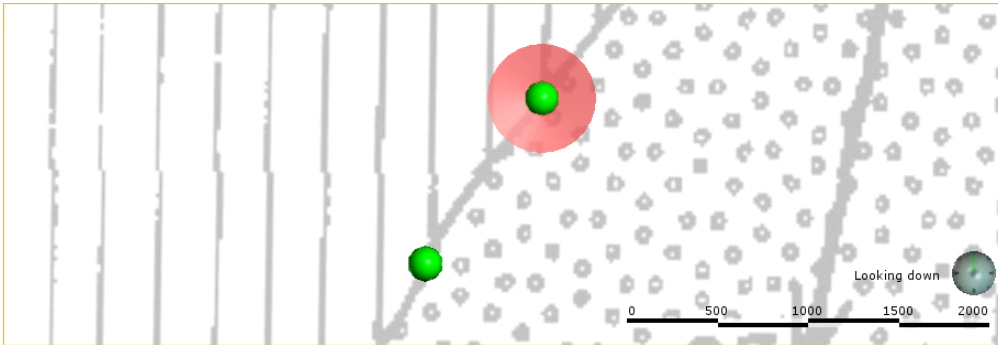

To move a point without a normal, switch to the **Select** tool (⏏). Click on the point and drag it. To add a normal to the point, click on it in the scene and click the **Add disk** button (⊕).

Editing Normals

To edit the orientation of a point with a normal, click on it in the scene. There are two rotation modes. In the first, the handles adjust the dip and azimuth of the disk:

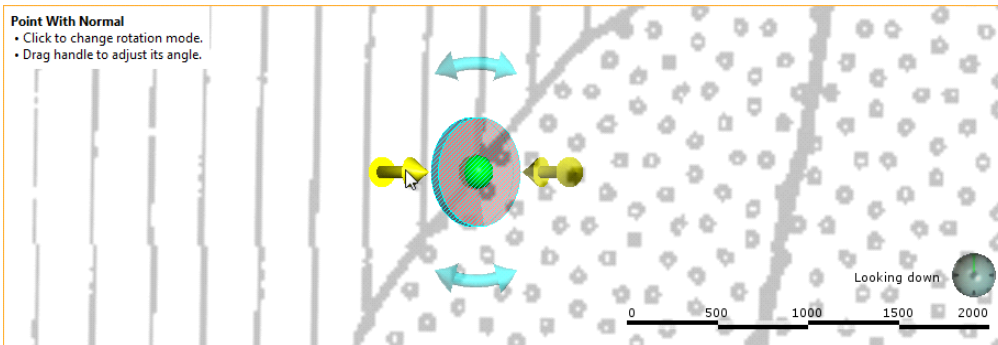

Click on the disk to change the rotation mode.

In the second rotation mode, dragging the disk rotates it in the plane indicated by the handles:

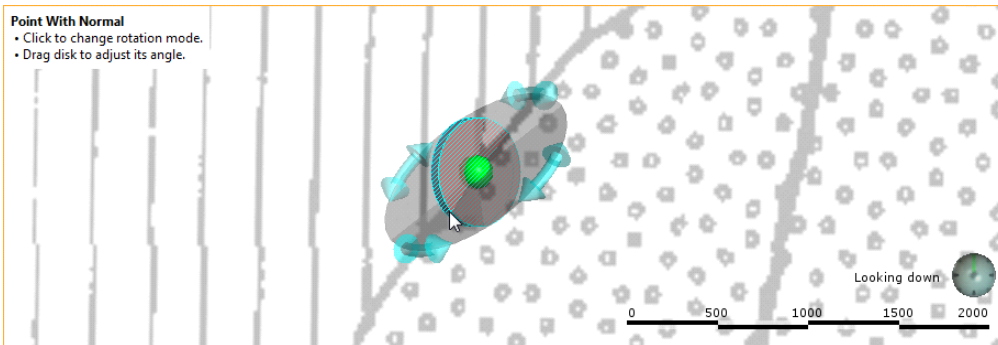

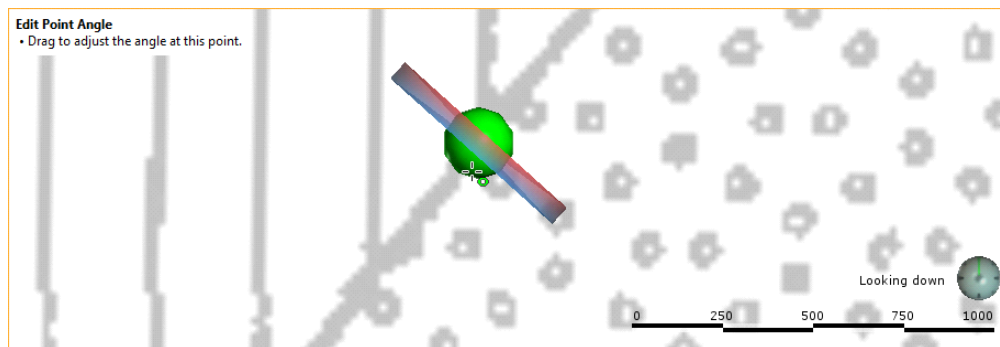

Change the angle of the plane by moving the mouse cursor over the disk.

You can also change the orientation of a disk by drawing over it. To do this, make sure the **Draw points** tool () is selected. Hold the cursor over the point you want to edit. The cursor will turn green to indicate that you can adjust the disk's angle:

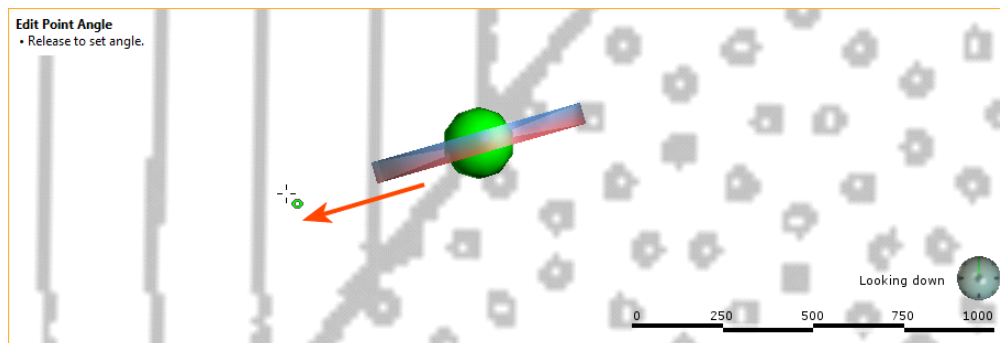

Drag to adjust the angle and release the mouse button when finished:



You can also flip selected disks by clicking on the **Flip tangents and disks** button ()

Organising Your Workspace

You can split the Leapfrog Geothermal main window into separate parts to make better use of your screen space. In addition, some Leapfrog Geothermal windows open in separate tabs that can be used either docked or detached. This topic describes how to change the main window to make the best use of your screen space. It is divided into:

- [Detaching Tabs](#)
- [Detaching and Minimising the Project Tree](#)
- [Organising the Scene View Tab](#)

Detaching Tabs

To detach a tab, either:

- Click on it and drag it away from the main window.
- Right-click on it and select **Move to New Window**.

You can then move and resize the detached tab.

To dock a detached tab, click on it and drag it to where you want to dock it:

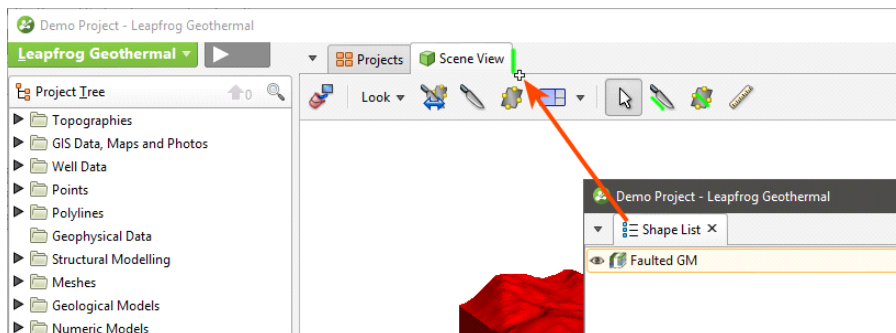

When the plus sign appears, release the mouse and the tab will dock.

Tabs can be docked to the main window or to other tabs. Drag tabs to reorder them.

You can view a list of all open tabs by clicking the down arrow to the right of the processing queue button:

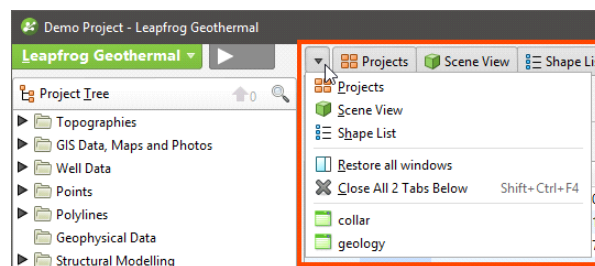

When you close a project, the position of open tabs will be saved and restored when the project is next opened.

For Leapfrog Geothermal windows that open in separate tabs, the position in which tabs open is determined by the **New tab position** setting in the **Settings** window:

- Open all tabs in the main window.
- Open all tabs in separate windows.
- Tabs can open where the last tab was moved to. This setting can be used for creating a window in which all tables and dockable windows open, with the scene window, project tree and shape list in another window.

To change this setting, click on the **Leapfrog Geothermal** menu, select **Settings** and then click on the **User Interface** tab.

Detaching and Minimising the Project Tree

The project tree can also be detached from the main window. To do this, right-click at the top of the project tree and select **Detach**:

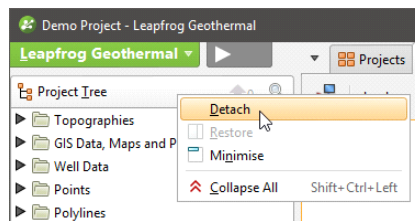

To reattach the project tree, click the red X to close the tab. It will reappear docked to the main window.

You can also minimise the project tree. To do this, right-click on it and choose **Minimise** or press the F8 key. Restore the project tree by clicking the button:

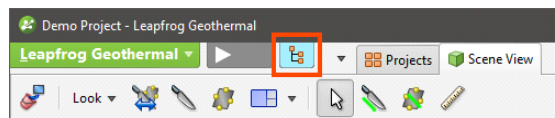

Pressing the F8 key once again also restores the project tree.

Organising the Scene View Tab

The **Scene View** tab is made up of the scene window, the shape list and the shape properties panel. The shape list and shape properties panel can be displayed on the right-hand side of the scene rather than below the scene. To do this, right-click in the shape list and select **Move List to Right**:

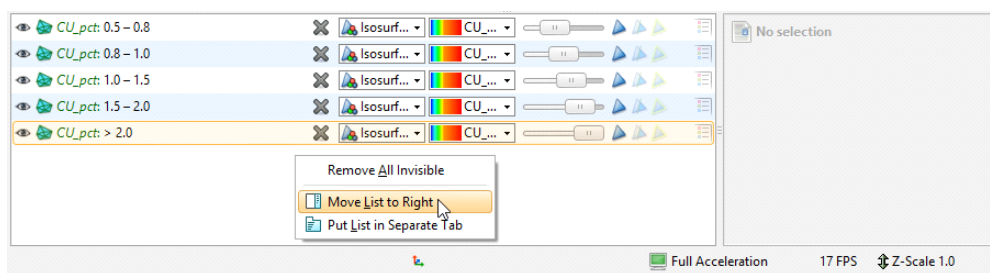

You can also detach the shape list and display it as a tab, which can then be detached from the main window. To do this, right-click in the shape list and select **Put List in Separate Tab**:

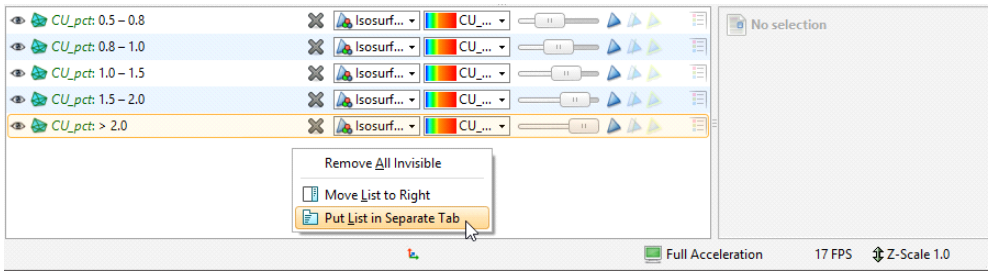

You can then detach the tab from the main window:

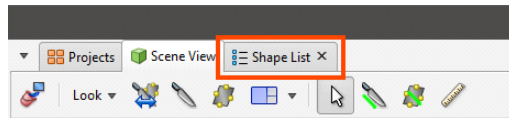

To dock the shape list to the **Scene View** tab, right-click in the **Shape List** tab and choose where you wish to dock the list:

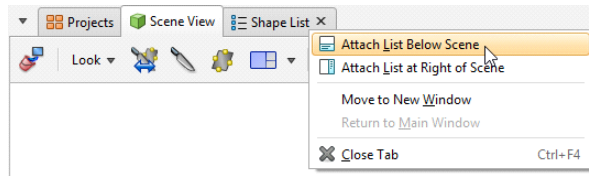

Interpolant Functions

Leapfrog Geothermal's powerful 3D interpolation engine can interpolate any numeric data (e.g. ore grade or piezometric head measurements) to describe how a real, numerical quantity varies in three dimensional space. Interpolation produces an estimate or "interpolated value" of a quantity that is not known at a point of interest but is known at other points.

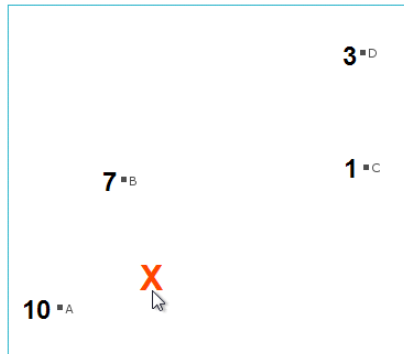

The simplest way to estimate values is to take the average of known values. Using this method, estimated values are the same everywhere, regardless of the distance from known data. However, this is not ideal as it is reasonable to assume that an estimated value will be more heavily influenced by nearby known values than by those that are further away. The estimates for unknown points when varying the distance from known point values is controlled by the interpolant function. Any interpolation function and the various parameters that can be set for each will produce a model that fits all the known values, but they will produce different estimates for the unknown points. It is important to select interpolation functions and parameters that make geologic sense. It may be necessary to identify a location that models predict differently, and plan wells to identify the best fit option.

Leapfrog Geothermal uses two main interpolant functions: the spheroidal interpolant function and the linear interpolant function. See [The Spheroidal Interpolant Function](#) and [The Linear Interpolant Function](#) for more information.

The Spheroidal Interpolant Function

In common cases, including when modelling most metallic ores, there is a finite range beyond which the influence of the data should fall to zero. The spheroidal interpolant function can be used when modelling in these cases.

The spheroidal interpolant function closely resembles a spherical variogram, which has a fixed range beyond which the value is the constant sill. Similarly, the spheroidal interpolant function flattens out when the distance from X is greater than a defined distance, the range. At the range, the function value is 96% of the sill with no nugget, and beyond the range the function asymptotically approaches the sill. The chart below labels the y-axis interpolant. A high value on this axis represents a greater uncertainty relating to the known value, given its distance from X. Another way to think of this is that higher values on this axis represent a decreasing weight given to the known value.

Known values within the range are weighted proportionally to the distance from X. Known values further from X than the range will all be given approximately the same weight, and have

about the same influence on the unknown value. Here, points A and B are near X and so have the greatest influence on the estimated value of point X. Points C and D, however, are outside the range, which puts them on the flat part of the spheroidal interpolant curve; they have roughly the same influence on the value of X, and both have significantly less influence than A or B:

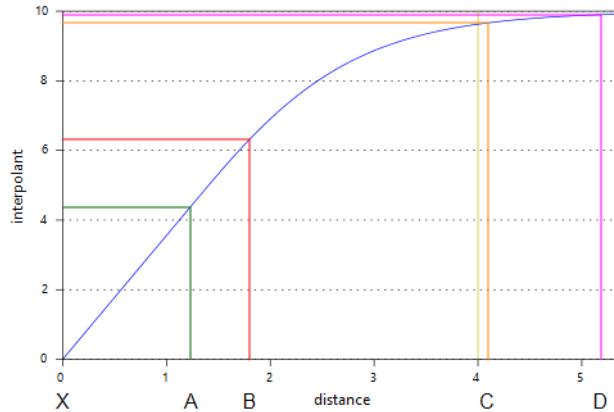

The rest of this topic describes the parameters used to define a spheroidal interpolant. These parameters are **Total Sill**, **Nugget**, **Nugget to Total Sill Ratio**, **Base Range**, **Alpha**, **Drift** and **Accuracy**.

To edit the parameters for an interpolant, double-click on the interpolant in the project tree and click on the **Interpolant** tab. The graph on the tab shows how the interpolant function values vary with distance and is updated as you change interpolant parameters:

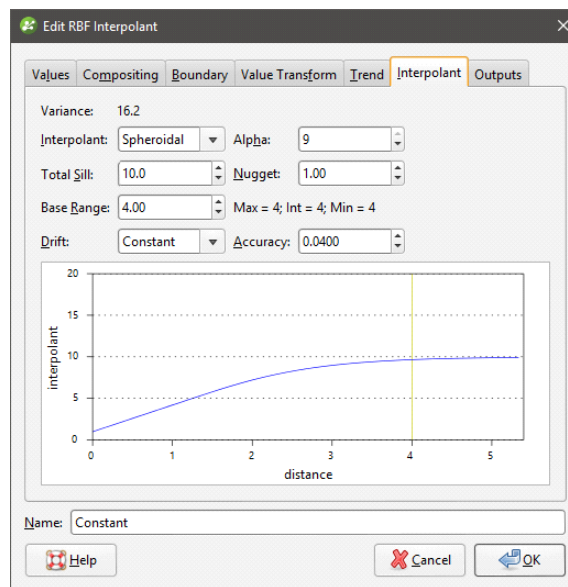

The yellow line indicates the **Base Range**. For this interpolant, the value of the interpolant is offset by the value of **Nugget**.

Total Sill

The **Total Sill** defines the upper limit of the spheroidal interpolant function, where there ceases to be any correlation between values. A spherical variogram reaches the sill at the range and

stays there for increasing distances beyond the range. A spheroidal interpolant approaches the sill near the range, and approaches it asymptotically for increasing distances beyond the range. The distinction is insignificant.

Nugget

The **Nugget** represents a local anomaly in sampled values, one that is substantially different from what would be predicted at that point, based on the surrounding data. Increasing the value of **Nugget** effectively places more emphasis on the average values of surrounding samples and less on the actual data point, and can be used to reduce noise caused by inaccurately measured samples.

Nugget to Total Sill Ratio

It is the **Nugget** to **Total Sill** ratio that determines the shape of the interpolant function. Multiplying both these parameters by the same constant will result in an identical interpolant. Here, the interpolant on the left has a nugget of 3 and a sill of 10; the one on the right has a nugget of 9 and a sill of 30. Note that because the nugget and sill have been increased by the same factor, the function has the same shape.

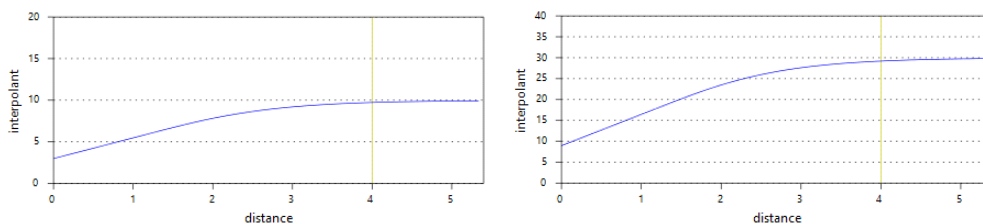

Base Range

The **Base Range** is the distance at which the interpolant value is 96% of the **Total Sill**, with no **Nugget**. The **Base Range** should be set to a distance that is not significantly less or greater than the distance between wells, so it can reach between them. As a rule of thumb, it may be set to approximately twice the average distance between wells.

Here the effect of different range settings on the value of X is demonstrated using our trivial example of four wells:

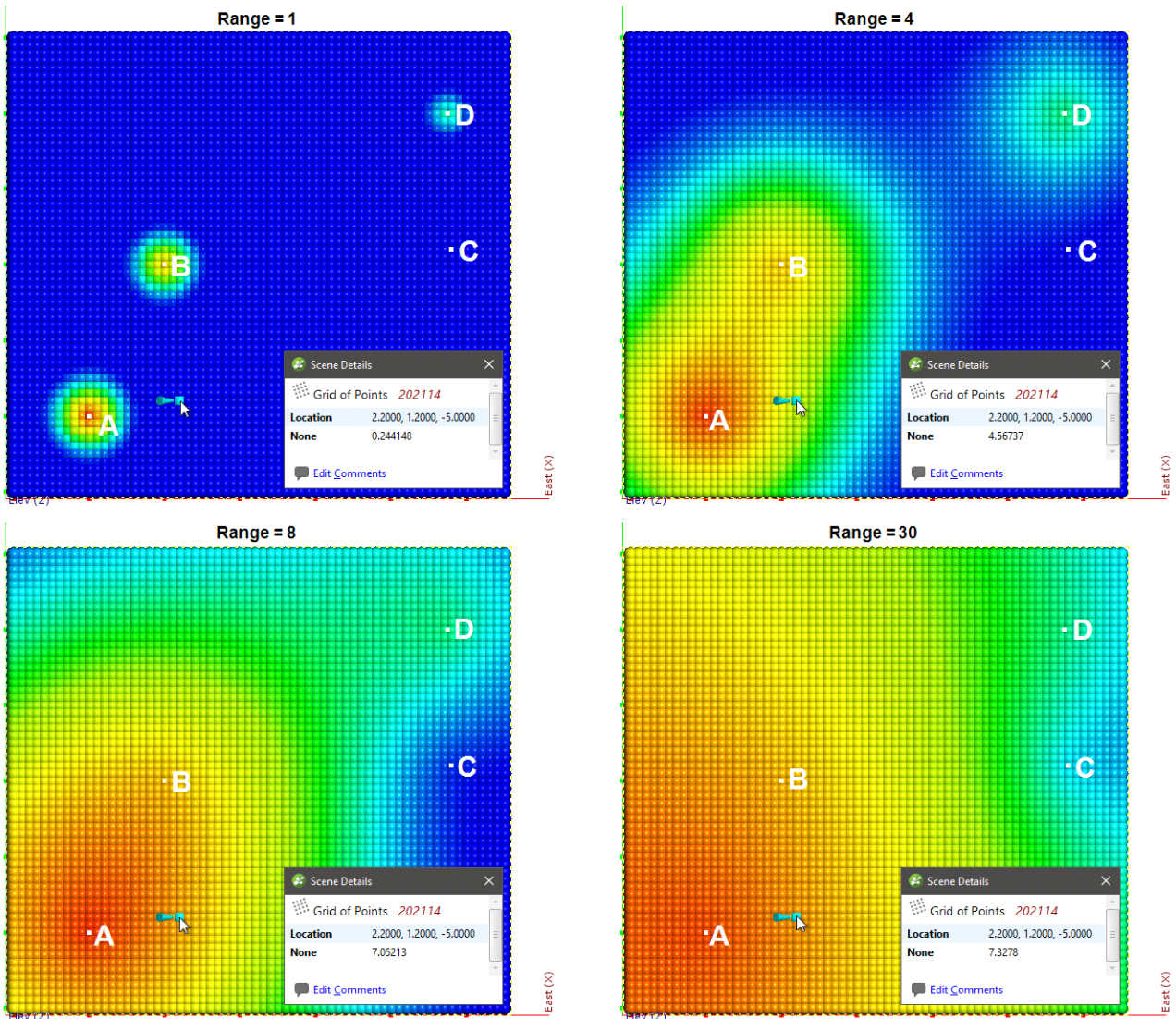

When the range is set to 1, it is too small to describe any real effect between wells. When the range is set to 30, distant wells have more influence, increasing the spatial continuity. Also illustrated is the range set to approximately the average distance between wells (range = 4) and the range set to about twice the average distance between wells (range = 8). Of these, the range set to 8 might be the best choice.

Alpha

The **Alpha** constant determines how steeply the interpolant rises toward the **Total Sill**. A low **Alpha** value will produce an interpolant function that rises more steeply than a high **Alpha** value. A high **Alpha** value gives points at intermediate distances more weighting, compared to lower **Alpha** values. This figure charts an interpolant function for each alpha setting, using a nugget of 8, sill of 28, and range of 5000. A spherical variogram function is included for comparative purposes. The inset provides a detailed view near the intersection of the sill and range.

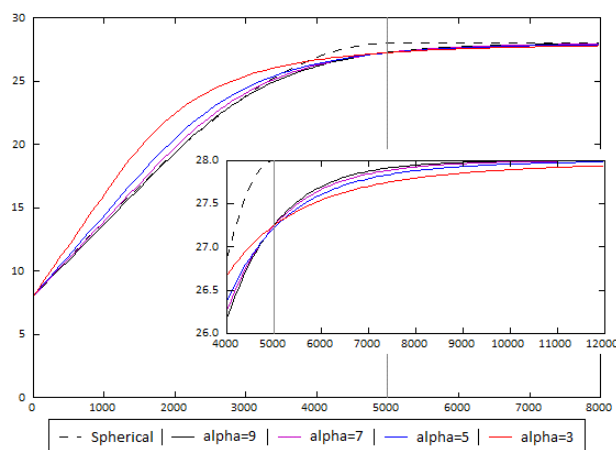

An alpha of 9 provides the curve that is closest in shape to a spherical variogram. In ideal situations, it would probably be the first choice; however, high alpha values require more computation and processing time, as more complex approximation calculations are required. A smaller value for alpha will result in shorter times to evaluate the interpolant.

The following demonstrates the difference between alpha = 3 and alpha = 9:

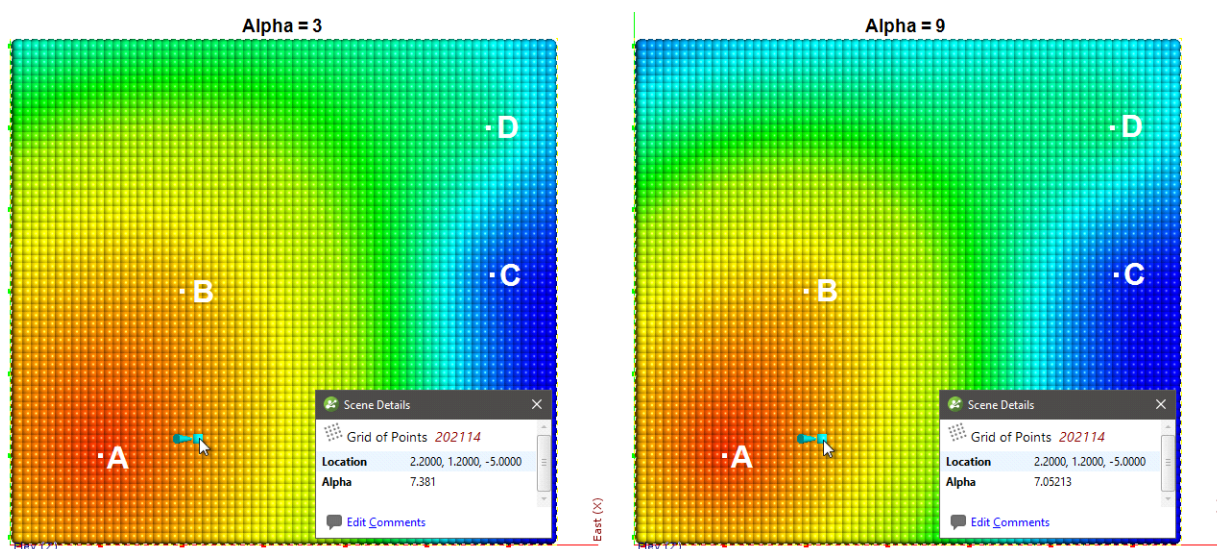

There is a measurable difference between the estimates at the point being examined, but for many purposes, using a lower alpha will result in satisfactory estimates and reduced processing time.

Drift

The **Drift** is a model of the value distribution away from data. It determines the behaviour a long way from sampled data.

- **Constant:** The interpolant goes to the approximated declustered mean of the data.
- **Linear:** The interpolant behaves linearly away from data, which may result in negative values.
- **None:** The interpolant pulls down to zero away from data.

Here, the three **Drift** options for the interpolant are shown evaluated on grids:

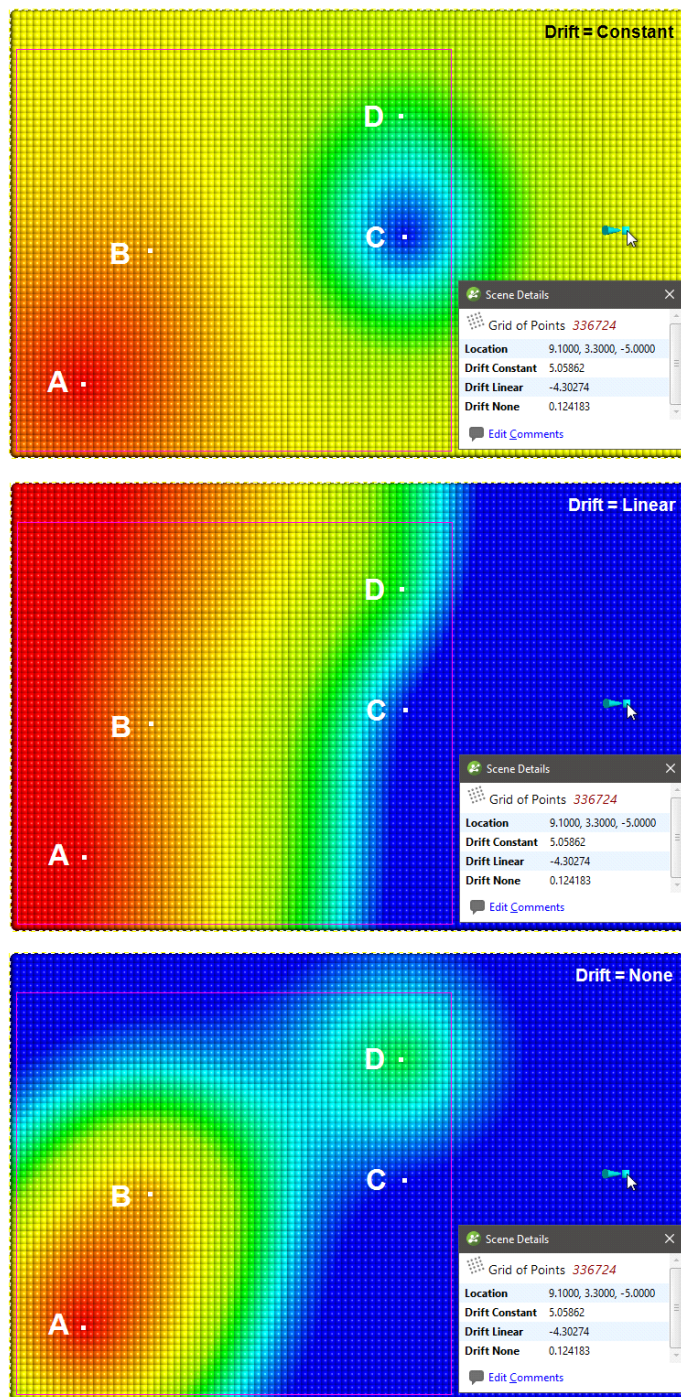

In this example, the boundary is larger than the extent of the data to illustrate the effect of different **Drift** settings.

Away from the data, the value of the interpolant when **Drift** is **Constant** and **Linear** is not reasonable in this case, given the distance from the data. The low value when **Drift** is **None** is more realistic, given the distance from the data.

If when using the spheroidal interpolant you get a grade shell that fills the model extents, it is likely that the mean value of the data is higher than the threshold chosen for the grade shell in question. If this occurs, try setting the **Drift** to **None**.

Accuracy

Leapfrog Geothermal estimates the **Accuracy** from the data values by taking a fraction of the smallest difference between measured data values. Although there is the temptation to set the **Accuracy** as low as possible, there is little point to specifying an **Accuracy** significantly smaller than the errors in the measured data. For example, if values are specified to two decimal places, setting the **Accuracy** to 0.001 is more than adequate. Smaller values will cause the interpolation to run more slowly and will degrade the interpolation result. For example, when recording to two decimals, the range 0.035 to 0.044 will be recorded as 0.04. There is little point in setting the accuracy to plus or minus 0.000001 when intrinsically values are only accurate to plus or minus 0.005.

The Linear Interpolant Function

Generally, estimates produced using the linear interpolant will strongly reflect values at nearby points and the linear interpolant is a useful general-purpose interpolant for sparsely and/or irregularly sampled data. It works well for lithology data, but is not appropriate for values with a distinct finite range of influence.

The linear interpolant function is multi-scale, and, therefore, is a good general purpose model. It works well for lithology data, which often has localised pockets of high-resolution data. It can be used to quickly visualise data trends and whether or not compositing or transforming values will be required. It is not appropriate for values with a distinct finite range of influence as it aggressively extrapolates out from the data. Most ore grade data is not well interpolated using a linear interpolant function.

The linear interpolant function simply assumes that known values closer to the point you wish to estimate have a proportionally greater influence than points that are further away:

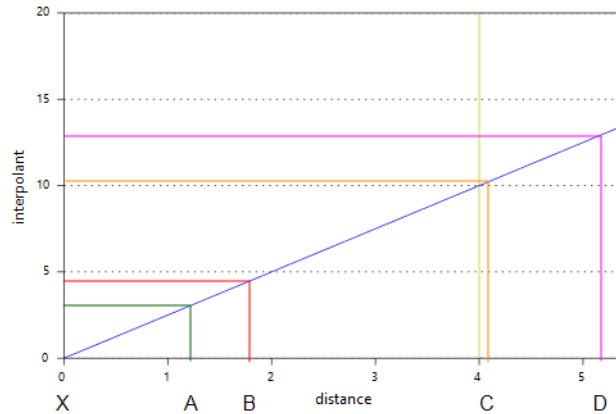

In the above diagram, points A and B will have the most effect on point X as they are closer to X than points C and D. Using the linear interpolant function in Leapfrog Geothermal gives a value of 7.85, which is between the nearby high grade values of A (10) and B (7). Because of their distance from X, the low grade values at C and D have a much weaker effect on the estimate of point X, and they have not dragged the estimate for X lower.

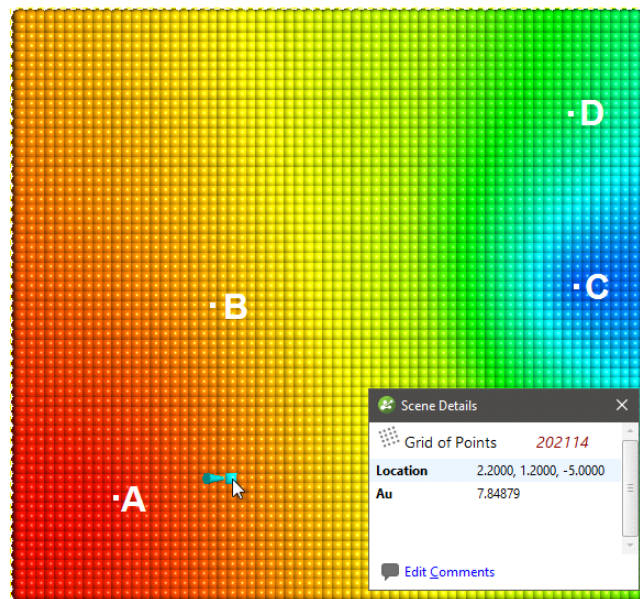

This topic describes the parameters used to define a linear interpolant. These parameters are [Total Sill and Base Range](#), [Nugget](#), [Drift](#) and [Accuracy](#).

To edit the parameters for an interpolant, double-click on the interpolant in the project tree and click on the **Interpolant** tab. The graph on the tab shows how the interpolant function values vary with distance and is updated as you change interpolant parameters:

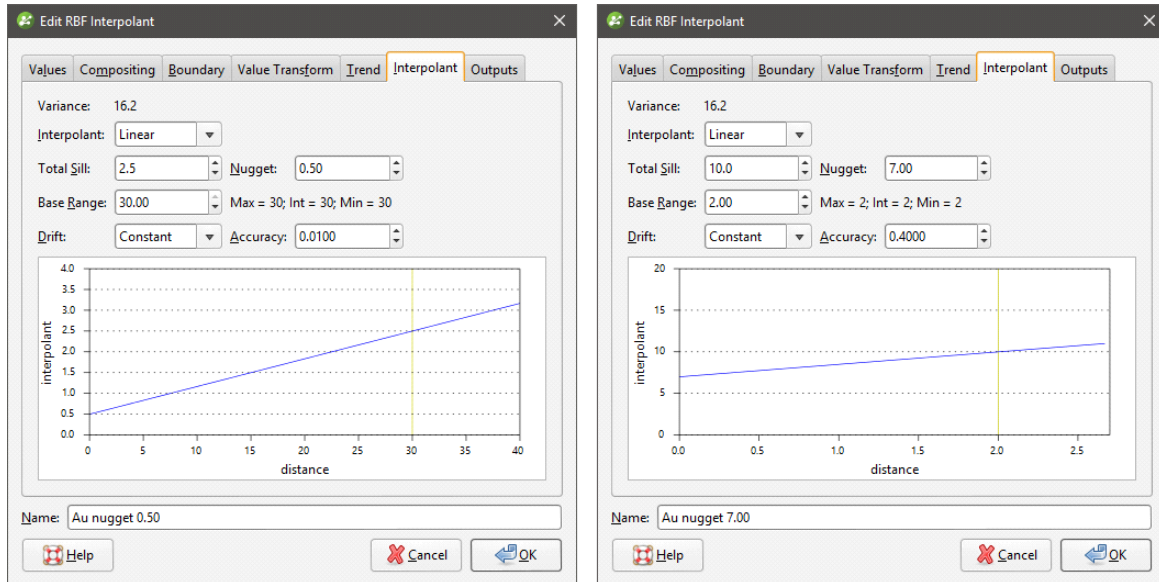

The yellow line indicates the **Base Range**. For this interpolant, the value of the interpolant is offset by the value of **Nugget**.

Total Sill and Base Range

A linear interpolant has no sill or range in the traditional sense. Instead, the **Total Sill** and **Base Range** set the slope of the interpolant. The **Base Range** is the distance at which the interpolant value is the **Total Sill**. The two parameters sill and range are used instead of a single gradient parameter to permit switching between linear and spheroidal interpolant functions without also manipulating these settings.

Nugget

The **Nugget** represents a local anomaly in values, one that is substantially different from what would be predicted at that point based on the surrounding data. Increasing the value of **Nugget** effectively places more emphasis on the average values of surrounding samples and less on the actual data point, and can be used to reduce noise caused by inaccurately measured samples.

Drift

The **Drift** is a model of the value distribution away from data. It determines the behaviour a long way from sampled data.

- **Constant:** The interpolant goes to the approximated declustered mean of the data.
- **Linear:** The interpolant behaves linearly away from data, which may result in negative values.

Here, the two **Drift** options for the interpolant are shown evaluated on grids:

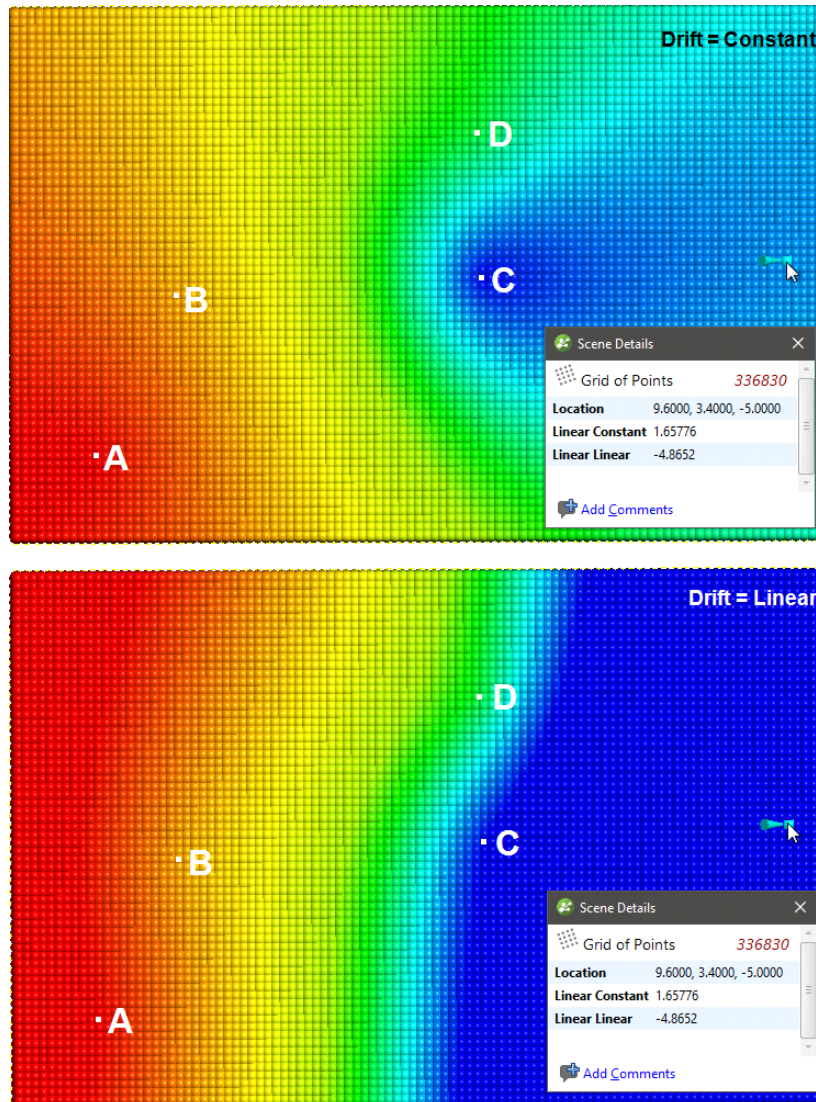

In this example, the boundary is larger than the extent of the data to illustrate the effect of different **Drift** settings.

Accuracy

Leapfrog Geothermal estimates the **Accuracy** from the data values by taking a fraction of the smallest difference between measured data values. Although there is the temptation to set the **Accuracy** as low as possible, there is little point to specifying an **Accuracy** significantly smaller

than the errors in the measured data. For example, if values are specified to two decimal places, setting the **Accuracy** to 0.001 is more than adequate. Smaller values will cause the interpolation to run more slowly and will degrade the interpolation result. For example, when recording to two decimals, the range 0.035 to 0.044 will be recorded as 0.04. There is little point in asking Leapfrog Geothermal to match a value to plus or minus 0.000001 when intrinsically that value is only accurate to plus or minus 0.005.

Central Integration

The Central platform is a model management system. Central's integration with Leapfrog Geothermal lets you work in different project revisions, publish models to the server, view documents and annotations and reply to annotations.

Projects shared within Central can be downloaded and worked on locally in Leapfrog Geothermal. When you have finished working on a project, select the objects you wish to publish to Central and add notes about the revision. New projects can be added to Central by building them from scratch or by uploading an existing project.

This topic describes how to set up and work with Central from within Leapfrog Geothermal. It is divided into:

- [Enabling Central](#)
- [Setting Up the Connection](#)
- [Connecting to Central](#)
- [Viewing a Project's History](#)
- [Sharing Projects](#)
- [Downloading a Local Copy of a Project](#)
- [Publishing to Central](#)
- [New Central Projects](#)
- [Troubleshooting Connectivity Issues](#)

To learn more about Central, see the [Central help](#).

Enabling Central

To enable Central, open the **Settings** window by clicking on the **Leapfrog Geothermal** menu. Select **Central** and tick the box to enable Central. A **Central Projects** tab will appear in the main window.

When you connect to Central, you can download projects and work on them locally. To change the location where projects are saved, click the **Change** button under **Project Files** and navigate to where you want to save projects:

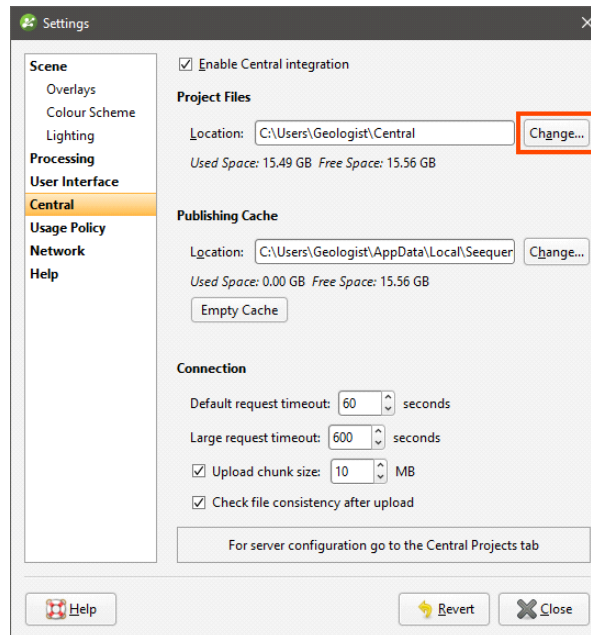

The **Publishing Cache** settings determine where Central data is stored while publishing to Central. If you have a small local drive and use network storage for most of your data, you can change where temporary publishing data is stored. To do this, click on the **Change** button and navigate to the required location.

The **Empty Cache** button clears the publishing cache folder for the connected Central Server. This button is only active when you are connected to a Central server and should only be used if you are having problems publishing to Central.

The **Connection** settings determine the timeout settings for connection to the Central server. The **Large request timeout** is used for publishing, uploading attachments and getting a revision. All other communication with the Central server uses the **Default request timeout**. The **Default request timeout** and **Large request timeout** should only be adjusted upward if you have problems with a poor connection. The default values are 60 seconds and 600 seconds.

The **Upload chunk size** setting is useful if you have a poor connection. It determines the size of the chunks used to upload large files. For example, if the **Upload chunk size** is 10MB and you are uploading a 100MB file, the file will be uploaded in 10 chunks. If your connection is poor and you are experiencing issues, you can decrease the value of the **Upload chunk size**.

There is an option for checking the integrity of a revision after it has been uploaded. If you wish to do this, enable the **Check file consistency after upload** option.

Setting Up the Connection

The first time you connect to Central, you will need to set up your connection. Request an account from your Central administrator, who will provide you with your connection details.

Once you have these details, click on the **Central Projects** tab. Click the **Add** button to add a new server:

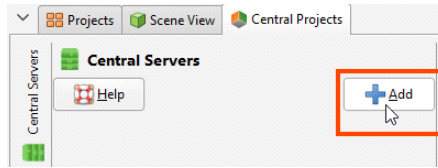

Click **New user** to enter your activation code, then enter the information provided to you by your Central administrator.

The activation code can be used a single time and is for the purposes of setting up your user name and password.

Enter a new password, then accept the terms and conditions and click **Save**.

Connecting to Central

Once Central integration has been enabled, you can see the status of your connection to Central in the lower left-hand corner of the Leapfrog Geothermal main window. Click this button to logout or change Central settings:



If you are logged out, click on the **Central Projects** tab and click the server you wish to connect to:

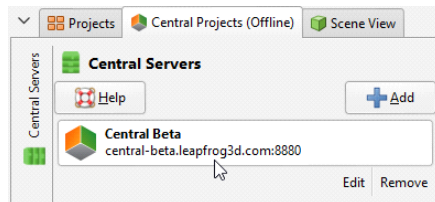

Leapfrog Geothermal version 3.8 is only compatible with Central Server version 2.2. If you get a message saying that the version of Leapfrog Geothermal you are using is not compatible with the Central Server you are trying to connect to, follow the instructions in the message, then try connecting again.

To hide the **Central Servers** panel, click the button:

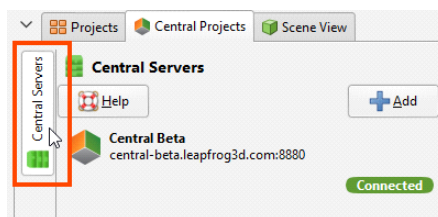

Viewing a Project's History

The **Central Projects** tab shows thumbnails of the projects available in Central. Projects will be organised by location if there are multiple projects at a given location; otherwise projects will simply appear in a list.

A project's location is set in the Central Portal. You cannot change its location from Leapfrog Geothermal.

Click on a project to view its history, which will open in a new tab.

Central projects are organised into revisions and branches:

- Different points in the modelling process are captured as revisions, which are specific points in time.
- A revision can be the basis for a new branch, exploring an alternative hypothesis.

These are displayed visually in a project's history tab, with local copies of projects shown in the panel at the top of the tab:

Graph	ID	Local	Locked	Project	Size	App Name	App Version	Project Stage	Branch	Da
	601	1			331.0MB	Leapfrog Geothermal	3.8.0	Peer review	default	25
	531				169.0MB	Leapfrog Geothermal	3.7.0	Experimental	default	5/
	492				169.0MB	Leapfrog Geothermal	3.6.0	Experimental	default	20
	489				162.0MB	Leapfrog Geothermal	3.6.0	Experimental	default	18
	488				160.0MB	Leapfrog Geothermal	3.6.0	Experimental	default	18

Each local copy is numbered so that it can easily be seen what versions have local copies in the **Local** column. The number in the column corresponds to the project in the **Local copies** panel. You can also:

- Click a thumbnail to open a local copy.
- Click the branch/copy number button (📄) to identify the parent version of the local copy in the project history.
- Click the **Publish** button (🌐) to publish the copy being edited to Central.
- Click the **Delete** button (🗑️) to delete a local copy, if the project is not open.

In the **Project history**, revisions are displayed chronologically, from the most recent down to the oldest. In the **Graph**, offshoots from a revision are branches where an alternative hypothesis has been investigated. Changes made in a branch do not appear in other branches; branches effectively diverge from the base revision. The dots on the graph line up with the revision information.

To view more information about a revision, click on it in the history.

Locking Branches

When working on a branch in Leapfrog Geothermal, the branch can be locked so no other Central users can make changes to it. This is useful for letting other users know that a model is being worked on.

The **Locked** column indicates whether or not the branch is available to be worked on. If a branch is locked, hold the cursor over it to see who locked it and when it will be available once again.

To lock a branch, right-click on it in the project history and select **Lock branch**:

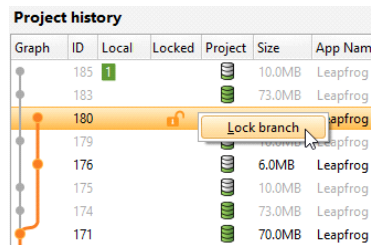

Graph	ID	Local	Locked	Project	Size	App Nam
	185	<input checked="" type="checkbox"/>			10.0MB	Leapfrog
	183				73.0MB	Leapfrog
	180		<input checked="" type="checkbox"/>			Leapfrog
	179					Leapfrog
	176				6.0MB	Leapfrog
	175				10.0MB	Leapfrog
	174				73.0MB	Leapfrog
	171				70.0MB	Leapfrog

In the window that appears, set the **Lock duration** and add any comments. The lock can be set for as little as one day; when the lock expires or when a new publish is completed, the branch will be unlocked for other users. While the branch is locked, other users are still able to download projects, create new branches and publish to branches that are not locked.

If you locked a branch, you can unlock it before the lock expires by right-clicking on it and selecting **Unlock branch**:

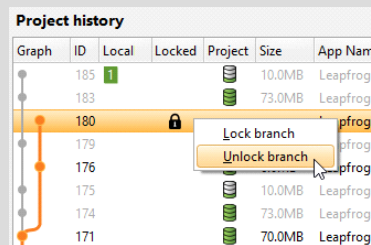

Graph	ID	Local	Locked	Project	Size	App Nam
	185	<input checked="" type="checkbox"/>			10.0MB	Leapfrog
	183				73.0MB	Leapfrog
	180		<input checked="" type="checkbox"/>			Leapfrog
	179					Leapfrog
	176				10.0MB	Leapfrog
	175				73.0MB	Leapfrog
	174				70.0MB	Leapfrog
	171					Leapfrog

You can also ask your Central administrator to unlock a branch.

Project Included

The **Project** column indicates whether or not the Leapfrog Geothermal project was included when the revision was published. If there is no icon displayed, then no project was uploaded when the revision was published. You can view the revision in the Central Browser, but you cannot work on it in Leapfrog Geothermal.

When Leapfrog Geothermal projects are included in a revision, they can be published in a **Complete** state () or in an **Unprocessed** state (). The difference between the two is whether or not stored modelling calculations are included in the published project. Removing stored modelling calculations can make the upload/download size of a revision considerably smaller and is useful when internet connectivity is poor. The tradeoff is that when the project is

downloaded by a Leapfrog Geothermal user, the project will have to be reprocessed before they can use it. This may take some time.

Project Stages

The **Project Stage** is useful for promoting projects through an organisation's procedures. For example, your organisation may have project stages defined that include "Experimental", "Ready for Peer Review" and "Ready for Production". Different stages are displayed in different colours so it is easy to see at a glance what revisions belong to each stage.

Annotations and Attachments

With **Annotations**, Central Browser and Leapfrog Geothermal users can carry out conversations about specific aspects of the model. Annotations include a scene. If you already have the project open in Leapfrog Geothermal, you can load any scene from that project's history by clicking on it. Information about the selected scene will be displayed and you will be prompted to load all the objects or only the unchanged objects:

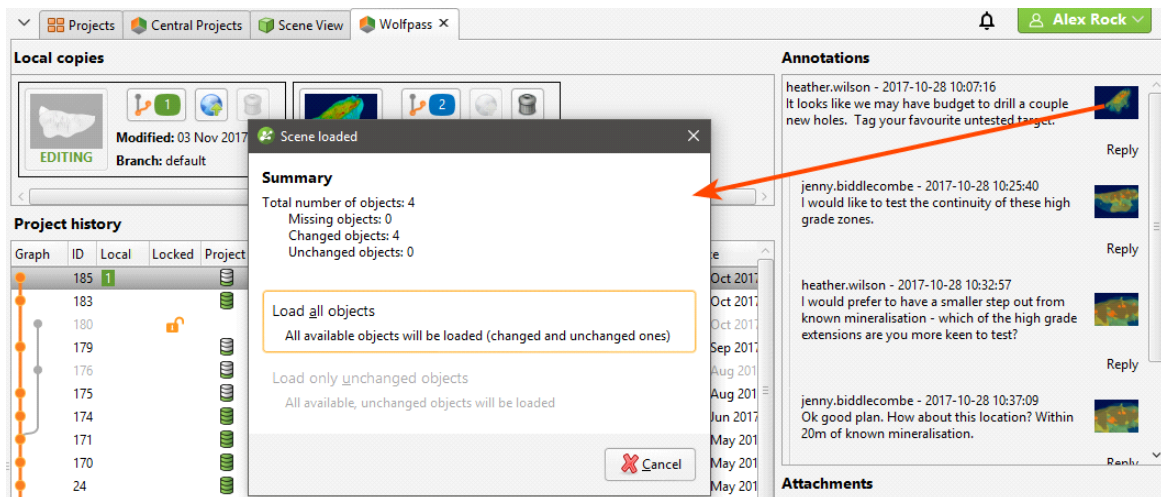

If the selected scene has a geotag, it will be added to the shape list and displayed in the scene. Central Browser users can also attach files, which can be downloaded in Leapfrog Geothermal.

Sharing Projects

If you are a project's owner, you can share it with other Central users by clicking the **Share Project** button in the project's history tab:

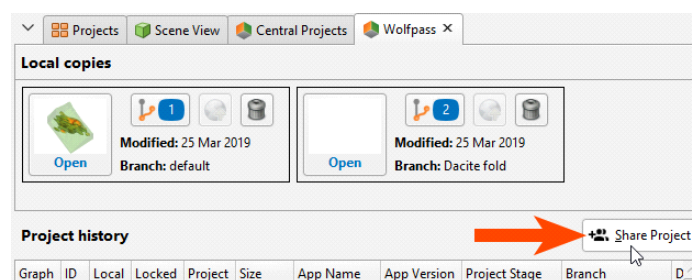

Clicking **Share Project** opens the Central Portal, displaying the **Permissions** page for the project:

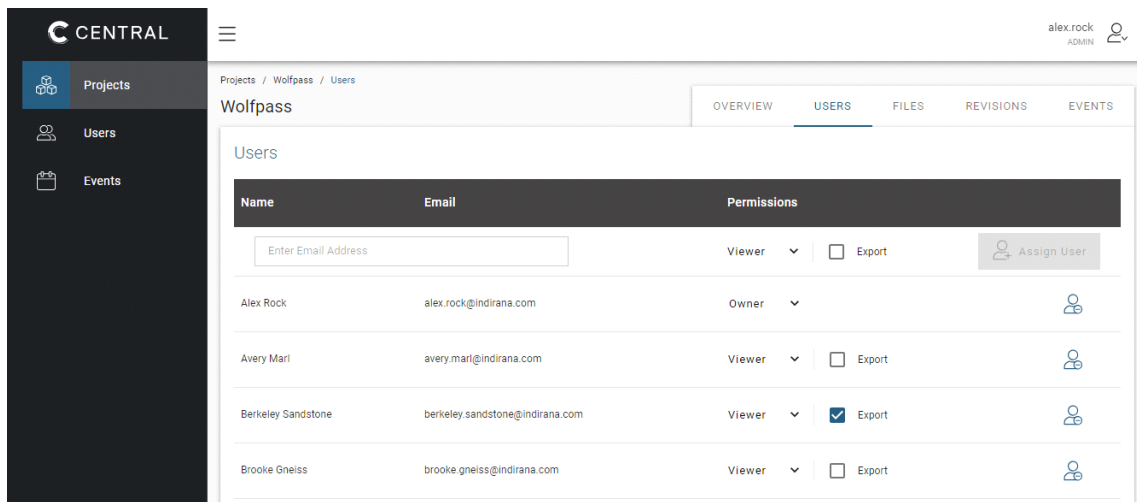

You may need to sign in to the Portal.

Click in the **Add/Remove Users** list to select from the other users in the system, then assign their permissions.

There are four levels of project permissions in Central: **Owner**, **Editor**, **Viewer+Export** and **Viewer**.

An **Owner** can:

- Assign other users as the owner. A project can have more than one owner.
- Configure and add an integration to a project they own.

A user who uploads a new project to Central is automatically assigned as the project owner.

Editor access allows a user to work in a project in Leapfrog.

Viewer+Export access allows a user to open a project in the Central Browser and export data from the project.

Viewer access allows a user to open a project in the Central Browser and make annotations. They cannot export data from the project.

Downloading a Local Copy of a Project

Select a revision and then click **Download** to download a local copy of the project. The project will be downloaded to the location on your local drive specified in the **Settings > Central** window. A new revision of the project will be created in the history, as an unpublished project.

Click the **Open** button in the **Local copies** panel to open the project:

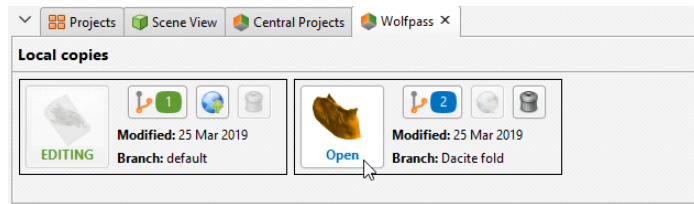

Work in the project as you would any other Leapfrog Geothermal project.

Publishing to Central

When you are ready to submit your project to Central, you can start the publishing process by clicking on the Central button in the lower left-hand corner of the screen and selecting **Publish**:

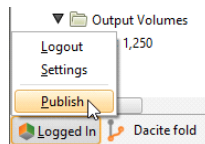

You can also select the **Publish** button (🌐) in the **Local copies** panel:

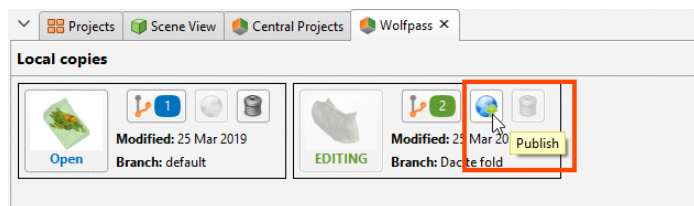

The steps in publishing a project to Central are:

- [Unfinished Publish Events](#)
- [Selecting Objects](#)
- [Setting the Project Workflow Stage](#)
- [Including the Project](#)
- [Adding Revision Information](#)
- [Preparing the Package](#)
- [Uploading the Package](#)

Unfinished Publish Events

When you click **Publish**, you may receive a message saying there is an unfinished publish event:

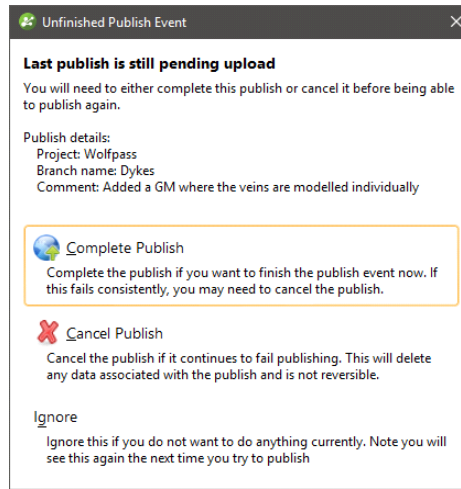

This occurs when a previous publish event was interrupted. Choose from the options presented. If the publish event was abandoned, it can be removed via the Central Portal.

Selecting Objects

Select the objects you wish to publish from those available in the project:

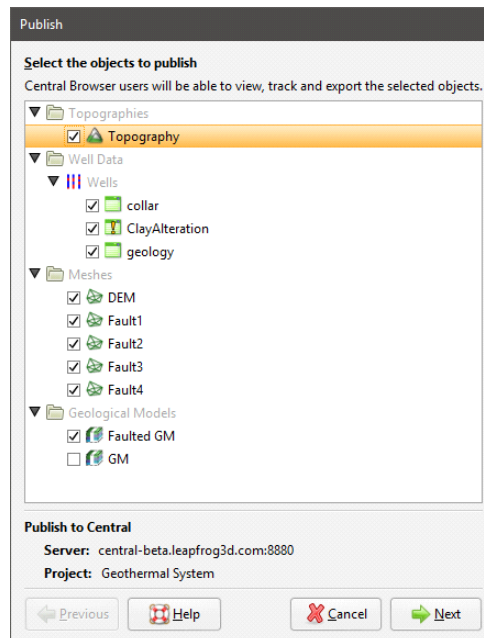

Although sub-blocked models can be published to Central, the dip will not be included.

Click **Next** to choose options for how the project will be uploaded.

Setting the Project Workflow Stage

Project stages are useful for advancing projects through an organisation's processes. If the project is ready to be moved on to a different stage, select a different **Project Workflow Stage** from the list.

Project stages can later be changed in the Central Browser.

Including the Project

Select whether or not to include the Leapfrog Geothermal project. There are three options:

- **No.** The Leapfrog Geothermal project will not be published. Other Central users will not be able to download the project and work on it in Leapfrog Geothermal. They will, however, be able to review the published objects and their history in the Central Browser.
- **Complete.** This option publishes the complete Leapfrog Geothermal project, including stored modelling calculations. Other Central users will be able to download the project and work on it in Leapfrog Geothermal without reprocessing the project.
- **Unprocessed.** An unprocessed project has a smaller upload/download size because stored modelling calculations are removed. When an unprocessed project is downloaded again, all of the modelling calculations will need to be reprocessed from the underlying data. Other Central users will be able to download the project and work on it in Leapfrog Geothermal. Depending on the size of the project, reprocessing may take some time.

Click **Next**.

Adding Revision Information

Enter information about the new revision. If you want to create a new branch, click the **New Branch** button and enter a name for the branch.

Once you branch from a timeline, you cannot merge back into it. There's no reason, however, that you can't keep working in a branch and start considering that the main branch, if that's the conclusion you and your team reach.

Preparing the Package

Click **Next** to begin the processes of packaging the project for publication.

Uploading the Package

Once the project has been packaged, there are two options for starting the upload:

- If you want the upload to begin automatically once the package has been prepared, tick the **Auto upload** box.

- If you want the option to cancel the upload once it has been packaged, leave the **Auto upload** box unticked. Once the project has been packaged, click **Publish** to upload the project to Central.

If for some reason you need to stop the upload, click on the Central button in the lower left-hand corner of the screen and select **Stop Upload**:

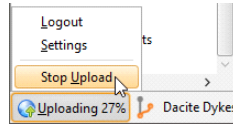

You can resume the upload by clicking **Publish** in the project history. You will be prompted to resume the unfinished publish event, as described in [Unfinished Publish Events](#) above.

If the upload is interrupted because the connection to the server is lost, you will be prompted to finish the publish event the next time you log in to Central.

If you exit Leapfrog Geothermal while a publish event is in progress, you will be warned that a publish event is in progress. You can:

- Cancel exiting Leapfrog Geothermal, in which case the publish event will continue.
- Confirm that you wish to exit Leapfrog Geothermal. The next time you connect to this Central server or publish from this project or from another project on the same server, you will be prompted to resume the interrupted publish event. You can complete the interrupted publish event, if you wish, or ignore it.

New Central Projects

There are two options for putting a project into Central:

- Create a new Central project.
- Put an existing project into Central.

Creating a New Central Project

Use this option to create a new Leapfrog Geothermal project and put it into Central. In the **Central Projects** tab, click **Create blank project**. Enter a name for the project and click **OK**. A new Leapfrog Geothermal project will be created and saved in the location on your local drive specified in the **Settings > Central** window.

Work in the project as you would any other Leapfrog Geothermal project. When you are ready to publish the project to Central, click on the Central button in the lower left-hand corner of the screen and select **Publish**:

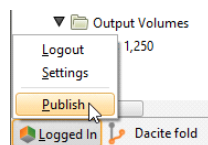

Adding a Project to Central

Use this option to add an existing project to Central.

Open the project you wish to import, then in the **Central Projects** tab, click **Import open project**. Enter a new name for the project, if you wish, then click **OK**. The project will be opened and copied to the location on your local drive specified in the **Settings > Central** window.

Work in the project as you would any other Leapfrog Geothermal project. When you are ready to publish the project to Central, click on the Central button in the lower left-hand corner of the screen and select **Publish**.

Troubleshooting Connectivity Issues

Leapfrog Start checks to see if your network will support the connection of Leapfrog web-based services to your desktop applications. If you are having trouble with your connection to Central, see [Checking Connectivity with Leapfrog Start](#).

Settings

Open the **Settings** window by clicking on the **Leapfrog Geothermal** menu and selecting **Settings**:

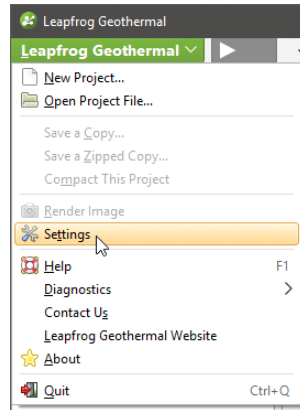

The settings available in this window are described below:

- [Display and Navigation Settings](#)
- [Overlay Settings](#)
- [Colour Scheme](#)
- [Lighting Settings](#)
- [Processing Settings](#)
- [User Interface Settings](#)
- [Central Settings](#)
- [Network Settings](#)
- [Help Settings](#)

To close the **Settings** window and leave settings unchanged, click the **Revert** button, then click **Close**.

Display and Navigation Settings

In the **Settings** window, click on **Scene** to change scene display and navigation settings.

3D Acceleration Mode

Leapfrog Geothermal can run in one of three acceleration modes. Click the **Acceleration mode** button in the **Settings > Scene** window to use a different mode. The modes available are:

- **Software Rendering** uses software only, for maximum compatibility with any hardware. This option can be very slow displaying all but the simplest scenes, and is provided as a fall-back if display issues cannot be resolved with either of the other two options.

- **Partial Acceleration** uses hardware acceleration that has been provided on graphics cards for many generations. In this mode, Leapfrog Geothermal renders scenes using “fixed function pipeline” hardware acceleration features that have been superseded in modern graphics cards by programmable shaders, but this legacy capability is widely supported and offers performance advantages over software rendering. Using **Partial Acceleration** can sometimes fix anomalies or problems encountered in **Full Acceleration** mode that may be due to bugs in old drivers, and it should work with even old or lower-featured hardware.
- **Full Acceleration** is the best option, assuming you have good hardware and up-to-date drivers. Because it makes use of programmable shaders provided by modern graphics cards, it is the fastest of the three modes and uses your available graphics memory more efficiently. It is the mode you should use, if your system supports it.

First, try using **Full Acceleration** and see how it renders scenes. If you seem to be having issues with how data is displayed in the scene, see [Running the Graphics Test](#) for information on testing your computer’s graphics capabilities. Note that especially when graphics cards are new on the market, there may be a number of driver versions released to address anomalies, so the use of a recent driver version is important. If using a laptop with dual graphics cards, use it with the power supply connected, and select the **Performance Graphics** option over the **Power Saving** option.

If that doesn’t resolve the graphics problems, then try **Partial Acceleration** mode. If possible, avoid using **Software Rendering** as it can be very slow.

If your current hardware is unable to support **Full Acceleration** mode, it may be worth considering upgrading your graphics card. Medium- to high-end home PC and gaming graphics cards are sufficient. High-end workstation grade cards also work very well, but you will also be paying for further capabilities that are not utilised by Leapfrog Geothermal.

The acceleration mode can also be changed by clicking the button at the bottom of the Leapfrog Geothermal main window:

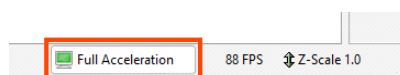

Font Size

This setting is the size of text used to display information on the grid and axes.

Z Axis Scale

The **Z-axis scale** setting lets you set a value greater than 1.0 for the z-axis relative to the x- and y-axes. This is useful when the area under study is very planar and extends over a wide area. In such cases, scaling the z-axis can accentuate the distribution of data along the z-axis. If you have a project open when you change this setting, the change will be reflected in the scene so you can experiment with different values before choosing the one that best accentuates the distribution of data.

The z-axis setting can also be changed by clicking the **Z-Scale** button at the bottom of the Leapfrog Geothermal main window:

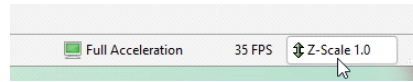

The **Scale Z Axis** window will appear:

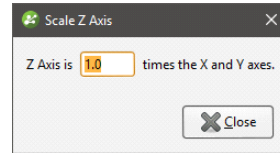

Note that each project saves the z-axis scaling setting when the project is closed. In addition, when saving scenes (see [Saved Scenes](#)), the z-axis scale is saved as part of the scene.

Rotation Settings

The **Geographic rotation** and **Free rotation** settings determine whether or not the model displayed in the scene window can be “rolled”. With the **Geographic rotation** option, the azimuth and elevation can be varied, but the z-axis is constrained to be vertical. With the **Free rotation** option, however, the rotation of the model is not fixed to any axis and the model can be freely rolled around any axis. Select the option you prefer. When Leapfrog Geothermal is installed, **Geographic rotation** is set as the default option as it is the most commonly used.

The **Rotate with left button** and **Rotate with right button** settings determine how the mouse is used to rotate the scene:

- When **Rotate with left button** is selected, you can rotate the scene by holding down the left mouse button and dragging in the scene. Clicking and holding the right mouse button zooms in and out of the scene.
- When **Rotate with right button** is selected, holding down the right mouse button and dragging rotates the scene. However, zooming and rotating functions are not swapped. Instead, the left mouse button can only be used for clicking on different objects in the scene. Select this option if you tend to accidentally move the scene when you intend to click.

Camera Settings

The **Orthographic projection** and **Perspective projection** settings determine the view of the model in the scene window.

If **Perspective projection** is selected, you can change the **Perspective angle** using the slider. This is similar to adjusting the zoom setting on a camera. Higher angles make nearby objects larger and more distant objects smaller. Lower angles will compress the scene. Experiment with the settings to see the effect on objects in the scene.

Select the option you prefer.

Overlay Settings

In the **Settings** window, click on **Scene > Overlays** to change what objects are included in the scene.

Changes you make to these settings are automatically updated in the scene so you can easily experiment to see what overlays you prefer.

Select **Revert** to return to the settings in place when the **Settings** window was first opened.

Screen Grid Settings

The **Show screen grid** setting determines whether or not the screen grid is displayed. Select the option you prefer. The **Loose Spacing**, **Normal Spacing** and **Fine Spacing** options determine the spacing of the grid.

Axis Lines Settings

The **Axis Lines** settings determine how X-Y-Z coordinates are displayed in the scene. When axis lines are enabled, the axes indicate the extent of data currently displayed in the scene.

- Enable **Show axis lines** to display the east (red), north (green) and elevation (blue) axis lines.
- Enable **Put numbers on axes** to display scale ticks along the grid. These are automatically adjusted to fit the extent of the data and the current zoom setting.
- Enable **Show whole box** to display the axis lines as a box that encloses the current data set.

Other Overlay Settings

The scale bar, compass ball and viewing angle text are the navigation aids in the lower right-hand corner of the scene window.

When the slicer is in the scene and the slice is aligned with the x-, y- or z-axis, text describing the slicer position can be displayed in the lower left-hand corner of the scene. To do this, enabled the **Slicer position text** option.

When drawing polylines, tooltips are displayed. If you do not wish to view these tooltips, untick the box for **Polyline help text**.

Colour Scheme

In the **Settings** window, click on **Scene > Colour Scheme** to change the colour scheme used in the scene. The options that can be changed include:

- The background colour used in the **Scene View** tab
- The colour and width used to display well traces

- The colour and width of mesh edges, together with the width of the line used when a mesh is sliced and the highlight colour used when mesh parts are selected in the scene
- The colours used for displaying the x, y and z axes
- Grid line width, style and colour
- Axes box line width, style and colour
- Slicer edge width, style and colour

Leapfrog Geothermal is installed with three colour schemes: **Default**, **Black Background** and **White Background**. The scheme selected in the **Schemes** list will be used for all new Leapfrog Geothermal projects and for existing projects when they are next opened.

- Experiment with the settings to see how they affect the scene window. The scene will be updated as you make changes.
- Select **Revert** to return to the settings in place when the **Settings** window was first opened.
- To create a new scheme, click on an existing scheme. This is the scheme that will be used as a basis for defining the new scheme. Next, click the **New Scheme** button and change its settings.
- Click **Factory Reset** to revert to the colour schemes defined when Leapfrog Geothermal was first installed.

Clicking on **Factory Reset** to revert to the original colour schemes deletes any custom colour schemes.

If you are working on a slow connection, you can download a copy of the help that can be saved to your hard drive. To do this:

- [Click here to download a copy of the help.](#)
- Once you have downloaded a copy of the help and installed it, select **Settings** from the **Leapfrog Geothermal** menu.
- Click on the **Help** tab and then select **Local folder**.

Leapfrog Geothermal help is updated at each release. If you are using a downloaded copy, you will need to download a new copy each time you update Leapfrog Geothermal.

Lighting Settings

In the **Settings** window, click on **Scene > Lighting** to change how visual effects are displayed in the scene window. You may be able to use these settings to emphasise significance in the data displayed in the scene.

- The **Ambient level** setting determines the overall brightness of the scene.

- The **Specular brightness** and **Specular shininess** settings determine how light appears to fall on the surfaces in the scene. The **Specular brightness** setting has a stronger effect when **Specular shininess** is soft.

You can have up to four light sources defined for a project. By default, two light sources are defined.

Changes made to these settings are automatically applied to the scene.

- Click **Revert** to return to the settings in place when the **Settings** window was first opened.
- Click **Factory Reset** to revert to the lighting sources and settings defined when Leapfrog Geothermal was first installed.

Processing Settings

In the **Settings** window, click on **Processing** to change how background processing is used to run changes to data and models. The **Automatic** option creates one process for each physical CPU core on your computer or one for every 2.5 GB of RAM, whichever is smaller. However, there is an upper limit of 8 processes.

You can manually set the number of **Background processes** you would like to commit resources to. For example, you might want to use all but one process for Leapfrog Geothermal and reserve one for other application use.

Select **Revert** to return to the settings in place when the **Settings** window was first opened.

User Interface Settings

In the **Settings** window, click on **User Interface** to change project tree and scene toolbar options and to enable uploading to View.

Show Tree Lines

Ticking the box for **Show Tree Lines** displays objects in the project tree with lines:

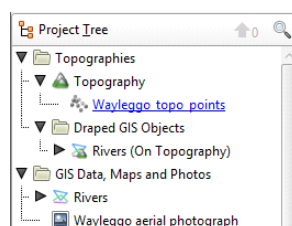

Enable this option if you find it useful for displaying relationships between objects in the project tree.

Show Save Scene Button

Ticking the **Show Save Scene** box adds an extra button to the scene toolbar:

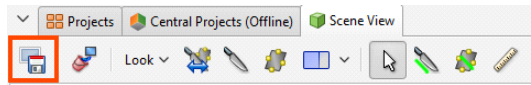

Click this button to save the current scene.

You can also change the scene toolbar by right-clicking on it and selecting **Customise**.

Upload to View

Ticking the box for **Show View upload** displays the **View** button (📁) in the **Scene View** toolbar. See [Uploading to View](#) for more information.

Tab Position

Some Leapfrog Geothermal windows open in separate tabs that can be used either docked or detached. The position in which tabs open is determined by the **New tab position** setting:

- Open all tabs in the main window.
- Open all tabs in separate windows.
- Tabs can open where the last tab was moved to. This setting can be used for creating a window in which all tables and dockable windows open, with the scene window, project tree and shape list in another window.

Central Settings

To enable Central, open the **Settings** window by clicking on the **Leapfrog Geothermal** menu. Select **Central** and tick the box to enable Central. A **Central Projects** tab will appear in the main window.

When you connect to Central, you can download projects and work on them locally. To change the location where projects are saved, click the **Change** button under **Project Files** and navigate to where you want to save projects:

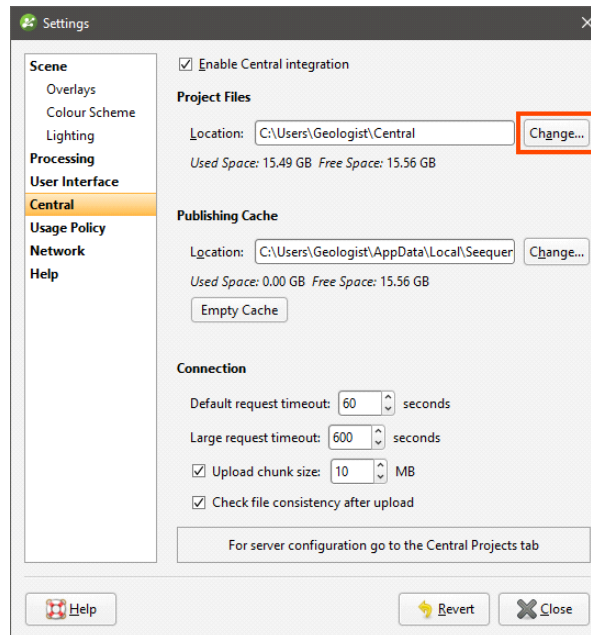

The **Publishing Cache** settings determine where Central data is stored while publishing to Central. If you have a small local drive and use network storage for most of your data, you can change where temporary publishing data is stored. To do this, click on the **Change** button and navigate to the required location.

The **Empty Cache** button clears the publishing cache folder for the connected Central Server. This button is only active when you are connected to a Central server and should only be used if you are having problems publishing to Central.

The **Connection** settings determine the timeout settings for connection to the Central server. The **Large request timeout** is used for publishing, uploading attachments and getting a revision. All other communication with the Central server uses the **Default request timeout**. The **Default request timeout** and **Large request timeout** should only be adjusted upward if you have problems with a poor connection. The default values are 60 seconds and 600 seconds.

The **Upload chunk size** setting is useful if you have a poor connection. It determines the size of the chunks used to upload large files. For example, if the **Upload chunk size** is 10MB and you are uploading a 100MB file, the file will be uploaded in 10 chunks. If your connection is poor and you are experiencing issues, you can decrease the value of the **Upload chunk size**.

There is an option for checking the integrity of a revision after it has been uploaded. If you wish to do this, enable the **Check file consistency after upload** option.

See [Central Integration](#) for more information on using Central.

Network Settings

If your organisation uses a proxy server to connect to the internet, you can set this up in the **Settings > Network** window.

If you choose the **Autodetect proxy server** option, Leapfrog Geothermal will detect the authentication type, server address and port; there are no further settings for you to change.

If **Autodetect proxy server** does not work or if you need to switch between proxy servers in different network environments, choose the **Manually configure proxy server** option and enter the information provided by your IT department. The advanced settings are optional and you should only change them from the default values if you have been instructed to do so by your IT department.

You can manually configure more than one proxy server. Click the **New** button to add a new profile and enter the required settings. When you want to swap from one proxy server to another, simply select a **Profile** from those already defined.

If you have multiple Seequent products running on your computer, you only need to configure network proxy settings once. Once you have, for example, configured the proxy for Leapfrog Geothermal, the same settings will be used for the Central Browser.

Help Settings

If you are working on a slow connection, you can download a copy of the help that can be saved to your hard drive. To do this:

- [Click here to download a copy of the help.](#)
- Once you have downloaded a copy of the help and installed it, select **Settings** from the **Leapfrog Geothermal** menu.
- Click on the **Help** tab and then select **Local folder**.

Leapfrog Geothermal help is updated at each release. If you are using a downloaded copy, you will need to download a new copy each time you update Leapfrog Geothermal.

Reporting a Problem

If Leapfrog Geothermal encounters an error, the **Leapfrog Geothermal Problem** window will be displayed. Enter as much information as you can about the problem, then click **Send**.

Getting Support

Technical support is available by visiting <http://www.leapfrog3d.com/contact/support>.

Checking Connectivity with Leapfrog Start

Leapfrog Start checks to see if your network will support the connection of Leapfrog web-based services to your desktop applications.

To run Leapfrog Start, either click the **Test Web Services** button in the **Settings > Network** window or click on the **Leapfrog Geothermal** menu and select **Diagnostics > Test Web Services**:

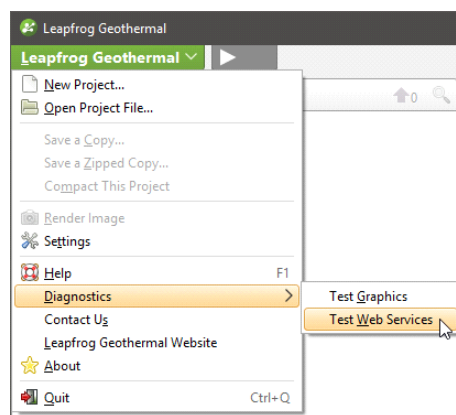

Supplying Your Licence Details

When contacting technical support, please include your licence number and a full description of the problem or query, including any information provided in system error messages.

You can access your licence information by selecting **About** from the **Leapfrog Geothermal** menu:

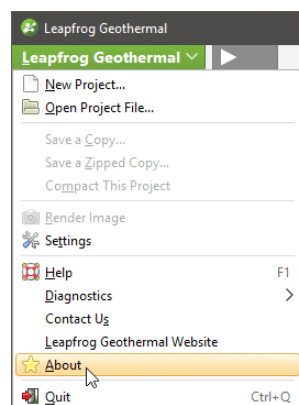

You may also be asked to provide a copy of the log files. To find out where these are stored, select **About** from the **Leapfrog Geothermal** menu, then click on the **System Info.** tab. Click on the link to open the folder that contains the log files:

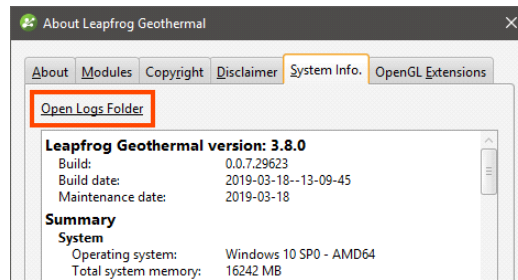

Data Types

Leapfrog Geothermal has tools for importing, creating and working with many different types of data, including:

- [GIS Data, Maps and Images](#)
- [Well Data](#)
- [Points Data](#)
- [Geophysical Data](#)
- [Structural Data](#)
- [Meshes](#)
- [Polylines](#)

Leapfrog Geothermal is unit-less and adopts the units used in the data you import. For example, if your imported data is in metres, the units displayed will be metres, and figures such as resolution, measured distances and slicer thickness will be in metres. It is important, therefore, to be consistent in the units used in the data you import. If you are importing data that uses different coordinate systems, you will need to pre-process the data so that it is using the same coordinate system.

The rest of this topic describes how to open, edit and correct errors in data tables in Leapfrog Geothermal. It is divided into:

- [Working with Data Tables](#)
- [Identifying Errors in Data Tables](#)
- [Exporting Data Errors](#)
- [Correcting Data Errors in Leapfrog Geothermal](#)
- [Common Errors and How to Fix Them](#)
- [Handling Special Values](#)

Working with Data Tables

To view the contents of a data table, double-click on it in the project tree. To view the contents of the attribute table for a GIS object, right-click on the object and select **Attribute Table**. The **Table** window will appear:

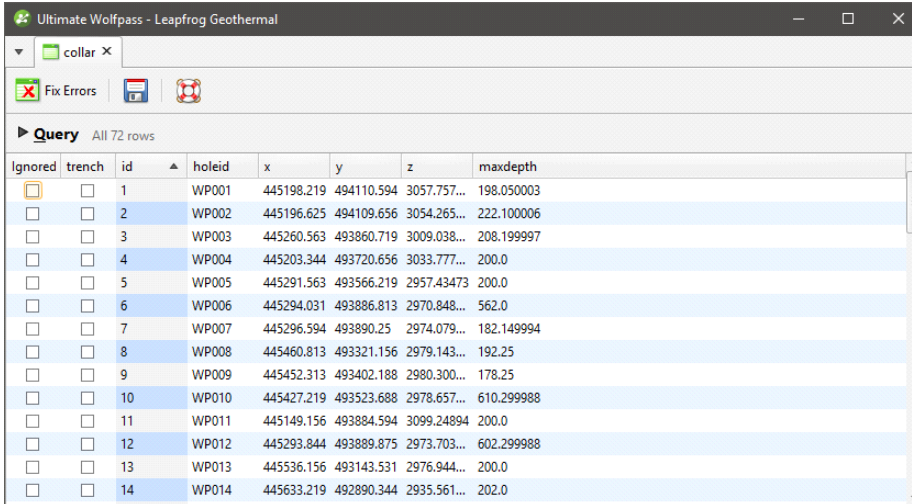

Ignored	trench	id	holeid	x	y	z	maxdepth
<input type="checkbox"/>	<input type="checkbox"/>	1	WP001	445198.219	494110.594	3057.757...	198.050003
<input type="checkbox"/>	<input type="checkbox"/>	2	WP002	445196.625	494109.656	3054.265...	222.100006
<input type="checkbox"/>	<input type="checkbox"/>	3	WP003	445260.563	493860.719	3009.038...	208.199997
<input type="checkbox"/>	<input type="checkbox"/>	4	WP004	445203.344	493720.656	3033.777...	200.0
<input type="checkbox"/>	<input type="checkbox"/>	5	WP005	445291.563	493566.219	2957.43473	200.0
<input type="checkbox"/>	<input type="checkbox"/>	6	WP006	445294.031	493886.813	2970.848...	562.0
<input type="checkbox"/>	<input type="checkbox"/>	7	WP007	445296.594	493890.25	2974.079...	182.149994
<input type="checkbox"/>	<input type="checkbox"/>	8	WP008	445460.813	493321.156	2979.143...	192.25
<input type="checkbox"/>	<input type="checkbox"/>	9	WP009	445452.313	493402.188	2980.300...	178.25
<input type="checkbox"/>	<input type="checkbox"/>	10	WP010	445427.219	493523.688	2978.657...	610.299988
<input type="checkbox"/>	<input type="checkbox"/>	11	WP011	445149.156	493884.594	3099.24894	200.0
<input type="checkbox"/>	<input type="checkbox"/>	12	WP012	445293.844	493889.875	2973.703...	602.299988
<input type="checkbox"/>	<input type="checkbox"/>	13	WP013	445536.156	493143.531	2976.944...	200.0
<input type="checkbox"/>	<input type="checkbox"/>	14	WP014	445633.219	492890.344	2935.561...	202.0

If the **Ignored** column is ticked, then Leapfrog Geothermal completely ignores that row, as though it has been deleted. This is useful for suppressing erroneous data from being processed.

If a row in a collar table is ignored, then all other data associated with that hole (e.g. surveys and interval measurements in other tables) are also ignored.

Collar tables have a **trench** column that indicates whether or not the well is from a trench. When the **trench** column is ticked for a well, the trench will be desurveyed in a different manner from other wells. See [The Raw Tangent Algorithm](#) for more information.

Cells in a table are editable, apart from the **id** column, which Leapfrog Geothermal uses as unique identifier. Double-click in a cell to edit it. If the cell you wish to edit is already selected, press the space bar to start editing.

When you edit a cell, the change will be indicated in bold text:

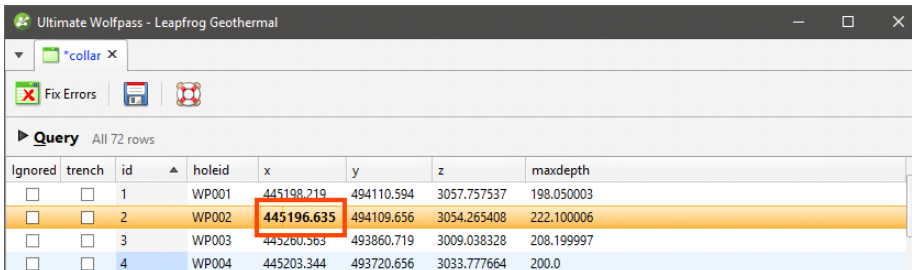

Ignored	trench	id	holeid	x	y	z	maxdepth
<input type="checkbox"/>	<input type="checkbox"/>	1	WP001	445198.219	494110.594	3057.757537	198.050003
<input type="checkbox"/>	<input type="checkbox"/>	2	WP002	445196.635	494109.656	3054.265408	222.100006
<input type="checkbox"/>	<input type="checkbox"/>	3	WP003	445260.563	493860.719	3009.038328	208.199997
<input type="checkbox"/>	<input type="checkbox"/>	4	WP004	445203.344	493720.656	3033.777664	200.0

When you save the table, the edited text will no longer be displayed in bold.

The controls in the table toolbar provide quick access to table operations:

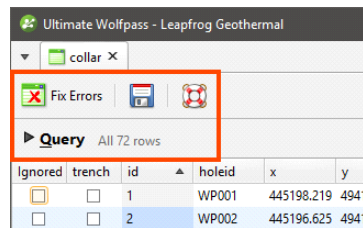

Click on **Fix Errors** to begin correcting errors in the table. See [Correcting Data Errors in Leapfrog Geothermal](#) and [Handling Special Values](#) below for more information.

Click on **Query** to open up the query editor:

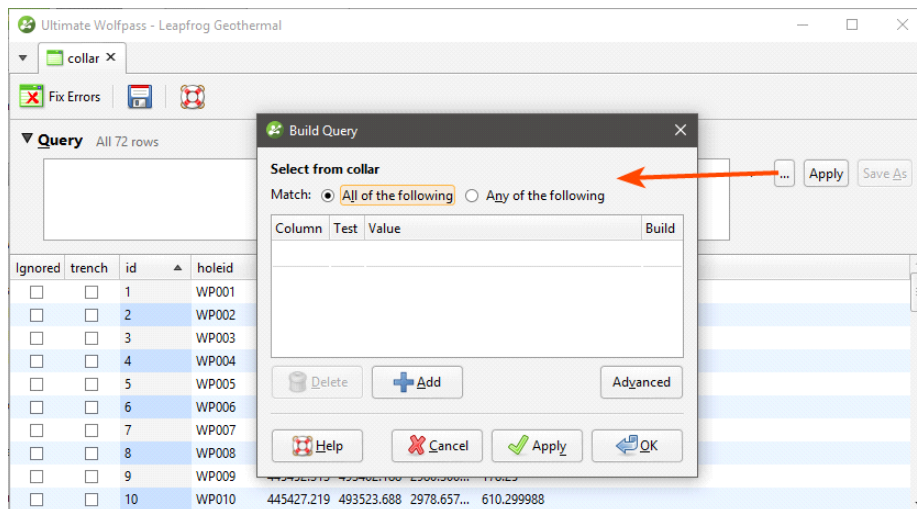

See the [Query Filters](#) topic for more information on how to build and use queries.

With well data, survey tables have **Compatibility** options for changing the desurveying method for the survey table as a whole. See [Well Desurveying Options](#) for more information.

Identifying Errors in Data Tables

Leapfrog Geothermal automatically identifies and flags common data errors when data tables are imported. In the project tree, there are three ways Leapfrog Geothermal marks tables that contain conflicts or errors:

- Tables marked with a red X (✘) contain errors that mean data cannot be used for processing. These errors can be corrected by opening the **Errors** window, which is described in [Correcting Data Errors in Leapfrog Geothermal](#) below.
- Numeric data columns marked with a red X (✘) contain non-numeric values, which means that the rules that are used to handle non-numeric and negative values need to be reviewed. If a table has data that contain non-numeric and negative values, the affected rows cannot be used for further processing until the rules are verified, which is described in [Handling Special Values](#) below.

- Tables marked with a yellow exclamation mark (🚩) contain warnings. Affected rows can be used for further processing, but the information in the warning can indicate that the data requires further attention. For example, if a warning indicates there is data missing for a well defined in the collar table, it may be that a well has been duplicated or that not all required data files have been loaded. Warnings are listed along with table errors in the **Errors** window.

Until errors are corrected, the rows that contain those errors are excluded for all processing that uses the table, including viewing in the scene. For example, if the ID for a collar position contains an invalid coordinate, that collar will not be displayed in the scene as its location is not known. Likewise, any processing will ignore data associated with this well.

It is worth correcting errors as soon as possible, as correcting them later can result in significant recomputation time.

When a table contains errors and warnings, only the errors will be apparent in the project tree view. However, all errors and warnings relevant to a particular table will be displayed in the **Database Errors** window.

There are two approaches to correcting errors in data:

- Correct the data in the primary source. Export the errors as described in [Exporting Data Errors](#) below. Then, when the errors have been corrected, reload the well data as described in [Reloading Well Data](#).
- Correct the data in Leapfrog Geothermal. If you need a record of corrected errors, first export the errors as described in [Exporting Data Errors](#) below. Then correct errors as described in [Correcting Data Errors in Leapfrog Geothermal](#).

Exporting Data Errors

If you need a record of corrected errors, first export the errors. This must be done first, as once errors have been corrected in Leapfrog Geothermal, they cannot be exported, as they no longer exist.

For individual well tables, points tables and structural data tables, export the errors by right-clicking on the table and selecting **Export Errors**. Choose a location where the file will be saved and click **Save**.

To export all errors in the well data set, right-click on the **Wells** object and select **Export Errors**. The **Export Well Errors** window will appear:

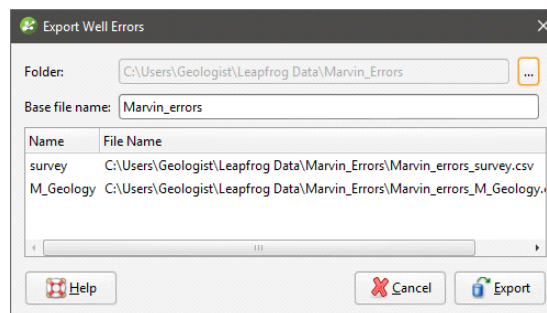

The list shows the files that will be created, one for each table that contains errors. Choose a folder where the files will be saved, then enter a **Base file name**, which will be added to the front of each file name.

Click **Export** to export the error files.

Correcting Data Errors in Leapfrog Geothermal

If you require a record of the errors in well data, export the errors as described in [Exporting Data Errors](#) above before starting to correct the errors in Leapfrog Geothermal.

To correct errors in a data table, right-click on the table and select **Fix Errors**. The **Well Errors** window will appear. Leapfrog Geothermal identifies a range of common errors, and all errors identified in a table are grouped by type. Click on an error type to expand it and see the source of a specific error:

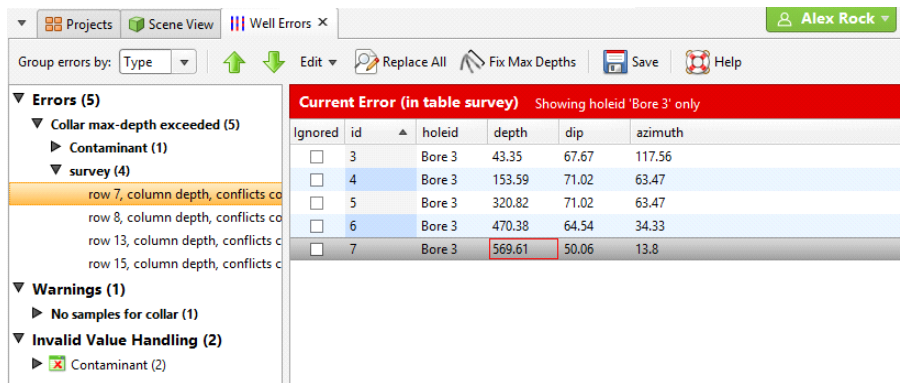

You can change the size of the **Well Errors** window and the columns in the table to view more information easily. When you have finished fixing errors, click the **Save** button (📁). Leapfrog Geothermal will then update the database.

Errors are automatically grouped by **Type**, but if there are many errors, you may find it useful to view them grouped by **Table** or **HoleID**:

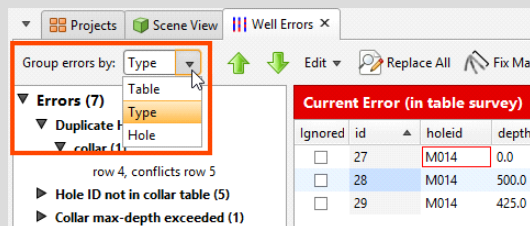

When a row that contains an error is selected, a red box indicates the source of the error. When two rows of data conflict, both rows will be displayed, which may be useful in determining how to fix the error:

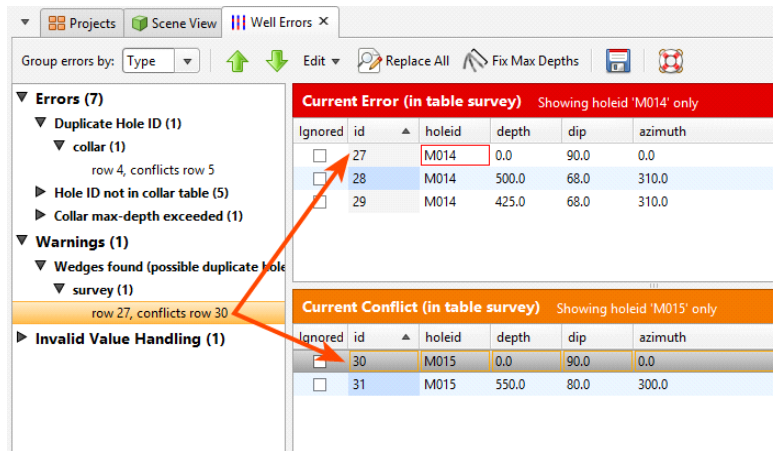

Some typical errors and how to correct them are described in [Common Errors and How to Fix Them](#) below.

Replacing Values in a Column

The **Replace All** button in the toolbar may be useful in correcting any errors without closing the **Well Errors** window. With the **Replace All** button, you can replace an incorrect value that occurs multiple times in a column. To do this, click the **Replace All** button (🔍). Select the **Column** to search and enter the new value:

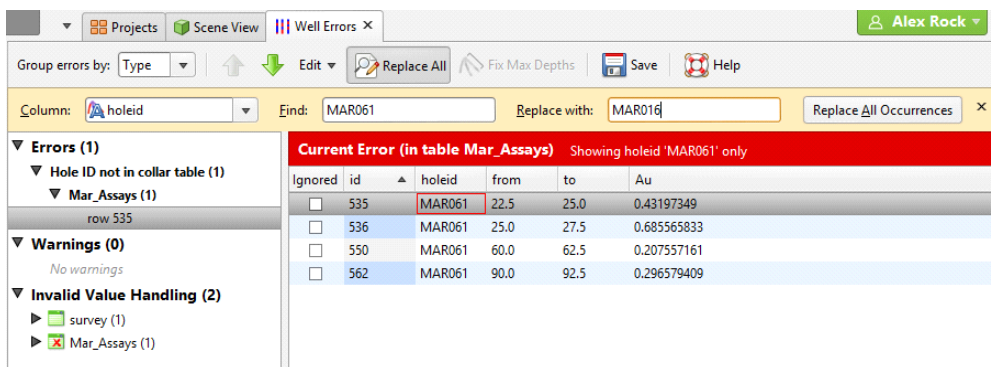

Click **Replace All Occurrences** to make the changes.

You can also select a number of rows and replace values in a selected column with a single value. To do this, use the Shift and Ctrl keys to select the rows you wish to edit, then click the **Edit** button and select **Write to Selected Rows**:

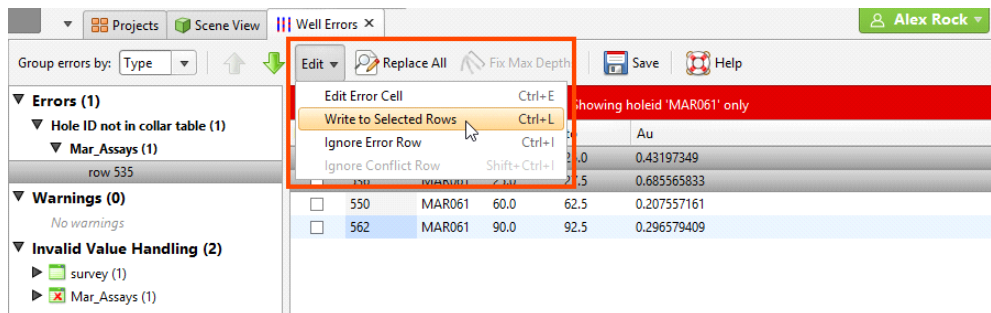

In the fields that appear, enter the **New value**, then click the **Write to Selected Rows** button:

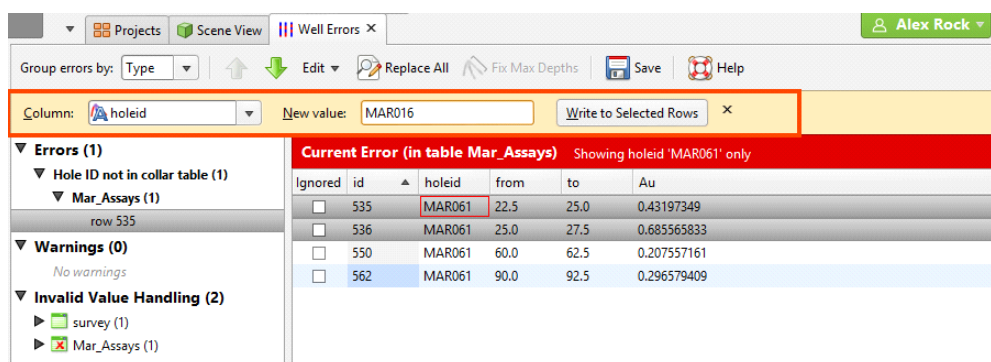

Common Errors and How to Fix Them

There are many possible sources of error in the data itself and you may be able to correct the errors directly in the **Errors** window. With well data, however, the message given in the **Errors** may actually point to an error elsewhere in the dataset, in which case you will need to open the other table from the project tree and edit it directly.

The errors and warnings described are:

- [Duplicate Points Error \(Points Tables\)](#)
- [Duplicate Hole ID Error](#)
- [Hole ID Not in Collar Table Error](#)
- [Collar Max Depth Error](#)
- [Invalid Max Depth Error](#)
- [From Depth Exceeds To Depth Error](#)
- [Overlapping Segments Error](#)
- [No Samples for Collars Warning](#)
- [No Surveys for Collar Warning](#)
- [Wedges Found Warning](#)

Duplicate Points Error (Points Tables)

Points tables will have **Duplicate Points** errors when rows have identical x, y and z values:

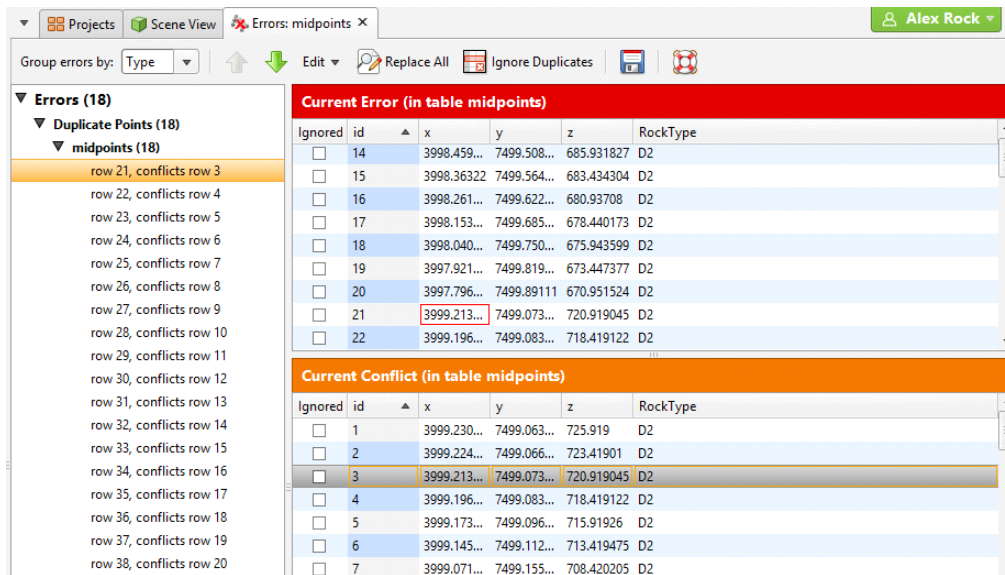

Tick **Ignored** for the rows you wish to ignore. If there are many duplicate points in the table, click the **Ignore Duplicates** button (🗑️). When you save the table, all duplicate rows will be marked as **Ignored**.

Duplicate Hole ID Error

Collar tables will have **Duplicate Hole ID** errors when collars have been assigned the same ID. Here, rows 4 and 5 have the same ID but are clearly different holes:

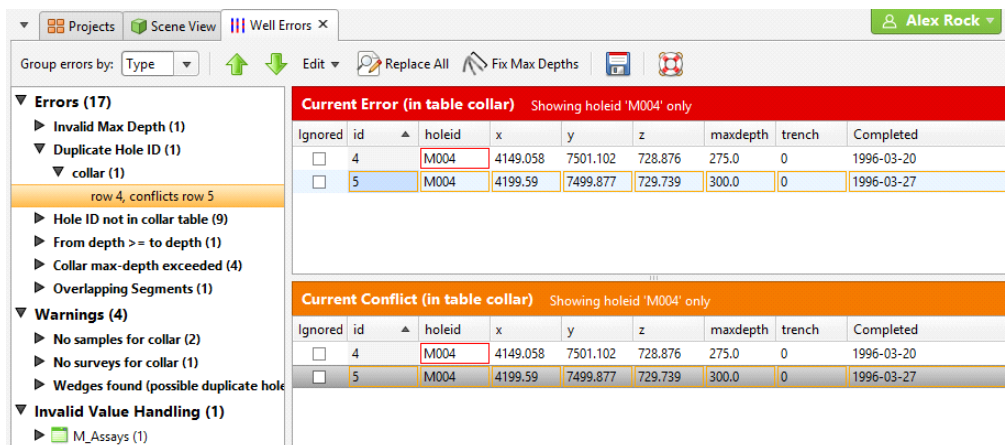

Changing the hole ID for one of the wells will correct the error. If the collar has been recorded twice by accident, tick the **Ignored** box for the duplicate collar.

Hole ID Not in Collar Table Error

Interval tables will have **Hole ID not in collar table** errors when the hole ID specified in the interval table is not found in the collar table.

The screenshot shows the 'Well Errors' window with a tree view on the left and a table of errors on the right. The tree view is expanded to 'M_Assays (4)' and 'row 415'. The table on the right is titled 'Current Error (in table M_Assays) Showing holeid 'M005' only' and contains the following data:

Ignored	id	holeid	from	to	Au
<input type="checkbox"/>	415	M005	0.0	2.5	0.02
<input type="checkbox"/>	416	M005	2.5	5.0	0.02
<input type="checkbox"/>	417	M005	5.0	7.5	0.02
<input type="checkbox"/>	418	M005	7.5	10.0	0.02
<input type="checkbox"/>	419	M005	10.0	12.5	0.132019027
<input type="checkbox"/>	420	M005	12.5	15.0	0.130456449
<input type="checkbox"/>	421	M005	15.0	17.5	0.714647081
<input type="checkbox"/>	422	M005	17.5	20.0	0.734139351
<input type="checkbox"/>	423	M005	20.0	22.5	0.48973995
<input type="checkbox"/>	424	M005	22.5	25.0	0.922992852
<input type="checkbox"/>	425	M005	25.0	27.5	1.570789879
<input type="checkbox"/>	426	M005	27.5	30.0	0.481513287

Affected intervals cannot be displayed. There are two possibilities for fixing this error:

- The collar table uses the wrong hole ID. Edit the collar table to correct the hole ID.
- The interval table uses the wrong hole ID. Use the **Replace All** tool to the incorrect values with the correct one. See [Replacing Values in a Column](#) above.

Collar Max Depth Error

Interval tables will have **Collar max-depth exceeded** errors when the **depth** values in the interval table exceeds the **maxdepth** value defined in the collar table. The **maxdepth** defined in the collar table is often a theoretical value established before drilling. If the **depth** value flagged as an error is not unrealistic, click on the **Fix Max Depths** button (🔧):

The screenshot shows the 'Well Errors' window with a tree view on the left and a table of errors on the right. The tree view is expanded to 'survey (1)' and 'row 31, column depth, conflicts c'. The table on the right is titled 'Current Error (in table survey) Showing holeid 'M015' only' and contains the following data:

Ignored	id	holeid	depth	dip	azimuth
<input type="checkbox"/>	30	M015	0.0	90.0	0.0
<input type="checkbox"/>	31	M015	550.0	80.0	300.0

This results in the collar table being updated with a maximum depth value that reflects the data in the interval tables.

Invalid Max Depth Error

Collar tables will have **Invalid Max Depth** errors when the **maxdepth** value is negative or non-numeric:

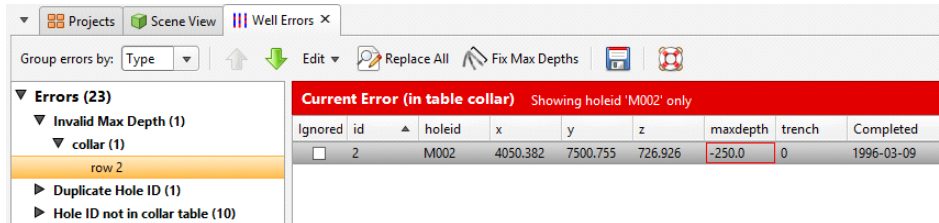

These errors are often the result of data entry mistakes and can be corrected by editing the table in the **Errors** window.

From Depth Exceeds To Depth Error

Interval tables will have **From depth > = to depth** errors when the **from** and **to** values in a row do not make sense:

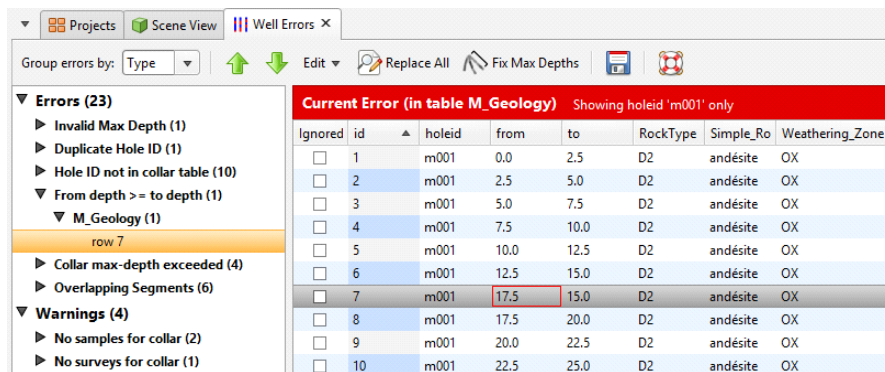

These errors are often the result of data entry mistakes and can be corrected by editing the table in the **Errors** window.

Until the error is corrected, the affected interval cannot be displayed, although all non-conflicting intervals will still be displayed for that well.

Overlapping Segments Error

Interval tables will have **Overlapping Segments** errors when intervals are in the same place for the same hole or when two holes are in the same place. Here, row 12 overlaps row 13 and the error can be corrected in the **Well Errors** window by entering the correct **to** value for row 12:

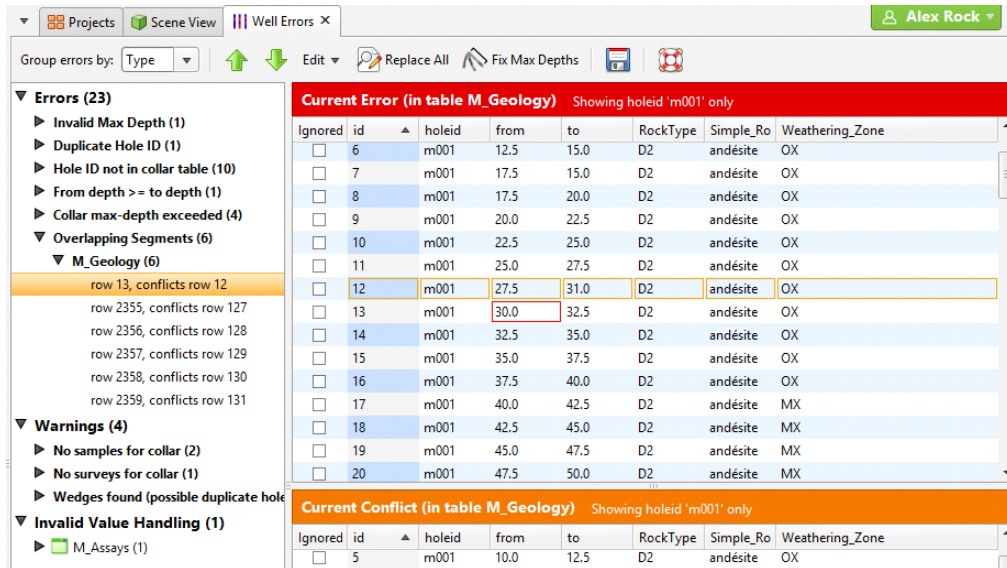

If an interval has been defined twice, click **Ignored** for one of the rows. Until the error is corrected, the affected intervals cannot be displayed, although all non-conflicting intervals will still be displayed for that well.

No Samples for Collars Warning

Interval tables will have **No values for Hole ID** warnings when there are no values in the interval table that correspond to a collar defined in the collar table. In this example, a hole called M090 has been defined in the collar table, but there is no data for it in the M_Assays table.

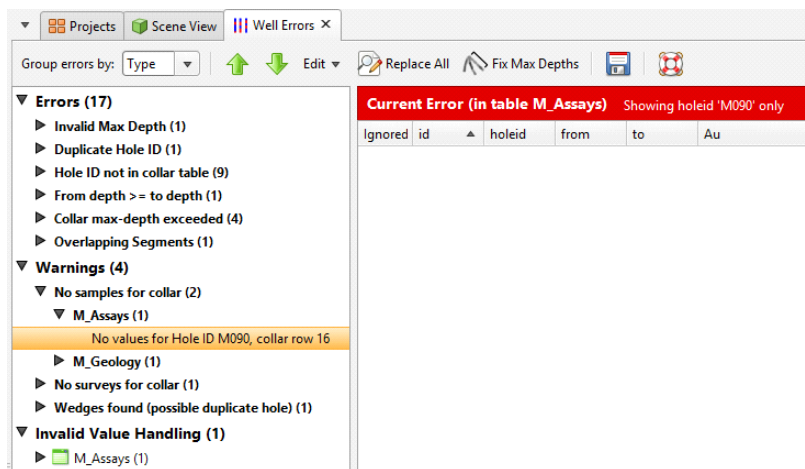

There are three possibilities:

- There are no values in this interval table for that collar. There is no need to do anything to remedy the warning as it will not affect further processing of the data.
- The collar table uses the wrong hole ID. This may be the case if there is also a **Hole ID not in collar table** warning listed. Edit the collar table to correct the hole ID.
- There are values for that collar in the interval table but they use the wrong collar ID. Again, there may also be a **Hole ID not in collar table** warning listed. Edit the interval table and correct the hole ID for the affected intervals.

No Surveys for Collar Warning

This survey table error is similar to **No Samples for Collars Warning** above: there are no values in the survey table that correspond to a collar defined in the collar table. Check that the collar table and the survey table are using the right hole ID. You will need to edit the survey table or collar table directly before this warning can be cleared.

Wedges Found Warning

Wedges found warnings occur in the collar table or in the survey table when wells appear to be duplicates because they are very close together in space.

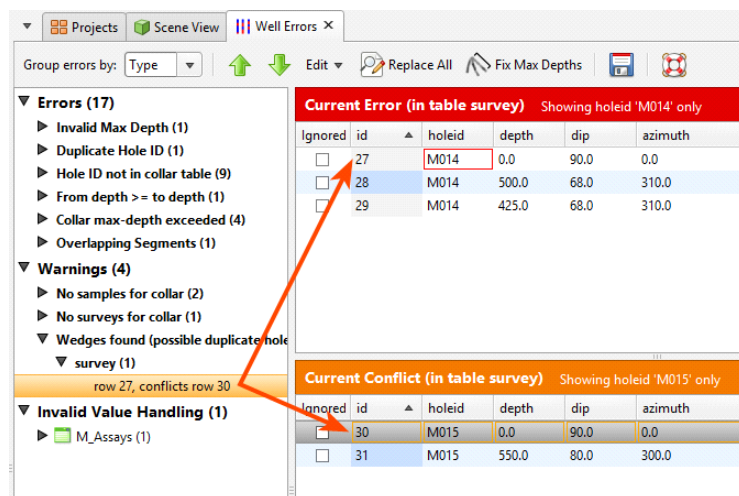

Leapfrog Geothermal flags wells that are less than 1° apart as possible duplicates; if you have two wells that are that close together, you may need to adjust the collar location of one of the wells to clear the warning. You can do this by editing the collar table.

Handling Special Values

Assay data often contains special values to represent different situations, such as grade values that are below a detection limit, cores that have been lost or segments that were not sampled. In addition, it is not uncommon for a well to contain some intervals that have no values.

When well data tables and points data are imported, Leapfrog Geothermal will mark columns containing non-numeric special values and missing intervals so that you can review these missing and non-numeric values and determine how Leapfrog Geothermal will handle them. For example, here numeric data columns that contain errors are marked with a red X:

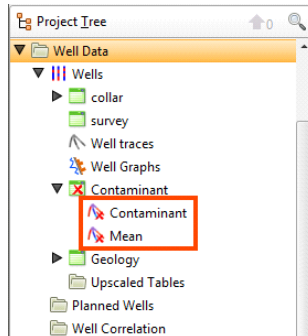

To review these errors, double-click on the column. The **Errors** window will appear with the error displayed for the selected column:

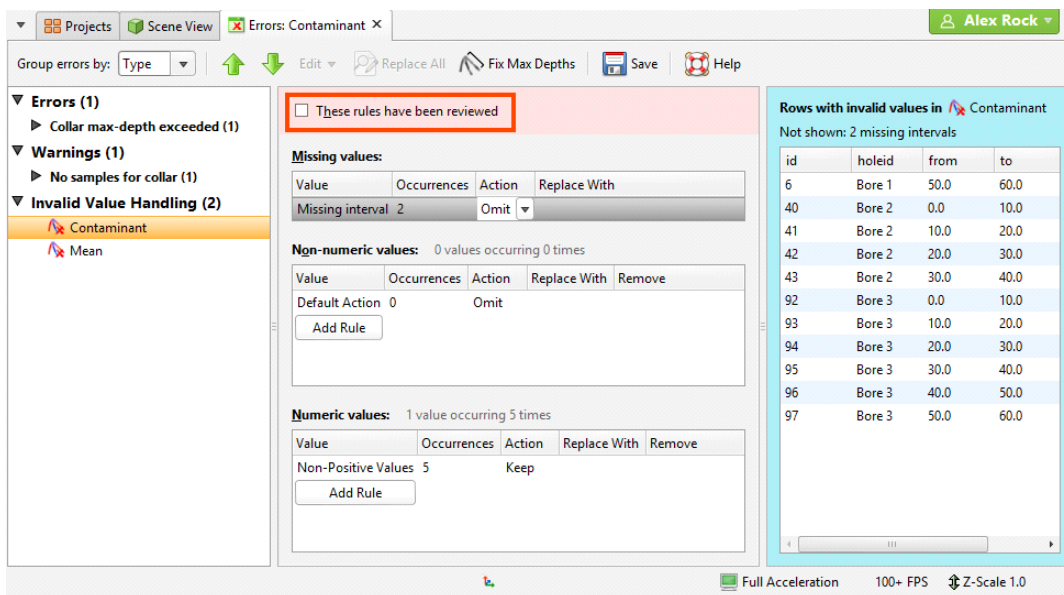

Leapfrog Geothermal will automatically set missing and non-numeric intervals to be omitted from further processing. Negative values are automatically set to **keep**. To change the **Action**, select another action from the list:

- Select **replace** to enter a numeric value to be used for further processing.
- Select **keep** to use a negative value in further processing.

For non-numeric and negative values, all values are initially treated as a single rule. However, if values have different meanings, you can define specific rules to determine how each value is handled. To do this, click on the **Add Rule** button. The window that appears will show the values present in the data. To define a new rule for a specific value:

- Select that value in the list.
- Tick the box for **The value I want is not in the list**.

- Enter the **Value**.
- Click **OK**.

In the **Invalid Value Handling** window, the value will be listed separately and you can choose the **Action** to apply.

Once you have reviewed the rules that will be applied to the column, tick the **These rules have been reviewed** box and click **OK**. The rules will be applied and used in further processing.

When you open a data table, the original values will be displayed. In all further processing of that data, the assigned special values will be used.

Boundaries

This topic discusses boundaries in Leapfrog Geothermal. It is divided into:

- [The Clipping Boundary](#)
- [Object Extents](#)
- [Extending a Surface](#)

A newly-created project has only a basic set of X-Y-Z coordinates, and the coordinate system used by the project is determined by the data imported to the project. It is not necessary to specify what coordinate system is used; however, it is necessary to ensure that data you import into the project uses the same coordinate system.

Often the best way to set the coordinates for the project as a whole is to import a map or aerial photo. Adding georeference data to a map will set the location of the map in three-dimensional space and set the coordinates for the project. See [Importing a Map or Image](#) for more information.

An important consideration in defining the project space is setting the clipping boundary. See [The Clipping Boundary](#).

It is not necessary to define a topography to model in Leapfrog Geothermal, but a defined topography can be used as an upper boundary for all models built in the project. See [Defining a Topography](#).

Part of creating many objects in Leapfrog Geothermal is defining the basic rectangular boundary that defines the object's extents. See [Object Extents](#).

You can modify the extents of geological models and interpolants using surfaces created from different types of data. See [Modifying a Geological Model's Boundary](#) and [Modifying an RBF Interpolant's Boundary with Lateral Extents](#).

The Clipping Boundary

An important consideration in defining the project space is setting the clipping boundary.

The default clipping boundary in a new project file encompasses everything in the project and grows as more data is added to the project. It is not necessary to set the clipping boundary.

However, the clipping boundary defines the limits of the X-Y coordinates for the region in which

data will be imported and models built and so defines the region in which calculations are made. Restricting the size of the clipping boundary limits the area in which calculations are made and is especially important if you are working with a large dataset.

The best way to set the clipping boundary is using an imported map or aerial photo, as this provides a visual reference that is helpful in working with data added to the project in the future. GIS data or well data can also be used to set the clipping boundary.

To set the clipping boundary, add to the scene the objects you wish to reference in setting the boundary. Right-click on the **Topographies** folder or on the **GIS Data, Maps and Photos** folder and select **Set Clipping Boundary**. The **Set Clipping Boundary** window will be displayed, together with controls in the scene you can use to resize the clipping boundary:

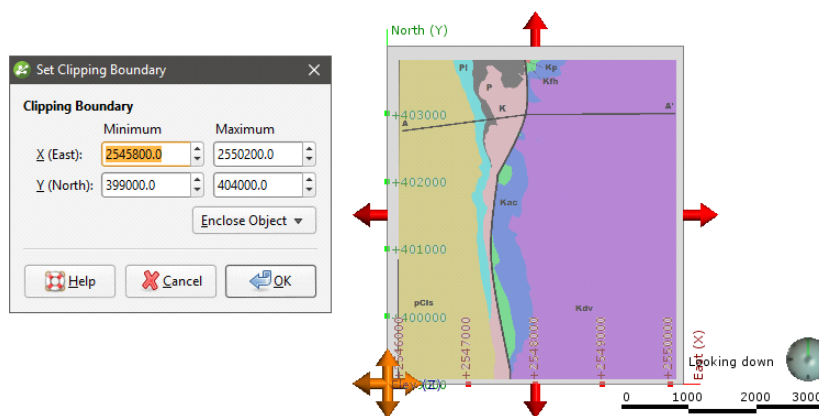

There are three ways to define the rectangular clipping boundary:

- Enter the coordinates.
- Select **Enclose Object** and choose from the list of objects in the project. The clipping boundary will be updated using the selected object.
- Use the controls that appear in the scene. The orange handle adjusts the corner of the clipping boundary and the red handles adjusts its size.

When you have finished adjusting the clipping boundary, click **OK**.

If you are going to import elevation data and use it to create a topography, it is important to set the clipping boundary before creating the topography. For example, here a map has been imported and a topography (yellow) created from an elevation grid. The map is displayed draped on the topography:

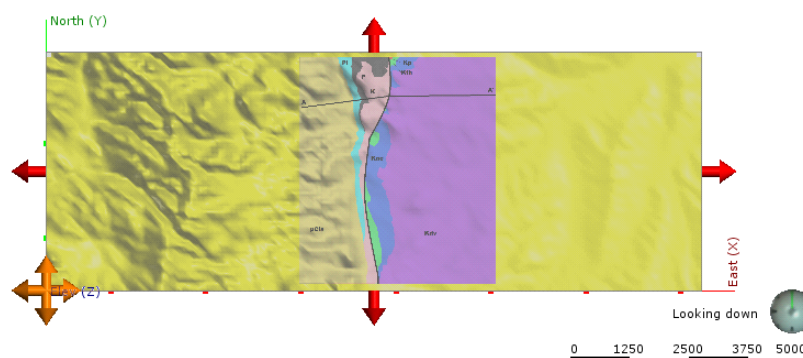

The red arrows and orange handle show the clipping boundary, which has been allowed to expand to encompass all data imported to the project. Because the topography was created before the clipping boundary was set, all the data in the imported elevation grid has been used and the resulting topography is larger than might be practical. Clearly, if the intention is to model within the area on the map, the clipping boundary should be limited to the region indicated by the map.

If the map is the only object in the project, it can easily be used to set the clipping boundary by selecting **<Everything>** from the **Enclose Object** list:

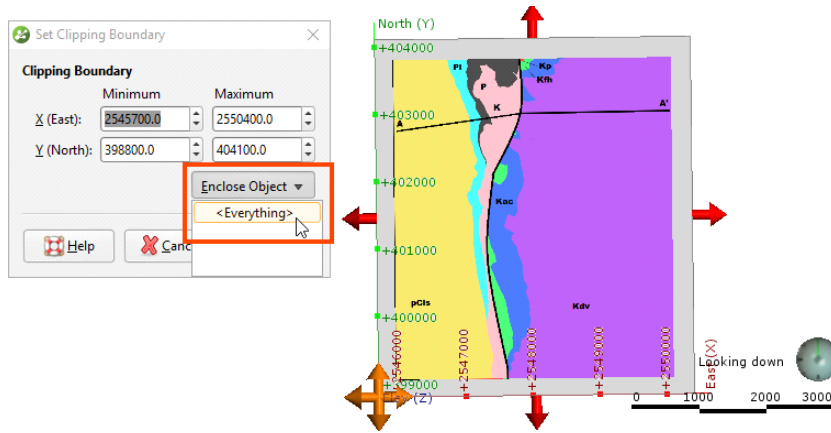

This results in a clipping boundary that is limited to the extents of the map:

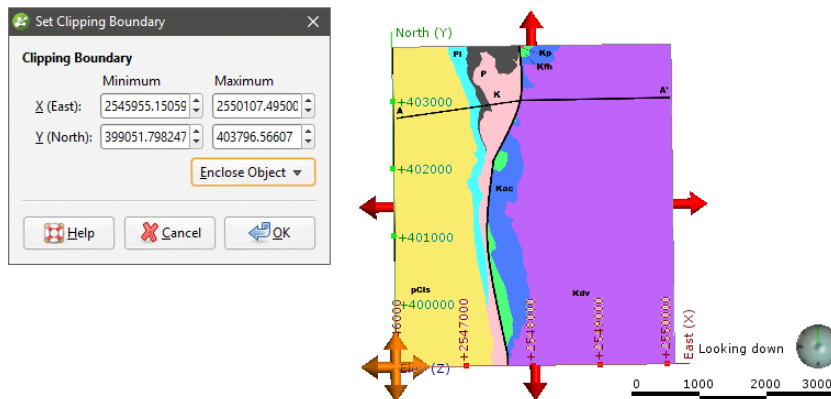

Once the clipping boundary has been set, further data imported into the project will be clipped to it. For example, importing the elevation grid and using it to create a topography only after the clipping boundary has been set to the map extents will result in a topography (with the map draped) that looks like this:

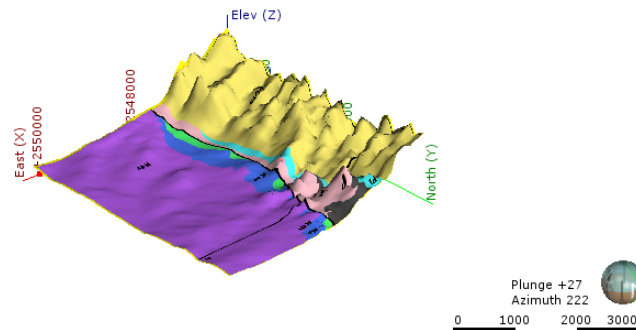

Once the clipping boundary has been set, a good next step is defining the topography. See [Defining a Topography](#).

Object Extents

Part of creating many objects in Leapfrog Geothermal is defining the basic rectangular boundary that defines the object's extents. There are generally two options for defining an object's extents:

- The first option is to define extents that are independent of other objects in the project. You can do this by entering coordinates or adjusting controls in the scene to set the size and shape of the extents. The new object's extents are fixed to the specified size. This is a good choice if, for example, you are building a geological model from a map and wish to define the model extents based on information on the map.
- The second option is to define extents based on other objects in the project. This is done by selecting the other object from the **Enclose Object** list that appears in many Leapfrog Geothermal screens.

For both methods, the new object's extents are fixed to the selected size. Using the **Enclose Object** list does not link the two objects; it is simply using the X-Y-Z coordinates of the original object as the basis for the new extents.

For example, here, a geological model's extents could be defined using the lithology segments used as the base lithology:

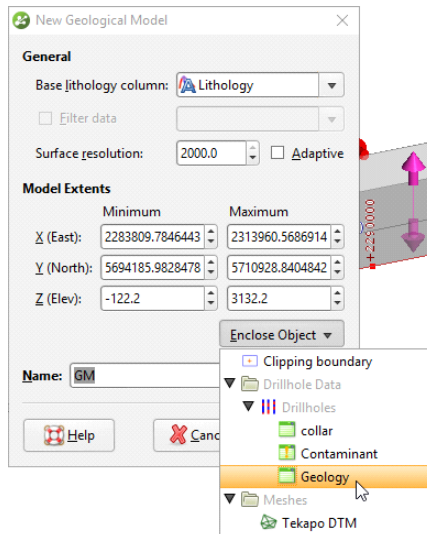

When creating some objects, you have the option of sharing extents with another object. This is the case with editable meshes (🌐), where you can choose whether the mesh has its own extents or shares extents with other objects in the project. Shared extents are updated when the original object's extents are updated.

If you are unsure about relationships between objects, expand them in the project tree to view more information. Here, two meshes have been defined from the same set of points:

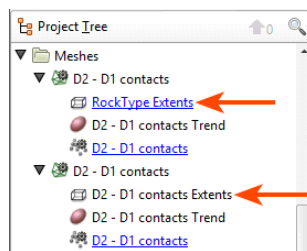

The first mesh shares its extents with another object in the project, which is indicated by the hyperlink. The second mesh has no hyperlink; it has its own extents that are not updated by other objects in the project.

Geological models and interpolants are created with a basic set of rectangular extents that can then be refined by adding extents created from other data in the project. Creating extents is a useful way of restricting modelling to a particular area of interest. For example, modelling can be restricted to a known distance from well data by applying a distance function as a lateral extent. See [Modifying a Geological Model's Boundary](#) for more information.

Extending a Surface

Geological models created in a Leapfrog Geothermal project automatically use the defined topography as an upper boundary. If a model is defined that extends outside the topography, an error will occur. A similar error occurs when surfaces used in geological models do not extend outside the model's extents. In all cases, Leapfrog Geothermal cannot process the surface and an error will be displayed.

In this example, an error has occurred during the process of creating a geological model because the topography (yellow) does not enclose the model extents (pink):

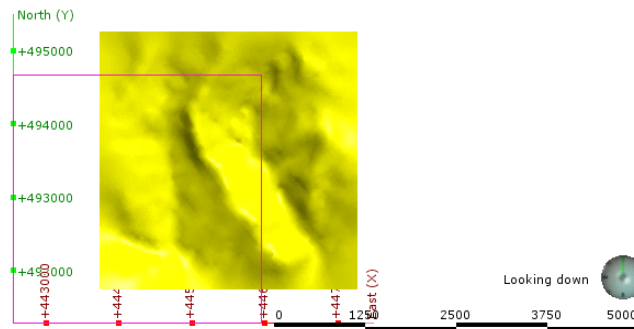

In order for Leapfrog Geothermal to be able to divide the model into separate volumes, the topography needs to be extended to enclose the model's boundary or the model's boundary needs to be restricted so it falls inside the topography. When the model is processed, the following error results:

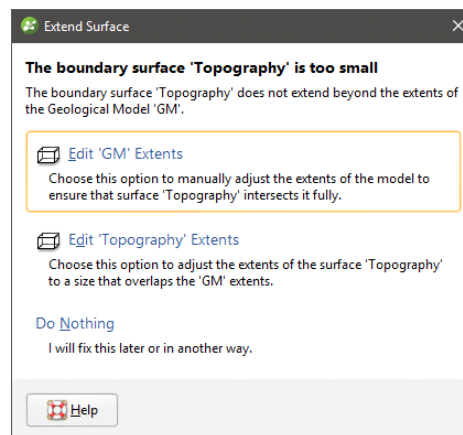

The solutions proposed will depend upon the data used to create the surfaces that conflict, but fall into three broad categories:

- Reduce the size of the model's or interpolant's extents. Click the **Edit Extents** button. This will open the object's **Boundary** window and you can change the boundary.
- Enlarge the topography by manually adjusting it. Click on the **Edit Topography Extents** button. This option is only available when the topography has been created from more than one data source. See [Adding Height Data to the Topography](#) and [Changing Topography Settings](#).
- Use the surface's vertices to create the boundary or contact with extents large enough to be used in the model or interpolant. Click the **Use Vertices** button to create a new vertices object and use it as the source data for the boundary or contact.

If you have a solution to the problem that is not covered by the options presented, click **Do Nothing**. For example:

- If the topography is not large enough, there may be additional data available. If it is not already in the project, import the data and add it to the topography as described in [Adding Height Data to the Topography](#).

- If a surface being used to define a contact surface or boundary in a geological model or interpolant is not large enough, you can add additional data to the surface.

Using vertices to create the boundary or contact results in the creation of a new points object that will be saved in the **Points** folder.

Earlier versions of Leapfrog Geothermal (up to 2.4) would automatically create the new vertices object and use it to interpolate the surface.

In the case of using topography vertices as an upper boundary, the vertices will be applied as a lateral extent and the defined topography will not be used. For example, here the geological model does not use the defined topography but instead uses the “GM: Topography” surface created from the vertices:

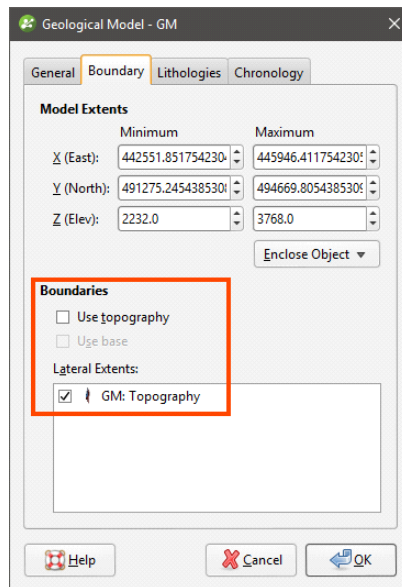

Using topography vertices can take some time to process.

An additional disadvantage to using vertices is that the vertices object created is not linked to the original object. When the object used to create the vertices changes, the vertices will not be updated.

Query Filters

Query filters can be used to select or view a subset of rows in a table. When used on a collar table, this amounts to selecting collars. When used on an interval table, measurement intervals are selected. Query filters can be used to model using a subset of data and to filter information displayed in the scene window.

A query can be created for any type of table in a project, including GIS data, points data and structural data.

When a query filter has been defined for an object and the object is displayed in the scene, the query filter can be applied by clicking on the object in the shape list and selecting the query filter in the shape properties panel:

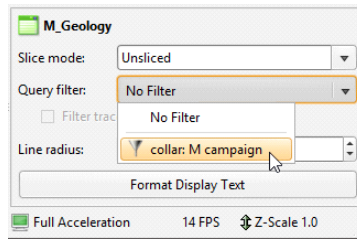

For a well data table, this displays only the data selected by the filter. The trace lines remain displayed in the scene. To filter trace lines, tick the **Filter trace lines** box:

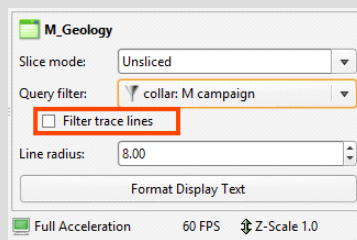

Query filters defined for collar tables are available to all other well data tables.

Creating a New Query Filter

To create a query filter, right-click on the required table in the project tree and select **New Query Filter**. The **Query Filter** window will appear:

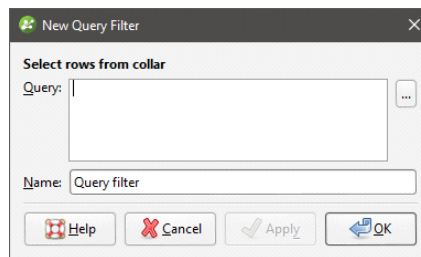

Type the required criteria into the **Query** box, using the query syntax described below. Press Ctrl-Enter for a new line in longer queries. Click the ... button for more advanced query building options, which are described in [Building a Query](#) and [Advanced Queries](#) below.

Assign the filter a name and click **OK** to save it. It will appear in the project tree under the table to which it applies. To apply a query filter to the scene, select the object in the shape list, then select the filter from the **Query filter** list in the shape properties panel:

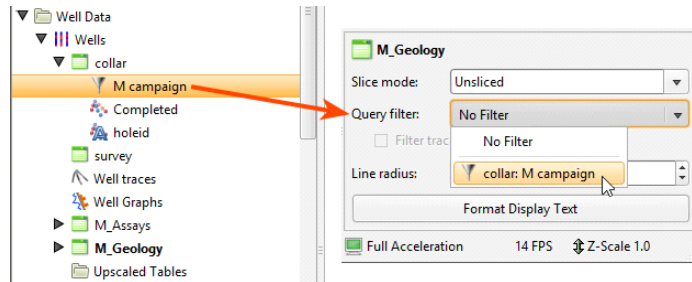

In this case, because the query filter was created for the collar table, it is also available for the lithology table.

Leapfrog Geothermal Query Syntax

The Leapfrog Geothermal query syntax is based on the WHERE clause of the Structured Query Language (SQL) with some restrictions:

- Unary operators are not allowed
- SQL functions cannot be used
- The SELECT statement should not be used (as in 'holeid in (SELECT holeid FROM ...)')
- Following statements are also prohibited: CASE, WHEN or MATCH

There is also one main SQL extension:

- IN and NOT IN will accept a partition group for the value list. E.g. 'zone IN layers.weathered' where "layers" is a partition of the "zone" column that has a group called 'weathered'.

These are some examples of valid Leapfrog Geothermal query statements:

- holeid in ('m-001', 'm-002')
- holeid not in ('m-001', 'm-002')
- holeid not like 'MAR%'

To enter a query that contains an apostrophe, enter two apostrophes. For example, the following query will result in an error:

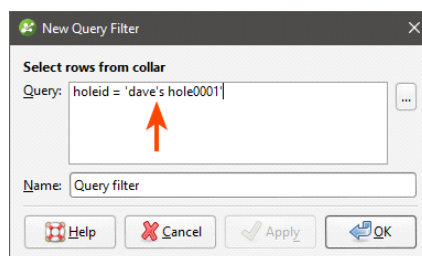

Adding the second apostrophe results in a valid query:

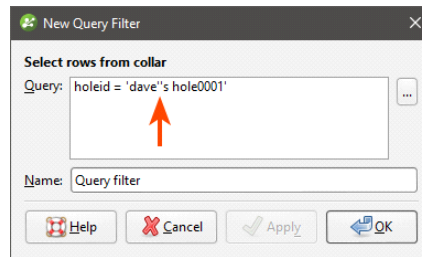

The **Query** box allows the following shortcut queries:

- Typing a single word will match all hole-ids starting with that string. For example, typing "MAR" is a shortcut for "holeid like 'MAR%'"
- Typing a comma-separated list of words will match all hole-ids that exactly match the given words. For example typing "M001, M002" is a shortcut for "holeid in ('M001', 'M002)'"

Building a Query

Many common queries can be built using the **Build Query** window:

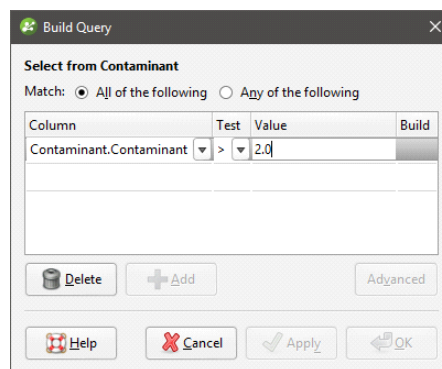

This window aims to be easy to use rather than comprehensive in its support for the full Leapfrog Geothermal query syntax. For more advanced queries, click on the **Advanced** button. See [Advanced Queries](#) for more information.

To add a criteria, click **Column** to view a list of columns available in the table. Select a **Test** and enter a **Value**. What can be entered for the **Value** depends on the type of column and test selected.

Quotes are not required around text values entered in the value column as they are in SQL. Leapfrog Geothermal will add quotes and brackets to the value "MX, PM" to make a valid SQL list of strings "('MX', 'PM')" when the query is saved.

Click on the **Apply** button to apply to query to the context in which the dialog was opened.

Use the **Delete** button to delete the criteria in the selected row and the **Add** button to add a blank row.

Advanced Queries

The **Advanced Query** window provides a powerful and flexible query building using the Leapfrog Geothermal query language.

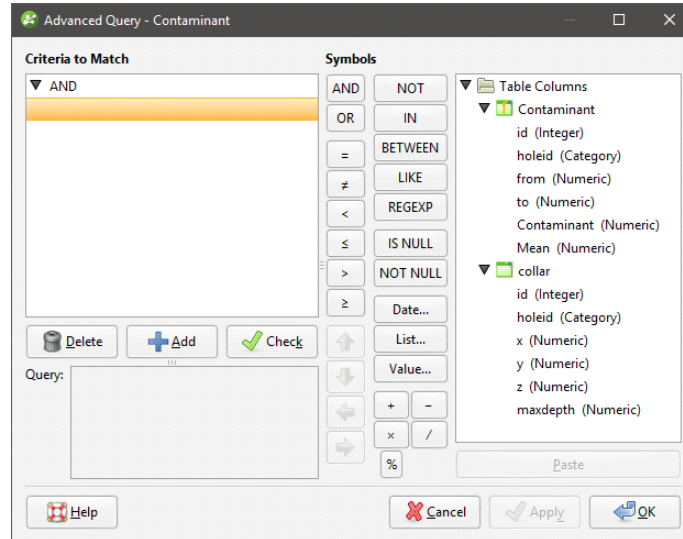

Enter the query in the **Criteria to Match** area on the left. The query is displayed as a tree structure with AND and OR terms as the branch nodes and conditions as the leaves. Use the **Delete** button to delete a row from the query and the **Add** button to add a blank row. The **Check** button can be used at any time to check if the current query statement is valid. Below the buttons is a box showing the raw SQL form of the query.

Except for the arrow buttons, the buttons down the middle of the dialog are used for entering values into the query. The arrow buttons are used for moving the currently selected criteria to a different position in the query. The **Date**, **List** and **Value** buttons will open a builder dialog for the column selected in the current row. If there is no column found or the column is of the wrong type, an error message is displayed.

The tree on the right contains all the columns available to the query. Double-click on a column name to insert it into the query.

Defining a Topography

It is not necessary to define a topography to model in Leapfrog Geothermal, but a defined topography can be used as an upper boundary for all models built in the project.

A key advantage of defining a topography is that it provides consistent elevation data for objects imported to and created in the project. The quality of elevation information can be poor compared to X- and Y-coordinates, which can create problems when using objects to build a model. A topography can be created from the most reliable elevation data, and other objects can have elevation set from this topography.

An important consideration when defining the topography is ensuring that it is large enough to encompass the models you will be building in the project. If you create a small topography but then later create a model that extends outside the topography, you will need to enlarge the

topography, which can result in considerable reprocessing of all objects in the project that use the topography as a boundary. See [Extending a Surface](#) for more information.

This topic describes creating and working with a topography. It is divided into:

- [Topography From Elevation Grid](#)
- [Topography From Surfaces, Points or GIS Vector Data](#)
- [Fixed Elevation Topography](#)
- [Adding Height Data to the Topography](#)
- [Changing Topography Settings](#)
- [Topography Display Options](#)
- [Projecting Collars onto the Topography](#)

The topography can be created from an imported elevation grid, points data, surfaces and GIS data. It is not necessary to decide on a single source of information, as information can be combined, and you can add and remove data as required.

Once defined, you can export the topography as a mesh or as an elevation grid. See:

- [Exporting Meshes](#)
- [Exporting an Elevation Grid](#)

Topography From Elevation Grid

There are two ways to create the topography from an elevation grid:

- Right-click on the **Topographies** folder and select **New Topography > Import Elevation Grid**. Import the grid as described in [Importing an Elevation Grid](#).
- Import the grid using the **Meshes** folder and then right-click on the **Topographies** folder and select **New Topography > From Surface**.

Enter a name for the topography and click **OK**. A hyperlink to the elevation grid will appear in the **Topographies** folder under the defined topography.

Once the topography has been defined, additional height data can be added by right-clicking on the topography and selecting from the options available. See [See "Adding Height Data to the Topography"](#) for more information.

Topography From Surfaces, Points or GIS Vector Data

To create the topography from a surface, points or GIS data, first import the data into the project.

- Import surfaces into the **Meshes** folder.
- Import well data into the project or points data into the **Points** folder.
- Import GIS vector data into the **GIS Data, Maps and Photos** folder.

Next, right-click on the **Topographies** folder and select one of the **New Topography** options. A list of suitable objects available in the project will be displayed. Select the required object and click **OK**. Enter a name for the topography and click **OK**. A hyperlink to the source object will appear in the **Topographies** folder under the defined topography.

Once the topography has been defined, additional height data can be added by right-clicking on the topography and selecting from the options available. See [See "Adding Height Data to the Topography"](#) for more information.

See also [Changing Topography Settings](#) below.

Fixed Elevation Topography

If you don't have any data suitable for creating a topography, you can set a fixed elevation. To do this, right-click on the **Topographies** folder and select **New Topography > Fixed Elevation**. In the window that appears, enter a value for the elevation and click **OK**. Enter a name for the new topography and click **OK**.

The new topography will appear in the project tree under the **Topographies** folder.

Once a topography has been defined, the only way to set a fixed elevation is to remove the objects that have been used to define the topography. To do this, right-click on the hyperlinked object and click **Remove**. You will then be able to set a fixed elevation for the topography.

Adding Height Data to the Topography

When creating the topography, it is not necessary to decide on a single source of information, as information can be combined. Once the topography has been defined, additional height data can be added by right-clicking on the topography and selecting from the options available:

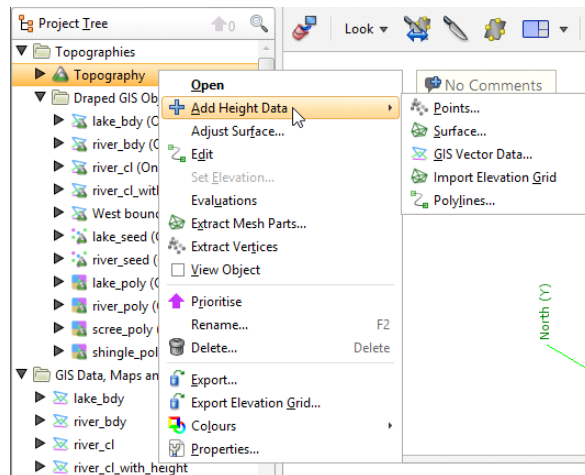

It is not possible to add structural data or polylines with orientation information to the topography. If you edit the topography with a polyline, your options for editing the polyline will be limited.

For points, surfaces and GIS vector data, you will be prompted to select from the data sources available in the project. For an elevation grid, see [Importing an Elevation Grid](#).

All data objects used to define the topography will appear under the topography, hyperlinked to their parent objects:

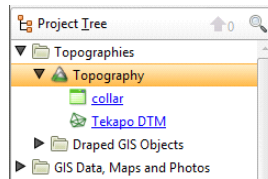

When you have added data to the topography, you may need to enlarge the topography extents. See [Changing Topography Settings](#) below.

To remove data objects from the topography, either:

- Delete the object from the topography. To do this, right-click on the hyperlinked object and click **Remove**.
- Delete the object from the project. If you choose this option, consider carefully the effects on other objects in the project, as once an object is deleted, it cannot be recovered.

When the topography is defined from multiple objects, you can set the resolution of the topography by double-clicking on it. See [Changing Topography Settings](#) below.

Changing Topography Settings

When the topography is created from points or GIS data or when the topography is created by combining data, you can change its boundary and resolution and apply a trend. To do this, double-click on the topography in the project tree. The **Edit Topography** window will appear:

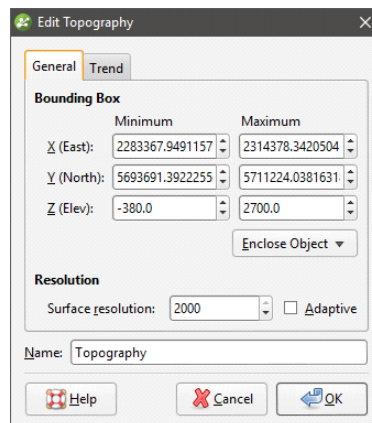

Changing the Size of the Topography

In the **General** tab, you can change the topography extents. Use the controls in the scene or enter the required values in the **Bounding Box** fields.

Topography Resolution

The resolution of the topography depends on how it was created.

- When the topography is created from a single mesh, the resolution of the topography is set from the resolution of the mesh and can only be changed when the mesh is imported. If you wish to change the resolution of the topography, you must first add more height data to the topography. See [Adding Height Data to the Topography](#).
- When the topography is created by setting a fixed elevation, the resolution cannot be set.

When the topography is created from points or GIS data or when the topography is created from combining data, you can set its resolution in the **Edit Topography** window.

When you set a specific **Surface resolution** without enabling the **Adaptive** option, the triangles used will be the same size for the whole topography. When you enable the **Adaptive** option, the resolution of the topography will be affected by the availability and density of real data. See [Surface Resolution in Leapfrog Geothermal](#) for more information on these settings.

Applying a Trend to the Topography

In the **Trend** tab, you can apply a trend to the topography:

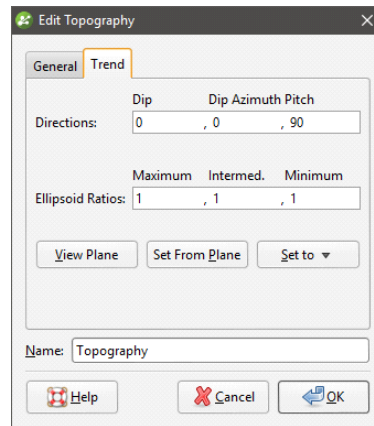

See [Global Trends](#) for more information.

Topography Display Options

To display the topography in the scene window, either:

- Right-click on the topography in the project tree and select **View Object**.
- Click on the topography object and drag it into the scene.

The topography will be displayed in the scene window and in the shape list:

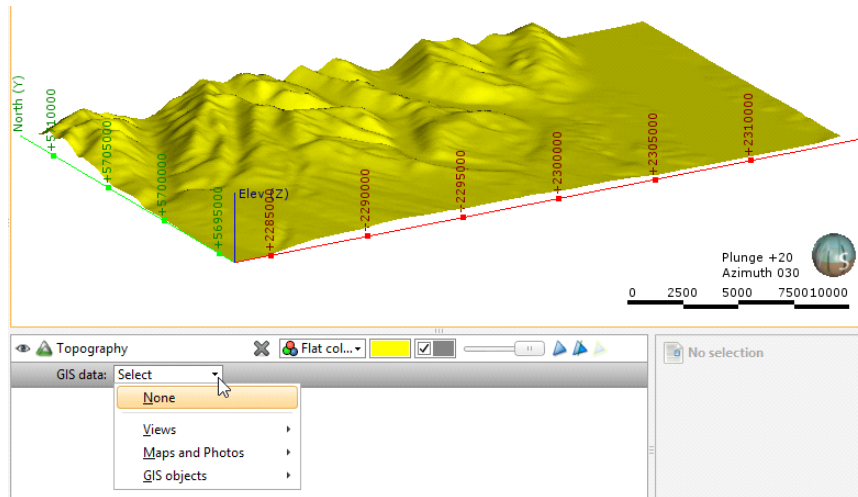

The topography object in the shape list provides additional controls that can be used to change the way the topography is displayed and highlight features of interest. For example, selecting an imported map from the list results in it being displayed draped onto the topography:

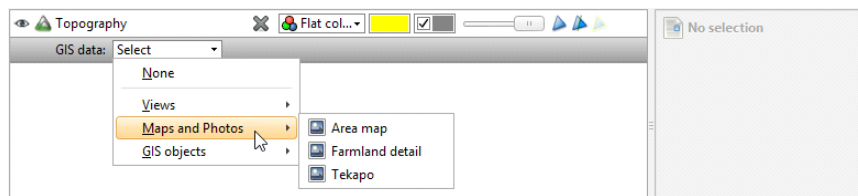

The list is organised into:

- **Views.** This contains options for creating and editing custom topography views and also lists any views already defined. With custom topography views, you can view multiple GIS objects, maps and contours. See [Custom Topography Views](#) for more information.
- **Maps and Photos.** This lists all images stored in the **GIS Data, Maps and Photos** folder.
- **GIS objects.** This lists all GIS data objects stored in the **GIS Data, Maps and Photos** folder.

Projecting Collars onto the Topography

If the collars are not lying on the topography, Leapfrog Geothermal can make adjustments to the collar depth values so that the collars lie on the topography. This adjustment is reversible.

To make this adjustment, right-click on the collars table and tick the box for the **Project Collars Onto Topography** option. If you then open the collar table, the depth values will reflect the topography. Right-click on the collar table and untick the box for **Project Collars Onto Topography** to return to the uncorrected collar depth values.

GIS Data, Maps and Images

Often the first data imported into a new project is information that sets the coordinates for the project as a whole. This includes GIS data, maps, aerial photos and 2D grids. This section describes importing and working with GIS data and images.

You can view the attribute table for most GIS data objects by right-clicking and selecting **Attribute Table**. You can also create query filters that can be used when displaying the GIS object. See the [Query Filters](#) topic for more information.

If, during the course of a project, GIS data changes, it can be reloaded and models that are dependent on that data will automatically be updated.

Displaying GIS Data

In Leapfrog Geothermal, there are three ways of viewing GIS data:

- In its "native" form, as it was imported to the project. Add the GIS data object to the scene as you would any other object.
- On the topography. GIS data objects added to a project are automatically projected onto the topography and saved in the **Topographies > Draped GIS Objects** folder. Add the draped GIS object to the scene.
- Combined with other data draped on the topography. See [Custom Topography Views](#) below.

The reason for having different ways of displaying GIS data is the difficulty posed by inconsistent height data. Not all height data is correct or wanted. In practice, it is important for all the data to be consistent. For this reason, a single elevation field is defined as part of the topography and available data is assigned heights from this object. The native height information is available and can be used to define the height of layers in the models.

Custom Topography Views

In Leapfrog Geothermal, topography can be displayed with any of the GIS data and images available in the project. With a custom view, you can display multiple GIS data objects, maps and aerial photos.

To create a custom view, add the topography object to the scene. Select **Views > Edit views** from the **GIS data** list:

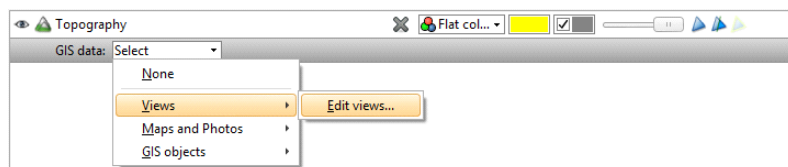

The **Edit GIS Views** window will appear. Click **New** to create a new view. Enter a name for the new view and click **Create**:

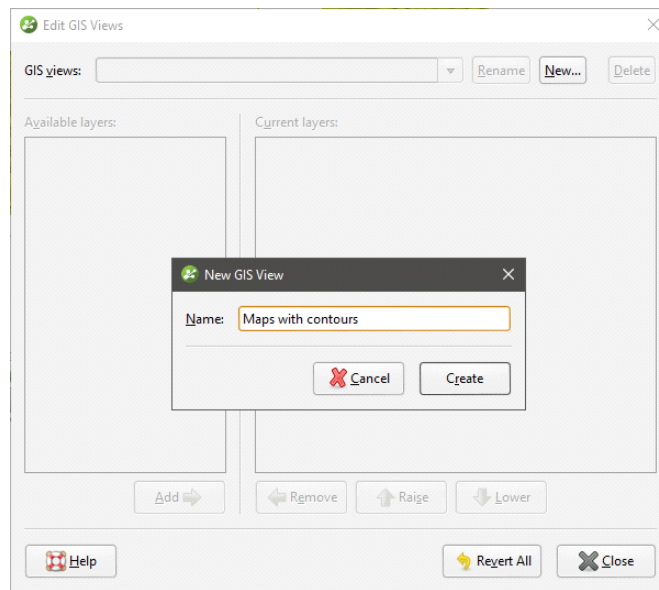

The new view will be created in the **Edit GIS Views** window, together with a list of **Available layers**. Click the **Add** button to move layers into the **Current layers** list and use the **Raise** and **Lower** buttons to arrange them:

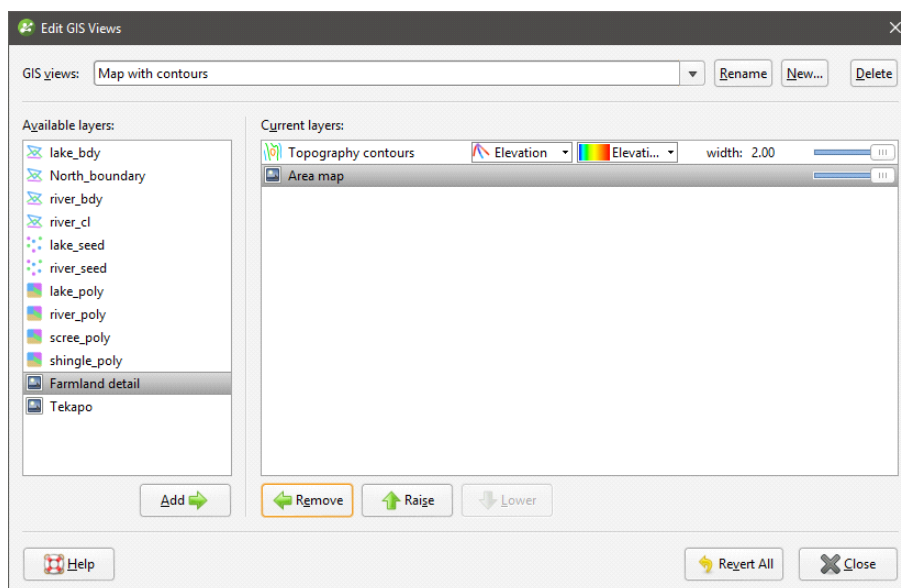

Use the transparency and point and line size controls to emphasise data.

Click **Close**. The topography will be displayed in the scene with the new view applied:

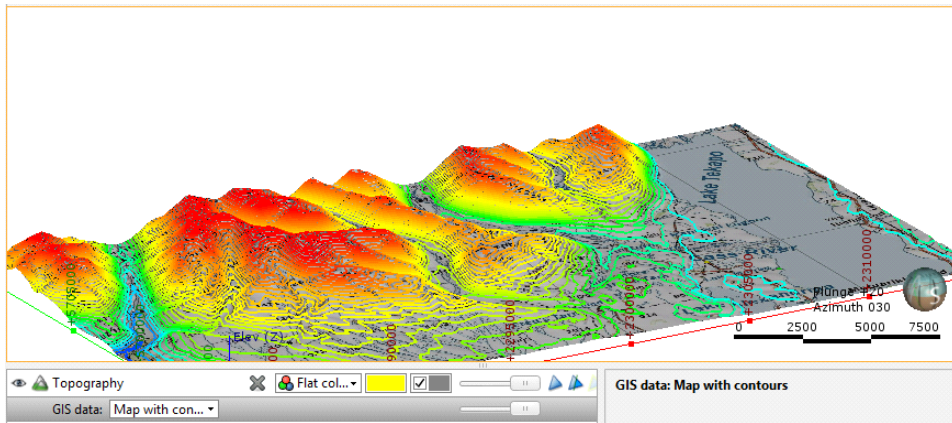

Importing Vector Data

Vector data formats Leapfrog Geothermal supports include:

- Shape Files (*.shp)
- MapInfo Files (*.tab, *.mif)
- ESRI Personal GeoDatabase Files (*.mdb, *.acbdb)

You can also import data from MapInfo and ESRI databases. See [Importing a MapInfo Batch File](#) and [Importing Data from an ESRI Geodatabase](#) for more information.

To import vector data, right-click on the **GIS Data, Maps and Photos** folder and select **Import Vector Data**. Navigate to the folder that contains the GIS data and select the file. You can select multiple files using the Shift and Ctrl keys.

Click **Open** to begin importing the data.

If you are importing a single file, the **Import GIS Vector Data** window will show a summary of the data in the selected file:

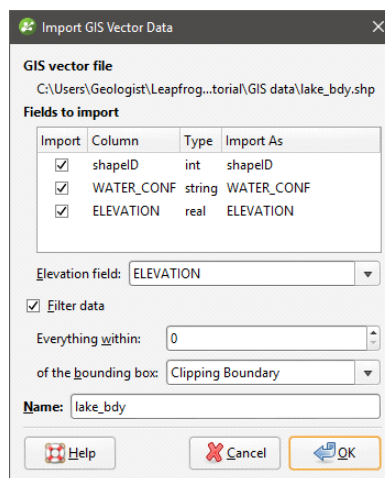

You can choose what field in the data to use for the **Elevation Field** from the list.

If you are importing multiple files, all files being imported are listed in the **Import GIS Vector Data** window and no summary of each file is displayed:

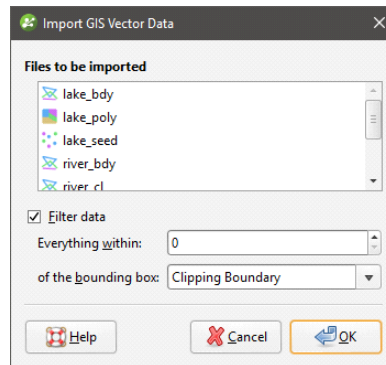

Data is automatically clipped to the clipping boundary, but you can change how the data is filtered to suit any bounding box that exists in the project. If you do not wish to clip the data, untick the **Filter data** box.

Click **OK** to add the data to the project. The object or objects will appear in the project tree under the **GIS Data, Maps and Photos** folder. If a topography has been defined for the project, the imported GIS data objects will automatically be projected onto the topography and saved in the **Topographies > Draped GIS Objects** folder.

You can then view an object's attributes by right-clicking on it and selecting **Attribute Table**.

When importing files, you may be prompted to select whether or not to filter elevation data. If you wish to use another data source for your elevation data, select **Filter data**. For example, if you import a GIS line that has suspect elevation data, you can discard the elevation data and set the elevation from the topography, as described in [Setting Elevation for GIS Objects and Images](#).

If data changes outside the project, it can be reloaded as described in [Reloading GIS Data](#).

Importing a MapInfo Batch File

You can import a collection of GIS data exported from MapInfo. The MapInfo file can include points, lines, polygons, images and elevation grids.

To import GIS data in this way, right-click on the **GIS Data, Maps and Photos** folder and select **Batch Import > from MapInfo**. In the window that appears, navigate to the folder that contains the MapInfo batch file, which is an XML file. Click **Open**.

The data that can be imported will be displayed and you can select which files to import:

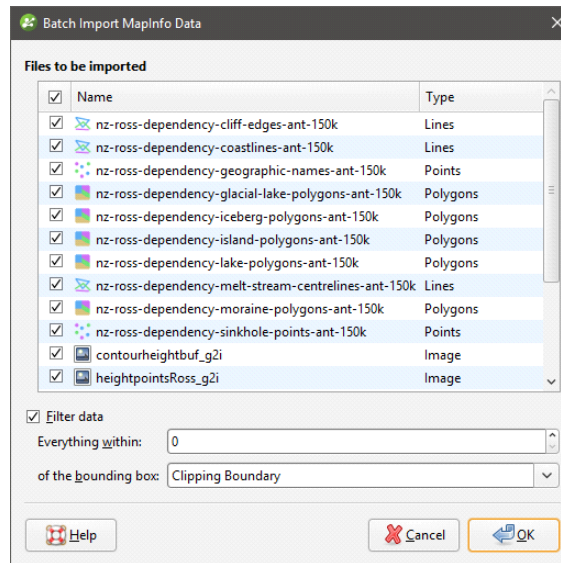

You can select multiple files using the Shift and Ctrl keys.

Data is automatically clipped to the clipping boundary, but you can change how the data is filtered to suit any bounding box that exists in the project. If you do not wish to clip the data, untick the **Filter data** box.

Click **OK** to import the selected files, which will be added to the **GIS Data, Maps and Photos** folder as a group (📁), with the exception of elevation grids, which will be added to the **Mesher** folder.

Points, lines and polygons can be reloaded on an individual basis, which is described in [Reloading GIS Data](#).

Importing Data from an ESRI Geodatabase

You can import points, lines and polygons from an ESRI geodatabase. However, the import of raster data is not supported.

To import GIS points, lines and polygons in this way, right-click on the **GIS Data, Maps and Photos** folder and select **Batch Import > from ESRI Geodatabase**. In the window that appears, navigate to the folder that contains the database and click **Open**.

Leapfrog Geothermal imports uncompressed ESRI geodatabases.

The data that can be imported will be displayed and you can select which files to import:

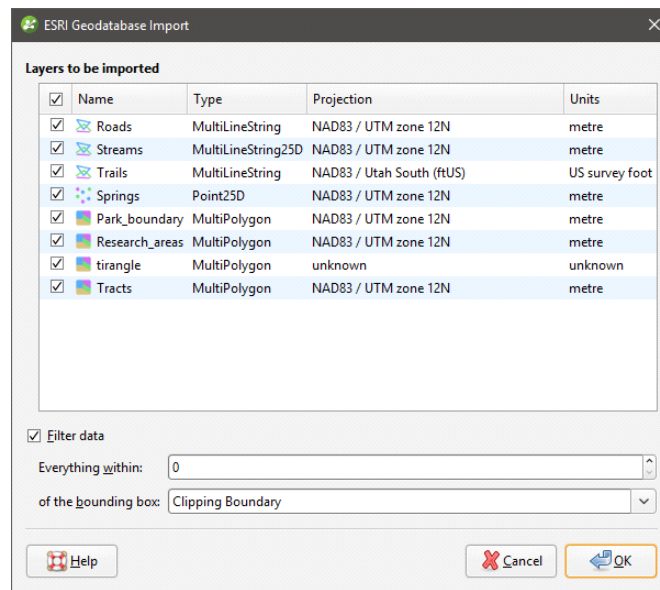

You can select multiple files using the Shift and Ctrl keys.

Data is automatically clipped to the clipping boundary, but you can change how the data is filtered to suit any bounding box that exists in the project. If you do not wish to clip the data, untick the **Filter data** box.

Click **OK** to import the selected files, which will be added to the **GIS Data, Maps and Photos** folder as a group (🗂️). Data in the group can be reloaded individually or as a group, which is described in [Reloading GIS Data](#).

Reloading GIS Data

If during the course of a project GIS points, lines and polygons change, they can be reloaded and dependent models will automatically be updated. Objects originally imported as part of an ESRI database (🗂️) can be reloaded individually or as part of the group.

Although the GIS data will be overwritten, any elevation data set in Leapfrog Geothermal will be retained.

Reloading Points, Lines and Polygons

To reload a GIS point, line or polygon, right-click on it in the project tree and select **Reload Data**. Navigate to the folder containing the GIS file and select the file. Click **Open**.

The process is the same as importing GIS data. Click **OK** to reload the data. The original data will be overwritten and dependent objects will be updated to reflect the new data.

Reloading an ESRI Database

To reload an ESRI database, right-click on it in the project tree and select **Reload Data**. In the window that appears, select the layers to reload, then click **OK**.

Points, lines and polygons imported as part of an ESRI database can also be reloaded on an individual basis.

2D Grids

Leapfrog Geothermal imports the following 2D grid formats:

- Arc/Info ASCII Grid (*.asc, *.txt)
- Arco/Info Binary Grid (*.adf)
- Digital Elevation Model (*.dem)
- Intergraph ERDAS ER Mapper 2D Grid (*.ers)
- ESRI .hdr Labelled Image (*.img, *.bil)
- SRTM .hgt (*.hgt)
- Surfer ASCII or Binary Grid (*.grd)

2D grids can also be imported from MapInfo files. See [Importing a MapInfo Batch File](#) for more information.

To import a 2D grid, right-click on either the **Geophysical Data** folder or the **GIS Data, Maps and Photos** folder and select **Import 2D Grid**. Navigate to the folder that contains grid and select the file. Click **Open** to begin importing the data.

The **Import 2D Grid** window will appear, displaying the grid and each of the bands available. Select the data type for each band and set the georeference information, if necessary. See [Importing a Map or Image](#) for information on georeferencing imported files.

Once the grid has been imported, you can set its elevation, which is described in [Setting Elevation for GIS Objects and Images](#).

When you display the grid in the scene, select the imported bands from the shape list:

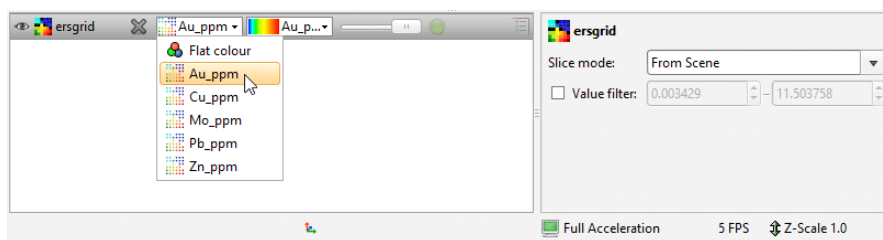

Grids can be displayed as points (●) or as cells and the values filtered, as described in [Displaying Points](#).

Importing a Map or Image

Image formats Leapfrog Geothermal supports include:

- PNG Files (*.png)
- JPEG Files (*.jpg, *.jpeg)
- TIFF and GeoTIFF Files (*.tiff, *.tif)
- Windows Bitmap Files (*.bmp)
- Graphics Interchange Format Files (*.gif)

Images larger than 16384 by 16384 pixels will be scaled down. Reducing your images in size below this limit will avoid scaling; you can do this by cropping the image during the import process or by scaling down the image in an external image editor.

If the file contains georeference information, it too will be imported.

To import a map or image, right-click on the **GIS Data, Maps and Photos** folder and select **Import Map**. Navigate to the folder that contains the image and select the file. The **Import Image** window will be displayed:

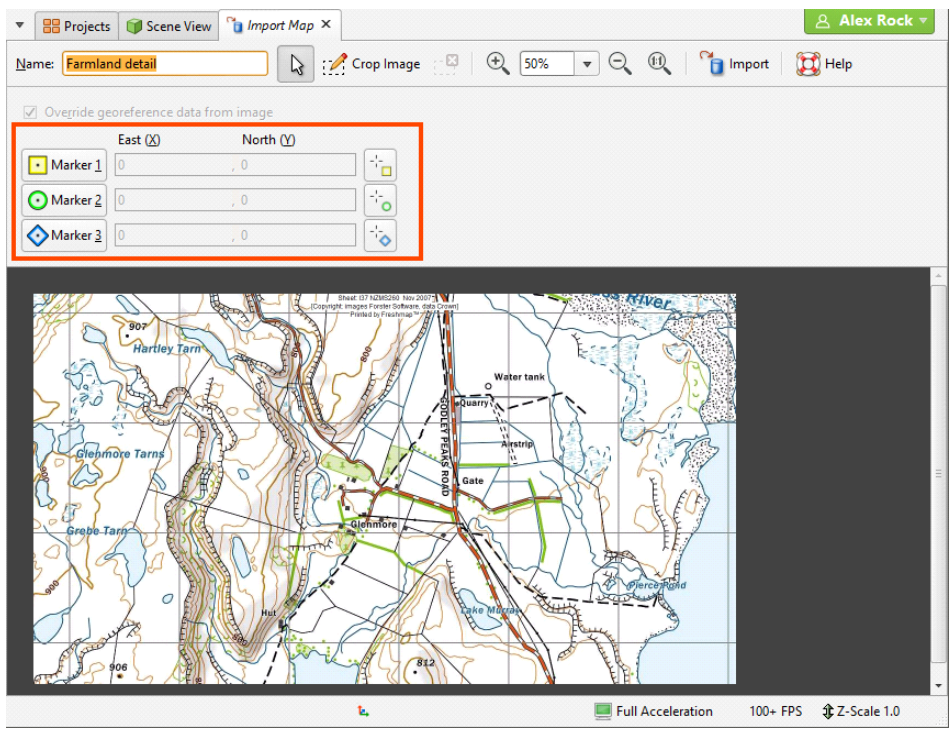

The rest of this topic describes georeferencing images. It is divided into:

- [Manual Georeferencing](#)
- [Automatic Georeferencing](#)
- [Exporting a Georeferenced Image](#)

Adding georeference data to a map will set the location of the map in the three-dimensional viewer. It is often used as a first step in setting the coordinates for the project as a whole.

The three reference markers (📍, 🟢, 🔵) are used to set coordinates for the image in the scene. If the image is the first object added to the project, this will, in effect, set the coordinate system for the project. The scene markers (📍, 🟢, 🔵) let you copy georeference information from the scene.

Cropping the image to only the area of interest will reduce video RAM usage and may improve graphics performance. To crop the image, click on the **Crop Image** button (📏) at the top of the window, then drag around the part of the image you wish to use. Click on the **Remove Crop** button (🗑️) to clear the cropping.

Manual Georeferencing

If the image does not contain georeference information, you will need to add it manually by adding the three reference markers (📍, 🟢, 🔵) to the image. To select a marker, click on its marker button (**Marker 1**, **Marker 2** or **Marker 3**), then move it to the required location on the image using the mouse or the arrow keys.

Once each marker is correctly positioned, enter the real-world X and Y coordinates for each marker:

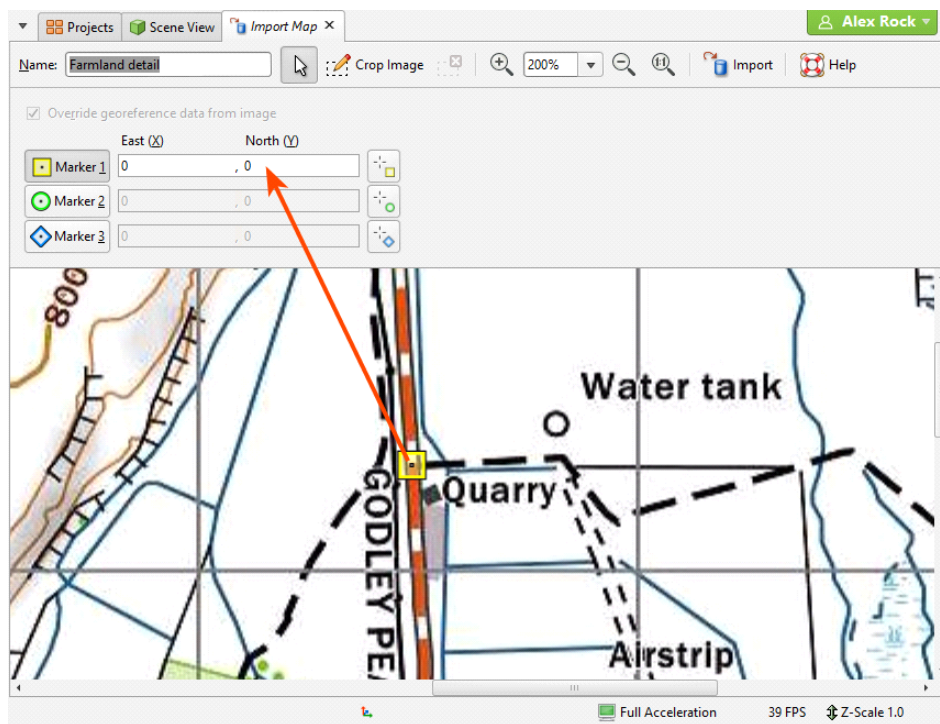

There are two ways to do this:

- Enter the coordinates for each marker in the **East (X)** and **North (Y)** fields. As you enter the coordinates, the positions of the markers will be displayed in the scene.
- Copy coordinates from the scene using the three scene markers (📍, 🟢, 🔵).

The second method is useful when you already have other objects correctly georeferenced in the project. For example, if you have a larger map in the project and wish to import a more detailed map, you can copy the coordinates from the georeferenced map to the detailed one. To do this, move the **Import Map** tab so you can see enough of the scene to work in both windows. Next:

- In the **Import Map** tab, position the marker (📍, 🟢, 🔵) on the image being imported.
- Click the corresponding copy coordinates marker (📍, 🟢, 🔵).

- Zoom in to the point in the scene window where you wish to place the marker and click.

The coordinates in the scene will be copied to the **Import Map** tab.

Once you have set the coordinates for each marker, click **OK** to return to the main window. Once Leapfrog Geothermal saves the image, it will appear in the project tree under the **GIS Data, Maps and Photos** folder.

Automatic Georeferencing

If the image contains georeference data, it will automatically be displayed. If the georeference data in the imported image uses a different coordinate system than that used for the project, you can change the georeference data by ticking the **Override georeference data from image** box, then editing the information.

Click **OK** to import the image. It will appear in the project tree under the **GIS Data, Maps and Photos** folder.

Exporting a Georeferenced Image

Leapfrog Geothermal exports georeferenced images as GeoTIFFs. To do this, right-click on it in the project tree and select **Export**. You will be prompted for a filename and location. Click **Save**.

Setting Elevation for GIS Objects and Images

You can set the elevation for GIS objects and images by:

- Using a fixed elevation
- Using the elevation data from one of the object's attributes
- Using the elevation data from a surface in the project

The options available depend upon the type of object.

	Fixed Elevation	From Attribute	From Surface
GIS lines	X	X	X
GIS points	X	X	X
2D grids	X	-	X
GIS lines drawn in Leapfrog Geothermal	X	-	-
GIS lines extracted from polylines	X	-	X
Images	X	-	-

To set the elevation for a GIS object or an image, right-click on it in the project tree and select **Set Elevation**. The **Set Elevation** window will appear, displaying the available options. Select the option required and click **OK**.

Creating a New GIS Line

There are three ways to create a new GIS lines object in Leapfrog Geothermal:

- If you do not have GIS data for a topographical feature you wish to use in model building, you can draw a new GIS line. See [Drawing a New GIS Line](#)
- If you have two surfaces that intersect, you can generate a new GIS line from their intersection. You can use any surface in the project, including those that are generated in building models. See [Creating a New GIS Line from Intersecting Meshes](#).
- If you have a polyline you wish to use as a GIS lines object, right-click on it in the project tree and select **Extract GIS Line**. The new GIS line () will appear in the **GIS Data, Maps and Photos** folder. It is not linked to the original polyline.

To view new GIS line draped on the topography, select the object from the **GIS data > GIS objects** list, as described in [Topography Display Options](#).

Drawing a New GIS Line

GIS lines can be drawn on the slicer or on a surface.

Right-click on the **GIS Data, Maps and Photos** folder and select **New GIS Line > From New Drawing**. In the window that appears, enter a name for the new object and click **OK**.

The object will be created in the project tree and added to the shape list. The scene view will change to view the objects in the scene from above and tools for drawing polylines will appear. Click on the **Draw lines** button (🖋️) and start drawing in the scene, as described in [Drawing in the Scene](#).

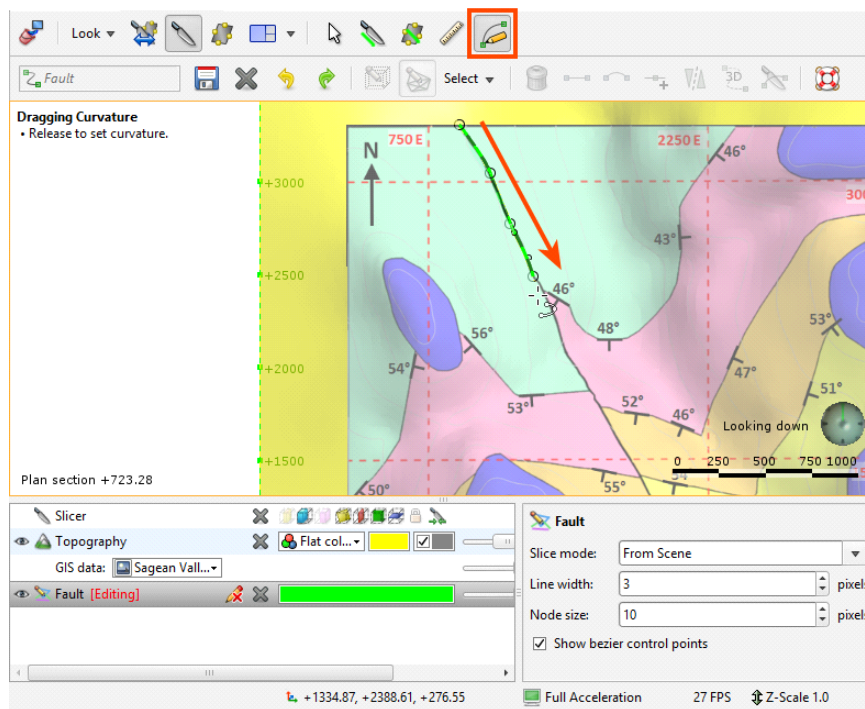

When you have finished drawing, click the **Save** button (💾). The new line (🖋️) will be saved in the project tree.

You can edit the GIS line by right-clicking on it in the project tree and selecting **Edit**. If it is in the shape list, you can edit it by clicking on the **Edit** button (🖋️).

Creating a New GIS Line from Intersecting Meshes

You can create a new GIS line from two intersecting meshes. You can use any surface in the project, including those that are generated in building models.

To create a new GIS line from two intersecting meshes, right-click on the **GIS Data, Maps and Photos** folder and select **New GIS Line > From Intersecting Meshes**. In the window that appears, select the meshes to use, enter a name for the new object and click **OK**.

The new line (🖋️) will be saved in the project tree. It is not linked to the meshes used to create it and will not be updated when the meshes are updated.

Exporting GIS Data

To export GIS data, right-click on the GIS data object in the **GIS Data, Maps and Photos** folder and select **Export**. The **Export GIS** window will be displayed:

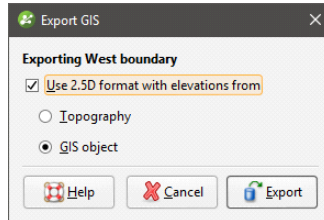

Select whether elevation information will come from the topography or from the GIS object itself, or untick the **Use 2.5D format with elevations from** box to export the object without elevation information.

Click **Export**. You be prompted for a filename and location.

Well Data

Well data forms the basis for creating models in Leapfrog Geothermal. Because well data often contains errors that reduce the reliability of a model, Leapfrog Geothermal has tools that help you to identify and correct errors and work with the data.

Well data defines the physical 3D shape of wells. It is made up of:

- A collar table, containing information on the location of the well.
- A survey table, containing information that describes the deviation of each well.
- At least one interval table, containing information on measurements such as lithology, date or any numeric or textual values. An interval table must also include collar IDs that correspond to those in the collar table and sample start and end depth.

A screens table can also be imported, if available.

When a project is first created, the only options available via the **Well Data** folder are for importing data. See [Importing Well Data](#) for more information on these options.

Once data has been added to the project, a **Wells** object will be created that serves as a container for the tables imported:

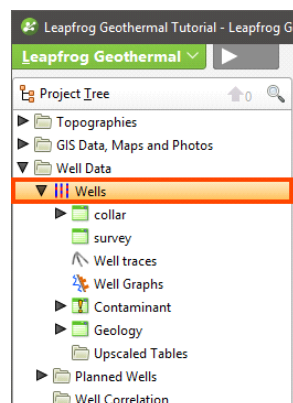

You can open each table by double-clicking on the table icon (📄). The table will be displayed and you can make changes. See [Working with Data Tables](#). When there are errors in the data, the relevant table will be marked with a red X (❌). See [Correcting Data Errors in Leapfrog Geothermal](#) for more information on fixing well data errors.

Leapfrog Geothermal also has tools for creating new lithology data columns from existing columns in order to solve problems with the well data. See [Processing Well Data](#) for more information.

To delete a lithology or numeric data table, right-click on the table in the project tree and select **Delete**. You will be asked to confirm your choice.

When you right-click on the well or collar table object in the project tree and select **Delete**, the resulting action will also remove all lithology and numeric data tables from the project. You will be asked to confirm your choice.

With Leapfrog Geothermal, you can also plan wells and evaluate them against any model in the project. See [Planning Wells](#) for more information.

The rest of this topic discusses options for displaying wells and viewing statistics on well data tables. It is divided into:

- [Displaying Wells](#)
- [Viewing Well Data Table Statistics](#)

Displaying Wells

Viewing well data in the scene is an important part of refining well data and building a geological model. Therefore, Leapfrog Geothermal has a number of different tools for displaying well data that can help in making well data processing and modelling decisions. Display well data in the scene by dragging the **Wells** object into the scene. You can also drag individual tables into the scene.

Once well data is visible in the scene, click on a well to view the data being displayed. You can also display the data associated with each interval by clicking on the **Show text** button (A) in the shape list. Here, data display is enabled for two interval tables:

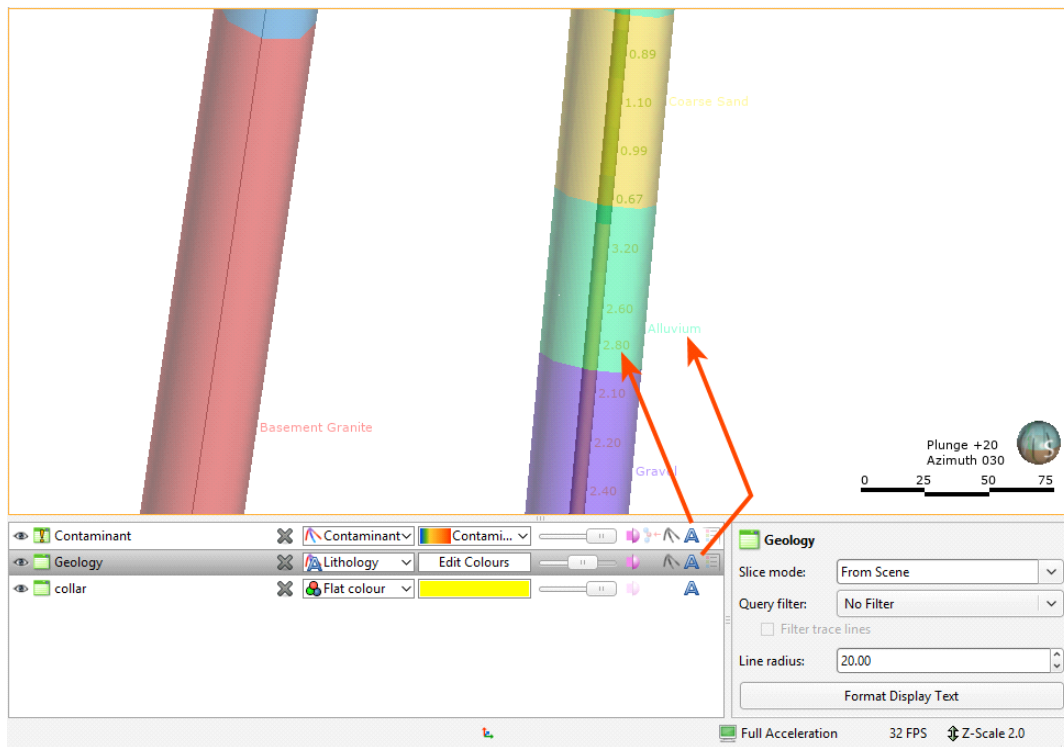

The **Show trace lines** button (A) in the shape list displays all trace lines, even if there is no data defined for some intervals. The **Filter trace lines** option in the shape properties panel displays only trace lines for wells selected by a query filter. See the [Query Filters](#) topic for more information.

Displaying Wells as Lines or Cylinders

You can display wells as lines or cylinders. You can also display the data associated with each segment. Here, the wells are displayed as flat lines:

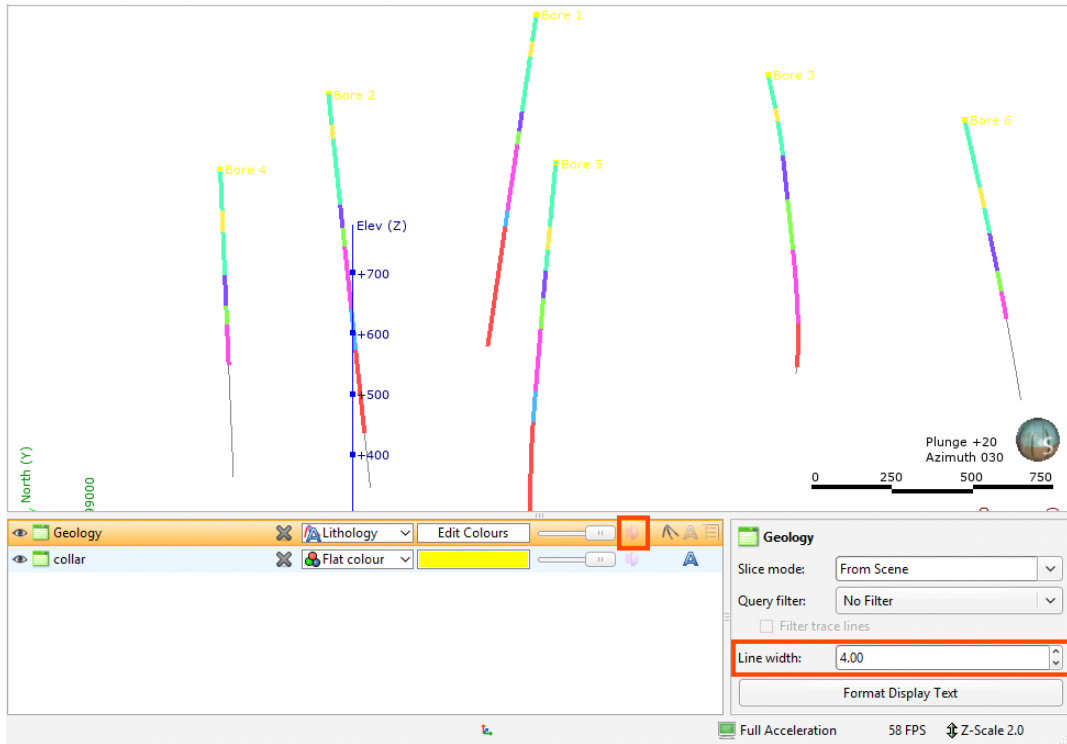

The width of the lines is set in the shape properties panel.

When the **Make lines solid** button (🔴) is enabled, the well data is displayed as cylinders and the property that can be controlled is the **Line radius**:

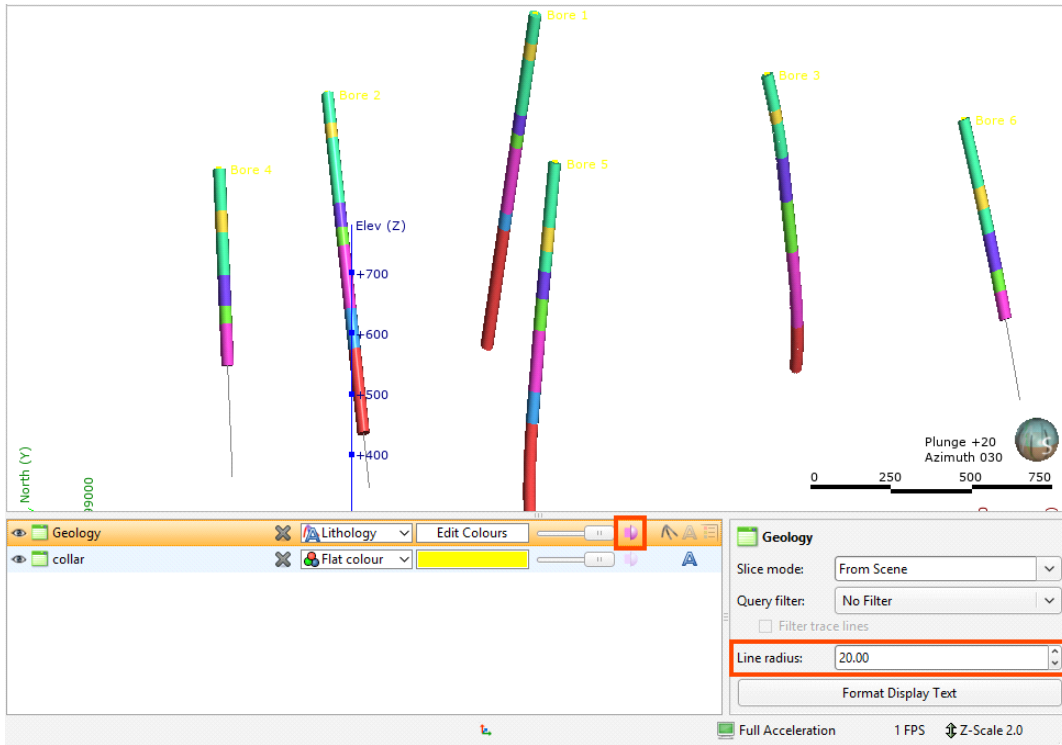

When numeric data is displayed, there is an additional option, to use a data column in the table for the cylinder radius:

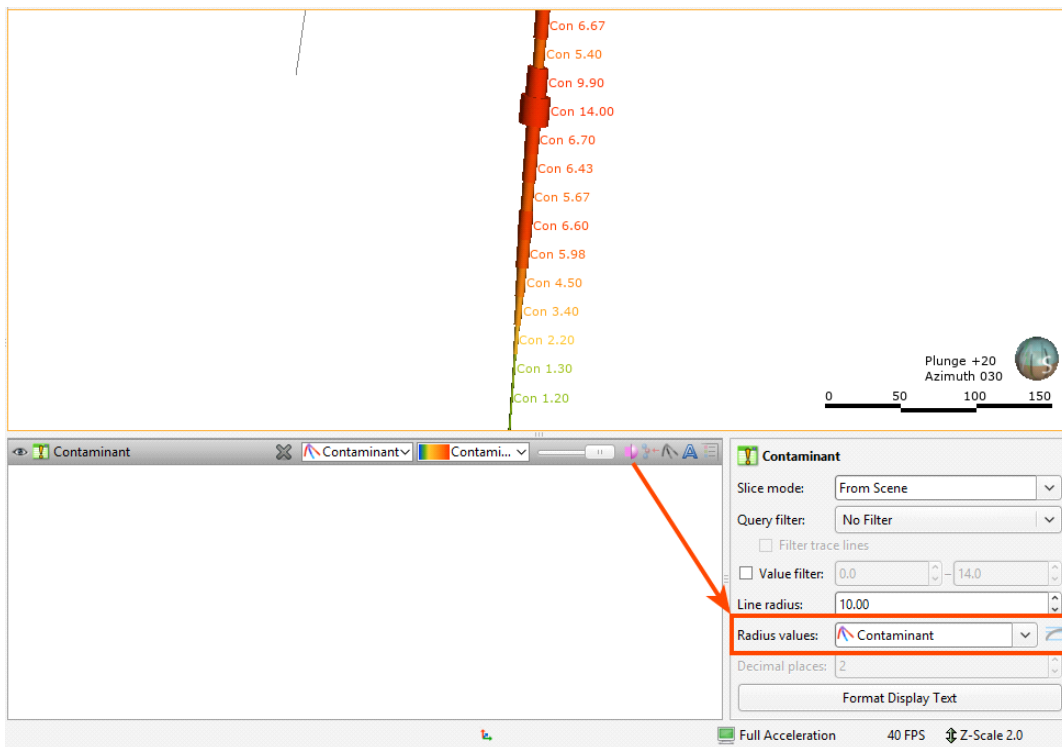

When the log button (📊) is enabled, the log of values is used for the radius.

Hiding Lithologies

When lithology tables are displayed, you can hide some of the lithologies to help make better sense of the information in the scene. Click on the **Edit Colours** button in the shape list. In the window that appears, use the **Show/Hide** buttons (👁️) to determine what segments are displayed:

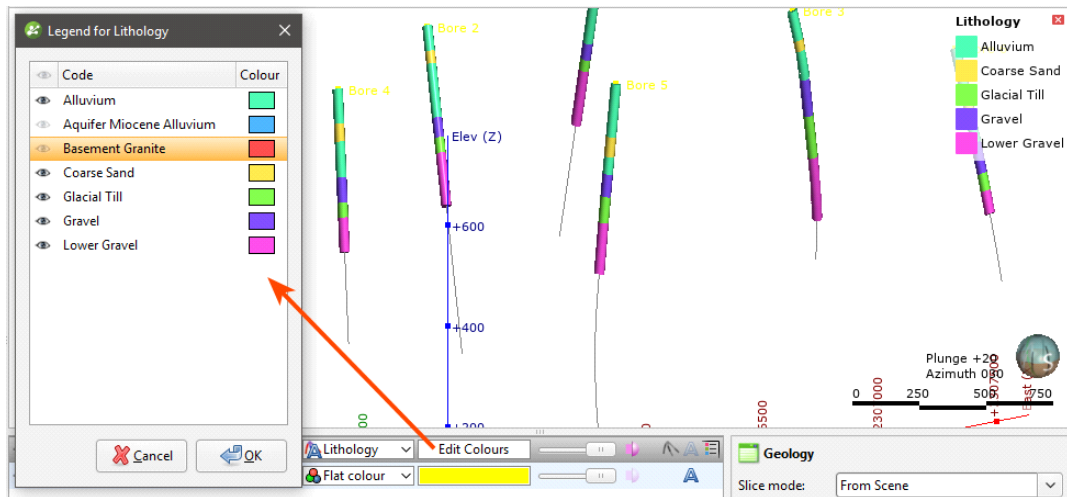

To select multiple lithologies, use the Shift or Ctrl keys while clicking. You can then change the visibility of all selected lithologies by clicking one of the visibility (👁️) buttons.

Hiding lithologies in this way only changes how the data is displayed in the scene. Another way of limiting the data displayed is to use a query filter (see the [Query Filters](#) topic), which can later be used in selecting a subset of data for further processing.

Displaying a Legend

To display a legend in the scene, click the **Show legend** button (📖) for the table:

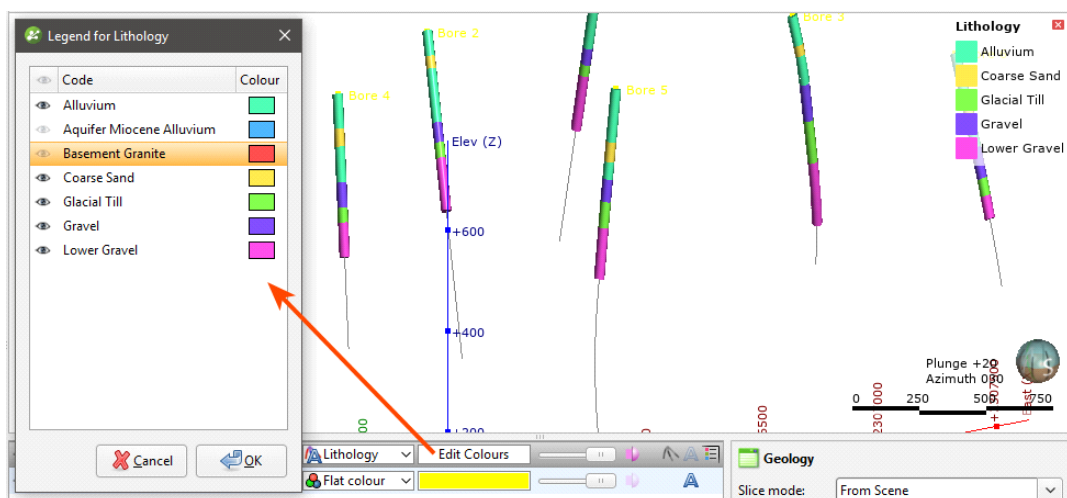

The legend in the scene will be updated to reflect lithologies that are hidden in the scene when you click **Edit Colours** and hide some lithologies.

Changing Colourmaps

To change the colours used to display lithologies, click on the **Edit Colours** button in the shape list. In the window that appears, click on the colour chip for each lithology and change it as described in [Single Colour Display](#).

To set multiple lithologies to a single colour, use the Shift or Ctrl keys to select the colour chips you wish to change, then click on one of the colour chips. The colour changes you make will be made to all selected lithologies.

You can also import a colourmap, which is described in [Colourmaps](#).

Viewing Multiple Interval Tables

When viewing multiple interval tables, use the line and point size controls and the transparency settings to see all the data at once. For example, here, the geology table has been made transparent to show the contaminant intervals inside:

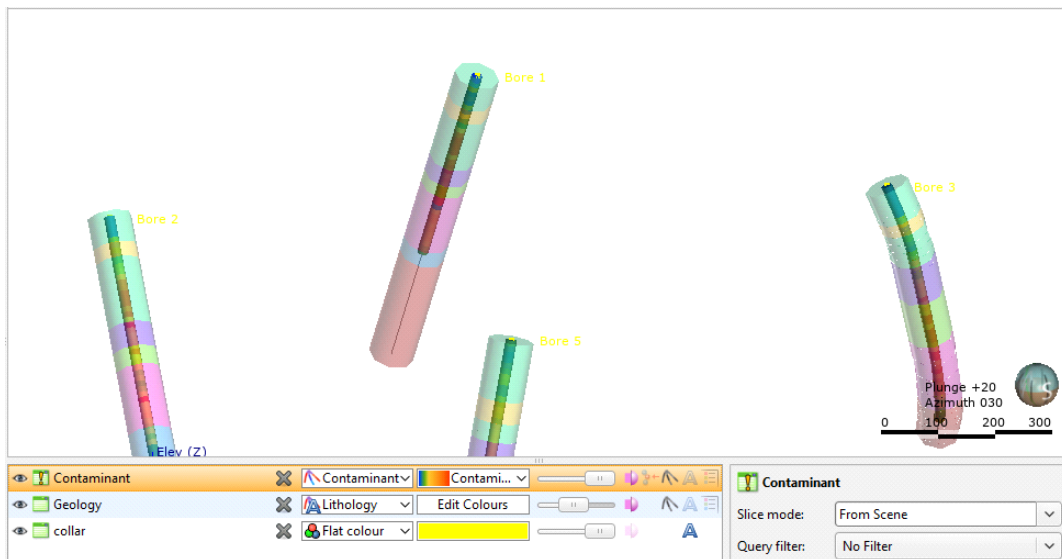

Selecting from Multiple Columns

When an interval table has more than one column of data, select the column to view from the view list:

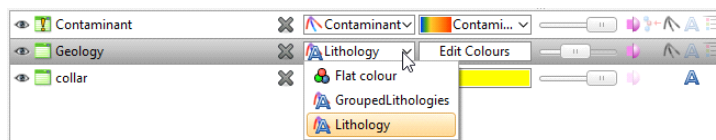

Some columns are editable, in which case you can click on the **Edit** button (✎) to start editing the table:

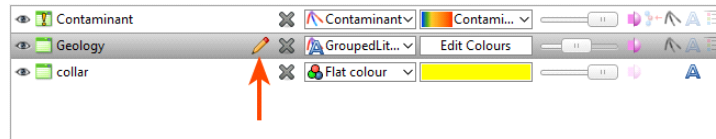

Displaying Interval Data in the Scene

Wells can be displayed with the data associated with each segment. For example, in the scene below, contaminant values are displayed along the well:

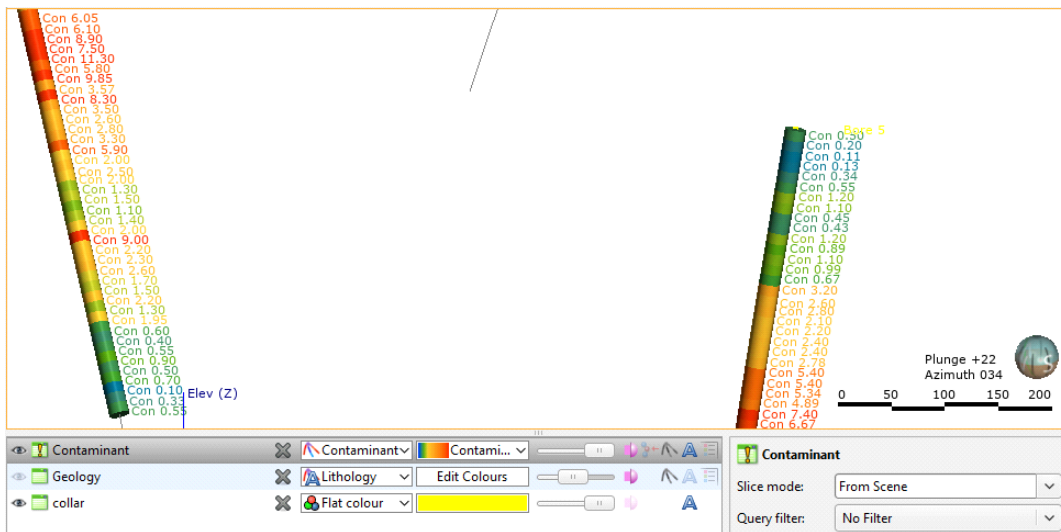

To view data in this way, select the table in the shape list, then click on the **Format Text** button. In the **Text Format** window, click **Insert Column** to choose from the columns available:



You can display multiple columns and add text:

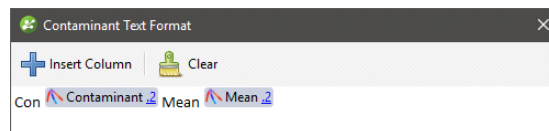

Click **OK** to update the formatting in the scene. You can conceal the formatting in the scene by clicking on the **Show text** button (A) in the shape list:

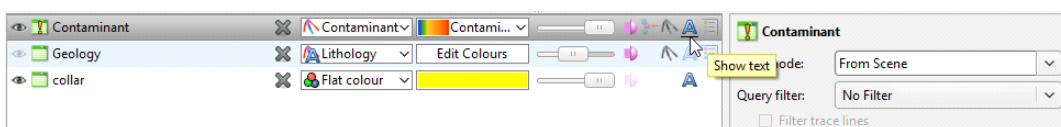

Clear text formatting by clicking on the **Format Text** button, then on **Clear**.

Displaying Well Graphs

Downhole numeric data can be displayed in the scene as a bar graph and downhole points data can be displayed as a line graph. To display downhole data in this way, add the **Well Graphs** object to the scene. The **Well Graph Style Manager** will be displayed, showing the data columns available:

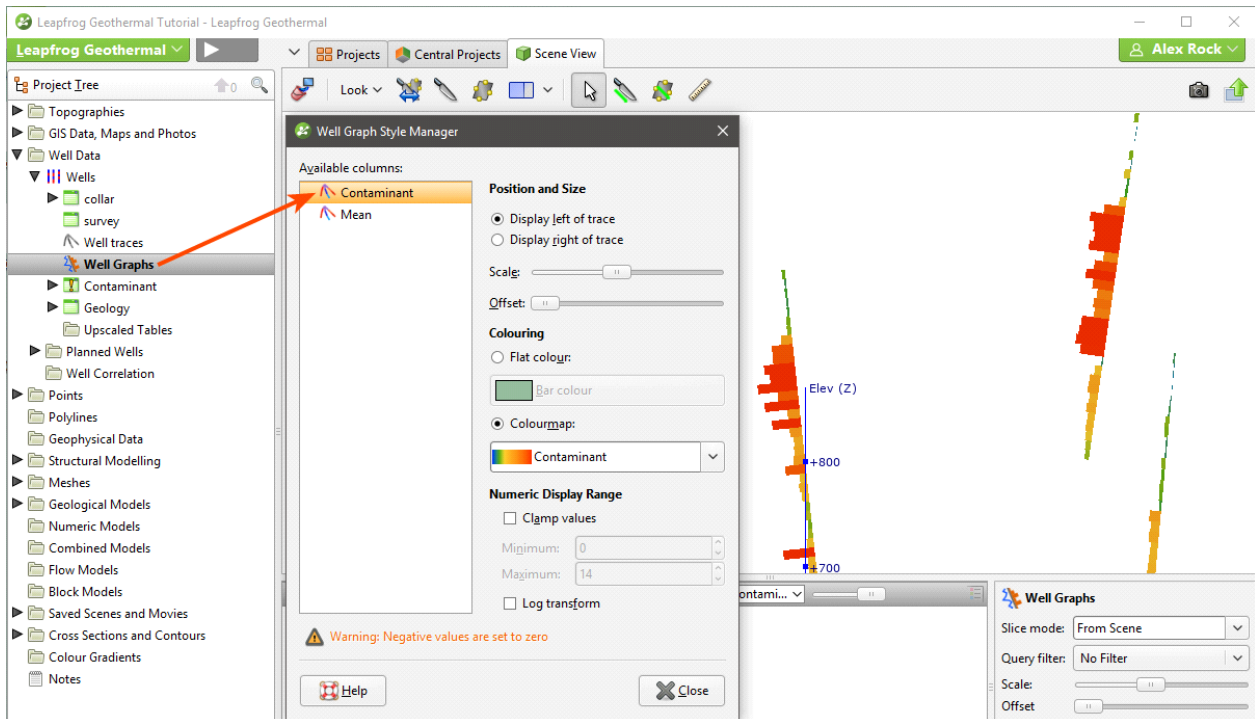

Data can be displayed to the right or the left of the well trace. Use the sliders to change the **Scale** and the **Offset** from the trace.

Data can be clamped, e.g. all values above the set maximum value will be set to the maximum value.

If there are negative values in the data, they will be displayed on the graph with a value of zero.

Downhole points can be displayed as a line, and you can change the **Colouring**, **Scale** and **Offset** of the line:

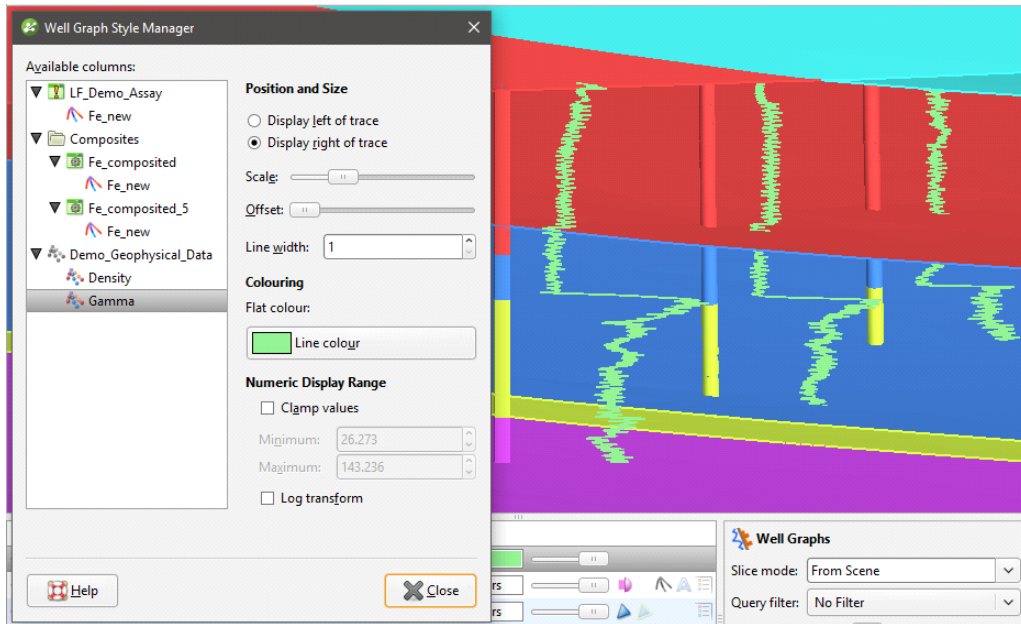

All changes made in the **Well Graph Style Manager** are automatically updated in the scene so you can experiment with the settings. Once you have closed the window, you can also change the **Scale** and **Offset** by clicking on the **Well Graphs** object in the shape list:

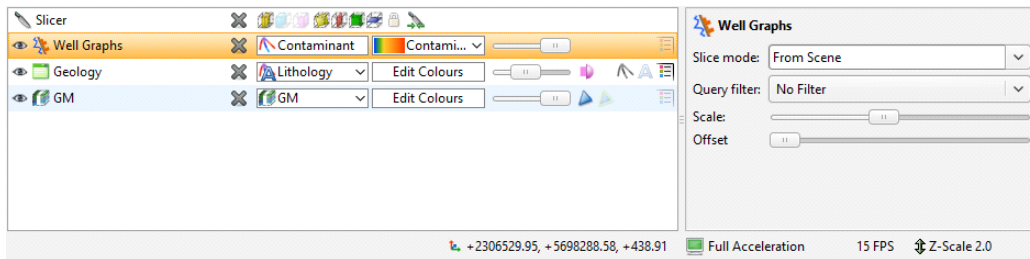

To select a different column to display, open the style manager by double-clicking on the **Well Graphs** object in the project tree or select a new column from the shape list.

If you are working in a new project into which you have just imported wells, the **Well Graph Style Manager** will open when you add it to the scene. If the **Well Graph Style Manager** does not open when you add the **Well Graphs** object to the scene, it is because the styles have already been set, perhaps by another user. You can change them by double-clicking on the **Well Graphs** object.

Viewing Well Data Table Statistics

To view statistics on an interval table, right-click on the table in the project tree and select **Statistics**. The following options are available:

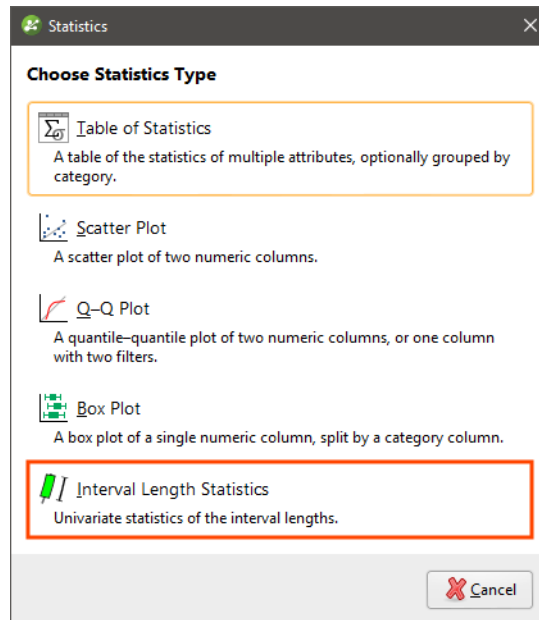

See the [Analysing Data](#) topic for more information on each option:

- [Table of Statistics](#)
- [Scatter Plots](#)
- [Q-Q Plots](#)
- [Box Plots](#)

The **Interval Length Statistics** graph is a univariate graph, so for more information on the options available, see [Univariate Graphs](#) in the [Analysing Data](#) topic.

Right-click on a numeric column and select **Statistics** to open a univariate graph for that column.

Importing Well Data

Well data can be imported from:

- Files stored on your computer or a network location. This process is described below.
- From any database that runs an ODBC interface. See [Selecting the ODBC Data Source](#).
- From an acQuire database. See [Connecting to an acQuire Database](#).

For each of these options, once the data source is selected, the process of importing well data is the same.

The rest of this topic discusses the data format required and the steps for importing well data. It is divided into:

- [Expected Well Data Tables and Columns](#)
- [Selecting Files](#)
- [Working Through the Data](#)

Expected Well Data Tables and Columns

Leapfrog Geothermal expects well data that is stored in a collar table, a survey table and at least one interval table. A screens table can also be imported.

The following formats are supported:

- CSV Text File (*.csv)
- ASCII Text File (*.asc)
- Plain Text Files (*.txt)
- Data Files (*.dat)
- TSV Text Files (*.tsv)

The Collar Table

The collar table should contain five columns:

- A well identifier
- The location of the well in X, Y and Z coordinates
- The maximum depth of the well

A collar table can also contain a trench column, and collars marked as trenches will be desurveyed in a manner different from other wells. See [Well Desurveying Options](#) for more information.

Leapfrog Geothermal expects a 0 for a normal hole and a 1 for a trench. If there is no trench column in the collar table, Leapfrog Geothermal will create one.

The well ID is used to associate data in different tables with a single well. The ID for a well must be identical in all tables in order for data to be associated with that well. Inconsistencies in the way wells are identified are common sources of errors.

The maximum depth column is optional. If it is present, is used to validate the data imported for the interval tables. The maximum depth specified is often a planned quantity, whereas the interval table records actual measurements. For this reason, Leapfrog Geothermal has an option for fixing the maximum depth value in the collar table to match the data in an interval table.

If maximum depth information is not included in a collar file, Leapfrog Geothermal will determine it from the maximum depth sampled as indicated by data in the interval tables.

The Survey Table

For the survey table, Leapfrog Geothermal expects a well identifier and depth, dip/inclination and azimuth values. You cannot have both an inclination column and a dip column so if a table contains both columns, you will need to choose between the two. When you import an inclination column, the survey table in the project tree will include a dip column, calculated from the inclination values.

By default, Leapfrog Geothermal assumes that negative dip values point up. If this is not the case, tick the **Negative survey dip points down** option.

See [Well Desurveying Options](#) for more information on the well desurveying algorithms used in Leapfrog Geothermal.

The Screens Table

For the screens table, Leapfrog Geothermal expects a minimum of four columns:

- A well identifier
- Start/from and end/to depths
- A value column

Interval Tables

For interval tables, Leapfrog Geothermal expects, at minimum, four columns:

- A well identifier
- Start/from and end/to depths
- A column of measurements

If a well ID in an interval table does not correspond to one in the collar table, the table can still be imported but the interval table will contain errors.

Supported column types are:

- Lithology columns containing lithologic data, which can be used for geological modelling.
- Numeric columns containing numeric values, which can be used for interpolating data.
- Category columns, which is text representing categories such as company, geologist, or mineralisation.
- Text columns containing text data that is not categorical, such as comments. Text columns are not validated when imported.
- Date columns containing date data. Custom date and timestamps formats are supported.
- URL columns. Use the prefix file:/// to link to local files.

When an interval table is displayed in the scene and an interval is selected, clicking on a link in the URL column will open the link. This is a useful way of linking to, for example, data files or core photo images from within Leapfrog Geothermal:

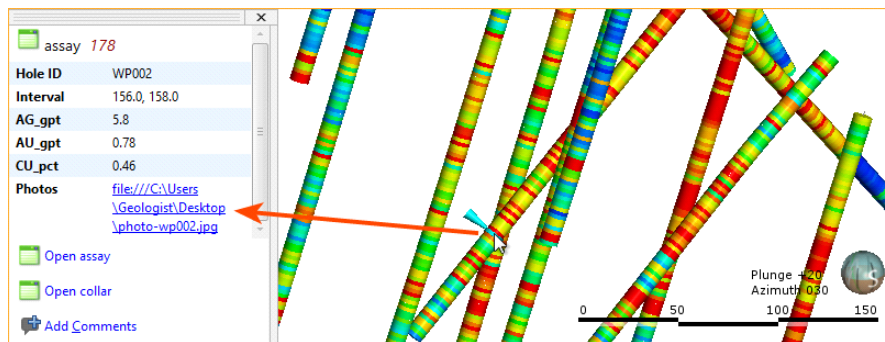

Selecting Files

To import well data, right-click on the **Well Data** folder and select **Import Wells**. The **Import Well Data** window will appear:

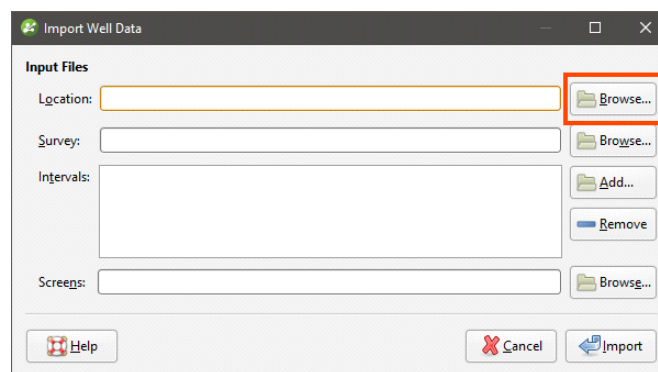

For the **Collar**, click on the **Browse** button to locate the collar file.

When a collar file is added to the **Import Well Data** window, Leapfrog Geothermal will look for interval tables with names such as "lithology" or "geology" in the same location and will add them to the **Interval Tables** list. If an interval table file is not automatically added to the list, click **Add** and browse for the required file.

You can also add any screens to import by clicking on the **Screens – Browse** button.

In the screen below, a collar file, a survey file and two interval tables have been selected for import:

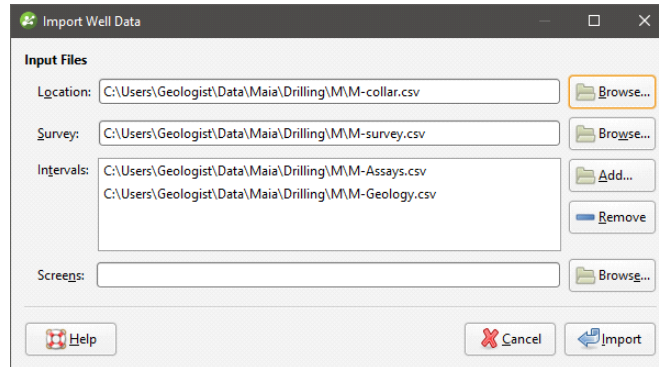

Working Through the Data

Clicking on **Import** starts the process of importing data, which involves matching the data in the selected files with the columns Leapfrog Geothermal expects for each type of table. Leapfrog Geothermal will display a series of windows and will attempt to match the data in the files with the columns expected, based on the header rows in each file.

Progress in working through the data is shown at the top of the window:

	Well ID	Not Imported	Not Imported	East (X)	North (Y)	Elev (Z)
1	HoleID	East_UTM	North_UTM	Local_East	Local_North	Elev
2	M001	543999.23	4317499.06	13999.23	517499.06	727.169
3	M002	544050.38	4317500.76	14050.38	517500.76	726.926
4	M003	544098.9	4317500.57	14098.9	517500.57	727.68
5	M004	544149.06	4317501.1	14149.06	517501.1	728.876

The file currently displayed is shown in bold.

For *.csv files that use characters other than the comma as the separator, you can specify the delimiter, comment leader, quote and decimal characters in the **Import Well Data** window. Click on **CSV characters** to enter the characters used in the data files:

The row at the top of the table indicates the data type to which Leapfrog Geothermal will assign each column:

	Well ID	Not Imported	Not Imported	East (X)	North (Y)	Elev (Z)
1	HoleID	East_UTM	North_UTM	Local_East	Local_North	Elev
2	M001	543999.23	4317499.06	13999.23	517499.06	727.169
3	M002	544050.38	4317500.76	14050.38	517500.76	726.926
4	M003	544098.9	4317500.57	14098.9	517500.57	727.68
5	M004	544149.06	4317501.1	14149.06	517501.1	728.876

Click at the top of a column to view the column assignments available. The columns highlighted below are the column types required for the collar table:

	Well ID	Not Imported	Not Imported	East (X)	North (Y)	Elev (Z)
1	"HoleID_1" Category		North_UTM	Local_East	Local_North	Elev
2	"HoleID_1" Text		4317499.06	13999.23	517499.06	727.169
3	"HoleID_1" Numeric		4317500.76	14050.38	517500.76	726.926
4	"HoleID_1" Time Stamp		4317500.57	14098.9	517500.57	727.68
5	"HoleID_1" Date		4317501.1	14149.06	517501.1	728.876
6	"HoleID_1" URL		4317499.88	14199.59	517499.88	727.68
7	Not Imported		4317099.26	14250.21	517099.26	727.68
8	Well ID		4317149.8	14249.95	517149.8	727.68
9	East (X)		4317200.87	14250.86	517200.87	727.68
10	North (Y)		4317250.97	14250.02	517250.97	727.68
11	Elev (Z)		4317099.17	14500.73	517099.17	727.68
12	Max Depth		4317149.71	14500.94	517149.71	727.68
13	Custom Name...		4317200.42	14500.74	517200.42	727.68
14	...		4317249.34	14500.39	517249.34	727.68

Each type of table being imported will have different column assignments available, but all table types will display:

- The categories columns can be assigned to (top of the list)
- The option to not import the column
- The required columns, e.g. well Id, East (X), North (Y) and Elev (Z) for the collar table
- Any optional columns, e.g. Max Depth and Trench
- The option to select a custom name

If the header row for a column cannot be matched, Leapfrog Geothermal will mark the column as "Not Imported" and you can select from the column assignments available. If you choose not to import a column then wish to do so later, you can add it later using the **Import Column** option. See [Importing Columns](#).

You can also work with the **Column Summary**:

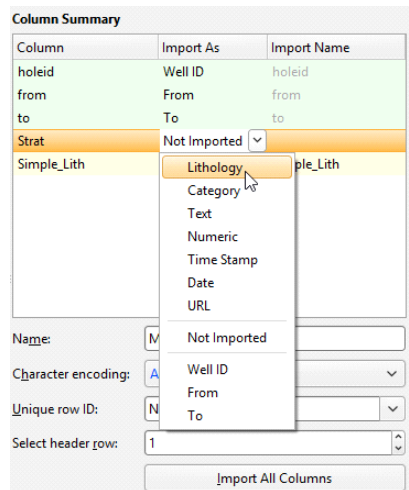

If you wish to import all columns, click on the **Import All Columns** button, then check that all columns have been correctly mapped.

You can select a column for import, then use it as a **Unique Row ID**. This can specify the column being used in other data systems to uniquely identify rows in a table. The column must not contain duplicate values. If a **Unique Row ID** is specified, Leapfrog Geothermal will use this column to match rows when appending columns or reloading tables.

If the data contains date and time information and the date and time format is not detected, click on **Date and Time Formats** to reveal more information:

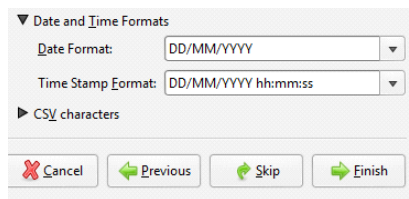

If the date and time format you wish to use is not among the options, you can create a custom format.

For each file, check the column mapping and click **Next** to proceed to the next step. If any of the information Leapfrog Geothermal expects is missing, an error message will appear. Return to the table and correct the problem described.

Once you have checked the last file, click on **Finish**. Once Leapfrog Geothermal has imported the data, it will appear in the project tree under a new **Wells** object.

Selecting the ODBC Data Source

To import well data directly from any database that uses an ODBC interface, right-click on the **Well Data** folder and select **Import Well Data via ODBC**. The **Select ODBC Data Source** window will appear:

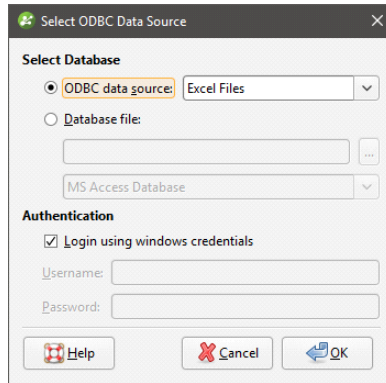

Leapfrog Geothermal supports database files in Access Database (*.mdb, *.accdb) formats. Enter the information supplied by your database administrator and click **OK**.

Selecting Tables

Leapfrog Geothermal will select the collar, survey and interval tables from the data in the file, which is displayed in the **Select Tables To Import** window:

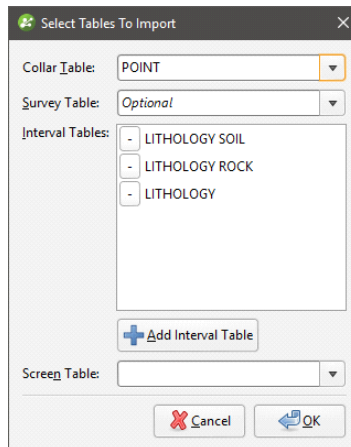

Click on the **Collar Table**, **Survey Table** and **Screen Table** dropdown lists to select from the data available in the file.

To change one of the **Interval Tables** to a different column in the file, click on the table name to highlight it, then click to the right of the column name to activate the dropdown list:

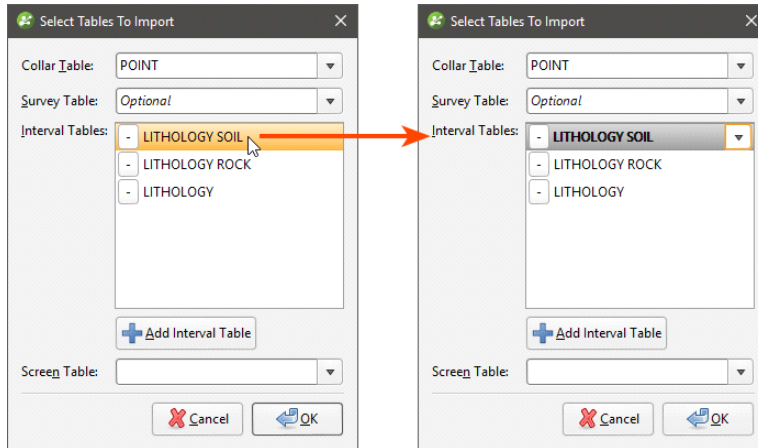

To remove an interval table from the list, click the - button.

To add an interval table, click the **Add Interval Table** button. A - button will be added to the **Interval Tables** list.

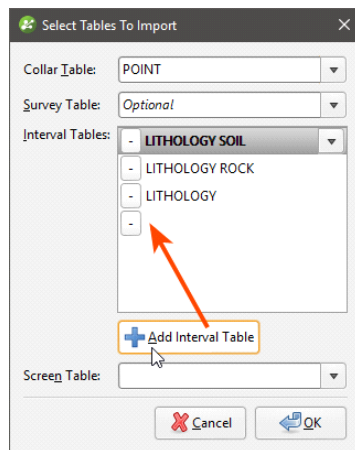

Click on the blank space to highlight it, then click to the right of the column name to activate the dropdown list:

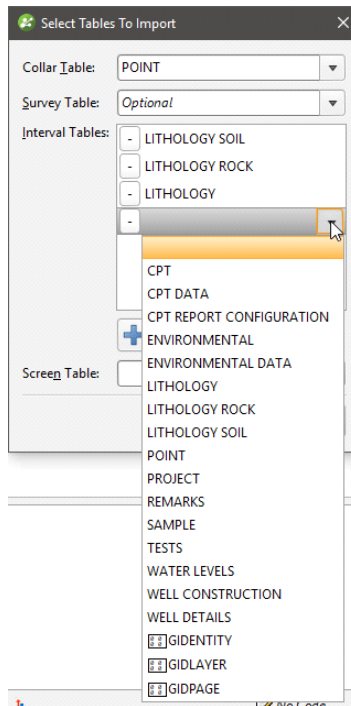

Click **OK** to begin the process of importing the data, which is similar to that described in [Importing Well Data](#).

Connecting to an acQuire Database

There are two options for connecting to an acQuire database:

- Create a new connection. To do this, right-click on the **Well Data** folder and select **Import Well Data via acQuire > New Selection**. Select the server and click **Connect**. Next, enter the login details supplied by your database administrator.
- Create a connection from an existing selection file. Right-click on the **Well Data** folder and select **Import Well Data via acQuire > Existing Selection**. Navigate to the location where the selection file is stored and open the file.

Once connected to the database, you will be able to select the required data using the **Select data from acQuire** window.

Optionally, click the **Profiles** button and choose a profile from those on the acQuire database. Profiles are created in acQuire; see your acQuire administrator for more information.

You can also use the other tabs on the acQuire component interface to make other data selections.

For more information on using the third-party selection tools provided in the **Select data from acQuire** window, see your acQuire user documentation. When you have finished specifying the selection, click **OK** to import the data. The import process is similar to that described in [Importing Well Data](#).

Once the well data has been loaded, you can:

- Import additional interval tables. See [Importing Interval Tables](#).
- Update the well data with new data from the acquire database. See [Smart Refresh](#).
- Reload well data. See [Reloading Well Data](#).

Smart Refresh

Smart Refresh obtains the latest well data from the acquire database without reloading the entire contents of the database. This reduces the amount of data transfer required and speeds data updated. If any data relating to a well has changed, the whole well is updated. Any new wells in the database can be added.

Right-click on the **Wells** object in the project tree and select **Smart Refresh**. The **Select data from acquire** window will appear.

If the current data selection settings include data changes, you can click **OK** and the updated data will be imported. You may also chose to modify the data selection settings, which may append further data when you click **OK**.

Saving a Selection

Saving a selection saves the current acquire database selection to file for future reuse. You can use a selection to import the same set of well data in new Leapfrog Geothermal projects.

To save an acquire selection, right-click on the **Wells** object in the project tree and select **Save Selection**. You will be prompted for a filename and location.

Appending Wells

If well data is stored in multiple files or new well data is available, you can import other files into the project and add them to the existing well data. To do this, right-click on the **Wells** object and select **Append Wells**.

Append well data when you have new wells or wish to add extra length to existing wells. If you wish to refresh well data, overwriting all existing well data, use the **Reload Wells** option.

The **Append Wells** window will be displayed. Appending well data is similar to importing the original data (see [Importing Well Data](#)):

- If the well data was loaded from a file on your computer or a network location, you will be asked to specify the file locations. Step through the files, checking the **Column Summary** for each file to ensure that the correct information will be imported, then click **Finish** to add the new files.
- If the interval table is stored in an ODBC database, you will be prompted to connect to the database. See [Selecting the ODBC Data Source](#).
- If your well data is stored in an acquire database, you will be prompted to connect to the database. See [Connecting to an acquire Database](#).

Importing Interval Tables

Interval tables that have not been imported during the well data import process can be added to the project at any time. To add an interval table, right-click on the **Wells** object in the project tree and select from the options available:

- If the interval table is stored in a file on your computer or a network location, select **Import From File > Interval Values**. Leapfrog Geothermal will ask you to specify the file location, and then will display the data in the file in the **Import Interval** window.
- If the interval table is stored in an ODBC database, select **Import From ODBC > Interval Values**. You will be prompted to select the data source. See [Selecting the ODBC Data Source](#).
- If your well data is stored in an acQuire database, select **Import From acQuire > Interval Values**. See [Connecting to an acQuire Database](#).

Columns required are:

- A well identifier
- Start/from and end/to depths
- A column of measurements

See [Expected Well Data Tables and Columns](#) for more information on the supported column types.

Select the required columns and assign the data type for each column. Click **Finish** to import the file, which will appear under the **Wells** object.

Importing Columns

Columns of an interval table that have not been imported during the well data import or that are stored in a separate file can be added to the table at any time. To do this, right-click on the interval table in the project tree and select **New Column > Import Column**.

Importing a column is similar to importing interval tables themselves. Leapfrog Geothermal will ask you to specify the file location, and then will display the data in the file in the **Add Column To Table** window. Select as many columns to import as required and assign the appropriate data type. Before finishing, check the **Column Summary** to ensure that the correct information will be imported.

It is not necessary to re-import any columns that are already part of the project. The well ID and To and From data columns, however, will be used to check the validity of the new column against existing data. Any rows that do not match will not be imported.

Click **Finish** to import the new column.

Importing Screens

Screens that have not been imported during the well data import process can be added to the project at any time. To do this, right-click on the **Wells** object in the project tree and select

Import From File > Screens or **Import From ODBC > Screens**.

When importing from a file, Leapfrog Geothermal will ask you to specify the file location, and then will display the data in the file in the **Import Screen** window.

When importing from ODBC, you will first be prompted to select the data source. See [Selecting the ODBC Data Source](#).

Columns required are:

- A well identifier
- Start/from and end/to depths
- A value column

Select the required columns and assign the data type for each column. Click **Finish** to import the file, which will appear under the **Wells** object.

A Leapfrog Geothermal project can have only one screens table.

Importing Point Values Down Wells

To import a set of points on wells, right-click on the **Wells** object in the project tree and select **Import From File > Point Values** or **Import From ODBC > Point Values**.

When importing from a file, Leapfrog Geothermal will ask you to specify the file location and then will display the data in the file in the **Import Depth Points** window.

When importing from ODBC, you will first be prompted to select the data source. See [Selecting the ODBC Data Source](#).

Columns required are:

- A well identifier
- Depth

Select the required columns and assign the data type for each column. Click **Finish** to import the file, which will appear under the **Wells** object.

Importing LAS Points Down Wells

Leapfrog Geothermal imports LAS points down wells in LAS 1.2 and LAS 2.0 formats. An imported set of LAS files appears as one object with its associated data columns plus a **LAS Wells** folder that contains a filter for each well. Importing the data preserves the metadata from the LAS files, which can be viewed in the **Properties** window for the LAS points object and in the **Properties** window for each well.

To import LAS points down wells, right-click on the **Wells** object and select **Import From File > LAS Data**. Select the files you wish to import and click **Open**.

Next, the **Import LAS Data** window will appear. The data displayed in this window is combined from the selected files, with blank and invalid values indicated by "nan". For example, if a well file does not contain columns that are included in other well files, those missing columns will be marked as "nan".

Leapfrog Geothermal expects well ID and Depth columns and will attempt to match the data in the files with the expected format. Select the columns to import, then click **Finish**. The files will be added to the project tree as part of the **Wells** object, as described above.

To view LAS points, add the LAS points object (📁) to the scene. You can also display individual wells by adding their filters to the scene.

LAS File Mapping

The **Properties** window for **LAS Wells** includes a **LAS Mapping** tab that shows what data files have been used for the selected well:

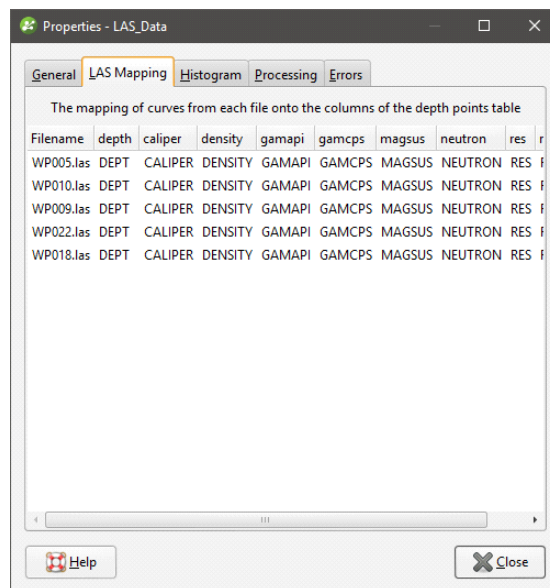

This is useful when data for a well originates in different files.

LAS File Inconsistencies

When importing LAS files, inconsistencies in the files are handled as follows:

- If there are two files with the same curve values at the same depth, the duplicate values will be added to the existing column and flagged as overlapping segments. See [Correcting Data Errors in Leapfrog Geothermal](#) for more information about correcting well data errors.
- If there are more than two files with the same curve values at the same depth, Leapfrog Geothermal will not be able to import the files. Note the conflicting files shown in the error message and reimport the files, leaving the conflicting files out.
- If there are multiple logs of the same name in the files, Leapfrog Geothermal will not be able to import the data. Edit the LAS file header outside of Leapfrog Geothermal to change the names.

Importing Downhole Structural Data

Leapfrog Geothermal supports structural measurements in .csv or text formats. This topic describes importing downhole structural data tables. Structural data tables that include

location information can also be imported to the **Structural Modelling** folder. See [Importing Planar Structural Data](#).

To import a set of structural data on wells, right-click on the **Wells** object in the project tree and select **Import From File > Planar Structural Data** or **Import From ODBC > Planar Structural Data**.

When importing from a file, Leapfrog Geothermal will ask you to specify the file location and then will display the data in the file in the **Import Planar Structural Data** window.

When importing from ODBC, you will first be prompted to select the data source. See [Selecting the ODBC Data Source](#).

Leapfrog Geothermal expects columns describing the well identifier, the depth and the structural orientation. Structural orientation can be specified using either dip and dip azimuth or alpha and beta.

Match the values in the file to the required column headers, then click **Finish** to import the file. The table will appear under the **Wells** object.

If the structural orientation is specified using alpha and beta, the reference line from which the beta is measured can be the bottom or top of the well. When the table is imported, the default setting is **Bottom of core**. To change this, double-click on the structural data table in the project tree. Next, click on **Compatibility** to change the **Beta reference mark** setting to **Top of core**:

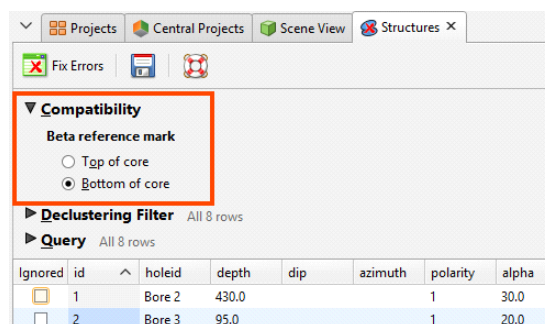

Well Desurveying Options

Well desurveying computes the geometry of a well in three-dimensional space based on the data contained in the survey table. Under ideal conditions, the well path follows the original dip and azimuth established at the top of the well. Usually, though, the path deflects away from the original direction as a result of layering in the rock, variation in the hardness of the layers and the angle of the drill bit relative to those layers. The drill bit will be able to penetrate softer layers more easily than harder layers, resulting in a preferential direction of drill bit deviation.

There are a number of paths a well could take through available survey measurements, but the physical constraints imposed by drilling are more likely to produce smoother paths. Selecting the desurveying method that gives the best likely approximation of the actual path of the well will ensure that subsequent modelling is as accurate as possible.

Leapfrog Geothermal implements three algorithms for desurveying wells:

- [The Spherical Arc Approximation Algorithm](#)
- [The Raw Tangent Algorithm](#)

- [The Balanced Tangent Algorithm](#)

These options are described in more detail below.

Another factor that affects how wells are desurveyed is how dip values are handled. When the survey table is imported, Leapfrog Geothermal sets the **Negative survey dip points down** value according to the data in the imported table. When the majority of the dip data in the table is positive, Leapfrog Geothermal assumes all these wells will point down and leaves the field **Negative survey dip points down** disabled. When most of the values are negative, the field is enabled. This field can be changed by double-clicking on the survey table to open it and then clicking on **Compatibility** to show the table's desurveying settings:

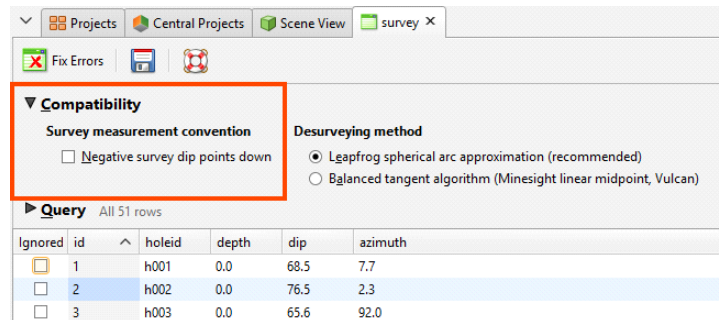

If you are going to change the automatically set value of **Negative survey dip points down**, consider carefully the implications if there is a mix of wells pointing down and up.

The other **Compatibility** setting relates to the algorithm used in desurveying the wells.

The Spherical Arc Approximation Algorithm

The default algorithm used in Leapfrog Geothermal is spherical arc approximation, which is sometimes referred to as the minimum curvature algorithm. Downhole distances are desurveyed exactly as distances along a circular arc:

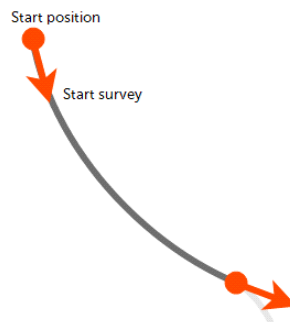

The algorithm matches the survey at the starting and end positions exactly and the curvature is constant between these two measurements. At the survey points, the direction remains continuous and, therefore, there are no unrealistic sharp changes in direction.

If you wish to use spherical arc approximation, there is no need to change any settings.

The Balanced Tangent Algorithm

The balanced tangent algorithm uses straight lines but attempts to improve the accuracy of the raw tangent algorithm by assigning equal weights to the starting and end survey measurements:

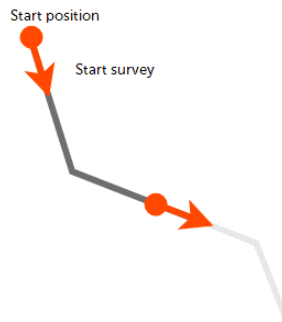

It is an improvement on the raw tangent algorithm but still suffers from an unrealistic discontinuity in the well path. It is, however, a better approximation of the overall well path and is reasonably accurate when the spacing between measurements is small.

To use the balanced tangent algorithm, double-click on the survey table in the project tree. Click on **Compatibility** and change the **Desurveying method**.

The Raw Tangent Algorithm

The raw tangent algorithm assumes the well maintains the direction given by the last survey measurement until the next new measurement is reached:

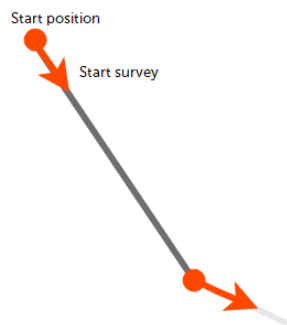

This implies that the well makes sharp jumps in direction whenever a measurement is taken, which is unlikely, except when the well is being used to define a trench.

Collar tables have a **trench** column that indicates whether or not the well is from a trench. When the **trench** column is ticked for a well, the trench will be desurveyed using the raw tangent algorithm. Double-click on the collar table in the project tree, then tick the **trench** box for the wells you wish to desurvey using the raw tangent algorithm.

Processing Well Data

Once imported and corrected, well data usually requires further processing before any models are built. Use the techniques described in [Displaying Wells](#) and [Well Correlation Tool](#) to aid in making decisions on what further processing is required.

Often, selecting a small portion of intervals can be achieved using a query filter (see the [Query Filters](#) topic). In some cases, however, you may wish to composite data to focus on a single unit. There may also be issues with how well data has been recorded; for example, two units have been catalogued as one, or a single unit may be divided into multiple units.

Leapfrog Geothermal has a number of tools for processing well data, including:

- **[Category Composites](#)**. Sometimes unit boundaries are poorly defined, with fragments of other lithologies within the lithology of interest. This can result in very small segments near the edges of the lithology of interest. Modelling the fine detail is not always necessary, and so compositing can be used to smooth these boundaries.
- **[Majority Composites](#)**. Category data can be composited into interval lengths from another table or into fixed interval lengths. The compositing is based on a majority percentage where each interval is assigned a category based on the category that makes up the highest percentage of the new interval.
- **[Numeric Composites](#)**. Compositing numeric data takes unevenly-spaced well data and turns it into regularly-spaced data, which is then interpolated. Numeric data can be composited along the entire well or in selected regions. You can also set the compositing length from the base interval table.
- **[Numeric Point Upscaling](#)**. Upscaling numeric point data works with downhole points and LAS points.
- **[Grouping Lithologies](#)**. The group lithologies tool lets you define a new unit to which existing units are added. For example, a sandstone deposit might appear in an interval table as poorly-sorted and well-sorted units. The group lithologies tool lets you group both units into a single sandstone unit.
- **[Splitting Lithologies](#)**. Lithology units may be incorrectly grouped, which can become apparent when you display wells in the scene. The split lithologies tool lets you create new units by selecting from intervals displayed in the scene.
- **[Interval Selection](#)**. If the lithologies in a column are poorly sorted, you can display the column in the scene and use the interval selection tool to work with all the segments and sort them into new units.
- **[Overlaid Lithology Column](#)**. You may have two versions of an interval column, one that contains draft data and one that contains the final version. The final version may contain gaps, which can be filled in using the draft version. The overlaid lithology tool lets you combine the two columns to create a new column.
- **[Category Column from Numeric Data](#)**. When you have numeric data you wish to use with the lithology and category modelling tools, you can convert the numeric data to a category column.

- [Back-Flagging Well Data](#). Evaluating geological models on wells creates a new lithology table containing the lithologies from the selected model.

Each of these tools creates a new interval table or creates a new column in an existing interval table, preserving the original data. New tables and columns can be used as the basis for new models in the project and can be incorporated into existing models using **From Other Contacts** options. When a new table is created, you can view it in the scene along with the original table to see the differences between the processed and the unprocessed data.

If you are working with columns in different interval tables, you can create a new merged table that includes columns from these different tables. Columns created in Leapfrog Geothermal can be included in a merged table. See [Merged Well Data Tables](#).

Category Composites

Sometimes unit boundaries are poorly defined, with fragments of other lithologies within the lithology of interest. This can result in very small segments near the edges of the lithology of interest. Modelling the fine detail is not always necessary, and so compositing can be used to smooth these boundaries.

In Leapfrog Geothermal, you can composite category data in two ways:

- Composite the well data directly. This creates a new interval table that can be used to build models, and changes made to the table will be reflected in all models based on that table. This process is described below.
- Composite the points used to create an object.

The rest of this topic describes compositing well data directly.

Right-click on the **Composites** folder, which is in the project tree as part of the **Wells** object, and select **New Category Composite**. You will be prompted to select from the category columns available in the well data. Next, the **New Composited Table** window will appear, showing the options for sorting intervals in the selected column:

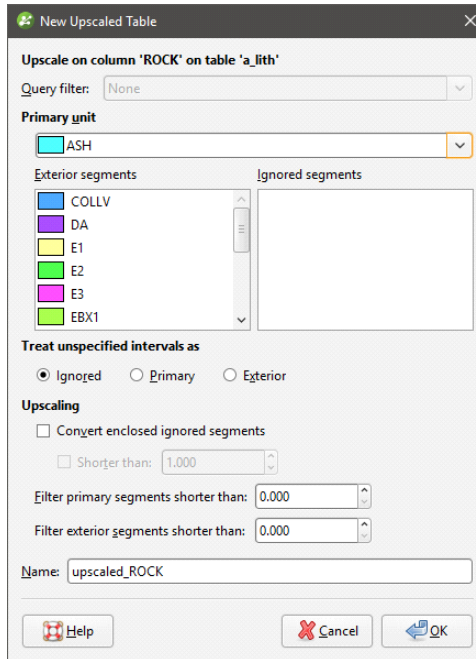

Compositing category data sorts segments into three categories:

- **Primary**. This is the unit of interest. In the case of compositing on intrusion contact surfaces, this will be the interior/intrusive lithology.
- **Ignored**. These are units that are, generally, younger than the unit of interest and should, therefore, be ignored in generating contact surfaces.
- **Exterior**. These are units that occur outside of the unit of interest. For an intrusive lithology, other lithologies the intrusion contacts should be classified as **Exterior**.

Unspecified intervals can be handled as **Ignored**, **Primary** or **Exterior**.

The additional compositing parameters determine how ignored segments flanked by interior or exterior segments are handled and the length of segments that will be filtered. Each of these settings is discussed below.

Click **OK** to create the table. Once you have created a composited table, you can edit it by right-clicking on it and selecting **Edit Composited Table**.

Converting Ignored Segments

The **Convert enclosed ignored segments** setting determines how ignored segments are handled when they are flanked by either two interior segments or two exterior segments. If **Convert enclosed ignored segments** is enabled, Leapfrog Geothermal will convert enclosed ignored segments to match the surrounding segments. In cases where an ignored segment does not lie between two interior or exterior segments, it will remain ignored.

If you wish to set a maximum size for ignored enclosed segments, tick the **Shorter than** box and set the maximum length.

If **Convert enclosed ignored segments** is disabled, this processing does not occur and ignored segments are never converted. When an intrusive contact surface is created, this setting is disabled by default.

For example, this scene shows two ignored segments that are flanked by the unit of interest. Because **Convert enclosed ignored segments** is disabled, the segments remain ignored:

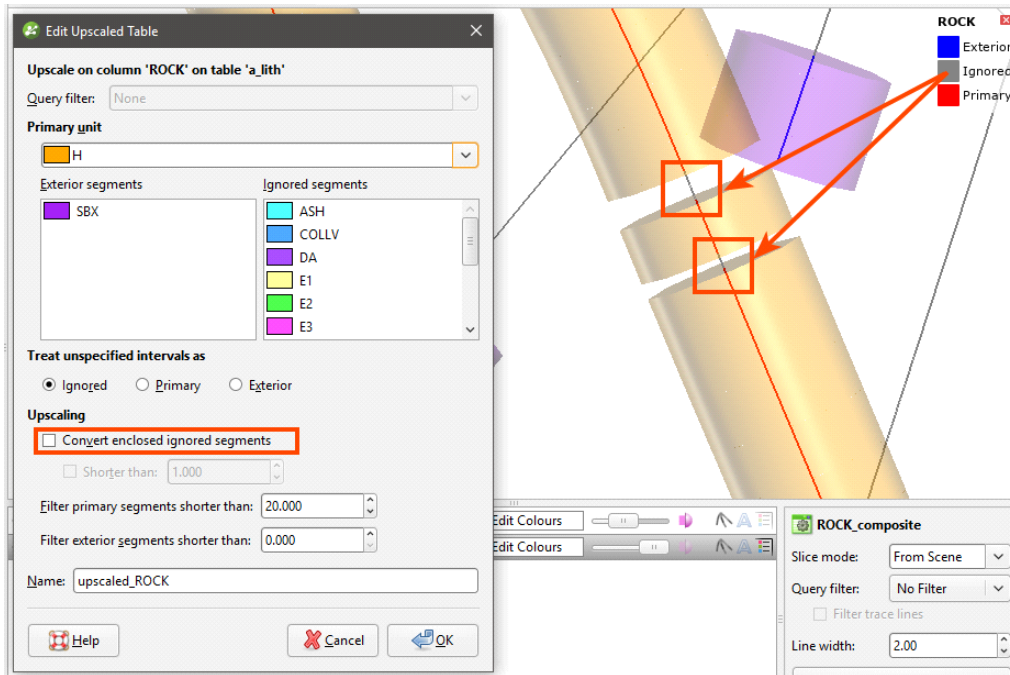

Enabling **Convert enclosed ignored segments** results in the segments being converted to the **Primary** unit:

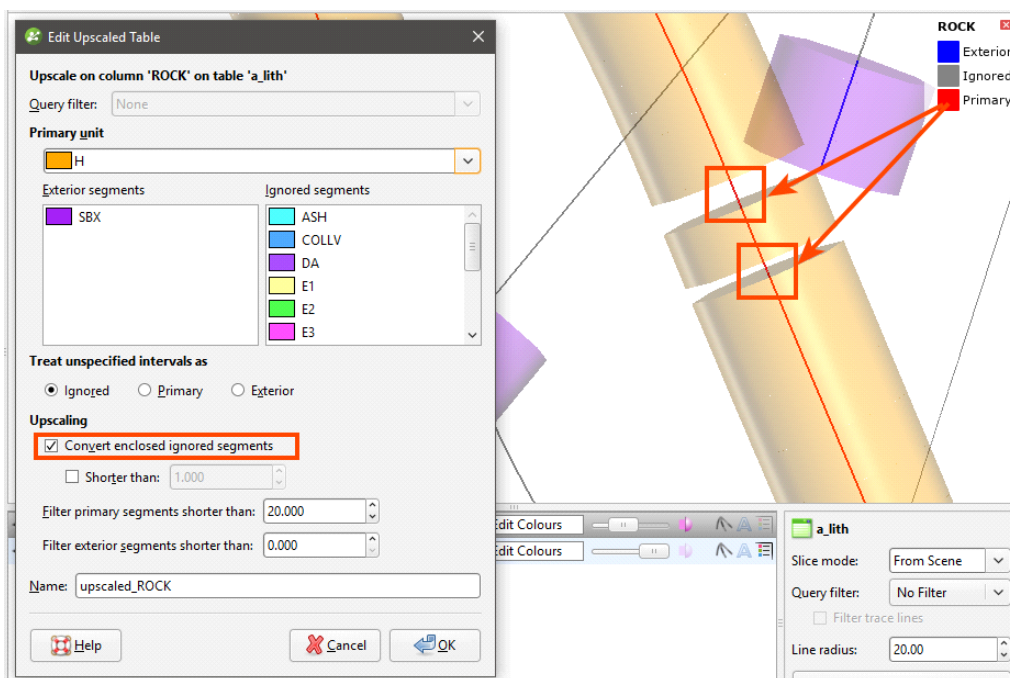

Enabling **Shorter than** and setting it to 4 results in the shorter segment being converted to the **Primary** unit and the longer segment remaining **Ignored**:

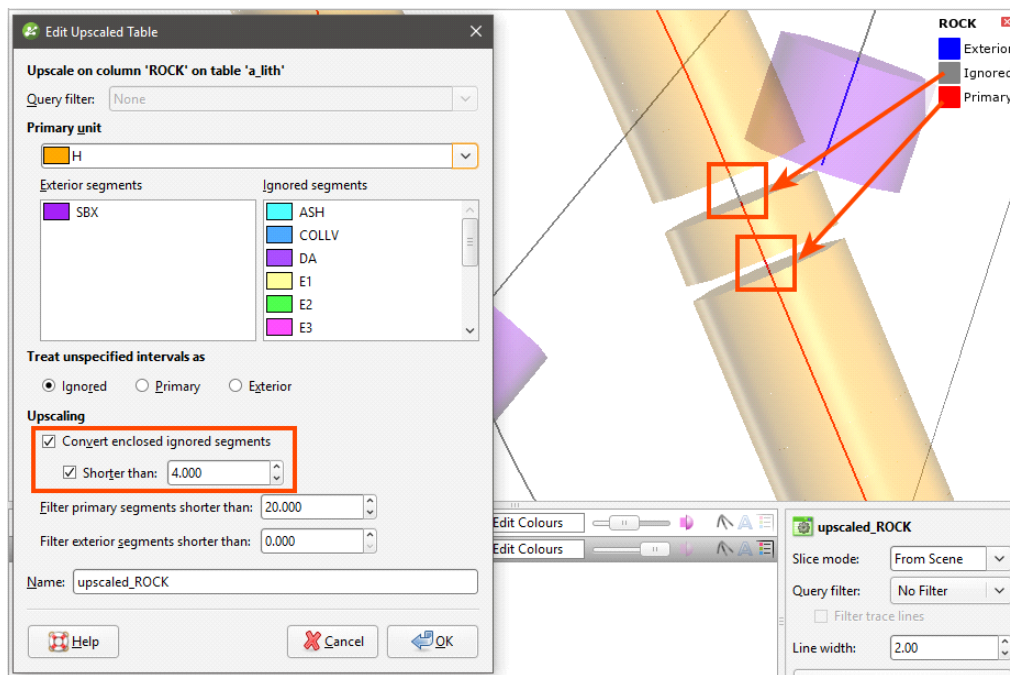

Zooming out, we can see that the ignored segments at the top of the wells have not been converted:

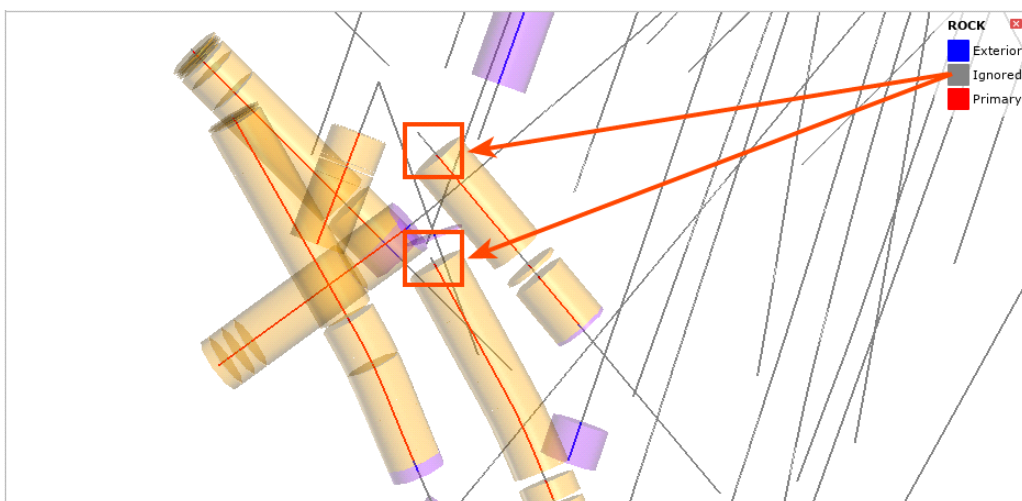

Filtering Short Segments

The **Filter primary segments** and **Filter exterior segments** parameters determine how short a segment must be before it is composited:

- Short **Exterior** segments flanked by **Primary** segments will be converted to **Primary** segments.
- Short **Primary** segments flanked by **Exterior** segments will be converted to **Exterior** segments.

When the value is set the zero, no segments will be converted.

To see how these parameters can smooth the shape of a unit of interest, let's look at a series of wells where we wish to create an intrusion boundary based on the red segments. Short segments are highlighted in the intervals that have not been composited:

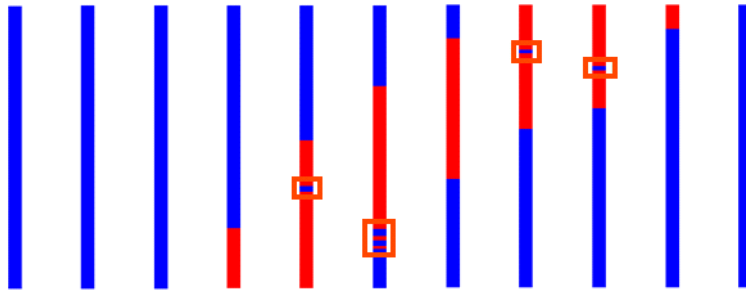

An intrusion generated from these intervals will have more detail than is necessary for modelling. However, when compositing settings are applied and the short intervals are converted, we can see that the intrusion boundary is more geologically reasonable:

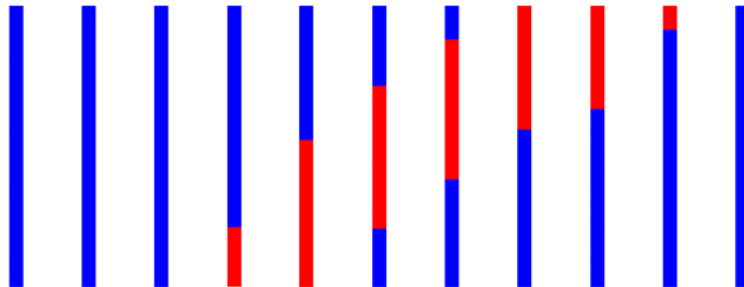

Viewing Category Composite Statistics

Once you have created a composited table, you can view statistics on the table. To do this, right-click on it and select **Statistics**. The following options are available:

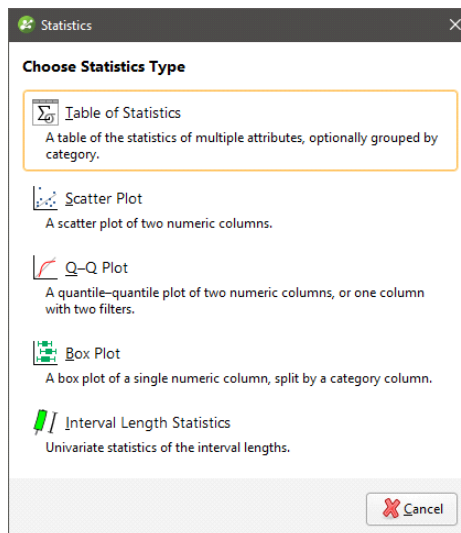

See the [Analysing Data](#) topic for more information on each option:

- [Table of Statistics](#)
- [Scatter Plots](#)

- [Q-Q Plots](#)
- [Box Plots](#)

The **Interval Length Statistics** graph is a univariate graph, so for more information on the options available, see [Univariate Graphs](#) in the [Analysing Data](#) topic.

Majority Composites

Category data can be composited into interval lengths from another table or into fixed interval lengths. The compositing is based on a majority percentage where each interval is assigned a category based on the category that makes up the highest percentage of the new interval. If two categories are equally represented, the category that occurs further up the well (closest to the collar) is assigned.

This is useful for comparing lithology and assay data; the intervals from an assay table can be applied to a category column to produce a new lithology column with the shorter intervals typical of assay tables. The majority composite column can then be used to create a merged table containing both lithology and assay data.

Well data is composited from the **Composites** folder, which is in the project tree as part of the **Wells** object. To create a majority composite, right-click on the **Composites** folder and select **New Majority Composite**. The **New Composited Table** window will appear:

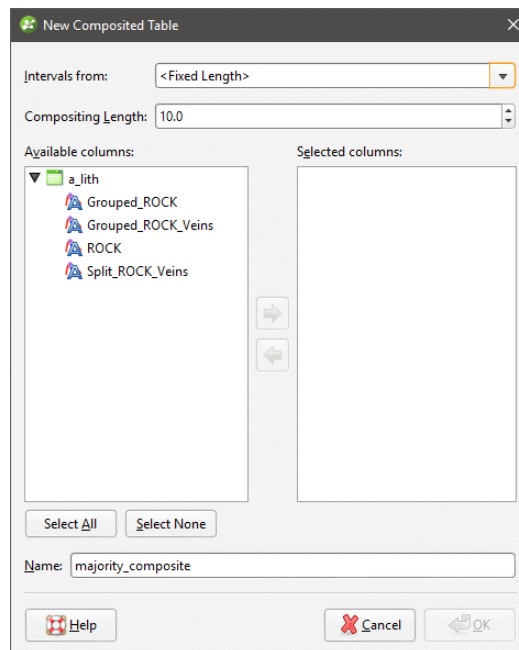

Select the interval table that will be used to specify the intervals for the new majority composite or specify a fixed **Compositing Length**. Next, select the columns that will be composited. Click **OK** to create the composite. The composite will be added to the **Composites** folder in the project tree. You can edit it by right-clicking on it and selecting **Edit Composited Table**.

Here assay intervals are shown inside the much longer lithology intervals. The selected interval goes from 14.0 to 23.7 metres:

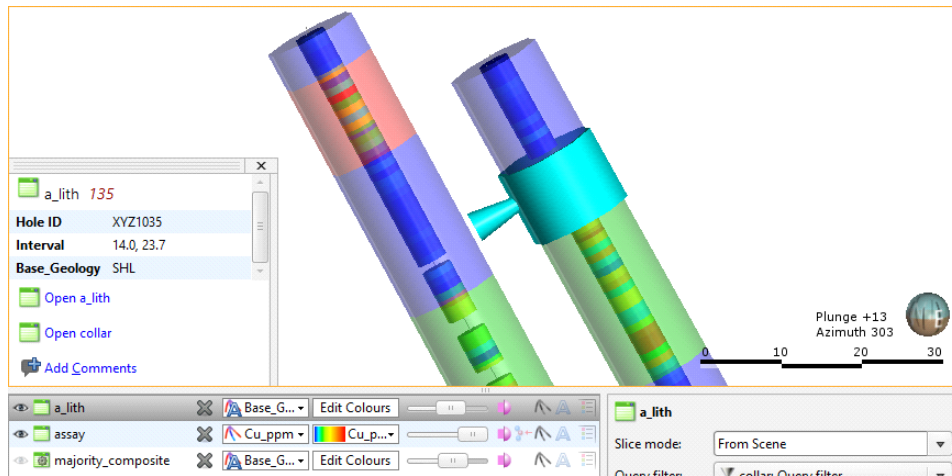

Here a majority composite has been created based on the lithology table using the assay table intervals. The category column displayed in the scene appears similar to the category column used to create it, but selecting an interval in the scene shows that the lithology has been composited into smaller intervals that match the assay intervals:

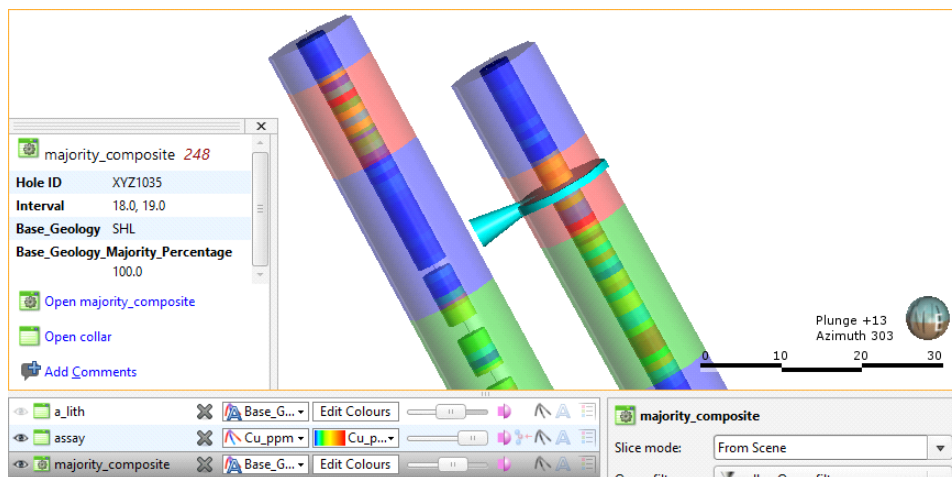

Viewing Majority Composite Statistics

Once you have created a composited table, you can view statistics on the table. To do this, right-click on it and select **Statistics**. The following options are available:

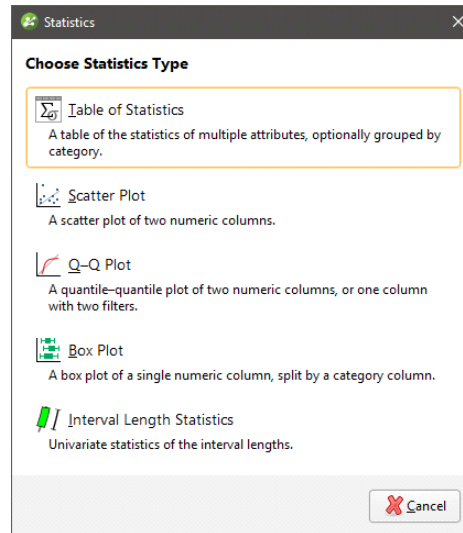

See the [Analysing Data](#) topic for more information on each option:

- [Table of Statistics](#)
- [Scatter Plots](#)
- [Q-Q Plots](#)
- [Box Plots](#)

The **Interval Length Statistics** graph is a univariate graph, so for more information on the options available, see [Univariate Graphs](#) in the [Analysing Data](#) topic.

Right-click on the numeric columns and select **Statistics** to view information about the composited values. See [Univariate Graphs](#) in the [Analysing Data](#) topic for more information.

Numeric Composites

Compositing numeric data takes unevenly-spaced well data and turns it into regularly-spaced data, which is then interpolated. Compositing parameters can be applied to entire wells or only within a selected region of the well. For example, you may wish to composite Au values only within a specific lithology.

There are two approaches to compositing numeric data in Leapfrog Geothermal:

- Composite the well data directly. This creates a new interval table that can be used to build models, and changes made to the table will be reflected in all models based on that table. This process is described below.
- Composites the points used to create an interpolant. This is carried out by generating an interpolant and then setting compositing parameters for the interpolant's values object. This

isolates the effects of the compositing as the compositing settings are only applied to the interpolant.

Intervals that have no data can have a significant effect when compositing data as they are ignored by the compositing algorithm. The effect of these missing intervals can be managed using the **Minimum coverage** parameter, but it's best to assign special values where intervals have no data. For example, intervals that are missing data can be assigned a value of 0 or that of the background mineralisation. See [Handling Special Values](#) for more information.

The rest of this topic describes compositing well data directly. It is divided into:

- [Creating a Numeric Composite](#)
- [Selecting the Compositing Region](#)
- [Compositing Parameters](#)
- [Setting the Sampling Method](#)
- [Selecting Output Columns](#)
- [Selecting Output Algorithms](#)
- [Viewing Numeric Composite Statistics](#)

Creating a Numeric Composite

To create a numeric composite, right-click on the **Composites** folder and select **New Numeric Composite**. The **New Compositing Table** window will appear:

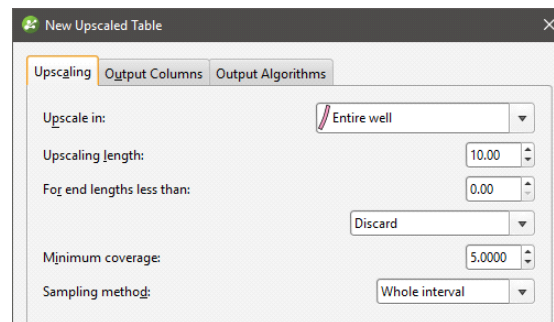

Set the compositing region and parameters; this is described in detail below. Then click on the **Output Columns** tab to select from the available columns of numeric data. Click **OK** to create the table.

Double-clicking on the table displays the data in its columns. Edit the table by right-clicking on it and selecting **Edit Compositing Table**.

Selecting the Compositing Region

Compositing parameters can be applied to entire wells or only within a selected region of the well. There are four options for selecting the region in which numeric data will be composited, and each is discussed below.

Compositing in the Entire Well

For this option, **Compositing Parameters** are applied to all values down the length of wells. Select **Entire well**, then set the compositing parameters.

Compositing in a Subset of Codes

If you wish to select specific category codes in which to composite numeric data, there are two options:

- **Subset of codes, grouped**
- **Subset of codes, ungrouped**

The difference between the two is that for the grouped option, the selected codes are combined and the same **Compositing Parameters** are applied to the grouped intervals:

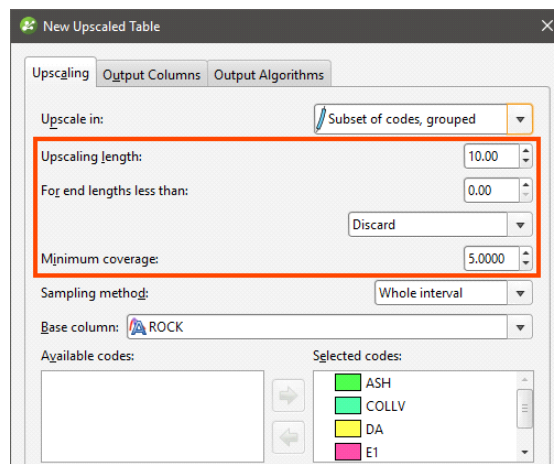

For the ungrouped option, however, you can set compositing parameters for each code in the selected **Base column**:

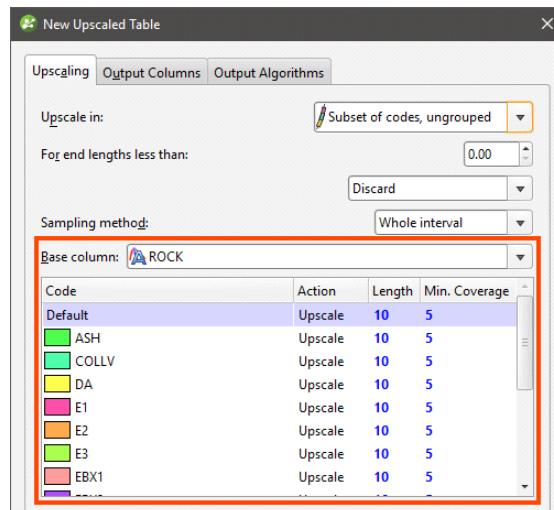

For the **Action** column, the options are:

- **Composite.** Numeric data that falls within the selected code will be composited according to the parameters set.

- **No compositing.** Numeric data is not composited within the selected code. The raw data will be used in creating the new data table.
- **Filter out.** Numeric data within the selected code will not be included in the new data table.

Compositing in Intervals

For the **Intervals from table** option, the interval lengths from the **Base table** are used to determine composite lengths. The value assigned to each interval is the length-weighted average value, and there are no further compositing parameters to set.

Compositing Parameters

When the compositing region is **Entire well, Subset of codes, grouped** or **Subset of codes, ungrouped**, the interval lengths are determined by applying three compositing parameters. These parameters are applied as follows:

- The wells are divided into intervals wherever numeric data occurs. The **Compositing length** determines the length of each composite interval, and the **Minimum coverage** length determines whether or not residual segments (those shorter than the **Compositing length**) are retained for further processing. Composite lengths are generated from the collar down the well, so any residual segments produced will be at the bottom of the well and where there is data missing down the length of the well. How residual segments are handled is described below.

Intervals that have no data can have a significant effect when compositing data as they are ignored by the compositing algorithm. The effect of these missing intervals can be managed using the **Minimum coverage** parameter, but it's best to assign special values where intervals have no data. For example, intervals that are missing data can be assigned a value of 0 or that of the background mineralisation. See [Handling Special Values](#) for more information.

- The **For end lengths less than** parameter is applied to determine what happens to the residual segments that may result from applying the **Compositing length** and **Minimum coverage** parameters. The three possibilities are [Discard](#), [Add to Previous Interval](#) and [Distribute Equally](#).
- Composite values are calculated for each composite interval. This is simply the length-weighted average of all numeric well data that falls within the composite interval.
- Composite points are generated at the centre of each composite interval from the composite values.

Discard

With the **Discard** option, residual segments that meet or exceed the **Minimum coverage** length are retained; those shorter are discarded.

For example, consider two wells. A is 49 metres long and B is 44 metres long. The **Compositing length** is set to 10 and the **For end lengths less than** length is set to 5. There will be a residual segment 9 metres long for Well A and one 4 metres long for Well B. Well A's residual segment

will be retained as a segment, whereas Well B's residual segment will be discarded. This results in:

- Well A: 10m, 10m, 10m, 10m, 9m (residual length > **Minimum coverage** length so the 9m segment is kept)
- Well B: 10m, 10m, 10m, 10m (residual length < **Minimum coverage** length so the 4m segment is discarded)

Add to Previous Interval

With the **Add to previous interval** option, the **Minimum coverage** length is automatically set to zero. Residual segments longer than the **For end lengths less than** value are retained as separate segments; those shorter are added to the previous interval.

For our two wells, when the **Compositing length** is 10, there will be a residual segment 9 metres long for Well A and one 4 metres long for Well B. When **For end lengths less than** is set to 5, Well A's residual segment will be retained as a segment, whereas Well B's residual segment will be added to the previous interval. This results in:

- Well A: 10m, 10m, 10m, 10m, 9m (residual length > **For end lengths less than** length so the 9m length is kept as a separate segment)
- Well B: 10m, 10m, 10m, 14m (residual length < **For end lengths less than** length so the 4m segment is added to the previous interval)

Distribute Equally

With the **Distribute equally throughout well** option, the **Minimum coverage** parameter is automatically set to zero. Residual segments longer than the **For end lengths less than** value are retained as separate segments; those shorter will have their length distributed among the other intervals.

For our two wells, Well A's residual segment will be retained as an individual segment, whereas Well B's residual segment will have its length distributed among the rest of the intervals. The segments for each composited well will be:

- Well A: 10m, 10m, 10m, 10m, 9m (residual length > **For end lengths less than** length so the 9m segment is kept as a separate segment)
- Well B: 11m, 11m, 11m, 11m (residual length < **For end lengths less than** length so the 4m length is distributed among the other intervals)

Setting the Sampling Method

There are two options for **Sampling method**:

- **Whole interval.** All data points in the composited interval are taken into account when calculating the composited value for that interval.
- **Dominant category.** A **Category column** is selected that determines whether or not data points in the composited interval are taken into account. Data points in the interval that do not occur in the dominant category are not used in calculating the composited value for that interval.

Selecting Output Columns

Click on the **Output Columns** tab to select from the available columns of data.

Selecting Output Algorithms

Click on the **Output Algorithms** tab to select the **Algorithm** and **0 replacement value** for each output column.

Available algorithms are **Arithmetic**, **Geometric**, **Harmonic**, **Max**, **Median** and **Min**.

Viewing Numeric Composite Statistics

Once you have created a composited table, you can view statistics on the table or for each individual column in the table.

To view statistics for the table, right-click on it and select **Statistics**.

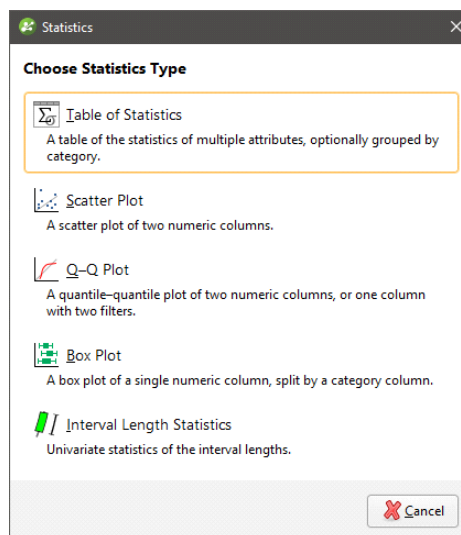

See the [Analysing Data](#) topic for more information on each option:

- [Table of Statistics](#)
- [Scatter Plots](#)
- [Q-Q Plots](#)
- [Box Plots](#)

The **Interval Length Statistics** graph is a univariate graph, so for more information on the options available, see [Univariate Graphs](#) in the [Analysing Data](#) topic.

Right-click on the table columns and select **Statistics** to view information about the composited values.

The first option displays statistics on the composited values; see [Univariate Graphs](#) in the [Analysing Data](#) topic for more information. The other two options display statistics comparing data before and after compositing.

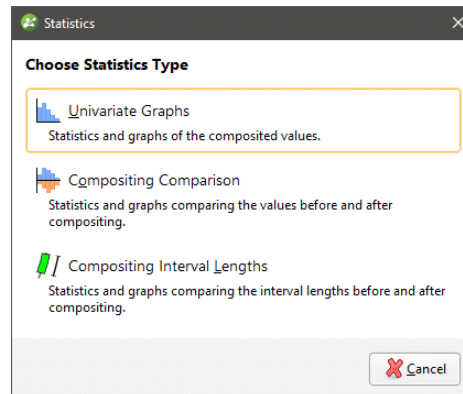

Compositing Comparison

The double histogram, one displaying the distribution of the raw data and one displaying the distribution of the composited data, enables comparison of the two distributions of the same element before and after the compositing transformation. Impacts on the symmetry of distributions will be evident.

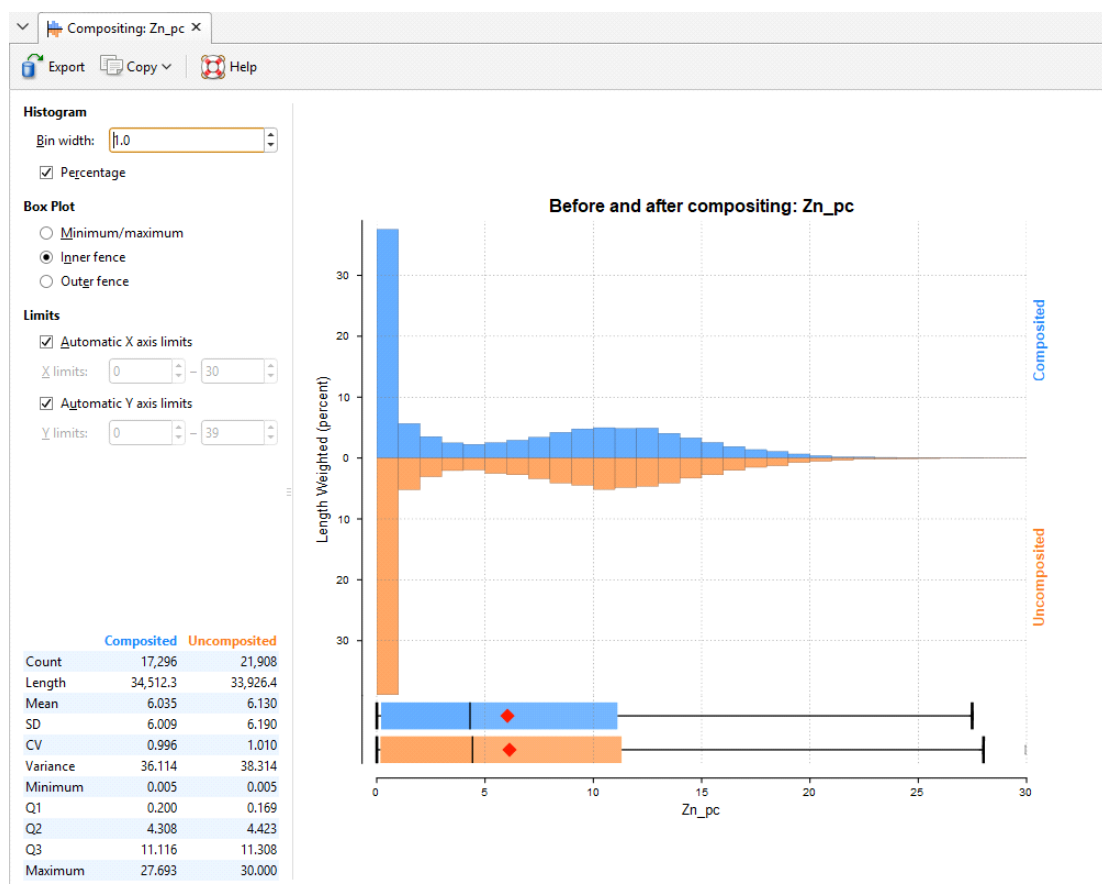

In the **Histogram** settings, **Bin width** changes the size of the histogram bins used in the plot. **Percentage** is used to change the Y-axis scale from a length-weighted scale to a percentage scale.

The **Box Plot** options control the appearance of the box plot drawn under the primary chart. The whiskers extend out to lines that mark the extents you select, which can be the **Minimum/maximum**, the **Inner fence** or the **Outer fence**. Inner and outer values are defined as being 1.5 times the interquartile range and 3 times the interquartile range respectively.

The **Limits** fields control the ranges for the X-axis and Y-axis. Select **Automatic X axis limits** and/or **Automatic Y axis limits** to get the full range required for the chart display. Untick these and manually adjust the **X limits** and/or **Y limits** to constrain the chart to a particular region of interest. This can effectively be used to zoom the chart.

The bottom left corner of the chart displays a table with a comprehensive set of statistical measures for the data set.

Compositing Interval Lengths

This graph shows a double histogram of distributions of the interval lengths before and after compositing.

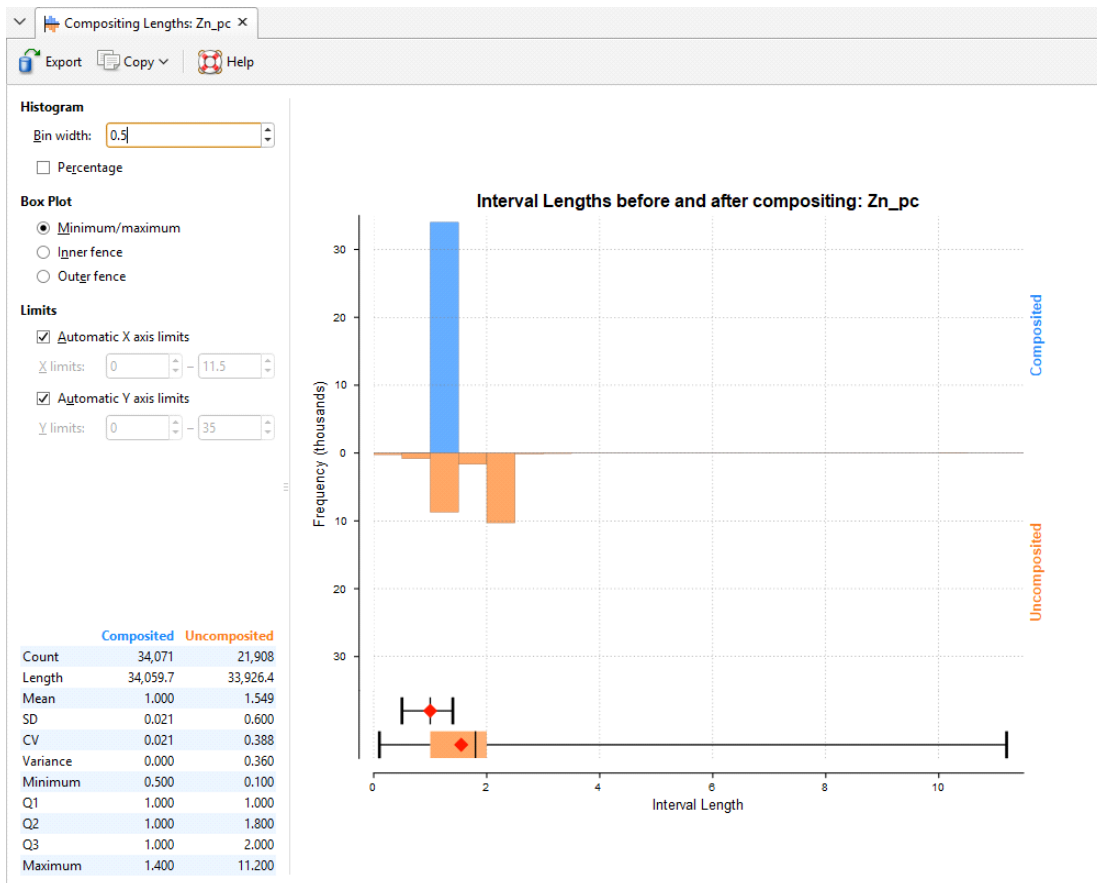

In the **Histogram** settings, **Bin width** changes the size of the histogram bins used in the plot. **Percentage** is used to change the Y-axis scale from a length-weighted scale to a percentage scale.

The **Box Plot** options control the appearance of the box plot drawn under the primary chart. The whiskers extend out to lines that mark the extents you select, which can be the **Minimum/maximum**, the **Inner fence** or the **Outer fence**. Inner and outer values are defined as being 1.5 times the interquartile range and 3 times the interquartile range respectively.

The **Limits** fields control the ranges for the X-axis and Y-axis. Select **Automatic X axis limits** and/or **Automatic Y axis limits** to get the full range required for the chart display. Untick these

and manually adjust the **X limits** and/or **Y limits** to constrain the chart to a particular region of interest. This can effectively be used to zoom the chart.

The bottom left corner of the chart displays a table with a comprehensive set of statistical measures for the data set.

Numeric Point Upscaling

Upscaling numeric point data works with downhole points and LAS points. To create a numeric point upscale, right-click on the **Upscaled Tables** folder and select **New Numeric Point Upscale**. The **New Upscaled Points Table** window will appear:

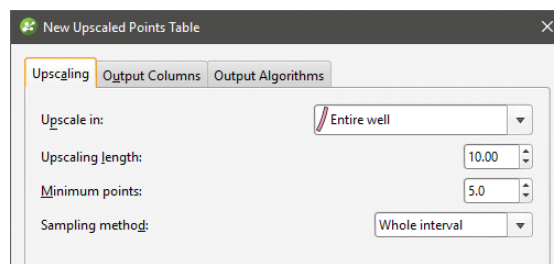

This topic describes the different parameters for upscaled points. It is divided into:

- [Selecting the Upscaling Region and Upscaling Length](#)
 - [Upscaling in the Entire Well](#)
 - [Upscaling in a Subset of Codes](#)
 - [Upscaling in Intervals](#)
- [Setting the Minimum Points](#)
- [Setting the Sampling Method](#)
- [Selecting Output Columns](#)
- [Selecting Output Algorithms](#)
- [Viewing Upscaled Points Statistics](#)

Selecting the Upscaling Region and Upscaling Length

Upscaling parameters can be applied to entire wells or only within a selected region of the well. There are four options for selecting the region in which numeric point data will be upscaled, and each is discussed below.

Upscaling in the Entire Well

For this option, all values down the length of wells are upscaled. Select **Entire well**, then set the **Upscaling length**. Upscale lengths are generated from the collar down the well.

Upscaling in a Subset of Codes

If you wish to select specific category codes in which to upscale numeric point data, there are two options:

- **Subset of codes, grouped**
- **Subset of codes, ungrouped**

The difference between the two is that for the grouped option, the selected codes are combined and the same **Upscaling length** and **Minimum points** parameters are applied to the grouped intervals:

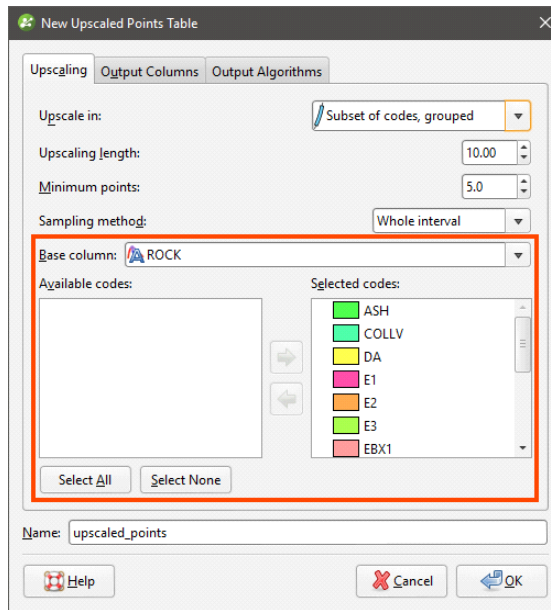

For the ungrouped option, however, you can set the **Upscaling length** and **Minimum points** parameters for each code in the selected **Base column**:

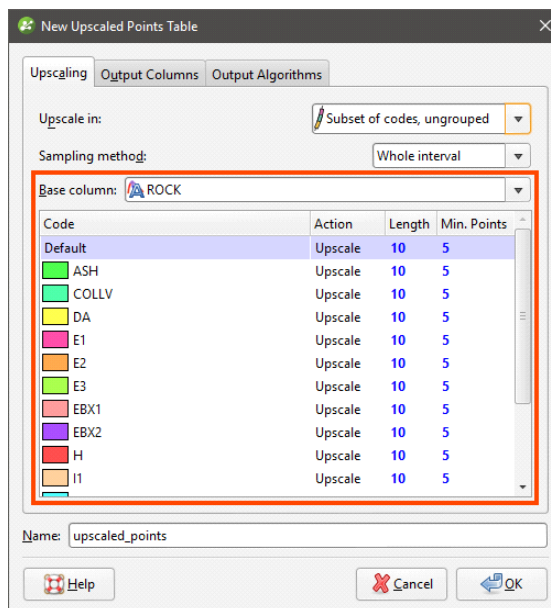

For the **Action** column, the options are:

- **Upscale.** Numeric point data that falls within the selected code will be upscaled according to the parameters set.
- **No upscaling.** Numeric point data is not upscaled within the selected code. The raw data will be used in creating the new data table.
- **Filter out.** Numeric point data within the selected code will not be included in the new data table.

Upscaling in Intervals

For the **Intervals from table** option, the interval lengths from the **Base table** are used to determine upscale lengths. The value assigned to each interval is the length-weighted average value, and there are no further upscaling parameters to set.

Setting the Minimum Points

The **Minimum points** parameter determines how many points are required for a valid upscaled interval to be created. Points are assigned a value according to where they fall in the upscaled interval; points that lie exactly on the border of an interval are assigned a weight of 0.5, whereas other points are assigned a weight of 1.

Setting the Sampling Method

There are two options for **Sampling method**:

- **Whole interval.** All data points in the upscaled interval are taken into account when calculating the upscaled value for that interval.
- **Dominant category.** A **Category column** is selected that determines whether or not data points in the upscaled interval are taken into account. Data points in the interval that do not occur in the dominant category are not used in calculating the upscaled value for that interval.

Selecting Output Columns

Click on the **Output Columns** tab to select from the available columns of data.

Selecting Output Algorithms

Click on the **Output Algorithms** tab to select the **Algorithm** and **0 replacement value** for each output column.

Available algorithms are **Arithmetic**, **Geometric**, **Harmonic**, **Max**, **Median** and **Min**.

Viewing Upscaled Points Statistics

Once you have created an upscaled table, you can view statistics on the table or for each individual column in the table.

To view statistics for the table, right-click on it and select **Statistics**.

See the [Analysing Data](#) topic for more information on each option:

- [Table of Statistics](#)
- [Scatter Plots](#)
- [Q-Q Plots](#)
- [Box Plots](#)

Right-click on the table columns and select **Statistics** to view information about the upscaled values.

Grouping Lithologies

The group lithologies tool lets you define a new unit to which existing units are added. For example, a sandstone deposit might appear in an interval table as poorly-sorted and well-sorted units. With the group lithologies tool, you can group both units into a single sandstone unit.

When you group lithologies, the original lithology column is preserved and a new lithology column is added to the interval table. You can then select the original lithology column or the new one when displaying data and creating models.

To start grouping two or more lithologies, right-click on the interval table in the project tree and select **New Column > Group Lithologies**. The **New Lithology Column** window will appear:

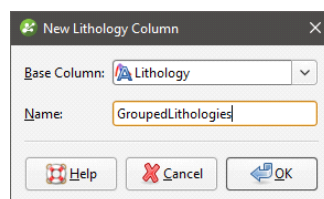

Select the lithology column you wish to use from the **Base Column** list, then enter a **Name** for the new lithology column. Click **OK**.

A window will appear displaying all lithologies in the base lithology column:

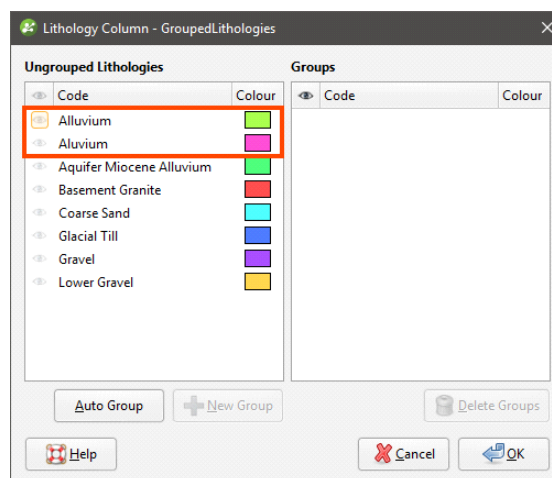

In this example, two spellings of Alluvium have been used and these lithologies should be combined into a single lithology.

The most straightforward way to group lithologies is to select the first of the lithologies, then click **New Group**. A group will be created for the selected lithology with only that lithology as a member:

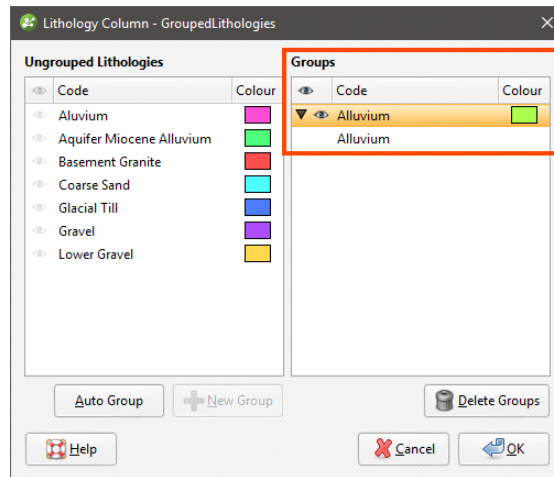

Next, click on a lithology in the **Ungrouped Lithologies** pane and drag it onto the group:

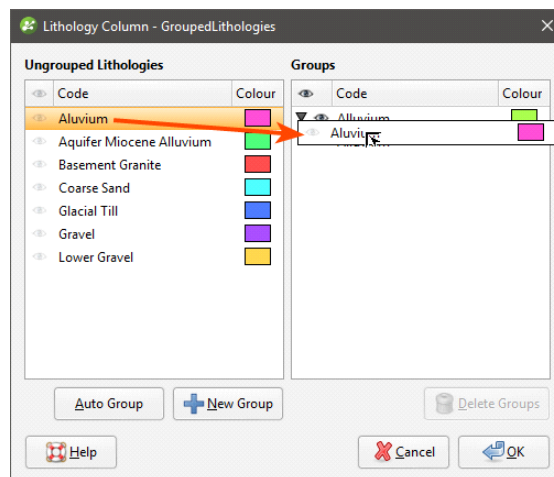

Grouping lithologies creates a new lithology column and any lithologies left in the **Ungrouped Lithologies** pane will be excluded from the new column. For this reason, once you have grouped the required lithologies, move all remaining lithologies to the **Groups** pane by clicking on each lithology, then on the **New Group** button. This will make each remaining lithology a new group with a single member:

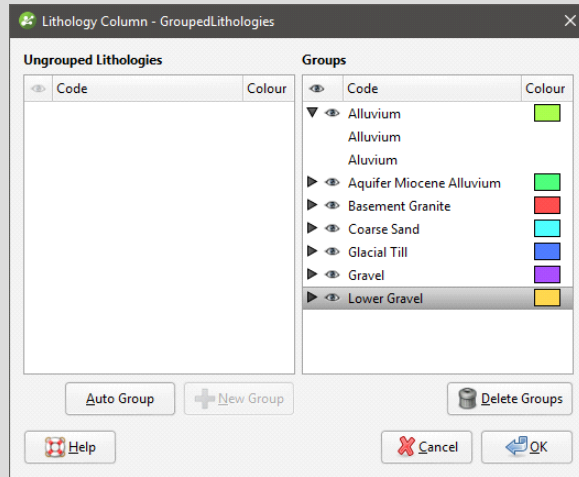

When you are finished, click **OK** to create the new lithology column. It will appear in the project tree as an additional lithology column in the interval table.

Select the new column from the shape list to display it:

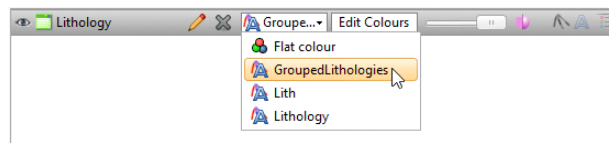

Click on the **Edit** button (pencil icon) to start editing the selected column.

The other way to group lithologies is to let Leapfrog Geothermal create the lithology groups.

Automatic Lithology Groups

Leapfrog Geothermal can automatically create lithology groups. To do this, create a new lithology column, as described above. Click the **Auto Group** button to reveal more options:

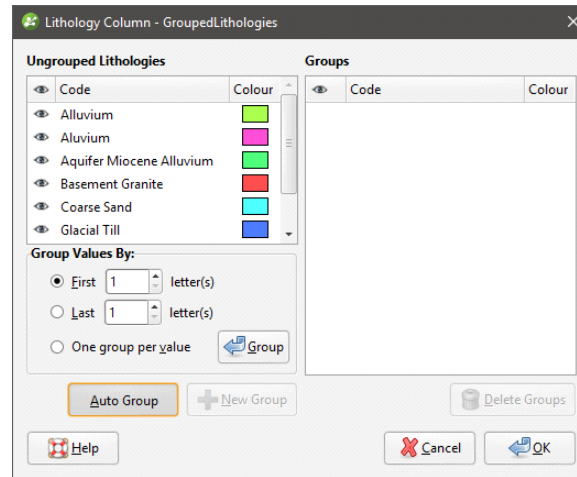

The **First letter(s)** and **Last letter(s)** options let you create groups according to the names of the existing lithologies. Click **Group** to create the new groups.

Here, the first two letters have been used to create a new set of lithologies:

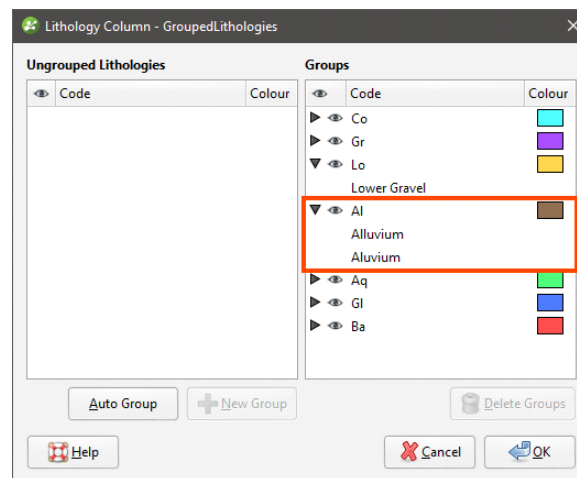

The two alluvium lithologies have been added to a single group.

The **One group per value** option creates a group for each original lithology. You can then drag and drop lithologies into different groups, move lithologies you do not wish to group back into the **Ungrouped Lithologies** pane and use the **Delete Groups** options to remove any empty groups.

Splitting Lithologies

With the split lithologies tool, you can create new units from a single unit by selecting from intervals displayed in the scene. When you split lithologies, the original lithology column is preserved and a new lithology column is added to the interval table. You can then select the original lithology column or the new one when displaying data and creating models.

The difference between the interval selection tool and the split lithologies tool is that with splitting lithologies, you are limited to selecting intervals from a single lithology. If you wish to select intervals from multiple lithologies, see [Interval Selection](#).

To start splitting a lithology, first add the well data to the scene. Then right-click on the interval table in the project tree and select **New Column > Split Lithologies**. The **New Lithology Column** window will appear:

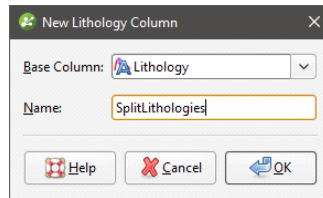

Select the lithology column you wish to use from the **Base Column** list, then enter a **Name** for the new lithology column. Click **OK**.

The **Lithologies and Splits** window will appear, together with a set of tools that will help you to select intervals in the scene:

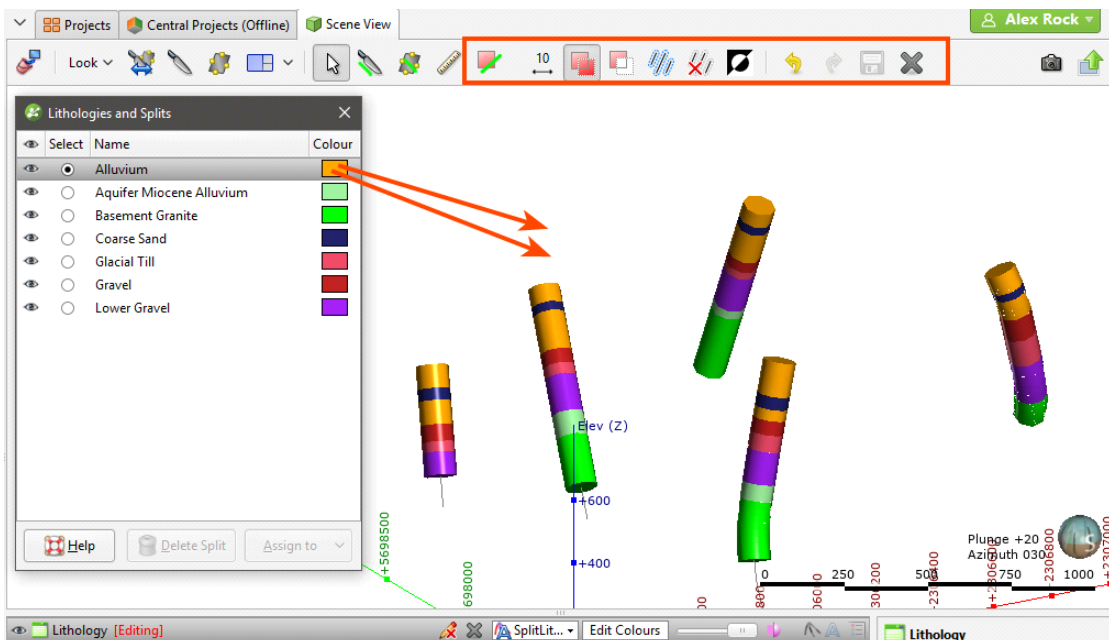

Alluvium (gold) appears both above and below Coarse Sand (blue) and so should be split into two separate lithologies.

The first step is to select the lithology that will be split in the **Lithologies and Splits** window. In the example above, Alluvium is already selected.

Next, click on the **Select Intervals** button (📏) and click the **Add Intervals** button (📏). In the scene, draw a line across each interval you wish to select.

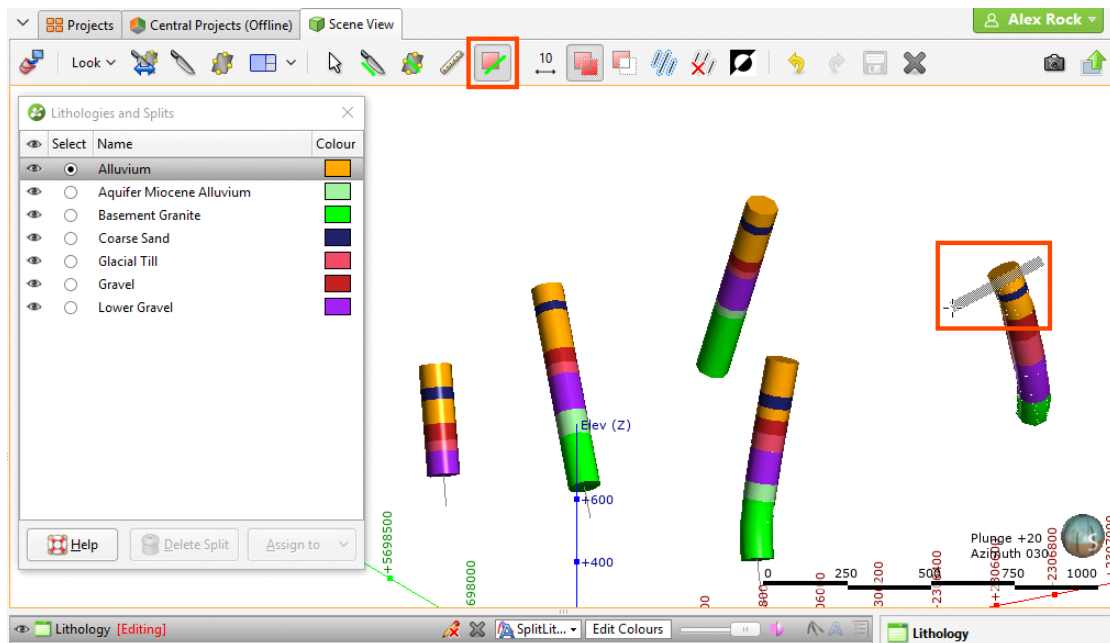

To change the width of the line used to select intervals, click on the **Change Line Width** button (📏) and enter a new value. You can keep the **Set Line Width** window open while you select intervals so you can change the line width as required.

Selected intervals are highlighted in the scene. If you accidentally select the wrong interval, either:

- Click the **Remove Intervals** button (📏) and draw across the interval once again.
- Hold the **Ctrl** key while drawing across the interval.

You can also:

- Select all visible intervals by clicking on the **Select All** button (📏) or by pressing Ctrl+A.
- Clear all selected intervals by clicking on the **Clear Selection** button (📏) or by pressing Ctrl+Shift+A.
- Swap the selected intervals for the unselected intervals by clicking on the **Invert Selection** button (📏) or by pressing Ctrl+I.

Once you have selected some segments, click on the **Assign to** button in the **Lithologies and Splits** window and select **Create New Split**:

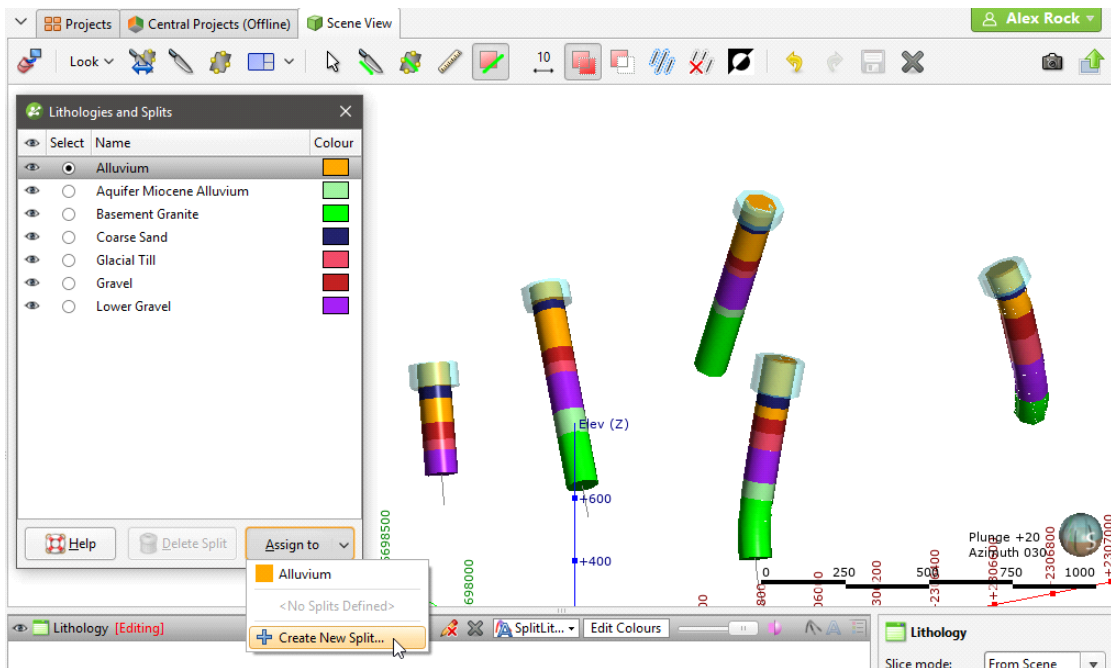

The **New Split** window will appear:

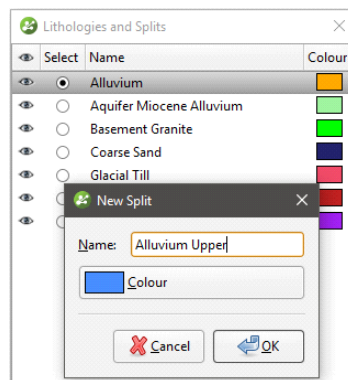

Enter a **Name** for the new lithology, then click **OK**. The new lithology will be created and the scene updated to reflect the changes:

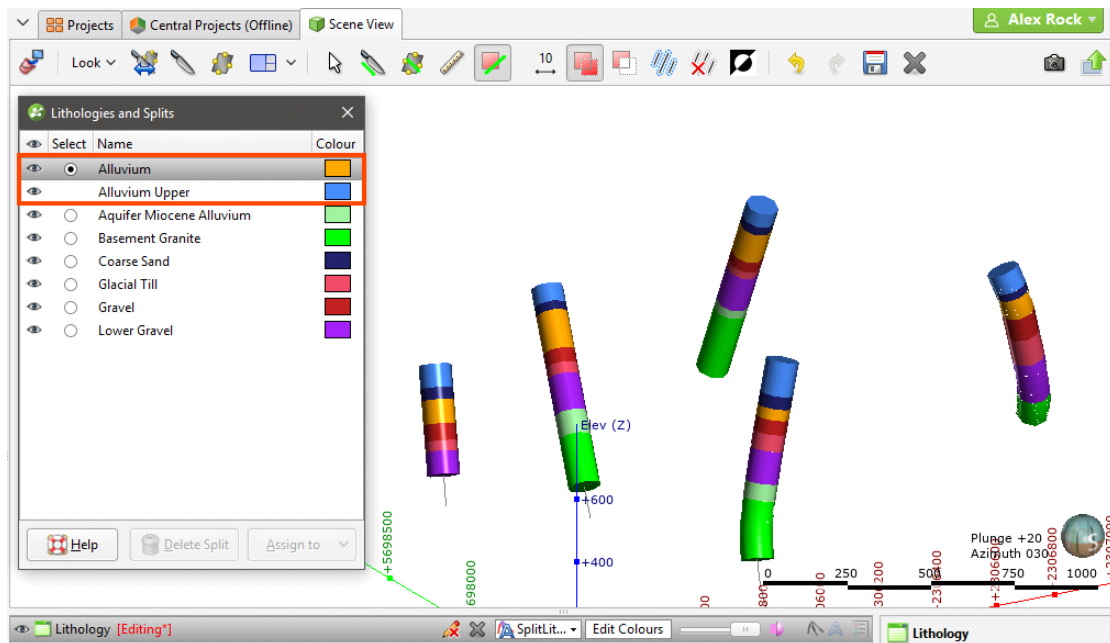

Once you have created a new lithology, you can add to it by selecting intervals, then selecting the lithology from the **Assign to** list.

When you are finished, click the **Save** button (📁) and close the **Lithologies and Splits** window. The new lithology column will appear in the project tree as an additional lithology column in the interval table.

Select the new column from the shape list to display it:

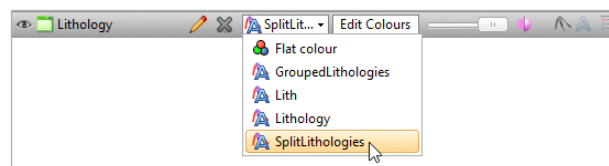

Click on the **Edit** button (🖌️) to start editing the selected column.

Interval Selection

When you wish to select a small portion of intervals or you don't have suitable parameters to use a query filter, you can select intervals from wells displayed in the scene to create a new lithology column. The original lithology column is preserved and a new lithology column is added to the interval table. You can then select the original lithology column or the new one when displaying data and creating models.

The difference between the interval selection tool and the split lithologies tool is that with splitting lithologies, you are limited to selecting intervals from a single lithology. With interval selection, you can choose intervals from any lithology displayed in the scene.

To start selecting intervals, first add the well data to the scene. Then right-click on the interval table in the project tree and select **New Column > Interval Selection**. For a merged table, right-click on it and select **Interval Selection**.

The **New Lithology Column** window will appear:

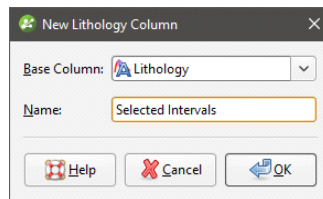

Select the lithology column you wish to use from the **Base Column** list, then enter a **Name** for the new lithology column. Click **OK**.

The **Interval Selection** window will appear, together with a set of tools that will help you to select intervals in the scene. To select intervals, click on the **Select Intervals** button (📏) and click the **Add Intervals** button (📏). In the scene, draw a line across each interval you wish to select:

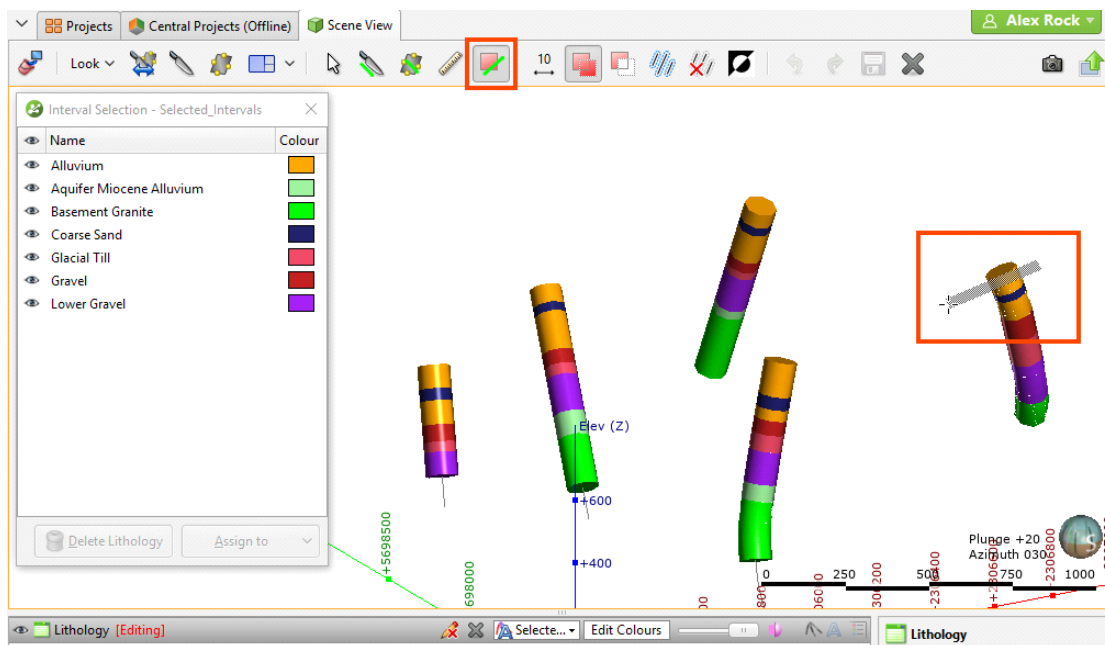

Selected intervals are highlighted in the scene. If you accidentally select the wrong interval, either:

- Click the **Remove Intervals** button (📏) and draw across the interval once again.
- Hold the **Ctrl** key while drawing across the interval.

You can also:

- Select all visible intervals by clicking on the **Select All** button (📏) or by pressing Ctrl+A.
- Clear all selected intervals by clicking on the **Clear Selection** button (📏) or by pressing Ctrl+Shift+A.
- Swap the selected intervals for the unselected intervals by clicking on the **Invert Selection** button (📏) or by pressing Ctrl+I.

To change the width of the line used to select intervals, click on the **Change Line Width** button () and enter a new value. You can keep the **Set Line Width** window open while you select intervals so you can change the line width as required.

When you have selected at least one interval, click on the **Assign to** button, then either select an existing lithology or create a new lithology by selecting **Create New Lithology**:

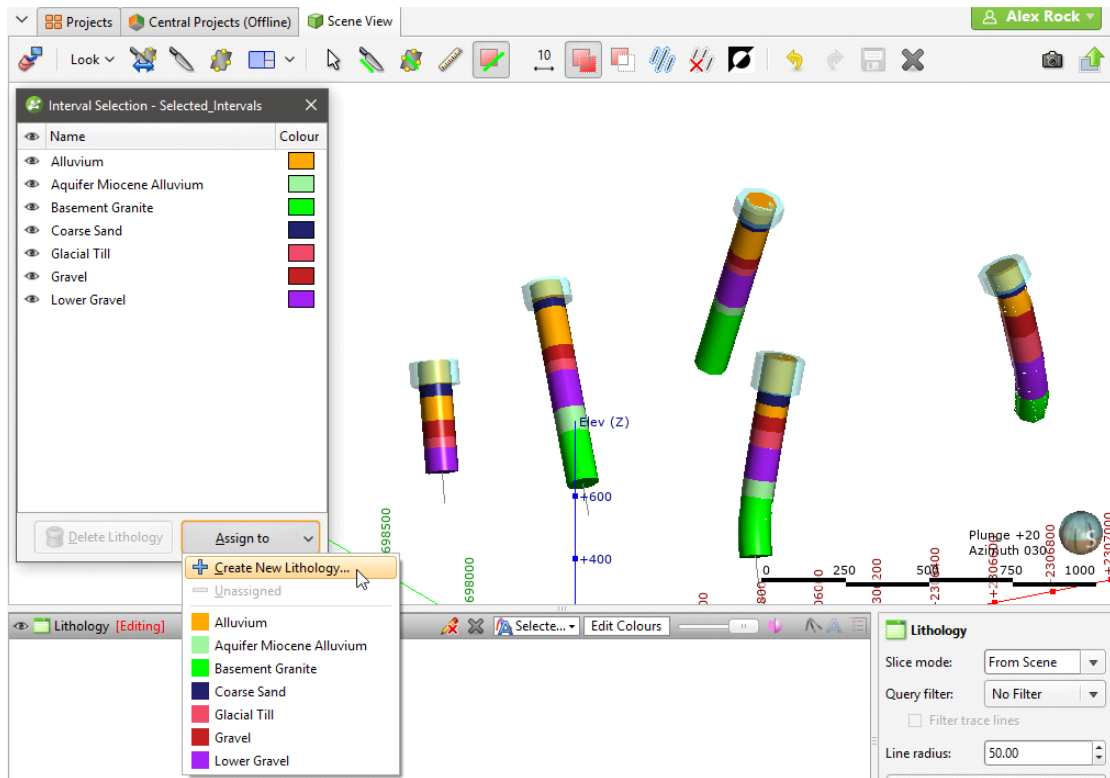

Enter a **Name** for the new lithology, then click **OK**:

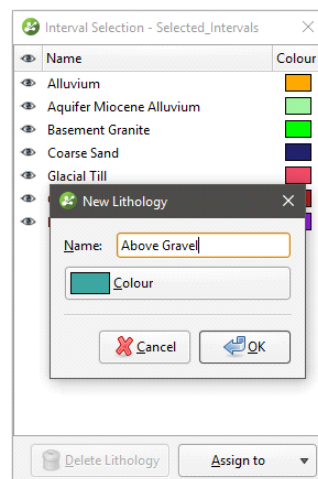

The new lithology will be created and the scene updated to reflect the changes:

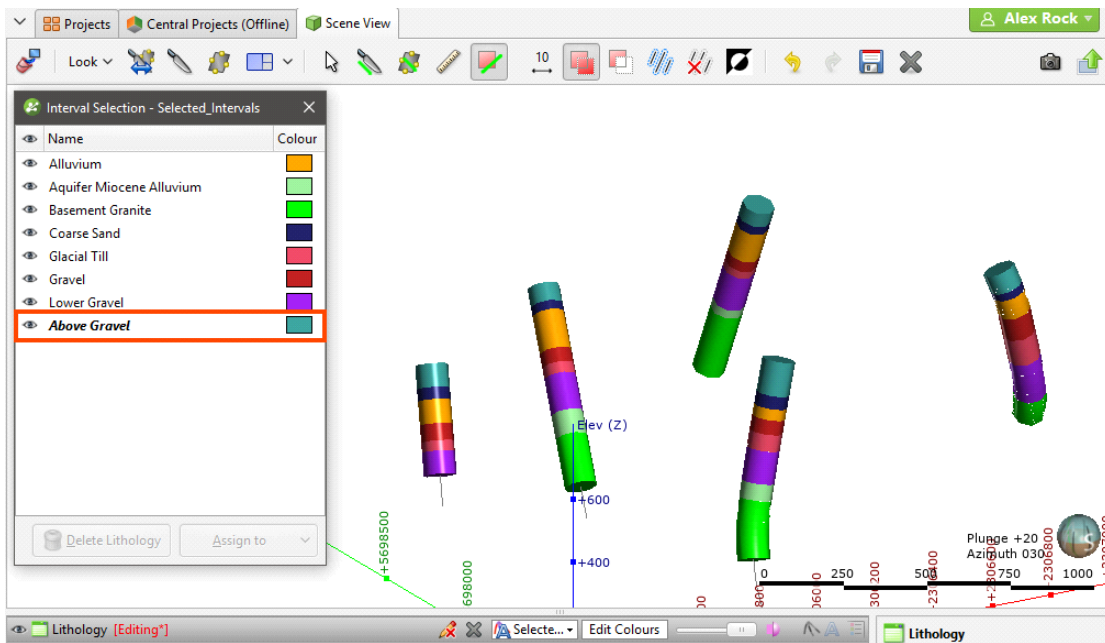

Once you have created a new lithology, you can add to it by selecting intervals, then selecting the lithology from the **Assign to** list.

When you are finished, click the **Save** button (📁) and close the **Interval Selection** window. The new lithology column will appear in the project tree as an additional lithology column in the interval table. Select the new column from the shape list to display it:

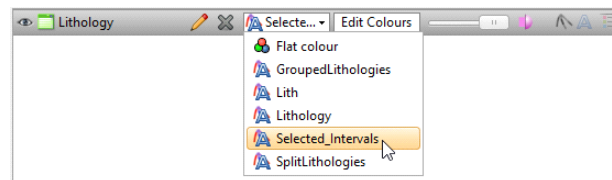

Overlaid Lithology Column

You may have two versions of an interval column, one that contains draft data and one that contains the final version. The final version may contain gaps, which can be filled in using the draft version. The overlaid lithology tool lets you combine the two columns to create a new column.

Both columns must be part of the same interval table. If they are not, use the merged table tool to create a new table that contains both columns. See [Merged Well Data Tables](#).

To create an overlaid lithology column, right-click on the interval table in the project tree and select **New Column > Overlaid Lithology Column**. For a merged table, right-click on it and select **Overlaid Lithology Column**.

The **New Overlaid Lithology Column** window will appear:

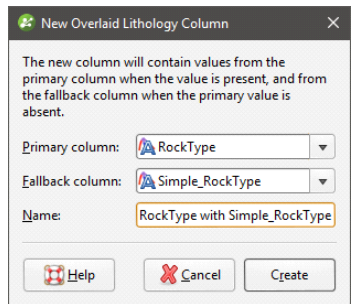

For the **Primary column**, select the column that you wish to have precedence. Data in the **Fallback column** will be used when no data is available from the **Primary column**.

Click **Create** to create the new column. The new column will appear in the project tree.

You can display well data with the new column by selecting it from the shape list:

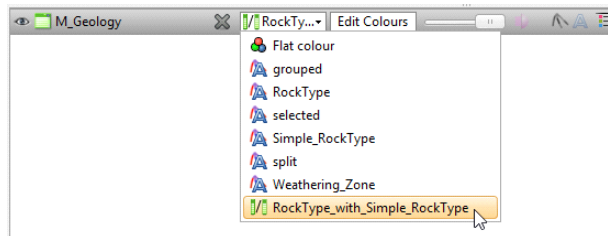

Category Column from Numeric Data

When you have numeric data you wish to use with the lithology and category modelling tools, you can convert the numeric data to a category column. To do this, right-click on the numeric data column and select **New Column > Category From Numeric**. In the window that appears, select the **Base Column**, then enter a name for the new column. Click **OK**.

The next step is to sort the numeric data into categories:

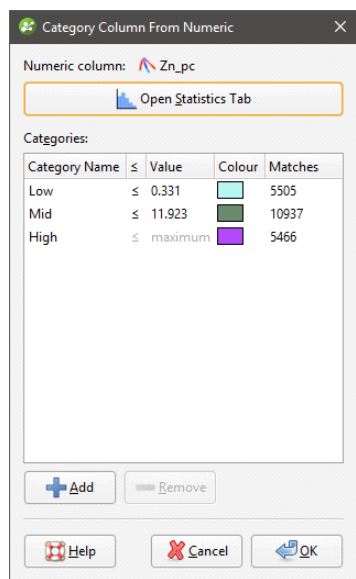

Leapfrog Geothermal automatically assigns three categories calculated from the distribution of data. To add a new category, click the **Add** button and enter the required value. Click the **Open Statistics Tab** button to view the distribution of data, which will help in deciding what categories to define. See [Univariate Graphs](#) in the [Analysing Data](#) topic for more information on using this tab.

Click **OK** to create the new column, which will appear in the project tree as part of the original interval table.

Back-Flagging Well Data

Evaluating geological models on wells creates a new lithology table containing the lithologies from the selected model. This is useful for validating models created from well data as you can generate statistics for the correlation between modelled geology and drilling data.

To create a back-flagged well data table, right-click on the **Wells** object in the project tree and select **New Evaluation**. The **New Evaluation** window will appear:

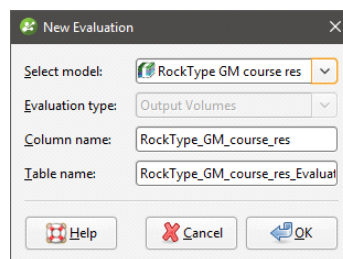

Select the model to use and enter names for the column and table.

When the selected model is a faulted model, the **Evaluation Type** setting determines whether the model's output volumes, faulted output volumes or fault blocks are evaluated.

Click **OK** to create the new table, which will appear in the project tree as part of the **Wells** object. The new table contains From, To and Lithology columns defined using the intersection between the model's output volumes and the wells.

For output volume evaluations, you can view the correlation between modelled geology and actual logged well segments. To do this, right-click on the table and select **Statistics**. In the **Correlation Statistics** window, you can compare model values to drilled lithologies or vice versa.

See:

- [Comparing Modelled Values to Drilling Lithologies](#)
- [Comparing Drilling Lithologies to Modelled Values](#)
- [Refining the Geological Model to Improve Correlation Statistics](#)

You can export the information displayed in the **Correlation Statistics** window in CSV format for use in other applications. To do this, click **Export**.

Comparing Modelled Values to Drilling Lithologies

Comparing **model values to drilling lithologies** shows how accurately drilling lithologies are modelled in the selected geological model. High matching percentages for drilling lithologies in the left-hand side of the window mean the model closely matches the drilling data for that lithology:

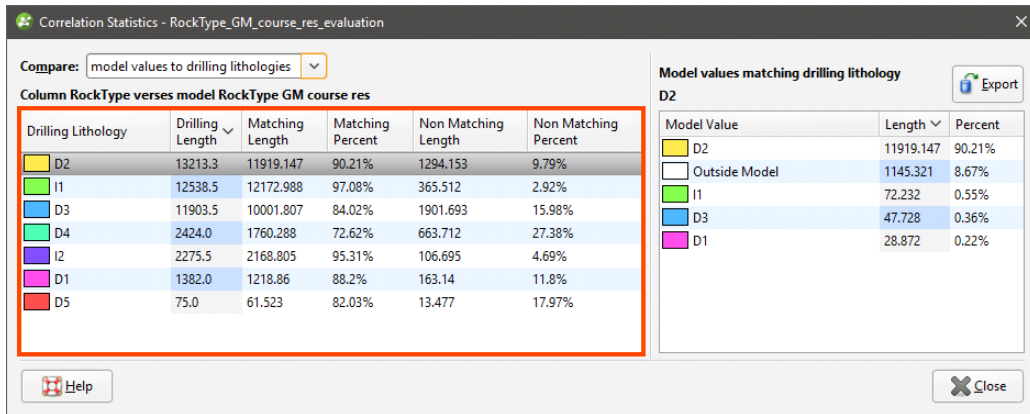

The right-hand side of the window shows the composition of the modelled values for the selected **Drilling Lithology**. Here, D1 in the geological model corresponds to D1 in the lithology data for 88.2% of the length of the well:

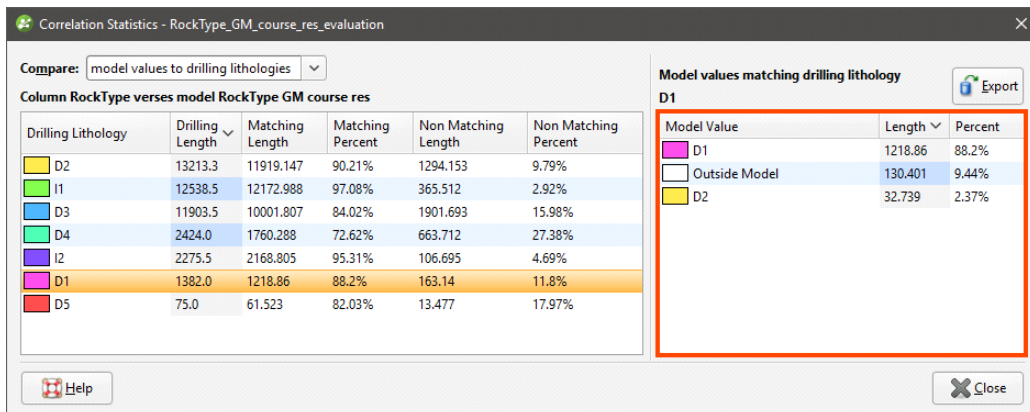

D1 in the model is actually D2 for 2.37% of the length of the wells, and 9.44% of the drilled D1 values fall outside of the boundary of the geological model.

In the images that follow, we will look at the correlation between the D5 drilling lithology and modelled D5. Here, two well data tables are displayed with the D5-D4 contact surface from the geological model:

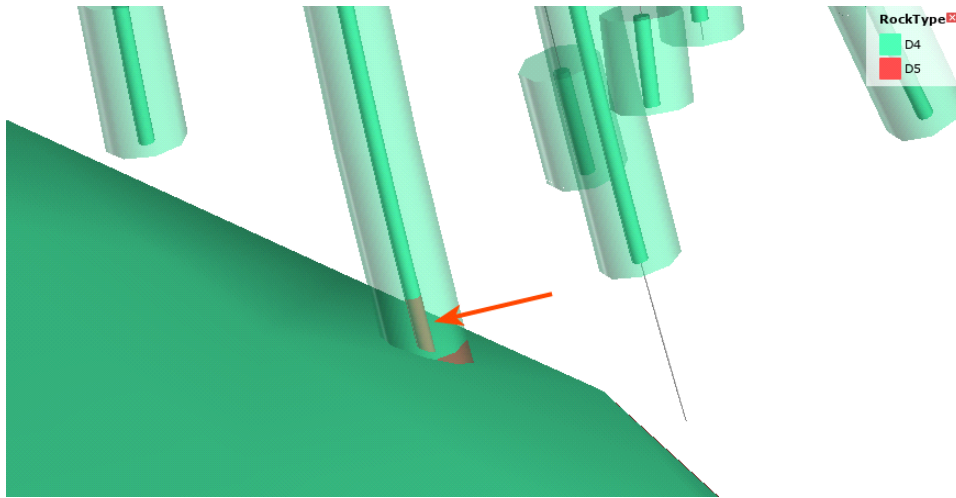

The inner wells show the original well data. The outer wells show the geological model back-flagged onto the well data table. In the highlighted well, we can see there is a discrepancy between the actual lithology data and that modelled. When we view correlation statistics for this model, we can see that this discrepancy is explained by the fact that 17.97% of the D5 drilling length is modelled as D4:

Correlation Statistics - RockType_GM_course_res_evaluation

Compare: model values to drilling lithologies

Column RockType versus model RockType GM course res

Drilling Lithology	Drilling Length	Matching Length	Matching Percent	Non Matching Length	Non Matching Percent
D2	13213.3	11919.147	90.21%	1294.153	9.79%
I1	12538.5	12172.988	97.08%	365.512	2.92%
D3	11903.5	10001.807	84.02%	1901.693	15.98%
D4	2424.0	1760.288	72.62%	663.712	27.38%
I2	2275.5	2168.805	95.31%	106.695	4.69%
D1	1382.0	1218.86	88.2%	163.14	11.8%
D5	75.0	61.523	82.03%	13.477	17.97%

Model values matching drilling lithology D5

Model Value	Length	Percent
D5	61.523	82.03%
D4	13.477	17.97%

Help Close

You might consider this an acceptable match, but if it is too low, there are several ways to refine the geological model so that the geological model more closely reflects the original wells, which are discussed below. For this example, we will adjust the resolution of the geological model. The modelled segment now corresponds more closely to the original well data:

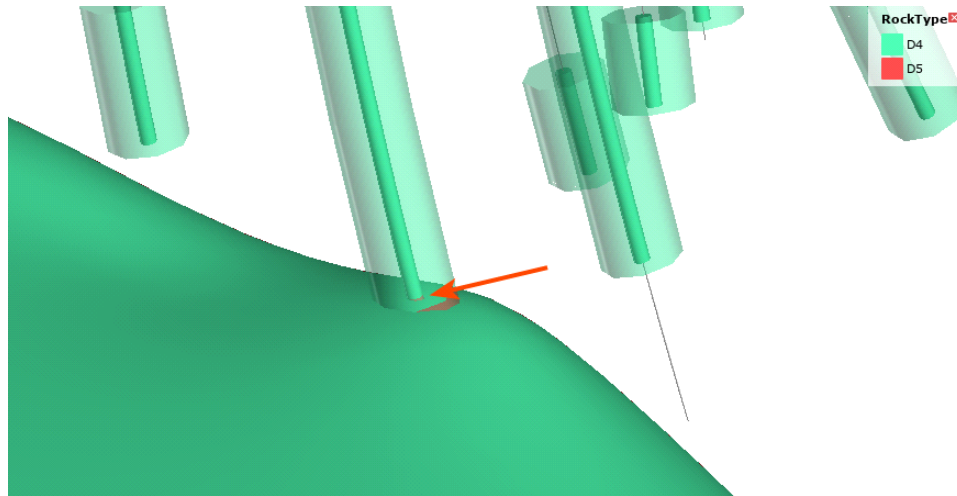

Viewing the correlation statistics shows that 99.62% of modelled wells now match the original data:

Correlation Statistics - RockType_GM_course_res_evaluation

Compare: model values to drilling lithologies

Column RockType verses model RockType GM course res

Drilling Lithology	Drilling Length	Matching Length	Matching Percent	Non Matching Length	Non Matching Percent
D2	13213.3	12048.174	91.18%	1165.126	8.82%
I1	12538.5	12310.02	98.18%	228.48	1.82%
D3	11903.5	10108.977	84.92%	1794.523	15.08%
D4	2424.0	1772.028	73.1%	651.972	26.9%
I2	2275.5	2271.957	99.84%	3.543	0.16%
D1	1382.0	1242.729	89.92%	139.271	10.08%
D5	75.0	74.716	99.62%	0.284	0.38%

Model values matching drilling lithology D5

Model Value	Length	Percent
D5	74.716	99.62%
D4	0.284	0.38%

Buttons: Help, Close, Export

Comparing Drilling Lithologies to Modelled Values

Comparing **drilling lithologies to model values** shows the lithological composition of modelled values. Again, high matching percentages in the left-hand side of the window mean the model closely matches the drilling data for that modelled lithology:

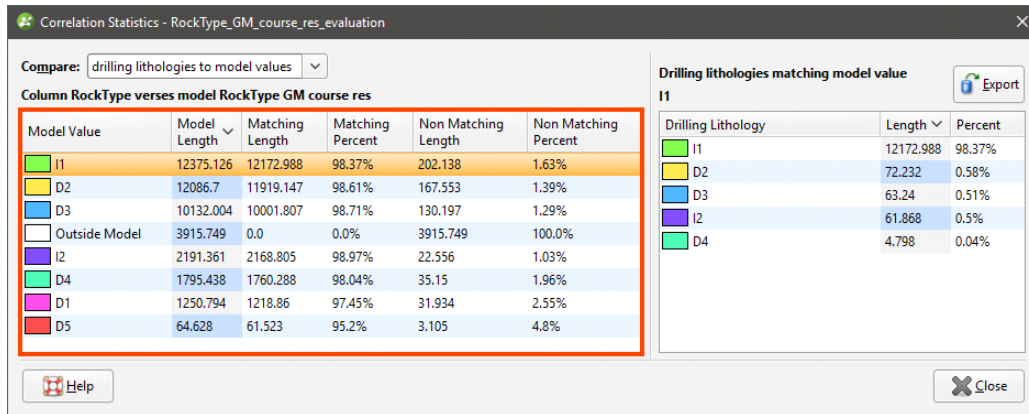

The non-matching percentage indicates how much of the modelled lithology is not the well lithology. You can see in the right-hand side of the window the lithologies that make up the non-matching portions of the modelled value.

In the images that follow, we will look at the correlation between the D5 drilling lithology and modelled D5 once again. The non-matching percentage is 4.8, and on the right-hand side of the window, we can see that this is exclusively drilling lithology I2:

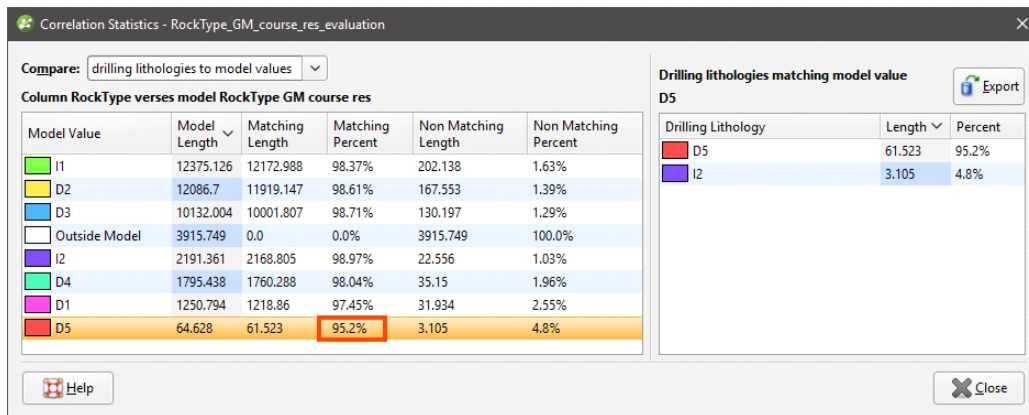

Adjusting the resolution of the geological model improves the matching percentage to the point where only 0.09 percent of the D5 modelled value is drilling lithology I2:

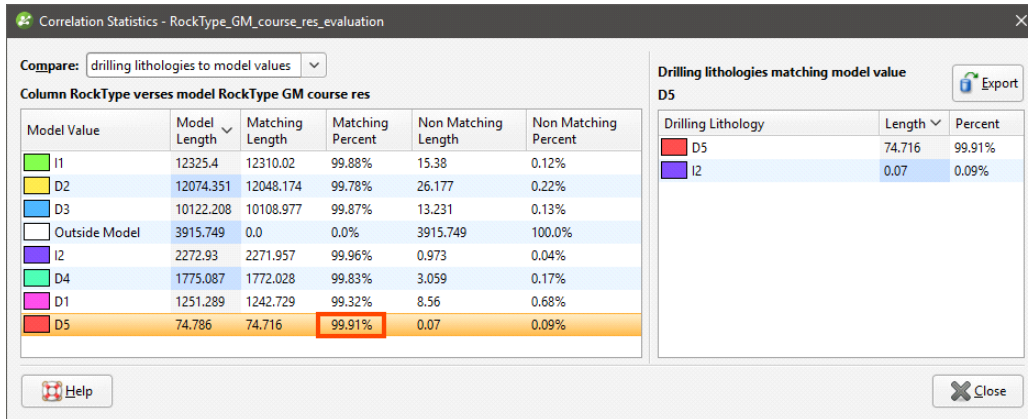

Refining the Geological Model to Improve Correlation Statistics

If the matching percentages are too low for the lithologies of interest, there are several ways to refine the geological model so that the geological model more closely matches the wells:

- Reduce the resolution of the geological model or of its contact surfaces. See [Surface Resolution for a Geological Model](#) and [Surface Resolution in Leapfrog Geothermal](#).
- Add more data to the model’s surfaces. See [Adding Data to Surfaces](#).
- Snap surfaces to the data used to create them. See [Honouring Surface Contacts](#).

Merged Well Data Tables

When you have more than one well interval table in a project, you can create a new table using selected columns from existing interval tables. You can include columns created by, for example, grouping or splitting lithologies or compositing.

To create a merged table, right-click on the **Wells** object in the project tree and select **New Merged Table**. The **New Merged Table** window will appear showing all interval columns available in the project:

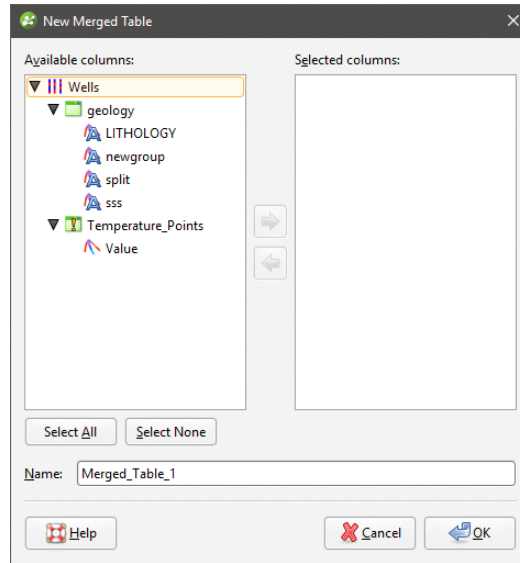

You can change the columns included once you have created the table.

Select the columns you wish to include in the new table and click **OK**. The new table will appear in the project tree as part of the **Wells** object.

You can create query filters for a merged data table, as described in the [Query Filters](#) topic. You can also select intervals (see [Interval Selection](#)) and create an overlaid lithology column (see [Overlaid Lithology Column](#)). You cannot, however, use the group lithologies and split lithology tools on a merged table.

To edit the table, right-click on it and select **Edit Merged Table**.

Core Photo Links

Leapfrog Geothermal can link well data to ALS Webtrieve and Coreshed core photo databases. When well data has been linked, a photo link object will appear in the project tree:

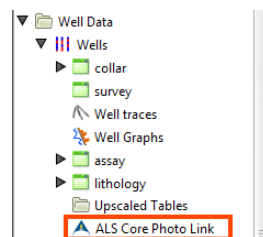

You can only have one type of core photo link associated with the well data. To add a link, right-click on the **Wells** object and select **Add Core Photo Link**. In the window that appears, select the core photo provider and click **OK**:

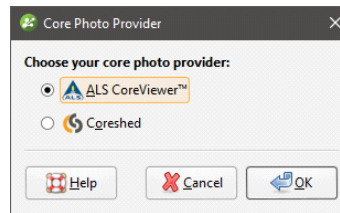

An alternative to linking to a core photo database is to link to files stored locally or on a network drive. This can be achieved by having a URL column in an interval table. When the interval is selected in the scene, you can click the link to view the file:

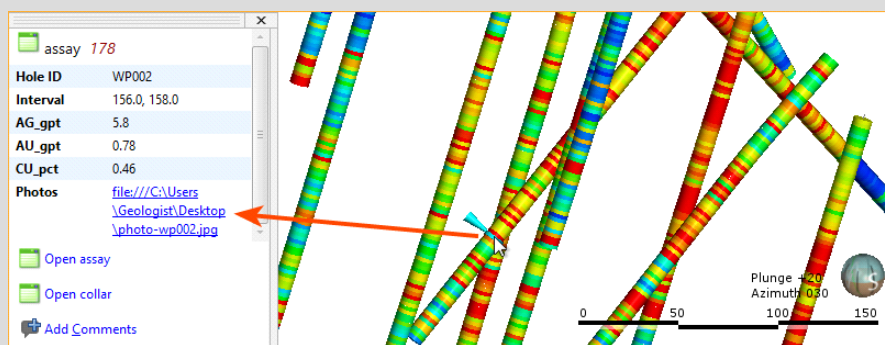

Use the prefix file:/// to link to local files.

For information on setting up ALS Webtrieve and Coreshed links, see:

- [Setting Up the ALS Interface](#)
- [Setting Up the Coreshed Interface](#)

To use the core photo links, see:

- [Using the ALS Interface](#)
- [Using the Coreshed Interface](#)

The ALS Core Photo Interface

This topic describes how to set up and use the ALS core photo interface. It is divided into:

- [Setting Up the ALS Interface](#)
- [Using the ALS Interface](#)
- [Removing the ALS Link](#)

Setting Up the ALS Interface

Before you can view core photos, you must first log in to the ALS database. Two levels of security are provided, one set up in Leapfrog Geothermal and the next via your browser.

To set up the interface between Leapfrog Geothermal and the ALS database, right-click on the **Wells** object and select **Add Core Photo Link**. In the window that appears, select **ALS Webtrieve** and click **OK**. The **ALS Core Photo Settings** window will appear. Information required to access core data is the **Project Name** and the **Encryption Key**. This information provides the first level of security for information in the ALS database. Click on each field and enter the required information. The information is case-sensitive, so ensure that the characters entered are correctly capitalised.

For **Leapfrog depths measured in**, ensure that the units used for depth match in Leapfrog Geothermal and ALS.

For **Open selection in new browser**, choose whether each core photo will be opened in a separate browser **Window** or **Tab**.

Click **OK** to save the information. If login is successful, the **ALS Core Photos** button (📄) will appear in the toolbar:

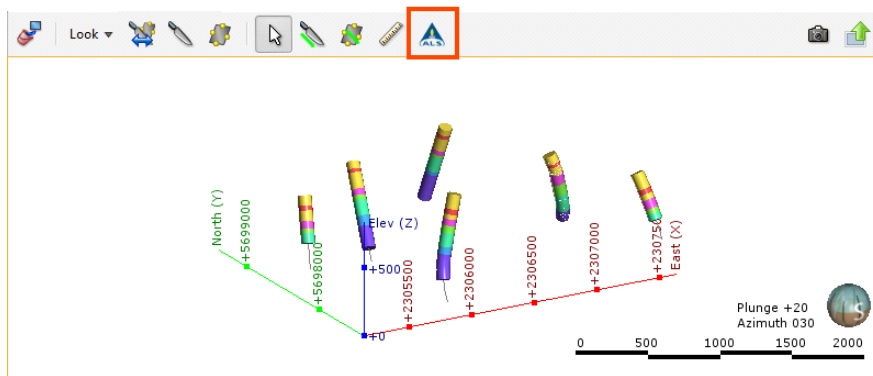

A link will also appear in the project tree as part of the **Wells** object:

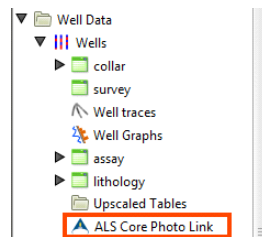

You can edit the link by double-clicking on it.

Using the ALS Interface

To view core photos, click on a well in the scene, then click on the **ALS Core Photo Link** button in the window that appears:

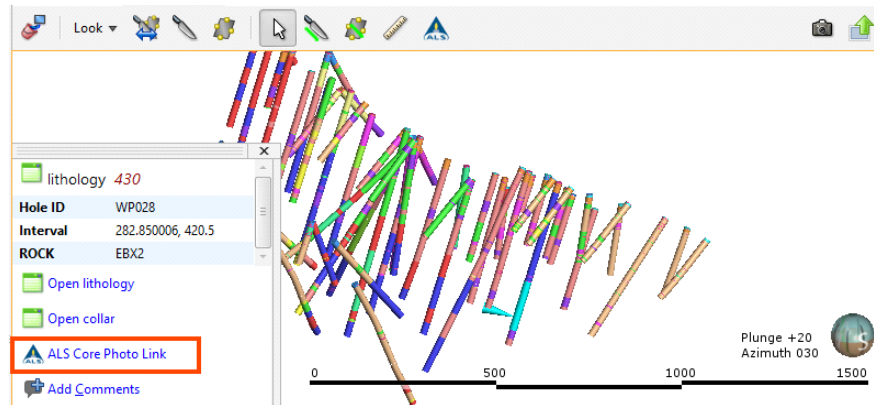

Your browser will be launched and you will be prompted to log in to the ALS database. Enter the **User Name** and **Password**, which are case-sensitive. Remember to allow the browser to save the details so that you will not be prompted to log in each time you wish to view a photo.

Your browser settings may require that you install a plugin or make changes to settings in order to view core photos. If you are not able to access the ALS database from Leapfrog Geothermal and have ensured your **Project Name**, **Encryption Key**, **User Name** and **Password** have been entered correctly, contact Customer Support as described in [Getting Support](#).

If you want to view core photos in rapid succession, click on the **ALS Core Photos** button (📷) in the toolbar, then click on a well in the scene. This will simultaneously:

- Display information on the segment selected in Leapfrog Geothermal
- Display the core photo in your browser

Removing the ALS Link

To remove an ALS link, right-click on it in the project tree and select **Delete**.

The Coreshed Core Photo Interface

This topic describes how to set up and use the Coreshed core photo interface. It is divided into:

- [Setting Up the Coreshed Interface](#)
- [Using the Coreshed Interface](#)
- [Removing the Coreshed Link](#)

Setting Up the Coreshed Interface

Before you can view core photos, you must first set up the Coreshed interface. To do this, right-click on the **Wells** object and select **Add Core Photo Link**. In the window that appears, select **Coreshed** and click **OK**. The **Coreshed Photo Settings** window will appear. Select whether each core photo will be opened in a separate browser **Window** or **Tab**.

Click **OK** to save the information. The **Coreshed Core Photos** button (🔄) will appear in the toolbar:

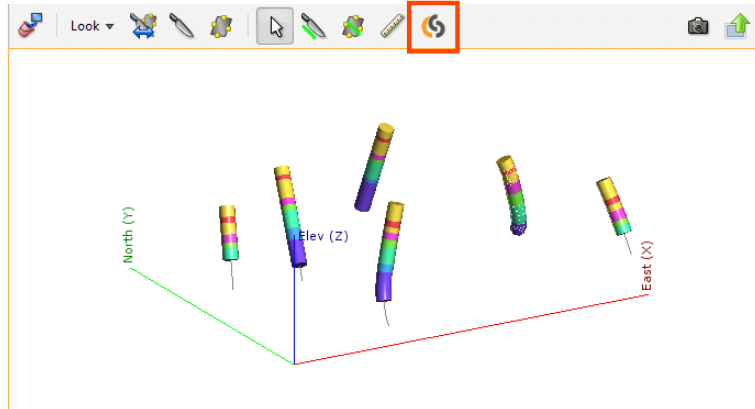

A link will also appear in the project tree as part of the **Wells** object:

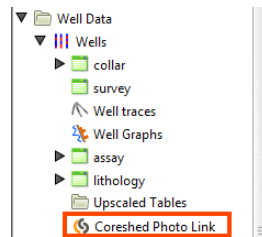

You can edit the link by double-clicking on it.

Using the Coreshed Interface

To view core photos, click on a well in the scene, then click on the **Coreshed Photo Link** button in the window that appears:

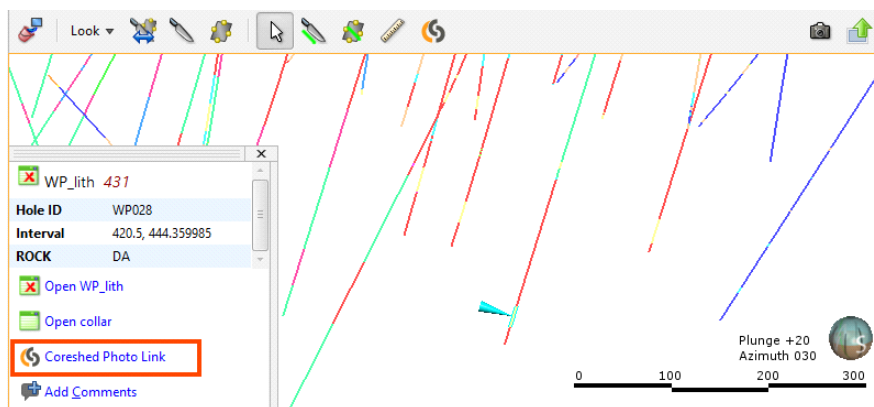

Your browser will be launched and you will be prompted to log in to the Coreshed database. Enter the **Username** and **Password**, which are case-sensitive. Remember to allow the browser to save the details so that you will not be prompted to log in each time you wish to view a photo.

Your browser settings may require that you install a plugin or make changes to settings in order to view core photos. If you are not able to access the Coreshed database from Leapfrog Geothermal and have ensured your **Username** and **Password** have been entered correctly, contact Customer Support as described in [Getting Support](#).

If you want to view core photos in rapid succession, click on the **Coreshed Photo Link** button () in the toolbar, then click on a well in the scene. This will simultaneously:

- Display information on the segment selected in Leapfrog Geothermal
- Display the core photo in your browser

Removing the Coreshed Link

To remove a Coreshed link, right-click on it in the project tree and select **Delete**.

Reloading Well Data

Reloading data is necessary when the imported data is modified externally. All well data can be reloaded by right-clicking on the **Wells** object and selecting **Reload Wells**. If you only need to reload a single table, right-click on that table and select **Reload Data**.

Reloading well data overwrites all existing well data. If you have data you wish to add to the project without overwriting existing data, use the **Append Wells** option.

The process is similar to that for importing well data:

- If the well data was loaded from a file on your computer or a network location, you will be prompted to specify the file locations.
- If the interval table is stored in an ODBC database, you will be prompted to connect to the database. See [Selecting the ODBC Data Source](#).
- If your well data is stored in an acQuire database, you will be prompted to connect to the database. See [Connecting to an acQuire Database](#).

When you reload data, Leapfrog Geothermal retains the table structure and refreshes the data contained in the tables. This ensures that you do not need to reassign the data type for each column and select the columns to be imported.

Exporting Well Data

Changes made to the well data in Leapfrog Geothermal only affect the Leapfrog Geothermal database, not the original data files. You can export Leapfrog Geothermal well data, which is useful if you wish to keep a copy of well data outside the project.

You can:

- Export all data. See [Exporting All Well Data](#).
- Export only a single data table. See [Exporting a Single Well Data Table](#).

These export options export the well data tables using To and From values to indicate location information. If you wish to export data with X-Y-Z values, extract points data using one of the following options:

- [Extracting Contact Points from Well Data](#)
- [Extracting Intrusion Values from Well Data](#)
- [Extracting Interval Midpoints from Well Data](#)

Then export the data object as described in [Exporting Points Data](#).

Exporting All Well Data

To export all well data, right-click on the **Wells** object and select **Export**. The **Export Well Data** window will appear:

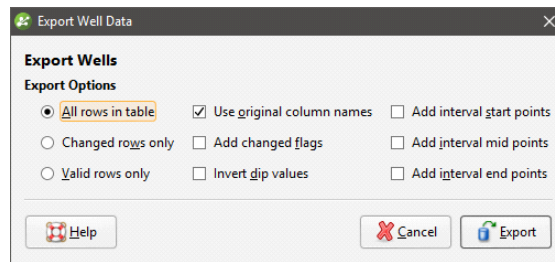

Once you have selected how you wish to export the data, click **OK**. The **Export Well Data Files** window will appear:

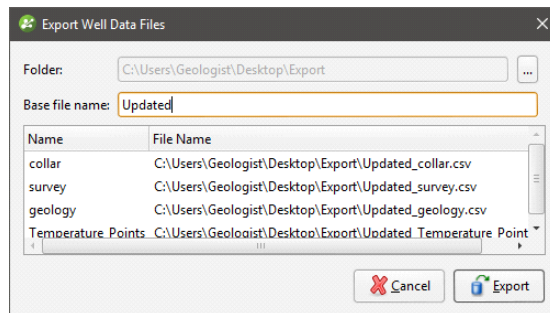

The list shows the files that will be created, one for each data table. Choose the **Folder** where the files will be saved, then enter a **Base file name**, which will be added to the front of each file name.

Click **Export** to save the files.

Exporting a Single Well Data Table

To export a single well data table, right-click on that table and select **Export**. The **Export Well Data** window will appear:



Once you have selected how you wish to export the data, click **OK**. You will be prompted for a filename and location.

Points Data

Points are sets of X-Y-Z coordinates, with or without associated values. In Leapfrog Geothermal, points are used to define surfaces and for interpolation. You can use the **Points** folder to:

- Import points data
- Extract contact points, intrusion values and interval midpoints from well data
- Create guide points
- Create grids of points that can be evaluated against geological and numeric models and exported for use in other modelling

Geophysical points should be imported into the **Geophysical Data** folder rather than into the **Points** folder. See [Geophysical Data](#).

The rest of this topic describes importing and exporting points, setting elevation for points and evaluating points. It is divided into:

- [Importing Points Data](#)
- [Reloading Points Data](#)
- [Appending Points Data](#)
- [Importing a Column](#)
- [Setting Elevation for Points](#)
- [Evaluating Points Data](#)
- [Displaying Points](#)
- [Viewing Points Table Statistics](#)
- [Exporting Points Data](#)

Importing Points Data

Leapfrog Geothermal supports the following file types for points data:

- CSV files (*.csv)
- ASCII text files (*.asc)
- DXF files (*.dxf)
- Leapfrog Geothermal 3D Point Data files (*.pl3, *.ara)

Points data can be imported from:

- Files stored on your computer or a network location. Right-click on the **Points** folder and select **Import Points**. You will be prompted to select a file.

- From any database that runs an ODBC interface. Right-click on the **Points** folder and select **Import Points via ODBC**. See [Selecting the ODBC Data Source](#) below.

For each of these options, once the data source is selected, the process of importing the data is the same.

When importing a file that has multiple features, you will be prompted to select which ones to import. You can also choose to:

- Import the features as separate objects. Each feature will appear in the project tree as a separate object.
- Flatten all features into one object. Leapfrog Geothermal will treat all features as a single object.

Once imported, the file will be added to the **Points** folder. If there are errors in the data, the errors can be corrected as described in [Correcting Data Errors in Leapfrog Geothermal](#).

To view the imported data, double-click on the object that has been added to the **Points** folder.

Once points data has been imported to the project, it can be modified and evaluated against geological and numeric models, as described in [Evaluating Points Data](#).

Selecting the ODBC Data Source

When importing points data from an ODBC database, you will need to specify the ODBC data source. Enter the information supplied by your database administrator and click **OK**.

Once the data source is selected, the import process is similar to that described above.

Reloading Points Data

Reloading data is necessary when the imported data is modified externally. Points data can be reloaded by right-clicking on the table and selecting **Reload Data**.

Reloading points data overwrites all data in the existing table. If you have data you wish to add to the project without overwriting existing data, use the **Append Data** option.

The process is similar to that for importing the original table.

Appending Points Data

If points data is stored in multiple files, you can import these files into the project and add them to existing points data. To do this, right-click on the object you wish to append and select **Append Data**. You will be prompted to select a file.

Next, the **Import Tables For Appending** window will be displayed.

Check the data to ensure that the correct information will be imported, then click **Finish** to add the new file.

Importing a Column

Columns of points data that were not imported when the original data was imported or that are stored in a separate file can be added to the table at any time. To do this, right-click on the points table in the project tree and select **Import Column**.

The process is similar to importing the original table; select the file and map the columns you wish to import.

Setting Elevation for Points

You can set the elevation for points tables by projecting them onto a surface. This overwrites elevation values in the z column of the points table, using the data from the selected surface. If the surface does not intersect vertically with all points, you can choose how the z values for those unprojected points will be handled.

To set the elevation for points from a surface, right-click on the points object in the project tree and select **Set Elevation**. The **Set Elevation** window will appear:

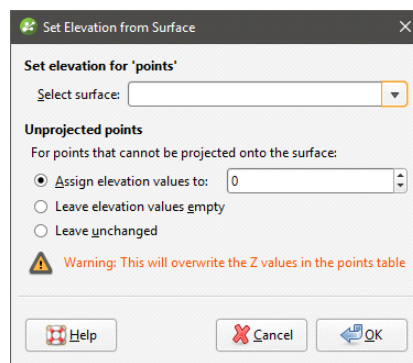

Select from the surfaces available in the project.

Next, select how unprojected points should be handled. There are three options:

- **Assign elevation values to** sets the z values to a fixed elevation for all unprojected points.
- **Leave elevation values empty** clears the z values for all unprojected points.
- **Leave unchanged** makes no changes to the z values for unprojected points.

Click **OK** to set elevation values.

Evaluating Points Data

Once points data has been imported to the project, it can be modified and evaluated against geological and numeric models, as described in [Evaluations](#).

In the case of geological models, you can also combine two or more models to evaluate the points data and set the priority used for evaluation. To do this, click on the **Combined Evaluation** button in the **Select Models To Evaluate** window. In the window that appears, select the evaluations to combined, then set their priority. Click **OK** to create the combined

evaluation, then click **OK** in the **Select Models To Evaluate** window. The combined evaluation will be available from the colour list.

To delete a combined evaluation, click on the **Delete Combined** button in the **Select Models To Evaluate** window.

Displaying Points

Points data can be displayed using a single flat colour, using a colour gradient or using the points values. You can also import a colourmap, which is described in [Colour Options](#).

As with wells, points data can be displayed as flat points or as spheres. When **Make points solid** button (🔴) is enabled for points data, the data points are displayed as spheres. Here, the values are displayed as flat points:

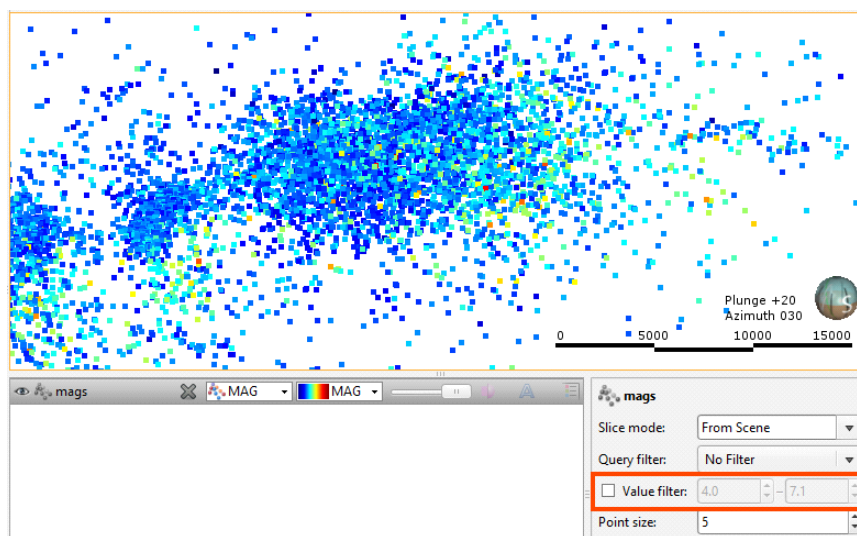

You can restrict the range of values displayed using the **Value filter** in the properties panel.

When using the spheres option (🔴), the points can be displayed using the values. To do this, the **Radius values** list displays the columns available:

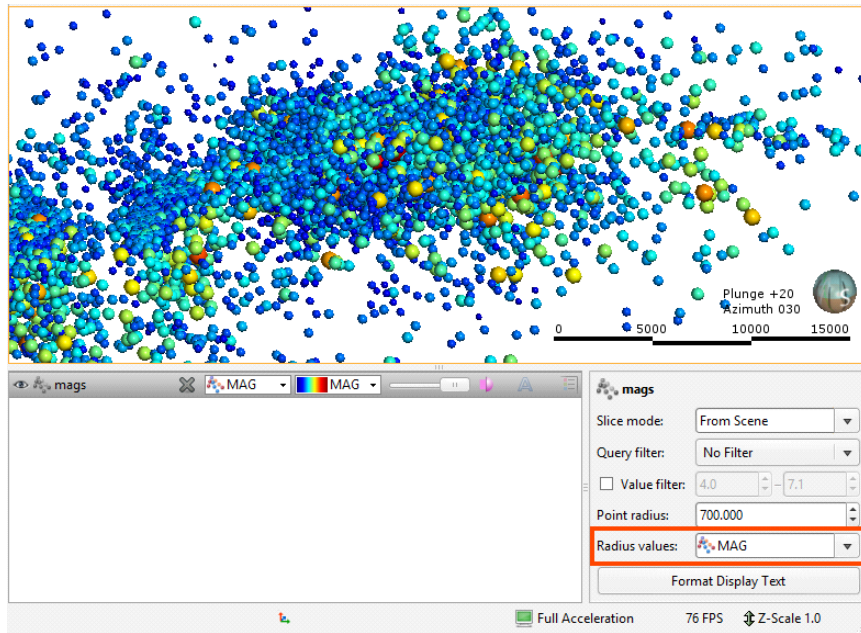

Select the column that will be used to determine the point size.

The **Point radius** control then determines the maximum point size displayed in the scene.

Viewing Points Table Statistics

To view statistics on points data tables, right-click on a points table and select **Statistics**. The following options are available:

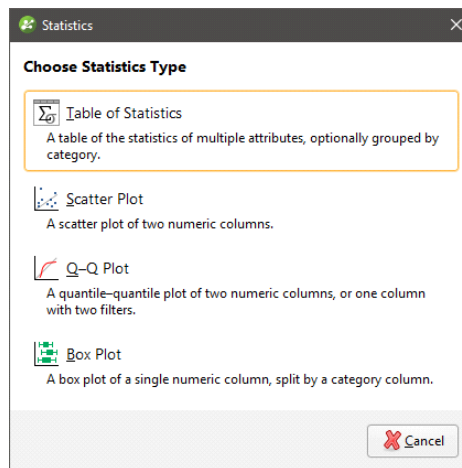

See the [Analysing Data](#) topic for more information on each option:

- [Table of Statistics](#)
- [Scatter Plots](#)
- [Q-Q Plots](#)
- [Box Plots](#)

Exporting Points Data

To export points data, right-click on the points data object in the project tree and select **Export**. For many points objects, you will be prompted to select which rows to include. Points data can be exported in the following formats:

- CSV Files (*.csv)
- DXF Files (11/12 [AC1009]) (*.dxf)
- Drawing Files (2013/LT2013) (*.dwg)
- Bentley Drawing Files (v8) (*.dgn)

Additional export options are available for some types of points, which are described below.

Once you have selected how you wish to export the data, click **Export**. You will be prompted for a filename and location.

Exporting Intrusion Values

Intrusion values can be extracted from well data as described in [Extracting Intrusion Values from Well Data](#).

There are two options for exporting intrusion values:

- Export only the contact points. To do this, right-click on the intrusion values object and select **Export**. If you choose this option, you can export the points in CSV format (*.csv), DXF format (*.dxf) or DWG format (*.dwg).
- Export all the points used in creating an intrusion. To do this, right-click on the intrusion values object and select **Export Volume Points**. If you choose this option, you can only export the points in CSV format (*.csv).

In both cases, you will be prompted for a filename and location.

Exporting Interval Midpoints

Interval midpoints can be extracted from well data, which is described in [Extracting Interval Midpoints from Well Data](#). You can also export midpoints directly from an RBF interpolant, which is described in [Exporting Numeric Model Midpoints](#).

To export interval midpoints, right-click on the points data object in the project tree and select **Export**. Interval midpoints can be exported in the following formats:

- CSV text file (*.csv)
- Snowden Supervisor CSV file (*.csv)
- Isatis 3D points file (*.asc)

The values exported are the midpoints of each segment, the X-Y-Z values and the hole ID. The Snowden Supervisor and Isatis 3D points formats also include the interval length.

In each case, you will be prompted for a filename and location.

Extracting Points from Well Data

This topic describes extracting different types of points from imported well data. It is divided into:

- [Extracting Contact Points from Well Data](#)
- [Extracting Intrusion Values from Well Data](#)
- [Extracting Interval Midpoints from Well Data](#)

If you wish to save and export points data with X-Y-Z information, use these options, then right-click on the data object to export the data as described in [Exporting Points Data](#).

Extracting Contact Points from Well Data

Contact points define the boundary between two lithology layers. You can extract contact points from interval tables to create a new points object in the **Points** folder. The values extracted are the x-y-z values of the contact points.

To extract contact points from an interval table, right-click on the **Points** folder and select **New Contact Points**. A window will appear listing the lithology and category columns available in the project:

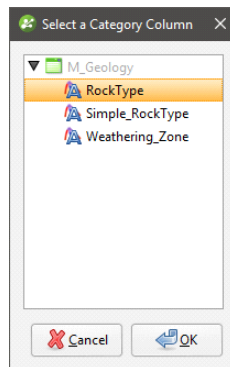

Select the required column and click **OK**.

Next, the **New Contact Points** window will appear:

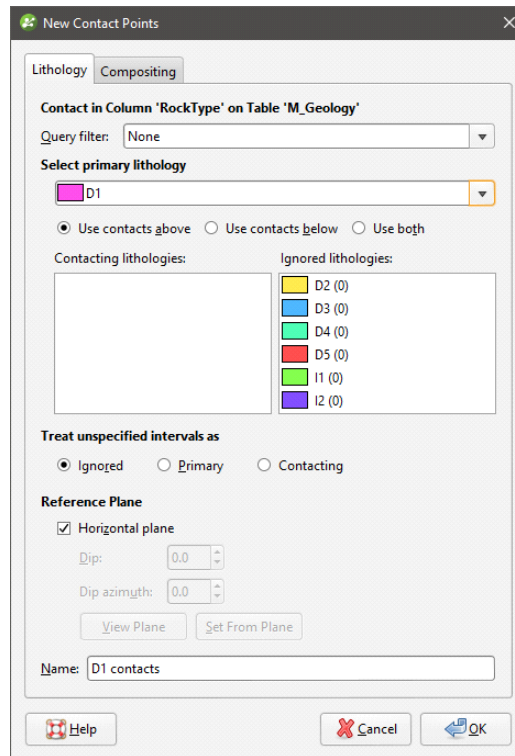

Select the lithology required from the **Select primary lithology** list, then select the adjacent lithologies you wish to extract in the **Contacting lithologies** list.

Unspecified intervals are intervals that have no data. By default, unspecified intervals are ignored when creating new contact points, but you can also treat them as the primary lithology or as contacting lithologies.

For complex geologies, the up and down directions for the surface may not be clear. If this is the case, untick the **Horizontal Plane** box. A reference plane will appear in the scene, with the up-facing surface labelled A and the downward-facing surface labelled B:

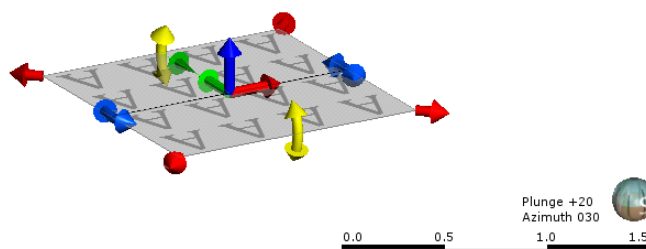

Controlling the position of the reference plane is similar to controlling the position of the moving plane:

- Use the handles in the scene window to move the plane.
- Set the **Dip** and **Dip Azimuth** values in the **New Contact Points** window. The reference plane will be updated in the scene.

Once the reference plane is correctly oriented, click the **Set From Plane** button.

A reference plane set for contact points in the **Points** folder will be applied wherever the contact points are used.

Click **OK** to create the points, which will appear in the project tree under the **Points** folder. To edit the points, double-click on them.

Extracted contact points can be exported as described in [Exporting Points Data](#).

Extracting Intrusion Values from Well Data

You can extract intrusion points from interval tables to create a new points object in the **Points** folder.

To extract intrusion values from an interval table, right-click on the **Points** folder and select **New Intrusion Values**. A window will appear listing the lithology and category columns available in the project:

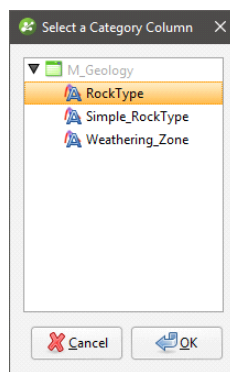

Select the required column and click **OK**.

Next, the **New Intrusion** window will appear:

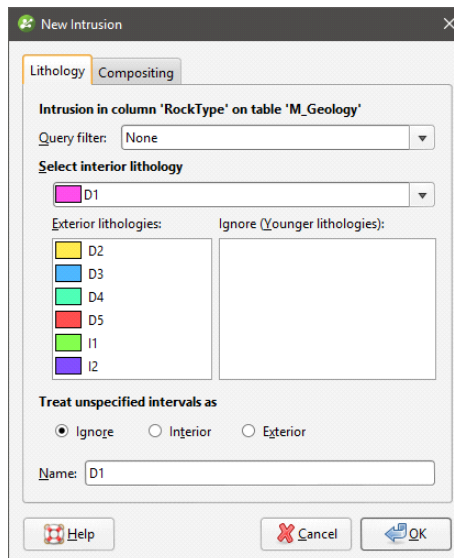

Select the intrusion lithology, then move any younger lithologies to the **Ignore** list.

Unspecified intervals are intervals that have no data. By default, unspecified intervals are ignored when extracting intrusion values, but you can also treat them as the interior lithology or as exterior lithologies.

The settings in the **Compositing** tab are described in [Category Composites](#).

Click **OK** to create the new points object, which will appear in the project tree under the **Points** folder. To edit the points, double-click on the points object (🔗) in the project tree. See [Intrusion Point Generation Parameters](#) below.

When you view the intrusion points in the scene, you can display only the contact points or all the points used determining the extrusion values. To display all points, click on the points object in the shape list and tick the box for **Show volume points**:

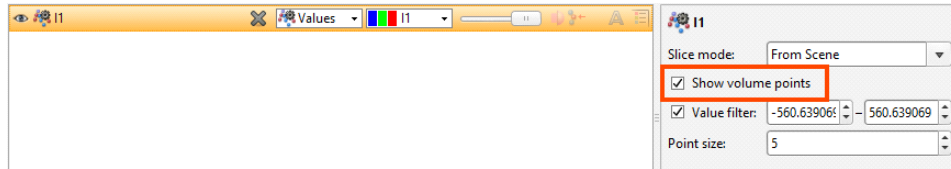

Extracted intrusion points and values can be exported as described in [Exporting Points Data](#).

Intrusion Point Generation Parameters

To change the way intrusion values are generated, double-click on the points object (🔗) in the project tree:

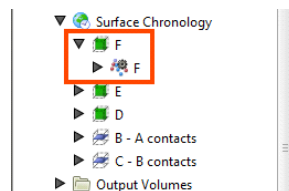

The **Edit Intrusion** window will appear, displaying the **Point Generation** tab.

Here, the surface and volume points are displayed to show the effects of the **Surface offset distance** and **Background fill spacing** parameters:

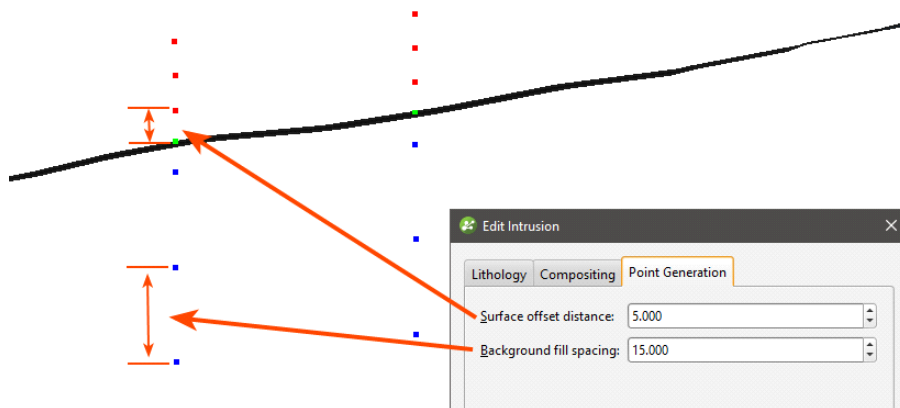

The **Surface offset distance** parameter sets the top and bottom ends of the interval and affects how a surface behaves when it approaches a contact point. A smaller distance restricts the angles that an approaching surface can take. Another factor that affects the angles a surface will take is whether or not a trend has been applied to the surface.

The **Background Fill Spacing** parameter determines the approximate length of segments in the remaining intervals. If the remaining interval is not a multiple of the **Background Fill Spacing** value, Leapfrog Geothermal will automatically adjust the spacing to an appropriate value. A smaller value for **Background Fill Spacing** means higher resolution and, therefore, slightly smoother surfaces. However, computation can take longer.

Extracting Interval Midpoints from Well Data

You can extract interval midpoints from raw or composited numeric and category tables to create a new points object in the **Points** folder. The extracted points will be dynamically linked to the original well segments and can be evaluated against other data in the project. The values extracted are the midpoints of each segment, the X-Y-Z values and the hole ID.

If you are exporting points data for use in Snowden Supervisor, use this option for extracting points from well data. If you wish to export midpoints from an interpolant, see [Exporting Numeric Model Midpoints](#).

To extract midpoints from an interval table, right-click on the **Points** folder and select **New Interval Mid Points**. In the window that appears, select the required **Source table**, then select which data columns to use:

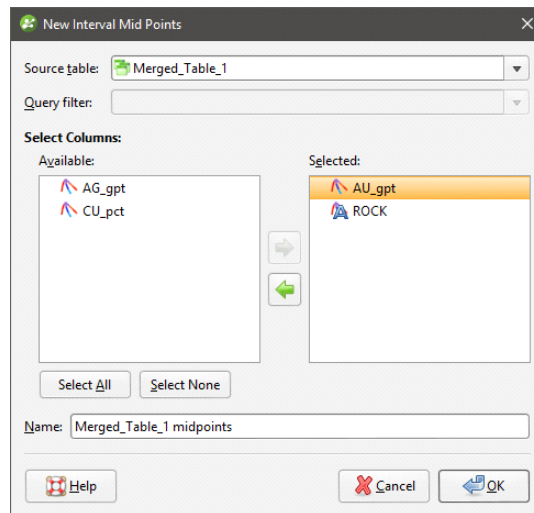

Apply a query filter, if required, then click **OK**. The new points object will appear in the project tree under the **Points** folder. To edit the points, double-click on the points object (🔗) in the project tree.

Changes made to the source data table, such as changes to compositing parameters or special values rules, will be reflected in the extracted points object.

Extracted interval midpoints can be exported as described in [Exporting Points Data](#).

Creating Guide Points

Guide points can be created from any category point data in the project and added to surfaces. Category data that can be used to create guide points includes:

- Downhole category point data
- LAS points
- Category data on imported points
- Interval midpoints

Guide points are classified into interior or exterior, and each guide point is assigned a distance value that is the distance to the nearest point on the opposite side. Interior values are positive and exterior values are negative.

Guide points are a good way of using blasthole data to control surfaces: create the guide points from the downhole points, then add the guide points to the surface.

To create guide points, right-click on the **Points** folder and select **New Guide Points**. A window will appear listing the category columns available in the project:

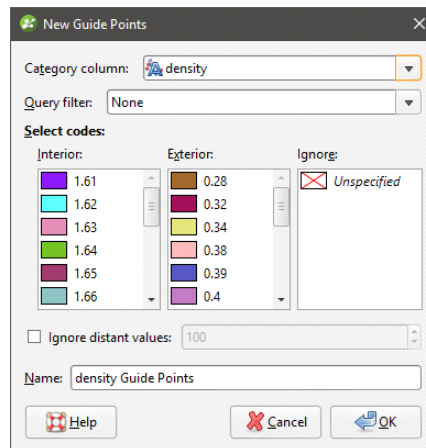

Select the categories to assign to **Interior** (the positive side) and **Exterior** (the negative side).

You can also filter out distant values by ticking the **Ignore distant values** box and entering a value. Often distant values have little effect on a surface and filtering out these values can improve processing time.

Click **OK**. The guide points will appear in the project tree under the **Points** folder. To edit the points, double-click on them.

Guide points can be exported as described in [Exporting Points Data](#).

Grids of Points

You can create a grid of points that can be evaluated against geological and numeric models and exported for use in other modelling packages. This topic describes creating and working with grids of points. It is divided into:

- [Creating a Grid of Points](#)
- [Evaluating a Grid of Points](#)
- [Statistics for a Grid of Points](#)
- [Exporting a Grid of Points](#)

Creating a Grid of Points

You can create a grid of points that can be evaluated against geological models and interpolants and exported for use in other modelling packages.

To create a grid of points, right-click on the **Points** folder and select **New Grid of Points**. The **New Grid of Points** window will appear, together with controls in the scene that will help in setting the grid's boundary:

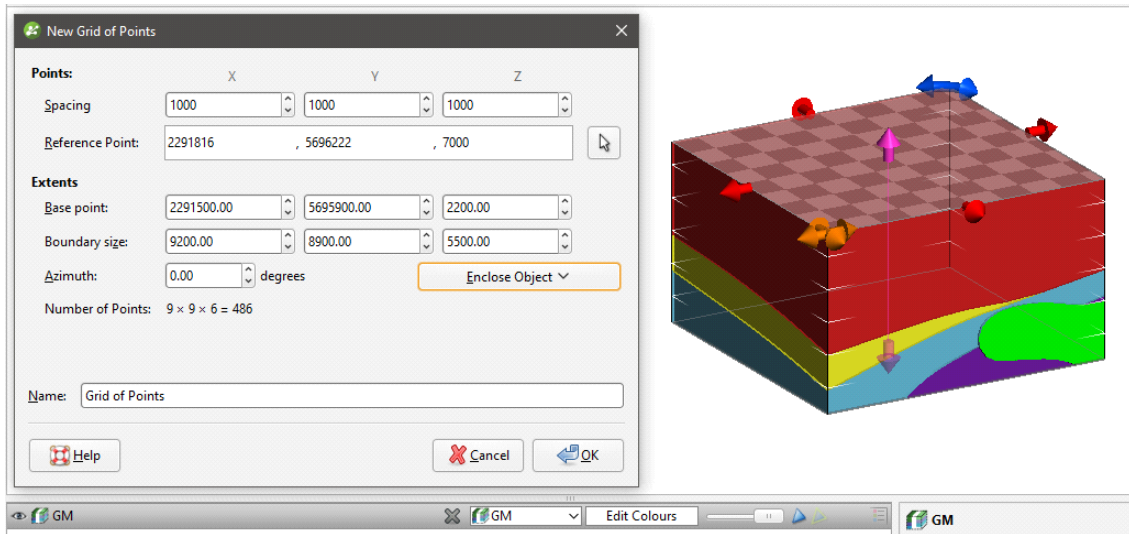

Set the **Spacing** and **Reference Point**, which will control the number of points in the grid. You can set the **Reference Point** by clicking in the scene. To do this, first click on the **Select** button () for the **Reference Point**, then click in the scene. The coordinates in the scene will be copied to the **New Grid of Points** window.

For the **Extents**, you can select an object from the **Enclose Object** list to use the extents of another object in setting the grid's extents. You can also change the size and position of the grid using the controls in the scene:

- The orange handle adjusts the **Base Point**.
- The red and pink handles adjust the **Boundary Size**.
- The blue handles adjust the **Azimuth**.

If you have set the extents from another object and then rotated the grid, you will need to reset the extents by selecting the object again from the **Enclose Object** list.

The **Number of Points** in the grid will be updated as you change settings in the **New Grid of Points** window. If the number of points will be very large, rendering of the grid in the scene will be disabled.

You will be able to change the settings in this window once the grid has been created.

Click **OK** to create the grid, which will appear in the **Points** folder. Double-click on the grid to change its settings.

Evaluating a Grid of Points

Once you have created the grid, you will be able to evaluate it against geological models, interpolants and distance functions in the project. Right-click on the grid and select **Evaluations**, then select from the models available. The evaluations will be shown in the project tree as part of the grid:

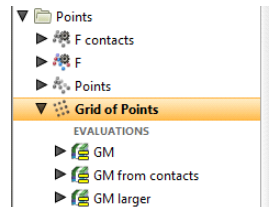

Evaluations will be exported with the grid. See [Exporting a Grid of Points](#) below.

Statistics for a Grid of Points

To view statistics on a grid of points, right-click on the grid and select **Statistics**.

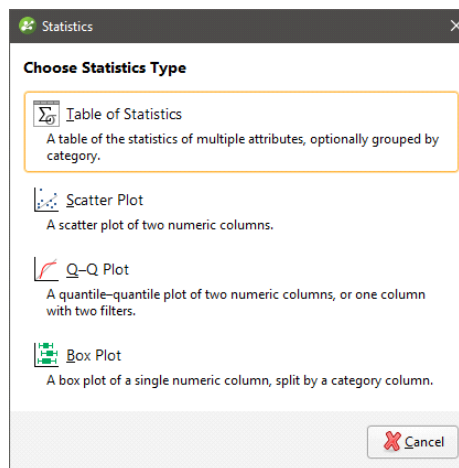

See the [Analysing Data](#) topic for more information on each option:

- [Table of Statistics](#)
- [Scatter Plots](#)
- [Q-Q Plots](#)
- [Box Plots](#)

Exporting a Grid of Points

You can export a grid of points in the following formats:

- CSV file (*.csv)
- GSLIB Data file (*.dat)

- Surpac Block Model file (*.mdl)
- Isatis Block Model file (*.asc)
- Geo 3D Point Data file (*.pl3, *.ara)

For CSV, Surpac Block Model and Isatis format files, all evaluations on the grid of points will be exported as part of the file. For all other file types, only numeric evaluations will be exported.

To export a grid of points, right-click on it in the project tree and select **Export**. Select the format required, enter a filename and location, then click **Save**.

Categorising Points

When you wish to select a small portion of points and you don't have suitable parameters to use a query filter, you can select points in the scene and assign them to categories. This adds a new column to the points object, preserving the original data.

To start categorising points, right-click on the points object (☰) in the project tree and select **New Category Selection**.

The **New Category Selection** window will appear:

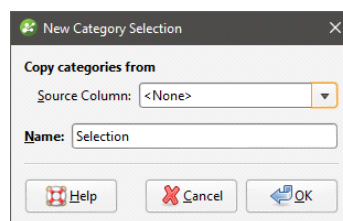

If you select an existing column as the **Source Column**, you can assign selected points to the existing categories or create new categories. If you select **<None>** for the **Source Column**, you will have to define each category manually.

When you click **OK**, the points object will be added to the scene, along with a set of tools for selecting points. To select points, click on the **Select Points** button (📍) and click the **Add Points** button (📏). In the scene, draw a line across each point you wish to select:

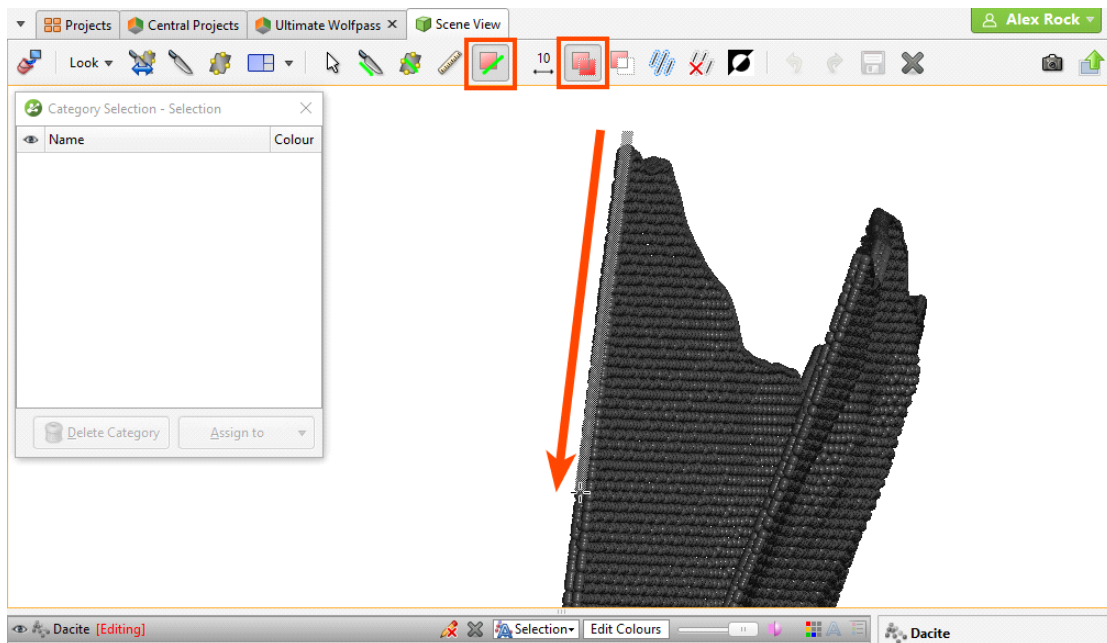

Selected points are highlighted in the scene. If you accidentally select the wrong point, either:

- Click the **Remove Points** button (🗑️) and draw across the point once again.
- Hold the **Ctrl** key while drawing across the point.

You can also:

- Select all visible points by clicking on the **Select All** button (👤) or by pressing Ctrl+A.
- Clear all selected points by clicking on the **Clear Selection** button (🗑️) or by pressing Ctrl+Shift+A.
- Swap the selected points for the unselected points by clicking on the **Invert Selection** button (🔄) or by pressing Ctrl+I.

To change the width of the line used to select points, click on the **Change Line Width** button (📏) and enter a new value. You can keep the **Set Line Width** window open while you select points so you can change the line width as required.

When you have selected at least one point, click on the **Assign to** button, then select **Create New Lithology**:

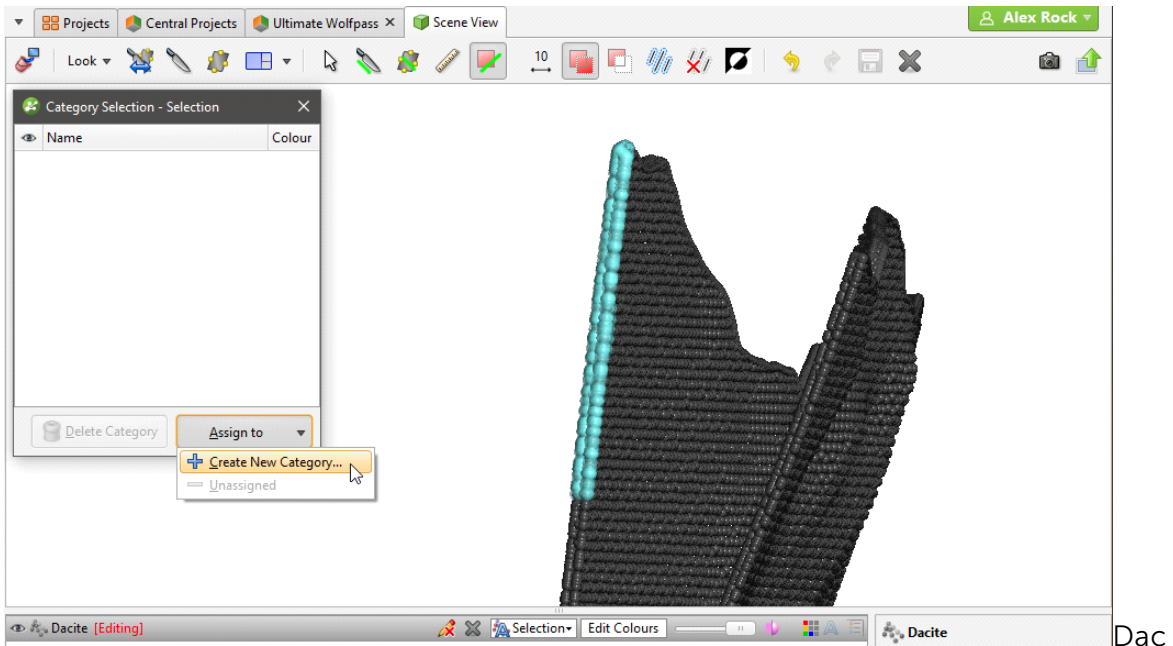

Enter a **Name** for the new category, then click **OK**.

The new category will be created and the scene updated to reflect the changes:

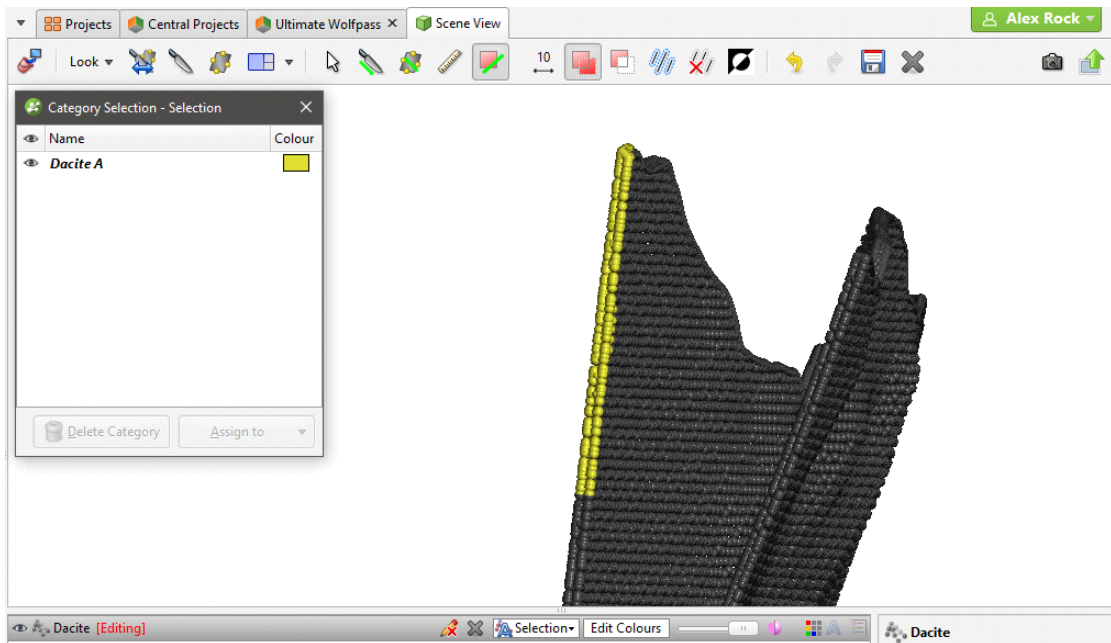

Once you have created a new category, you can add to it by selecting further points, then selecting the category from the **Assign to** list.

When you are finished, click the **Save** button (floppy disk icon) and close the **Category Selection** window. The new category column will appear in the project tree as an additional column in the points table. Select the new column from the shape list to display it.

Geophysical Data

This topic describes the types of geophysical data Leapfrog Geothermal supports. It is divided into:

- [Geophysical Points Data](#)
 - [3D Geophysical Points](#)
 - [ASEG_DFN Files](#)
 - [2D Points](#)
 - [Visualising Geophysical Point Data](#)
- [Geophysical Grids](#)
 - [2D Grids](#)
 - [Gocad Models](#)
 - [UBC Grids](#)
 - [Importing a UBC Grid](#)
 - [Evaluating UBC Grids](#)
 - [Mapping Category Evaluations](#)
 - [Exporting a UBC Grid](#)
 - [Magnetotelluric Resistivity Files](#)
 - [Exporting Geophysical Grids to CSV](#)

Geophysical Points Data

Leapfrog Geothermal supports the import of 3D geophysical points, ASEG_DFN files and 2D points.

3D Geophysical Points

3D geophysical points should be imported into the **Geophysical Data** folder rather than into the **Points** folder.

Leapfrog Geothermal imports 3D geophysical points in CSV format.

To import geophysical 3D points, right-click on the **Geophysical Data** folder and select **Import Geophysical Points**. Leapfrog Geothermal will ask you to specify the file location. Click **Open** to import the file. Leapfrog Geothermal will display the data and you can select which columns to import.

Leapfrog Geothermal expects **East (X)**, **North (Y)** and **Elev (Z)** columns.

Click **Finish** to import the file, which will appear in the **Geophysical Data** folder.

Geophysical point data is not checked for duplicates.

You can visualise time-dependent 3D point data in the scene, which is described in [Visualising Geophysical Point Data](#) below.

ASEG_DFN Files

Leapfrog Geothermal imports ASEG_DFN points in *.dfn format. To import an ASEG_DFN file, right-click on the **Geophysical Data** folder and select **Import ASEG_DFN**. Leapfrog Geothermal will ask you to specify the file location. Click **Open** to import the file. In the window that appears, enter a name for the file, then click **OK**. Next set the X, Y and Z coordinates and click **OK**. If you select no column for the Z coordinates, all Z values will be set to zero.

The file will appear in the **Geophysical Data** folder.

2D Points

Leapfrog Geothermal imports the following formats:

- CSV files (*.csv)
- ASCII text files (*.asc)
- Plain Text Files (*.txt)
- Data Files (*.dat)

To import geophysical 2D points, right-click on the **Geophysical Data** folder and select **Import 2D Points**. Leapfrog Geothermal will ask you to specify the file location. Click **Open** to import the file. Leapfrog Geothermal will display the data and you can select which columns to import.

Leapfrog Geothermal expects **East (X)** and **North (Y)** columns.

Click **Finish** to import the file, which will appear in the **Geophysical Data** folder.

As for 2D grid data, the elevation of 2D geophysical points data can be set to a constant depth or draped on an existing mesh, as described in [Setting Elevation for Points](#).

2D geophysical points data can be reloaded. See [Reloading Points Data](#).

Visualising Geophysical Point Data

Geophysical 3D point data can be filtered in the scene by a time or another numeric column, e.g. a time or date column. This enables micro-seismic data to be visualised over time. To do this, click on the points table in the shape list, then select a time or date column as the **Value filter** in the properties panel:

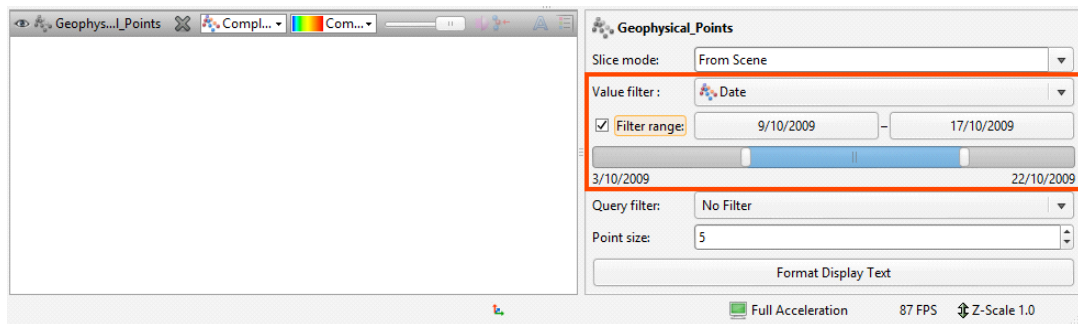

Next tick **Filter range** and either click the date buttons to set the upper and lower limits or use buttons on either end of the slider.

Options for the slider are:

- Drag the slider to see how the data changes over time.
- Double-click on the slider to see the full range of data. The slider will turn purple.
- Right double-click on the slider to return to the restricted range. The slider will be blue.

Geophysical Grids

Leapfrog Geothermal imports 2D grids, Gocad models, UBC grids and magnetotelluric resistivity (OUT) files.

2D Grids

Leapfrog Geothermal imports 2D grids in the following formats to both the **Geophysical Data** folder and the **GIS Data, Maps and Photos** folder:

- Arc/Info ASCII Grid (*.asc, *.txt)
- Arco/Info Binary Grid (*.adf)
- Digital Elevation Model (*.dem)
- Intergraph ERDAS ER Mapper 2D Grid (*.ers)
- ESRI .hdr Labelled Image (*.img, *.bil)
- SRTM .hgt (*.hgt)
- Surfer ASCII or Binary Grid (*.grd)

If you have geophysical grids in one of these formats, import them into the **Geophysical Data** folder;

See [2D Grids](#) for more information on importing 2D grids.

Gocad Models

To import a Gocad model, right-click on the **Geophysical Data** folder and select **Import Gocad Model**. Leapfrog Geothermal will ask you to specify the file location. Click **Open** to import the file.

In the window that appears, set the **Subsample Rate** and enter a **Name** for the model. Click **OK** to import the model, which will appear under the **Geophysical Data** folder.

You can then evaluate geological models, interpolants and distance functions in the project on the model. In the case of geological models, you can also combine two or more models to evaluate on the model. To evaluate a model, right-click on the model object in the project tree and select **Evaluations**. See [Evaluations](#) for more information.

A Gocad model can be exported as points to a CSV file. This is described in [Exporting Geophysical Grids to CSV](#) below.

UBC Grids

Leapfrog Geothermal imports UBC grids in *.msh format, together with numeric values in properties files in *.gra, *.sus, *.mag and *.den formats. UBC grids can be evaluated against geological and numeric models, which can then be exported with the grid.

Importing a UBC Grid

To import a UBC grid, right-click on the **Geophysical Data** folder and select **Import UBC Model**. In the window that appears, click **Browse** to locate the file to be imported. Click **Add** to add any properties file, although these are not required.

For any properties file, click the **Inactive Value** field to mark cells as inactive. Doing so does not change the data but ensures that cells with the inactive value can be hidden when the grid is displayed in the scene. If you do not set this value when importing the grid, you can set it later by double-clicking on the grid in the project tree.

Click **Import**. The grid will appear in the **Geophysical Data** folder.

Evaluating UBC Grids

UBC grids can be evaluated against geological and numeric models as described in [Evaluations](#). However, UBC grids cannot be evaluated against fault blocks and mutli-domained RBF interpolants, although they can be evaluated against the parent geological model and the parent numeric model.

Mapping Category Evaluations

When a UBC grid is exported with a category evaluation, category data is mapped to an editable numeric value. You can edit this by double-clicking on the grid in the project tree, then clicking on the **Export Mappings** tab:

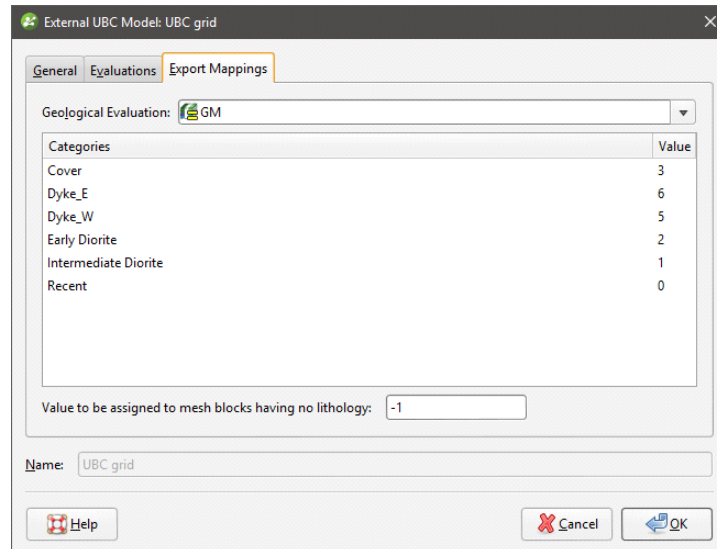

Change the numeric value assigned to each lithology, if required. You can also change the value assigned to blocks that have no lithology.

The **Export Mappings** tab does not appear for UBC grids that have no geological model evaluations.

Exporting a UBC Grid

To export a UBC grid, right-click on it in the project tree and select **Export**. Select the evaluations to export with the grid, then select a folder. Click **OK** to export the grid.

A UBC grid can also be exported as points to a CSV file. This is described in [Exporting Geophysical Grids to CSV](#) below.

Magnetotelluric Resistivity Files

Leapfrog Geothermal imports magnetotelluric resistivity (OUT) files in *.out, *.out.gz and *.mod formats. To import an OUT file, right-click on the **Geophysical Data** folder and select **Import Magnetotelluric Resistivity Model**. Leapfrog Geothermal will ask you to specify the file location. Click **Open** to import the file. In the window that appears, set the options required, then click **OK** to import the model. The model will appear under the **Geophysical Data** folder.

You can then evaluate any geological model, interpolant or distance function in the project on the model. In the case of geological models, you can also combine two or more models to evaluate on the model. To evaluate a geological model, interpolant or distance function, right-

click on the model object in the project tree and select **Evaluations**. See [Evaluations](#) for more information.

A magnetotelluric resistivity grid can be exported as points to a CSV file. This is described in [Exporting Geophysical Grids to CSV](#) below.

Exporting Geophysical Grids to CSV

Geophysical grids in Gocad, UBC and magnetotelluric resistivity format can be exported as points to a CSV file. To do this, right-click on the grid and select **Export as Points**. You will then be prompted to select a file name and location. Once you have clicked **Save**, select the CSV export options for null values and numeric precision, then click **OK**.

The CSV file will contain:

- X, Y and Z columns, which represent the centre of each grid block
- I, J and K columns, which is the grid block index. I is in the range (1,NI), J is in the range (1,NJ) and K is in the range (1,NK), where NI,NJ,NK are the grid dimensions.
- One or more data columns

Structural Data

In Leapfrog Geothermal, you can create and edit planar structural data tables directly or from other objects in the project. Structural data can also be used to create and edit many surfaces. Downhole planar structural data and lineations can also be imported, although structural data imported in this way cannot be edited.

This topic describes how to work with structural data in Leapfrog Geothermal. It covers:

- [Creating New Planar Structural Data Tables](#)
- [Importing Planar Structural Data](#)
- [Importing Lineations](#)
- [Displaying Structural Data](#)
- [Viewing Statistics on Structural Data](#)
- [Assigning Structural Data to Categories](#)
- [Editing the Orientation of Planar Structural Data](#)
- [Declustering Planar Structural Data](#)
- [Setting Elevation for Structural Data](#)
- [Estimating Planar Structural Data](#)

See [Stereonets](#) and [Form Interpolants](#) for information on tools for analysing structural data.

Leapfrog Geothermal calculates strike using the American right-hand rule; when looking in the strike direction, the plane should dip to the right.

Creating New Planar Structural Data Tables

There are two ways to create a new planar structural data table in Leapfrog Geothermal:

- Create a new table as part of creating or editing another object. See [Editing Surfaces with Structural Data](#).
- Create a new table using the **Structural Modelling** folder. Use this technique when, for example, you are creating structural data points from a map or image. Right-click on the **Structural Modelling** folder and select **New Planar Structural Data**. In the window that appears, enter a name for the new table and click **OK**.

Before creating the new data table, add the map, image or data object you wish to work from to the scene and orient the scene for drawing the new data points.

When a new structural data table is created, it will be added to the scene. The **Planar Structural Data** window will open, together with a set of tools for adding structural data points:

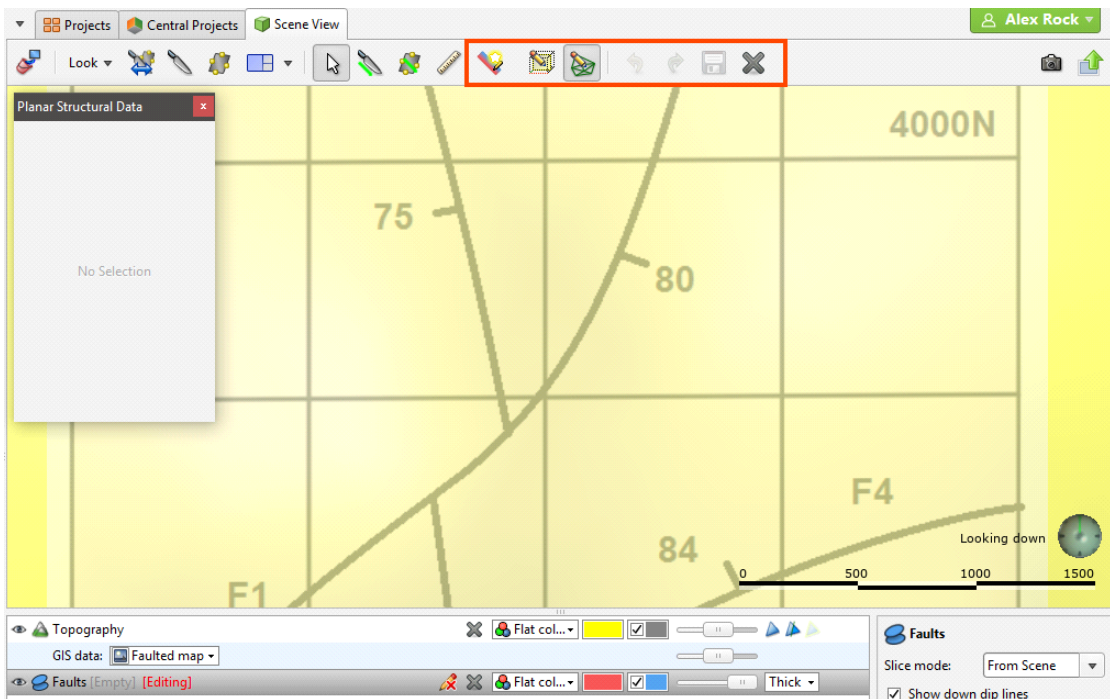

Click on the **New Structural Data Point** button (📍) and click and drag along the strike line in the scene to add a new data point:

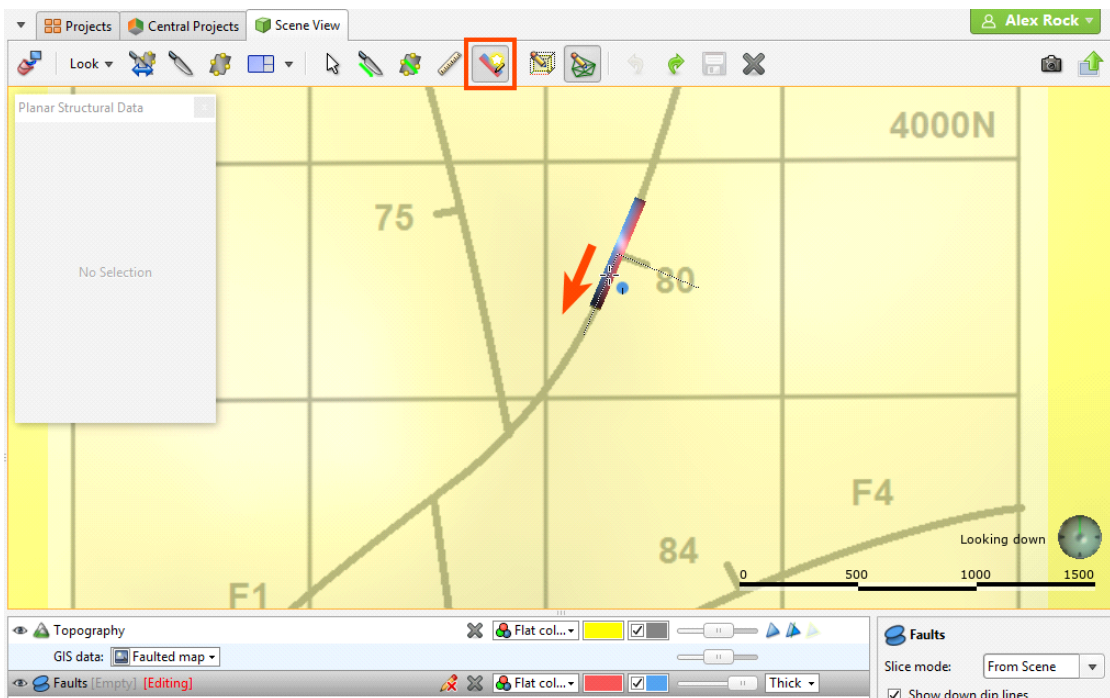

You can adjust the data point using the controls in the **Planar Structural Data** window:

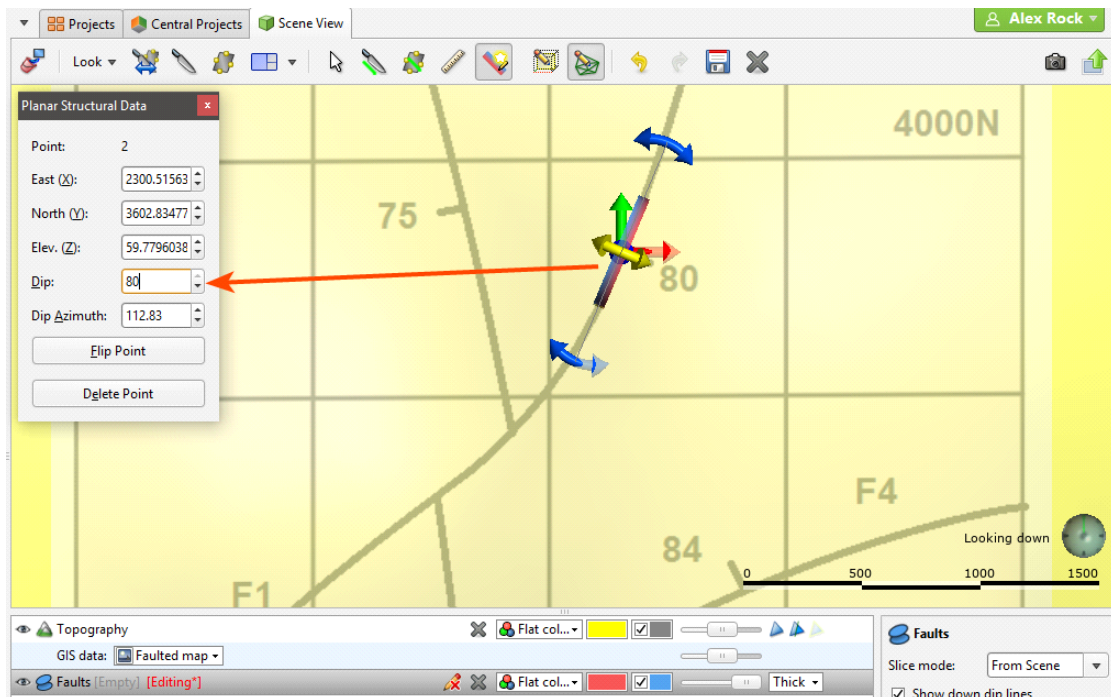

Importing Planar Structural Data

Leapfrog Geothermal supports planar structural measurements in .csv or text formats. This topic describes importing structural data tables that include location information. Downhole structural data can also be imported, as described in [Importing Downhole Structural Data](#).

Structural data containing location information can be imported from:

- Files stored on your computer or a network location. Right-click on the **Structural Modelling** folder and select **Import Planar Structural Data**. You will be prompted to select a file.
- From any database that runs an ODBC interface. Right-click on the **Structural Modelling** folder and select **Import Planar Structural Data via ODBC**. See [Selecting the ODBC Data Source](#) below.

For each of these options, once the data source is selected, the process of importing the data is the same. Leapfrog Geothermal will display the data and you can select which columns to import:

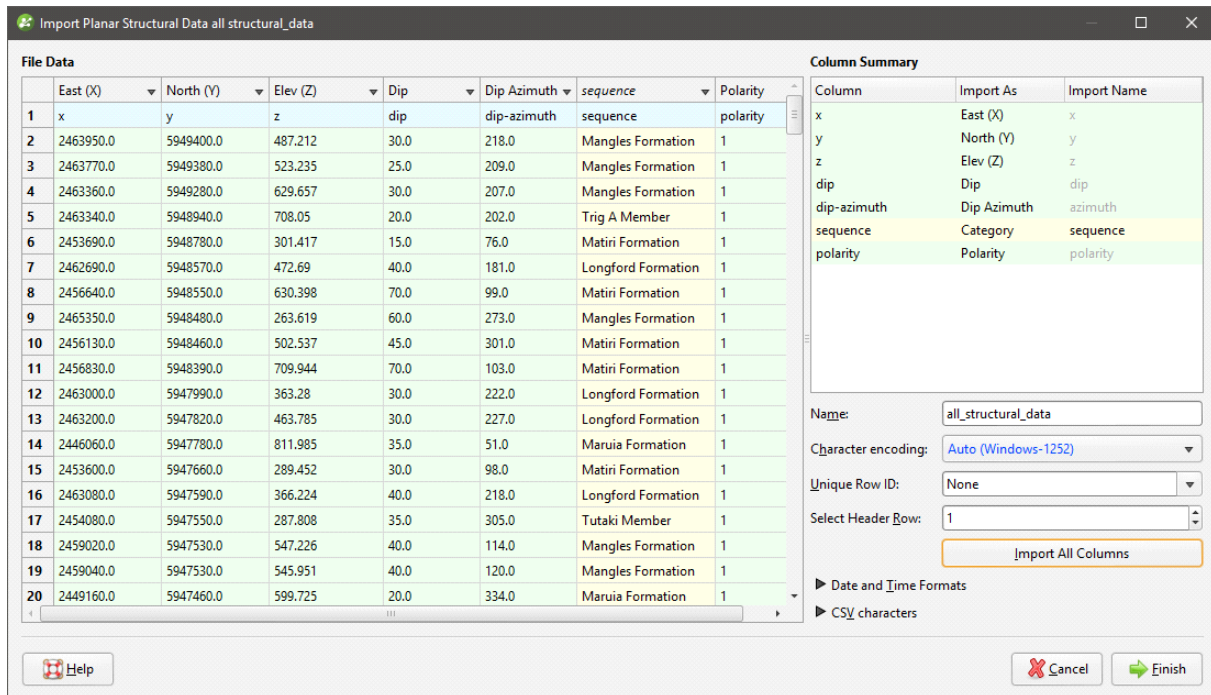

Leapfrog Geothermal expects **East (X)**, **North (Y)**, **Elev (Z)**, **Dip** and **Dip Azimuth** columns. The **Polarity** column is optional. The **Base Category** column can be used for filtering data once it has been imported.

Click **Finish** to import the data. The structural measurements will appear in the **Structural Modelling** folder.

Once the data has been imported, you can reload and append the data and add columns to the data in a similar manner to well data. See [Appending Wells](#), [Reloading Well Data](#) and [Importing Columns](#) for more information.

Selecting the ODBC Data Source

When importing planar structural data from an ODBC database, you will need to specify the ODBC data source. Enter the information supplied by your database administrator and click **OK**.

Once the data source is selected, the import process is similar to that described above.

Importing Lineations

Lineations containing location information can be imported from files stored on your computer or a network location in .csv or text formats. To do this, right-click on the **Structural Modelling** folder and select **Import Lineations**. You will be prompted to select a file.

Leapfrog Geothermal expects **East (X)**, **North (Y)**, **Elev (Z)**, **Trend** and **Plunge** columns. The **Polarity** column is optional. The **Category** column can be used for filtering data once it has been imported.

Click **Finish** to import the data. The lineations will appear in the **Structural Modelling** folder. Once the data has been imported, you can reload and append the data and add columns to the data in a similar manner to well data. See [Appending Wells](#), [Reloading Well Data](#) and [Importing Columns](#) for more information.

Displaying Structural Data

Planar structural data is displayed as disks and lineations are displayed as cones. There are several ways to change how this data is displayed. In the scene below, planar structural data is displayed using the **Flat colour** option, with positive (red) and negative (blue) sides shown:

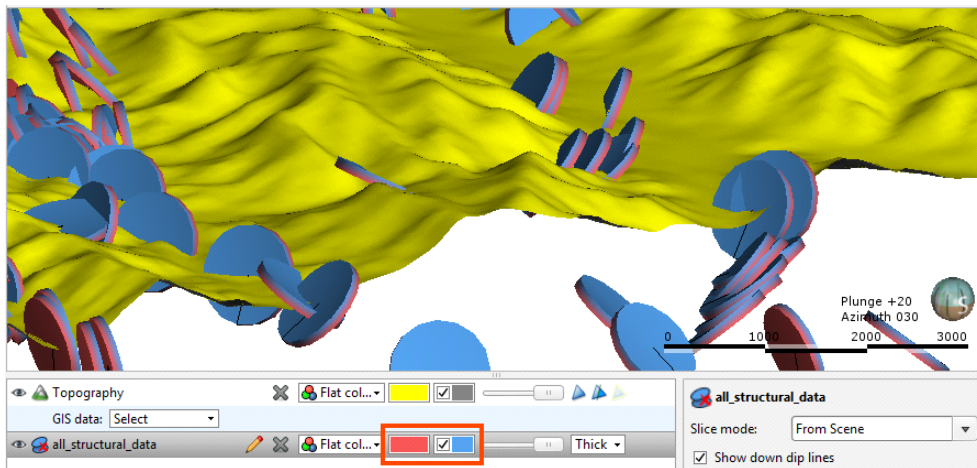

You can change the colours used to display the positive and negative sides using the controls in the shape list. You can also display the data points as **Thick** disks, **Flat** disks or as **Outlined flat** disks. You can change the **Disk radius** and the **Disk size** using the controls in the shape properties panel.

Another way of displaying planar structural data is to display the categories as different colours:

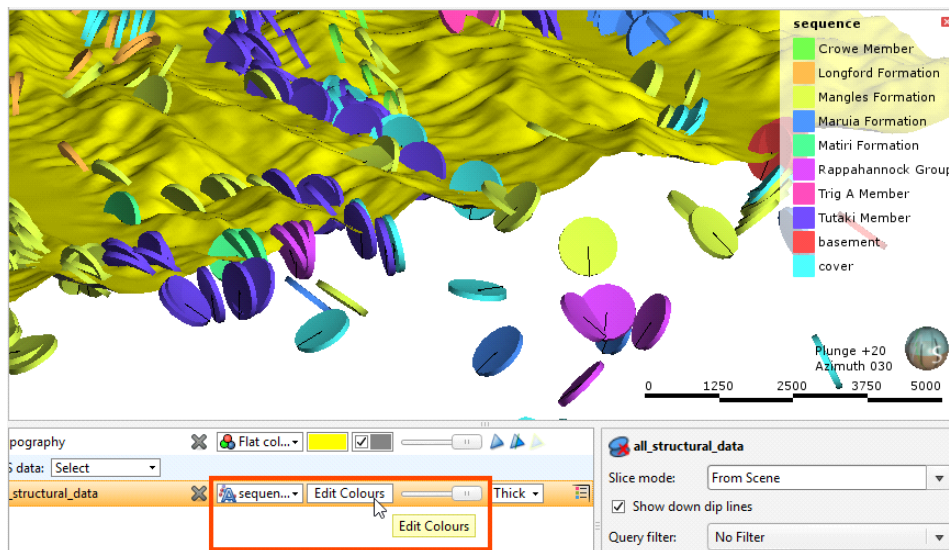

You can change the colours used to display the different categories by clicking on **Edit Colours** in the shape list. In the window that appears, click on the colour chip for each category and change it as described in [Single Colour Display](#).

To set multiple categories to a single colour, use the Shift or Ctrl keys to select the colour chips you wish to change, then click on one of the colour chips. The colour changes you make will be made to all selected categories.

The categories displayed can also be filtered by other columns in the data table, as described in [Filtering Data Using Values and Categories](#).

In the scene below, lineations are displayed using the **Flat colour** option in green:

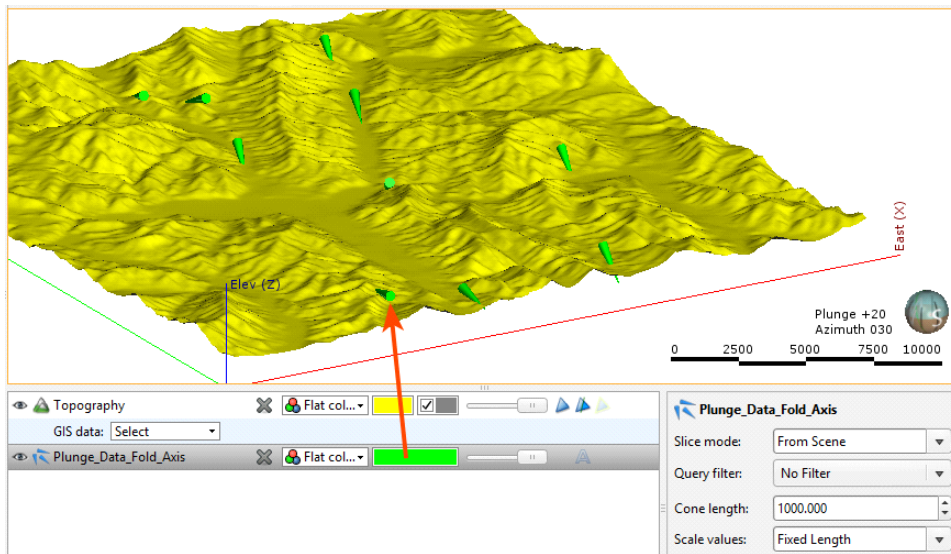

Click the colour chip to change the colour used to display the cones in the shape list or select one of the table's columns:

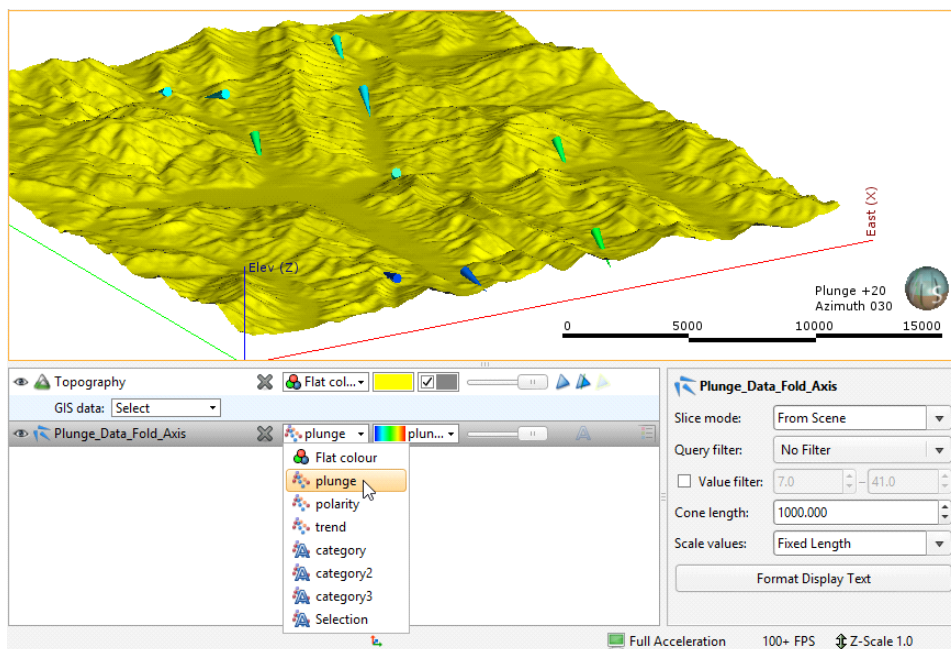

The length of the cones displayed in the scene is set in the properties panel. This can be a **Fixed Length**, defined by the **Cone length** setting, or it can be scaled using the values from one of the table's columns:

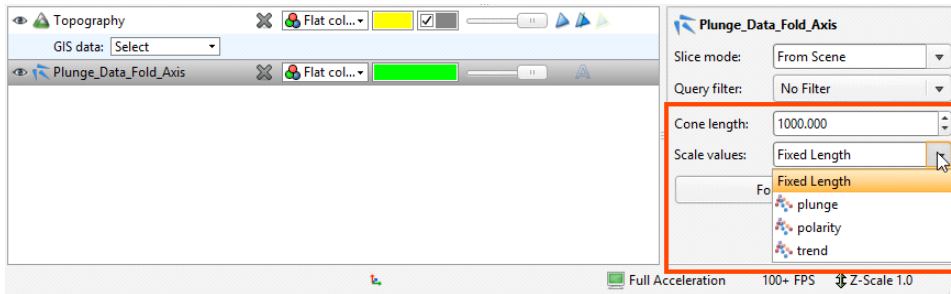

Another way of displaying lineations is to display the categories as different colours:

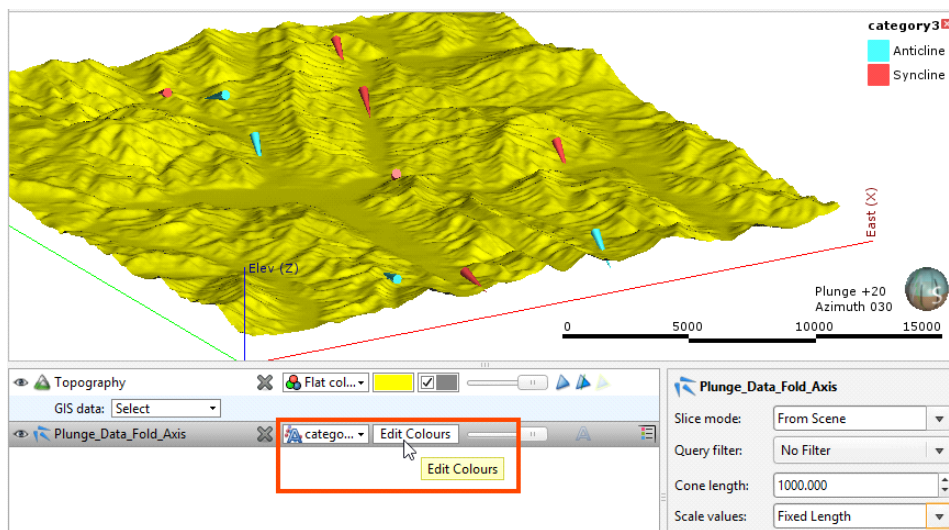

You can change the colours used to display the different categories by clicking on **Edit Colours** in the shape list. In the window that appears, click on the colour chip for each category and change it as described in [Single Colour Display](#).

To set multiple categories to a single colour, use the Shift or Ctrl keys to select the colour chips you wish to change, then click on one of the colour chips. The colour changes you make will be made to all selected categories.

The categories displayed can also be filtered by other columns in the data table, as described in [Filtering Data Using Values and Categories](#).

Viewing Statistics on Structural Data

To view statistics on structural data and lineations, right-click on a table and select **Statistics**. The following options are available:

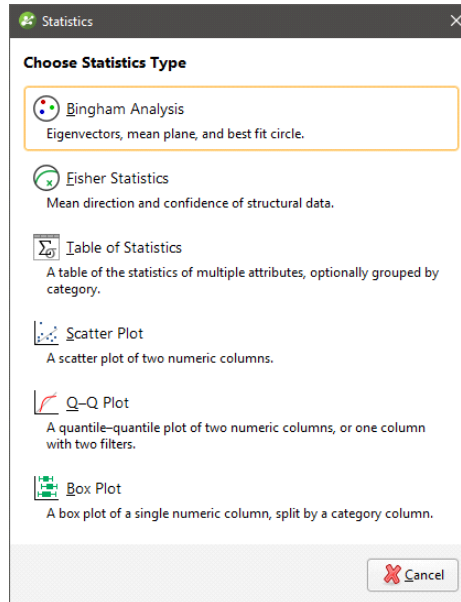

See the [Analysing Data](#) topic for more information on each option:

- [Table of Statistics](#)
- [Scatter Plots](#)
- [Q-Q Plots](#)
- [Box Plots](#)

Bingham Analysis

The **Bingham Analysis** option shows the value, trend and plunge for each of the eigenvectors, along with the Bingham mean plane and best-fit great circle:

Category	Count	Value	Trend	Plunge	Strike	Dip	Dip Az.
All Data	127	e1: 0.604 e2: 0.358 e3: 0.037	287.0 99.7 189.8	82.9 7.0 0.9	Mean plane: 17.0 Best fit great circle: 279.8	7.1 89.1	107.0 9.8
Bedding							
Base	52	e1: 0.900 e2: 0.077 e3: 0.023	39.2 186.7 276.7	86.5 2.9 1.9	Mean plane: 129.2 Best fit great circle: 6.7	3.5 88.1	219.2 96.7
Bedding1	37	e1: 0.613 e2: 0.387 e3: 0.000	277.2 97.6 7.3	23.8 66.2 0.1	Mean plane: 7.2 Best fit great circle: 97.3	66.2 89.9	97.2 187.3
Bedding2	26	e1: 0.633 e2: 0.367 e3: 0.000	107.0 287.0 197.0	12.5 77.5 0.0	Mean plane: 197.0 Best fit great circle: 287.0	77.5 90.0	287.0 17.0
Bedding3	12	e1: 0.828 e2: 0.160 e3: 0.011	270.6 104.2 4.4	31.6 57.6 6.2	Mean plane: 0.6 Best fit great circle: 94.4	58.4 83.8	90.6 184.4

You can select specific rows and copy them to the clipboard or copy all data to the clipboard. You can also export the data in *.csv format.

Fisher Statistics

The **Fisher Statistics** option shows the Fisher mean plane and confidence for the data in the selected table:

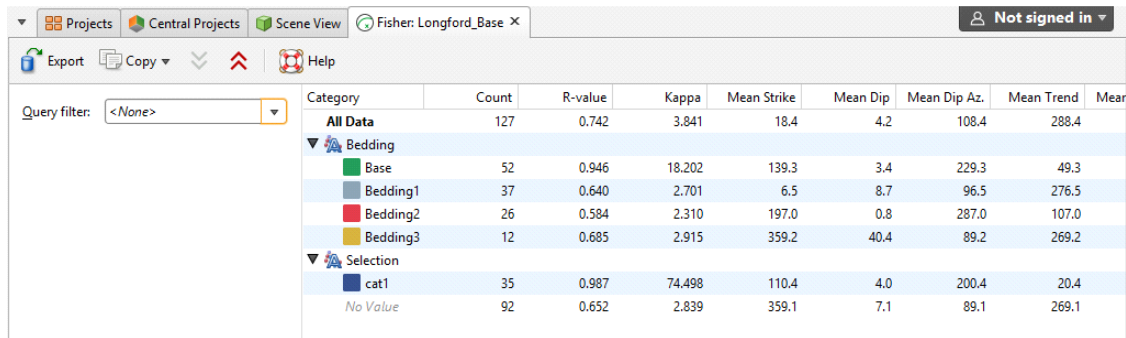

The screenshot shows a software window titled 'Fisher: Longford_Base'. It features a menu bar with 'Export', 'Copy', and 'Help'. Below the menu is a 'Query filter' dropdown set to '<None>'. The main area displays a table with the following data:

Category	Count	R-value	Kappa	Mean Strike	Mean Dip	Mean Dip Az.	Mean Trend	Mean
All Data	127	0.742	3.841	18.4	4.2	108.4	288.4	
Bedding								
Base	52	0.946	18.202	139.3	3.4	229.3	49.3	
Bedding1	37	0.640	2.701	6.5	8.7	96.5	276.5	
Bedding2	26	0.584	2.310	197.0	0.8	287.0	107.0	
Bedding3	12	0.685	2.915	359.2	40.4	89.2	269.2	
Selection								
cat1	35	0.987	74.498	110.4	4.0	200.4	20.4	
No Value	92	0.652	2.839	359.1	7.1	89.1	269.1	

You can select specific rows and copy them to the clipboard or copy all data to the clipboard. You can also export the data in *.csv format.

Assigning Structural Data to Categories

There are two ways to initiate structural data selection: from the data object in the project tree/shape list and from a stereonet. The advantage of initiating structural data selection from a stereonet is that the data will be displayed both on the stereonet and in the scene window. This provides the most flexibility for analysing what data belongs to what category. See [Selecting Data in the Stereonet](#) and [Using the Scene Window with the Stereonet](#) for more information.

If you wish to assign planar structural data points or lineations to categories, right-click on the data table in the project tree and select **New Category Selection**. First, select the **Source Column**. If you select an existing column as the **Source Column**, you can assign selected data points to existing categories or create new categories. If you select **<None>** for the **Source Column**, you will have to define each category manually.

Select points by clicking on the **Select points** tool () , then drawing over those points in the scene:

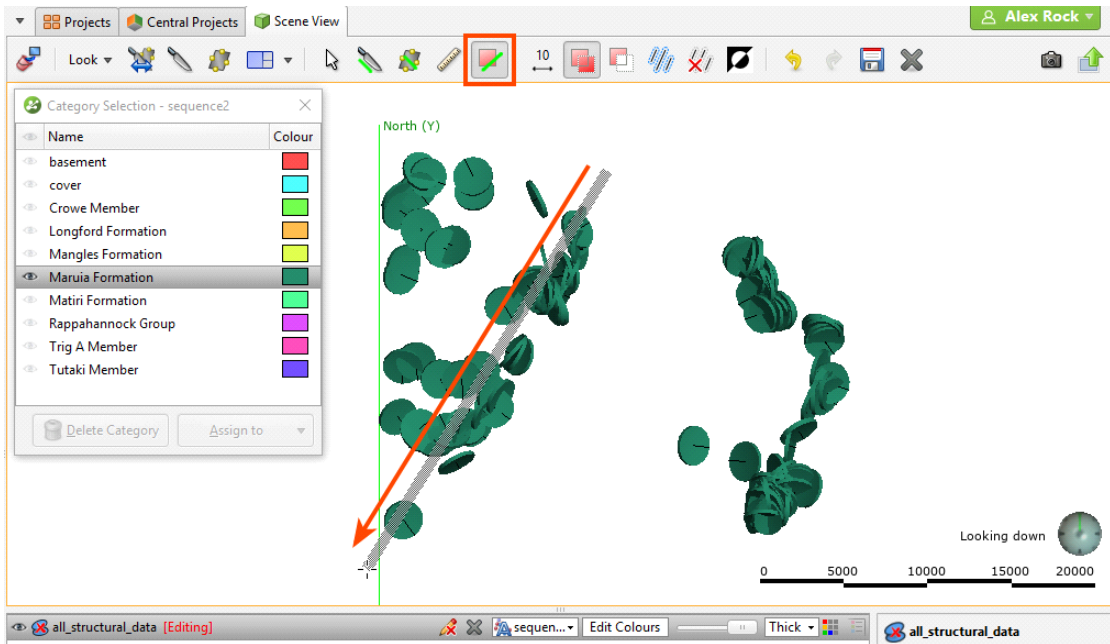

Once you have selected points, you can assign them to existing categories or create new ones. To create a new category, click on the **Assign to > Create New Category** button:

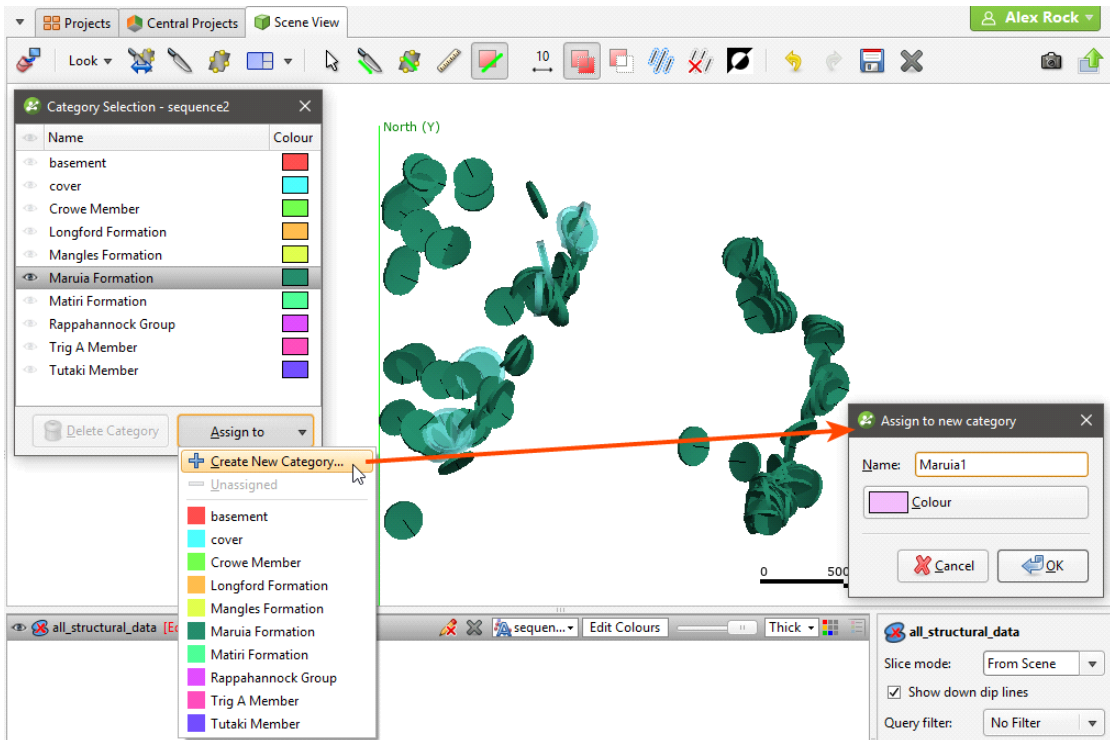

Enter a name for the new category and click **OK**.

When you have finished selecting points and adding them to categories, close the **Category Selection** window to close the editor.

Editing the Orientation of Planar Structural Data

If you need to edit the orientation of planar structural data points, you can do so in two ways:

- Edit the data in the table directly by double-clicking on the structural data table in the project tree. See [Working with Data Tables](#).
- Edit the structural data orientation in the scene.

To edit the structural data in the scene, right-click on the table in the project tree and select **Edit Orientation in Scene**. If the table is displayed in the scene, in the shape list, click on the **Edit** button (✎). The **Planar Structural Data** window will appear in the scene, together with controls for editing the data points. To edit a data point, click on it. Information about the selected point will be displayed in the **Planar Structural Data** window, together with controls in the scene you can use to adjust the point:

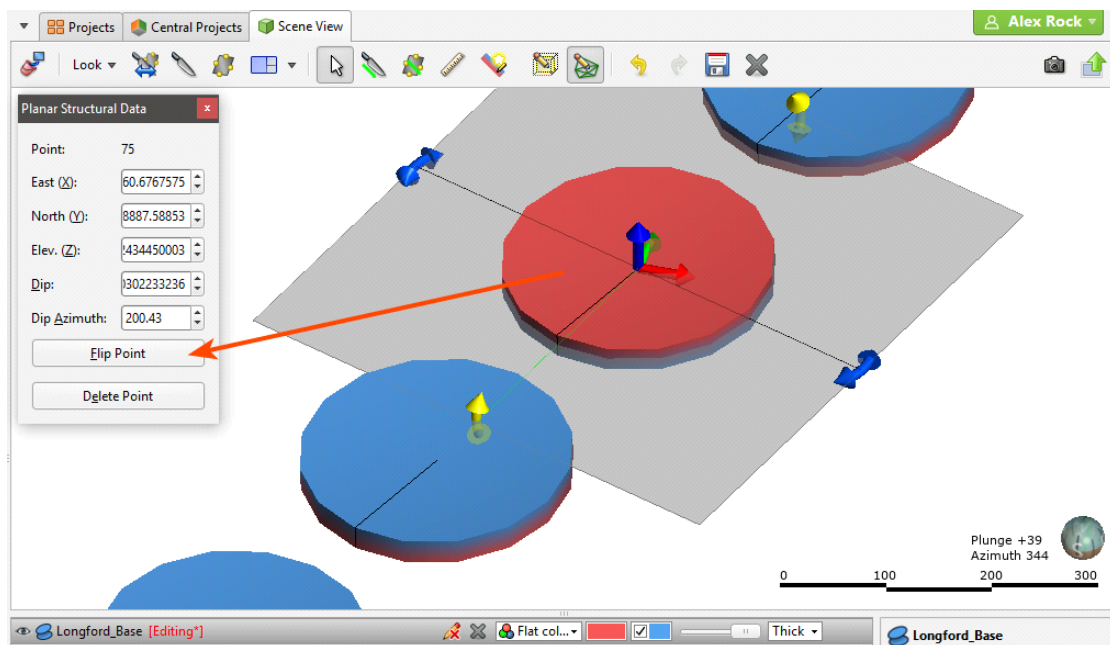

You can also add new data points in the same manner described in [Creating New Planar Structural Data Tables](#).

Declustering Planar Structural Data

If a planar structural data table contains multiple duplicate or near-duplicate measurements, you can create a declustered structural data set that will make the table easier to work with. Declustering is intended to work with large, machine-collected data sets rather than smaller sets that might be edited manually.

Declustering preserves the original data table and creates the set as a “filter” by applying two parameters: the **Spatial search radius** and the **Angular tolerance**.

- The **Spatial search radius** determines the size of the declustering space. All points inside the **Spatial search radius** are compared searching for duplicates.

- The **Angular tolerance** measures whether points have the same or similar orientation. The orientation of all points inside the **Spatial search radius** is measured and the mean taken. If a point's orientation is less than the **Angular tolerance** from the mean, then the point is regarded as a duplicate. The point that is retained is the one that is closest to the mean.

When a structural data set has a numeric column that gives some indication of the measurement's uncertainty, this column can be used to prioritise values. Select the **Priority column** and set how the values should be handled.

Another factor in declustering the points is the category columns selected. When you choose multiple category columns, all criteria must match for points to be regarded as duplicates. What this means is that points will be kept if they have different category values in just one column, even if they meet the criteria for duplicates established by the **Spatial search radius** and the **Angular tolerance** and match in other columns. For example, in this table, assume that applying the **Spatial search radius** and the **Angular tolerance** parameters without using the Lithology category results in three points. However, including the Lithology column results in five points, indicated by the colours:

Dip	Dip-azimuth	Lithology
25	334	A
25	334	A
25	334	B
25	139	C
25	139	C
25	139	C
15	114	B
15	114	B
15	114	A

The more columns you select, the lower the likelihood that points will be regarded as duplicate.

The declustered set can be used like an ordinary structural data table. However, it is a filter on a planar structural data table and can be used as such when the parent table is displayed in the scene. For example, here the filters available for the planar structural data table include the query filters () defined for the table as well as the declustered set ():

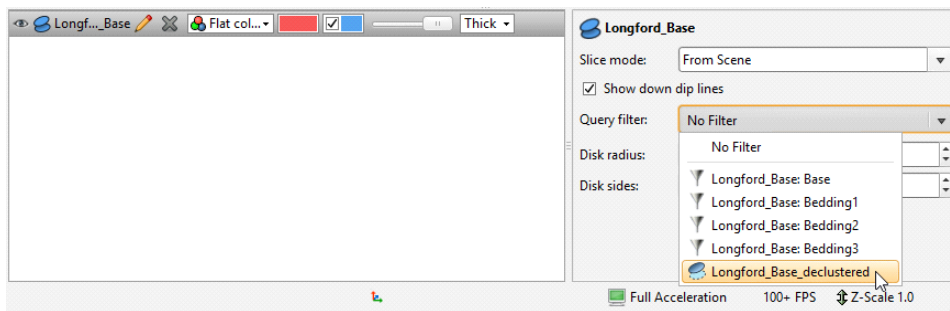

To create a declustered structural data set, right-click on the **Structural Modelling** folder and select **New Declustered Structural Data**. Select the source data table and a query filter, if required. Set the parameters and the columns you wish to use, then click **OK**. The declustered set will be added to the **Structural Modelling** folder.

Edit the set by right-clicking on it in the project tree and selecting **Edit Declustered Structural Data**.

Setting Elevation for Structural Data

You can set the elevation for planar structural data points or lineations by projecting the data onto a surface. Any elevation data in the data table will be overwritten by the elevation values from the selected surface.

To set the elevation for planar structural data points or lineations, right-click on the table in the project tree and select **Set Elevation**. The **Set Elevation from Surface** window will appear:

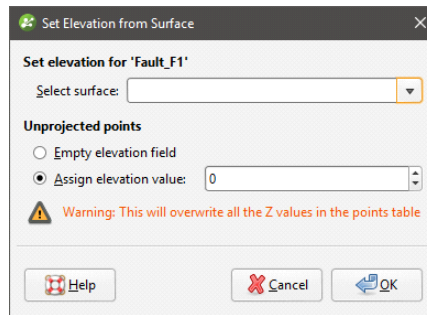

Select from the surfaces available in the project.

Unprojected points are data points that do not vertically intersect the selected surface. There are two options for handling these points:

- Leave the elevation field empty.
- Assign a fixed elevation value.

Click **OK** to set elevation values.

Estimating Planar Structural Data

You can generate a set of planar structural measurements from points, polylines and GIS lines. To do this, right-click on the points or lines object in the project tree and select **Estimate Structural Data**. In the window that appears, enter a name for the structural data table, then click **OK**. The new structural data table will appear in the project tree and you can view and edit it as described in [Displaying Structural Data](#) and [Editing the Orientation of Planar Structural Data](#).

Meshes

In Leapfrog Geothermal, meshes are used to represent surfaces in the form of vertices and triangles that define the 3D shape of the surface. Meshes can be open or closed. Meshes are generated as part of the model-building process, but can also be imported into a project or created directly in the project. Leapfrog Geothermal has several tools for adjusting meshes.

The **Meshes** folder contains all meshes imported into Leapfrog Geothermal and created in Leapfrog Geothermal outside of the model building process.

Two types of meshes are stored in the **Meshes** folder:

- Non-editable meshes (📁) are meshes imported into Leapfrog Geothermal and meshes created in Leapfrog Geothermal from the moving plane, **Meshes > Mesh Operations** tools and by extracting mesh parts from other surfaces in the project.
- Editable meshes (📁) are created in Leapfrog Geothermal from data objects such as points data, GIS data and polylines. Editable meshes can be refined by adding more data. Editable meshes can be interpolated meshes (using FastRBF) or triangulated meshes (using Delaunay triangulation). Interpolated meshes can also be created from structural data and values objects.

The rest of this topic is divided into:

- [Cleaning Up a Mesh](#)
- [Importing a Mesh](#)
- [Reloading a Mesh](#)
- [Displaying Surfaces](#)
- [Importing Meshes from Central](#)
- [Exporting Meshes](#)

Cleaning Up a Mesh

There are several options for cleaning up a mesh that can be applied to meshes imported into Leapfrog Geothermal and to non-editable meshes created in Leapfrog Geothermal.

To clean up a mesh, double-click on the mesh in the **Meshes** folder or right-click on the mesh and select **Open**. The **Cleanup Mesh** window will be displayed:

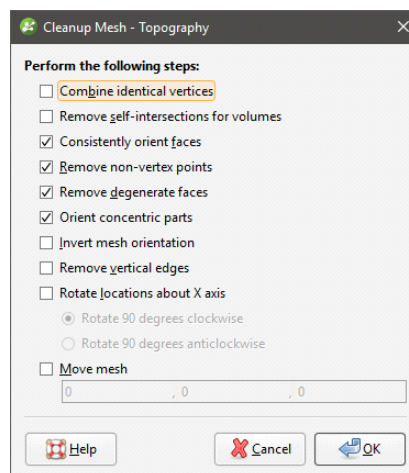

The **Cleanup Mesh** window will also be displayed when you import meshes.

The first option, **Combine identical vertices**, is intended for snapping cases where vertices occupy the exact same point in space. When enabled, vertices that have the exact same coordinates will be merged.

When enabled, **Combine identical vertices** occurs before the other processing actions in the **Cleanup Mesh** window.

The next option, **Remove self-intersections for volumes**, retriangulates self-intersecting triangles and trims away remaining open surfaces, whether they lie inside or outside the mesh. Before applying the **Remove self-intersections for volumes** option, check whether the mesh is open or closed. To do this, right-click on it in the project tree and select **Properties. Closed** should be True:

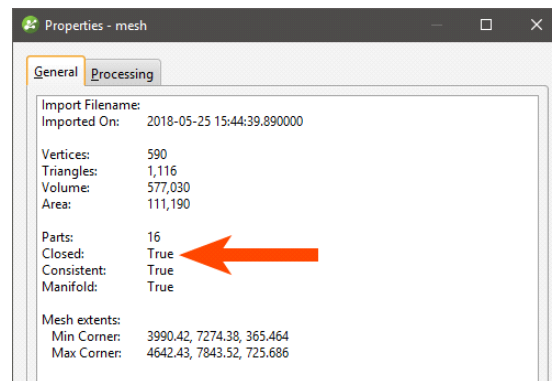

A mesh may appear to be closed in the scene but the **Closed** property will be false. Such a mesh may be made up of open parts that do not join up perfectly to make a closed mesh. If **Remove self-intersections for volumes** is enabled for such a mesh, it may disappear when it is trimmed.

Remove self-intersections for volumes should not be enabled for surface-like open meshes.

You may wish to enable **Remove self-intersections for volumes** if a mesh is reporting as open but is more volume-like than surface-like. Such a mesh may have a single open part that needs to be removed, or it may have open parts that line up perfectly and can be retriangulated to form a closed mesh.

The next four options are automatically applied to meshes created in or imported into Leapfrog Geothermal:

- **Consistently orient faces** ensures that a mesh can be used for inside/outside testing.
- **Remove non-vertex points** removes points that are not used by any triangles.
- **Remove degenerate faces** removes triangles with duplicate vertices.
- **Orient concentric parts** ensures that internal parts have the correct orientation.

Other options are:

- **Invert mesh orientation** reverses the polarity of the mesh.
- **Remove vertical edges** removes any vertical faces from the mesh boundary.
- **Rotate locations about X axis** lets you rotate the mesh 90 degrees clockwise or anticlockwise.
- **Move Mesh** lets you offset the mesh by a vector. Tick the **Move Mesh** box and enter the required values. The offset values can be changed by opening the **Clean Mesh** window once again.

Select the options required, then click **OK**.

The mesh will be added to the project tree under the **Meshes** folder.

Importing a Mesh

Mesh formats Leapfrog Geothermal supports include:

- Leapfrog Files (*.msh, *.ara)
- Gocad Files (*.ts)
- DXF Files (*.dxf)
- Surpac Files (*.str, *.dtm)
- Gemcom Files (*.tri)
- Datamine Files (*.pt.asc, *.tr.asc)
- Micromine Files (*MMpt.dat, *MMtr.dat)
- DXF Polyface Files (*.dxf)
- Alias Wavefront Object Files (*.obj)

Once a mesh has been imported to the project, you can evaluate it against any interpolant or distance function in the project. See [Evaluations](#) for more information.

To import a mesh, right-click on the **Meshes** folder and select **Import Mesh**. Navigate to the folder that contains the mesh file and select the file. You can select multiple files using the Shift and Ctrl keys. Click **Open** to import the file.

The **Cleanup Mesh** window will be displayed. See [Cleaning Up a Mesh](#). Select the options required, then click **OK**.

The mesh will be added to the project tree under the **Meshes** folder.

Meshes with Textures

Leapfrog Geothermal can import OBJ meshes with textures. Image formats supported include:

- PNG Files (*.png)
- JPEG Files (*.jpg, *.jpeg)
- TIFF and GeoTIFF Files (*.tiff, *.tif)
- Windows Bitmap Files (*.bmp)
- Graphics Interchange Format Files (*.gif)

The texture is automatically imported when the mesh is imported and will appear in the project tree under the mesh.

Reloading a Mesh

Meshes imported into Leapfrog Geothermal and created from extracting mesh parts can be reloaded. To do this, right-click on the mesh in the project tree and select **Reload Mesh**.

Navigate to the file that should be used and click **Open**.

Displaying Surfaces

Leapfrog Geothermal assigns different colours to each side of a surface.

A basic mesh will have an inside (coloured red) and an outside (coloured blue):

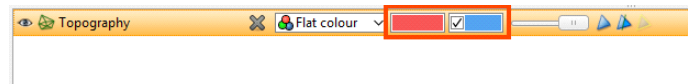

In the case of contact surfaces, each side will be assigned a lithology. "Unknown" will be used if multiple lithologies are contacted. Contact surfaces can be displayed using the assigned lithologies or the younging direction:

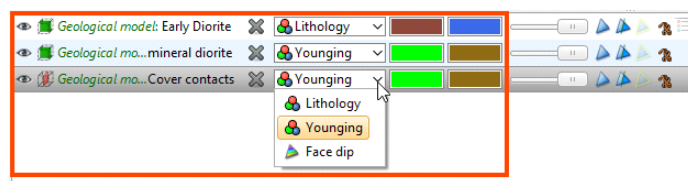

When a contact surface is displayed by its younging direction, the younger side of the surface will be displayed in green and the older side in brown.

Veins can also be displayed coloured with the thickness values.

Surfaces that are part of a geological model or interpolant are, by default, displayed clipped to the model boundary:

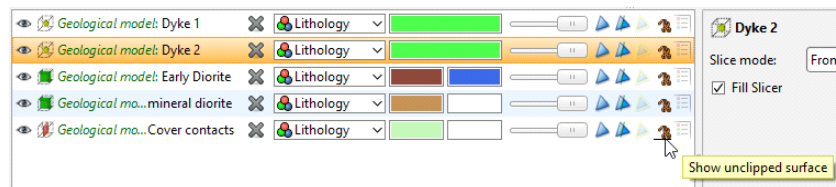

Disable the **Clipped surface** button (🗑️) to view the surface unclipped.

Draping an Image on a Mesh

You can drape images on any mesh in the **Meshes** folder. To do this, right-click on the mesh in the **Meshes** folder and select one of the **Drape Image** options.

- For the **Import Image** option, you will be prompted for a file location. Navigate to the folder containing the image you wish to drape, select the file and click **Open**. Set georeferencing information for the image, if required, then click **OK**. See [Importing a Map or Image](#) for more information on georeferencing images. The imported image will appear in the project tree under the mesh.
- For the **Select Existing Image** option, select from the images available in the project and click **OK**. A hyperlink to the image will appear in the project tree under the mesh.

You can drape as many images as required. When the mesh is displayed in the scene, you will be able to select any draped images from the list of display options.

When you import and georeference an image, you can then export it as a GeoTIFF. To do this, right-click on it in the project tree and select **Export**. You will be prompted for a filename and location. Click **Save**.

Importing Meshes from Central

When you are working in a Central project, you can import meshes from other Central projects on the same server. Importing meshes from Central allows you to easily share data between projects without having to manually export and re-import the data. In addition, if the mesh is out-of-date, you can reload it from Central.

Importing Central Meshes

To import a mesh from Central, first make sure you are already connected to Central. Then right-click on the **Meshes** folder and select **Import Mesh From Central**. In the window that appears, select one of the projects in the repository. Next, the project history will be displayed. Select a version to view a list of available objects, then click on a model to load its list of surfaces. Here, the surfaces from the Lithology geological model have been loaded, while the surfaces in the **Numeric Models** folder have not:

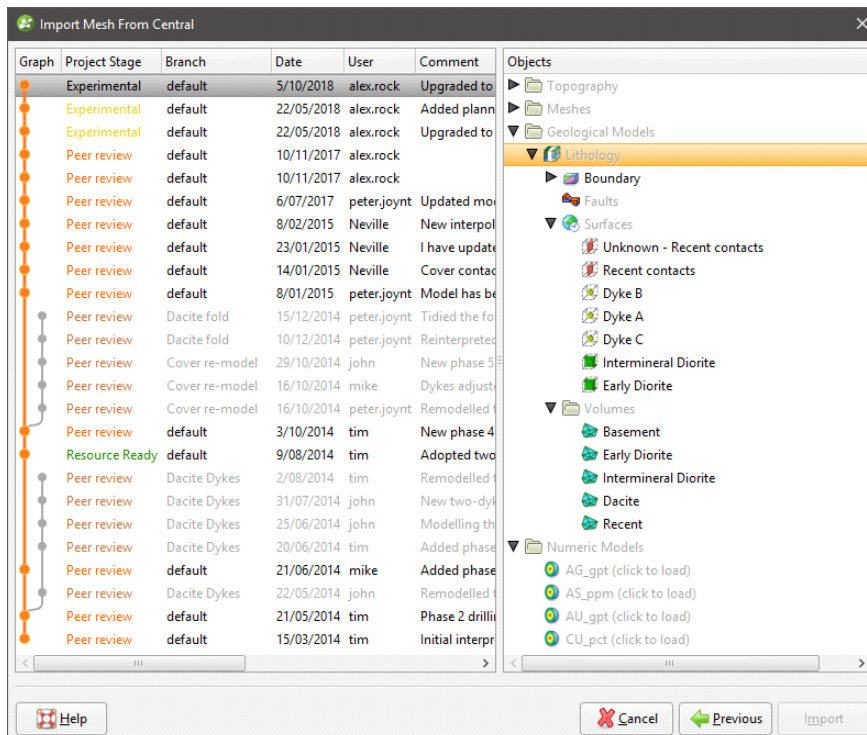

Use the Shift and Ctrl keys to select as many objects as required. Click **Import** to import the objects, which will be saved into the **Meshes** folder.

A different colour is used to indicate meshes imported from Central (👤), and viewing the properties shows you what version of the project the mesh came from:

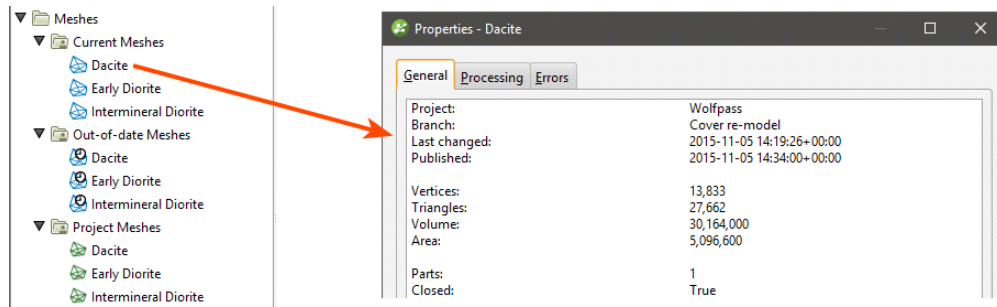

When you import a mesh from Central, Leapfrog Geothermal checks to see if the mesh is the latest version from that branch. Out-of-date meshes (👤) are indicated in the project tree.

Updating Out-of-Date Meshes

There are two options for updating an out-of-date mesh:

- **Reload Latest on Branch** imports the newest mesh available on the branch the out-of-date mesh was imported from.
- **Reload From Central** displays the project history and allows you to pick any point in time on any branch.

Right-click on a mesh and choose one of these options.

If you have selected multiple meshes in the project tree, the **Reload Latest on Branch** option is the only one available:

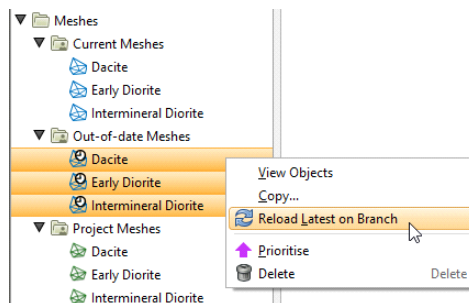

Exporting Meshes

Leapfrog Geothermal exports meshes in the following formats:

- Leapfrog Files (*.msh)
- Gocad Files (*.ts)
- DXF Files (*.dxf)
- Surpac Files (*.dtm, *.str)
- Gemcom Files (*.tri)

- Datamine Files (*.pt.asc, *.tr.asc)
- Micromine Files (*.MMpt.dat, *.MMtr.dat)
- DXF Polyface Files (MineCAD) (*.dxf)
- Alias Wavefront Object Files (*.obj)
- Drawing Files (2013/LT2013) (*.dwg)
- Bentley Drawing Files (v8) (*.dgn)

You can export single meshes or batch export meshes from the **Meshes** folder or from individual models. Each of these is described below:

- [Exporting a Single Mesh](#)
- [Exporting Multiple Meshes from the Meshes Folder](#)
- [Exporting Multiple Meshes from Models](#)

Exporting a Single Mesh

To export a mesh, right-click on the mesh and select **Export**. The **Export Mesh Parts** window will appear:

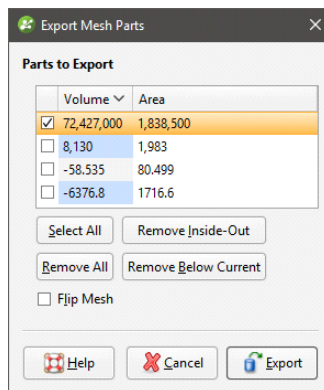

An **Export clipped mesh** option is available for meshes that are clipped to a boundary:

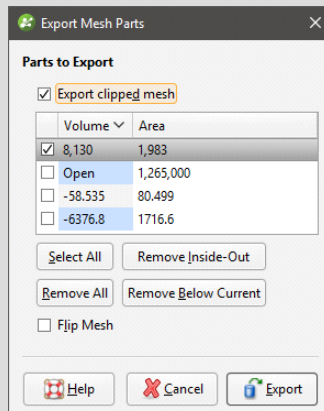

If the quality of the mesh produced is not acceptable, clip the mesh as described in [Clipping a Mesh](#), then export the mesh.

Select the **Parts to Export**, then click **OK**. You will be prompted for a filename and location.

When exporting a mesh that has multiple parts, you can distinguish between the different parts by clicking on them in the **Export Mesh Parts** window. Here, the mesh was added to the scene before the **Export Mesh Parts** window was opened. Clicking on a mesh part in the list selects that part in the scene:

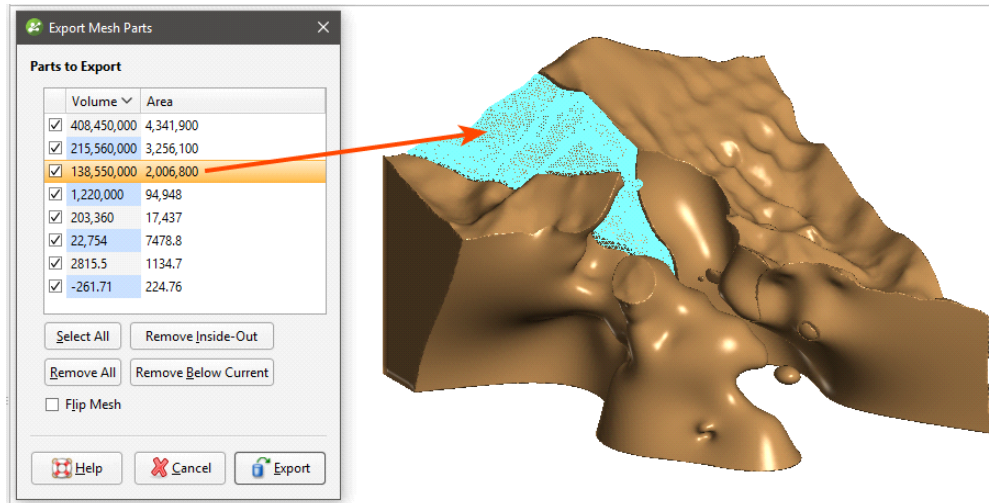

If the mesh is not in the scene when the **Export Mesh Parts** window is opened, selecting a part in the list will display it in the scene without reference to the other parts of the mesh:

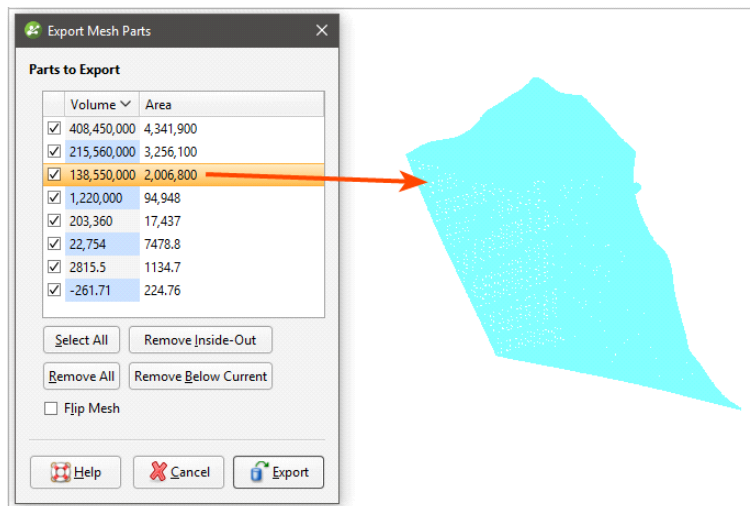

Use the Shift and Ctrl keys to select and view multiple mesh parts in the scene:

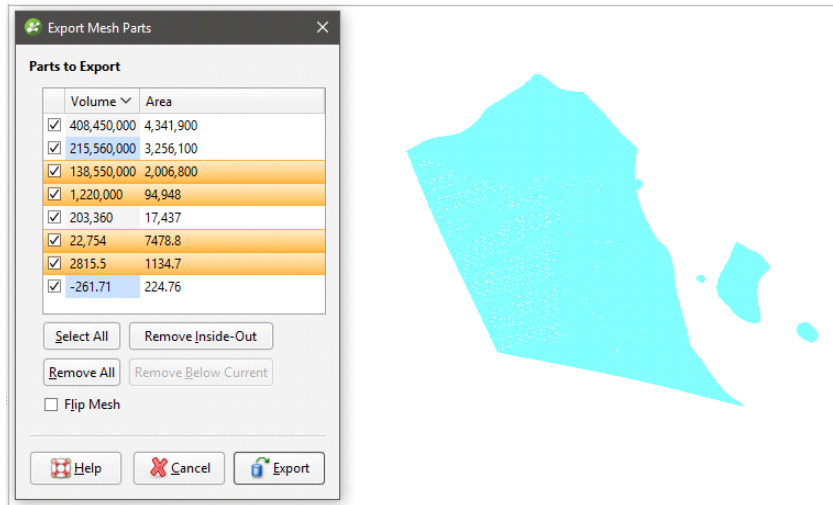

Exporting Multiple Meshes from the Meshes Folder

To export multiple meshes from those in the **Meshes** folder, right-click on the **Meshes** folder and select **Export Meshes**. In the window that appears, select the meshes you wish to export:

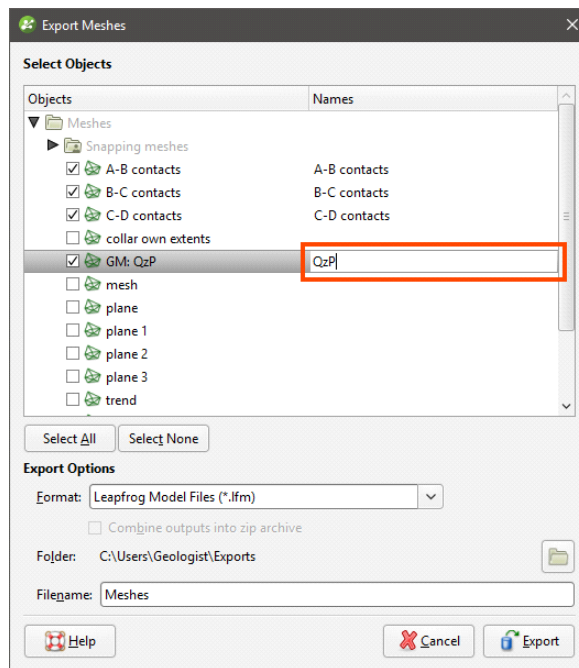

The filename that will be used for each mesh is shown in the **Filenames** column. To change the filename for any of the meshes, click on its name in the **Filenames** column.

Next, select the format required and where to save the exported meshes. Available formats are:

- Leapfrog Model Files (*.lfm)
- Leapfrog Files (*.msh)
- Gocad Files (*.ts)

- DXF Files (*.dxf)
- Surpac Files (*.dtm, *.str)
- Gemcom Files (*.tri)
- Datamine Files (*.pt.asc, *.tr.asc)
- Micromine Files (*.MMpt.dat, *.MMtr.dat)
- DXF Polyface Files (MineCAD) (*.dxf)
- Alias Wavefront Object Files (*.obj)
- Drawing Files (2013/LT2013) (*.dwg)
- Bentley Drawing Files (v8) (*.dgn)

Click **Export** to save the meshes.

Exporting Multiple Meshes from Models

You can export multiple meshes from individual geological models, numeric models, combined models and static models. To export meshes in this way, right-click on a model or interpolant and select **Export**. In the window that appears, select the volumes and surfaces you wish to export:

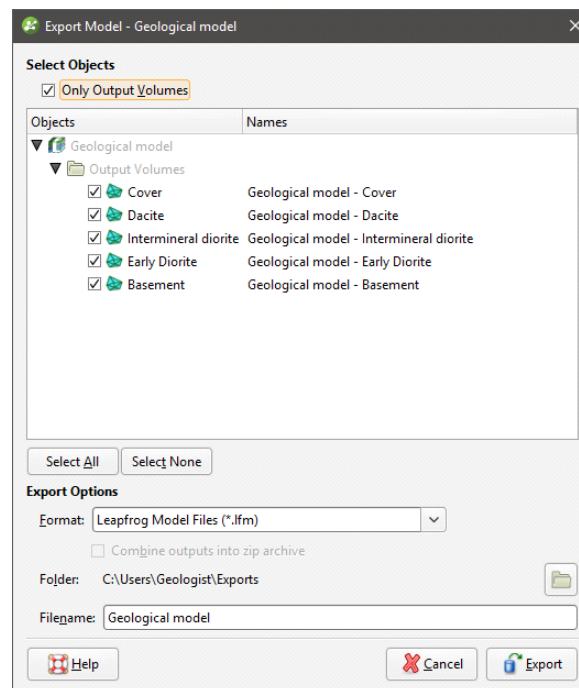

For geological models, if you wish to export surfaces other than the output volumes, untick the **Only Output Volumes** option.

For faulted geological models, you also can select from the faulted volumes by ticking the **Faulted Volumes** box:

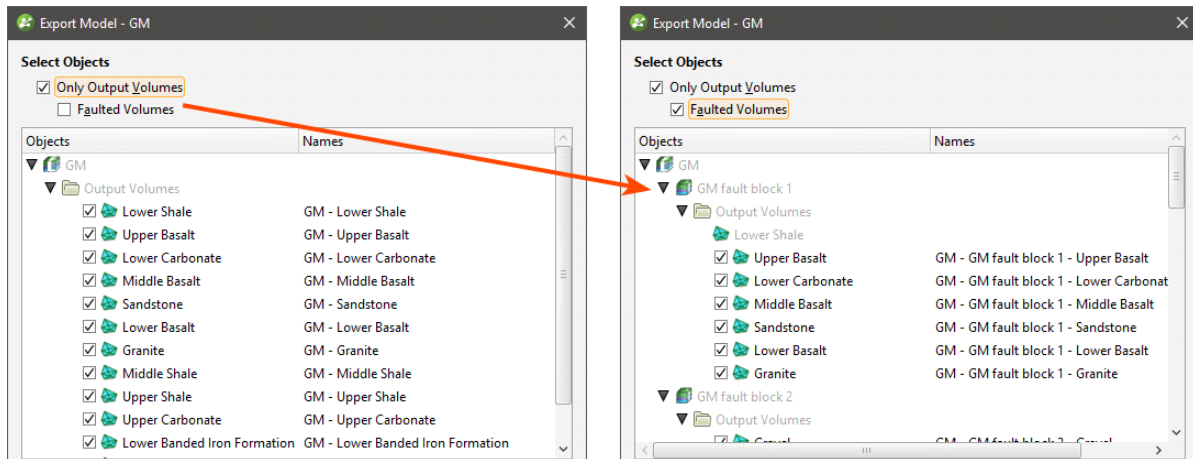

The filename that will be used for each mesh is shown in the **Filenames** column. To change the filename for any of the meshes, click on its name in the **Filenames** column.

Next, select the format required and where to save the exported meshes. Available formats are:

- Leapfrog Model Files (*.lfm)
- Leapfrog Files (*.msh)
- Gocad Files (*.ts)
- DXF Files (*.dxf)
- Surpac Files (*.dtm, *.str)
- Gemcom Files (*.tri)
- Datamine Files (*.pt.asc, *.tr.asc)
- Micromine Files (*.MMpt.dat, *.MMtr.dat)
- DXF Polyface Files (MineCAD) (*.dxf)
- Alias Wavefront Object Files (*.obj)
- Drawing Files (2013/LT2013) (*.dwg)
- Bentley Drawing Files (v8) (*.dgn)

For any of the export options other than Leapfrog Model Files format, you can save the meshes as a zip file.

The Leapfrog Model File format exports a single *.lfm file. If the file is imported into the **Meshes** folder, each output volume will appear as a single mesh.

Click **Export** to save the meshes.

Modifying Surfaces

This topic describes aspects of modifying surfaces in Leapfrog Geothermal. It is divided into:

- [Surface Resolution in Leapfrog Geothermal](#)
- [Adding Data to Surfaces](#)
- [Honouring Surface Contacts](#)
- [Global Trends](#)
- [Structural Trends](#)
- [Editing Surfaces with Polylines](#)
- [Editing Surfaces with Structural Data](#)

Surface Resolution in Leapfrog Geothermal

In Leapfrog Geothermal, meshes are used to represent surfaces in the form of vertices and triangles that define the 3D shape of the surface. The resolution of a surface is controlled by the size of the triangles used to create a surface. A lower surface resolution value means smaller triangles and, therefore, a finer resolution. A higher surface resolution value will take less time to process but the surface may not show the level of detail required.

When a surface is imported, Leapfrog Geothermal automatically sets a surface resolution based on the information in the file. It is not possible to change the resolution of surfaces imported into Leapfrog Geothermal. The exception is elevation grids (see [Importing an Elevation Grid](#)).

When surfaces are created, Leapfrog Geothermal sets a default resolution based on the data available. You can set a lower value, but calculations will take longer. In addition, the resolution for many surfaces can be adaptive; that is, areas closer to data will have a finer resolution than areas further away from data.

To see the effect of different resolution settings, consider a simple geological model of three rock types. Here, the surface resolution is set to 50 and the adaptive isosurfacers are disabled:

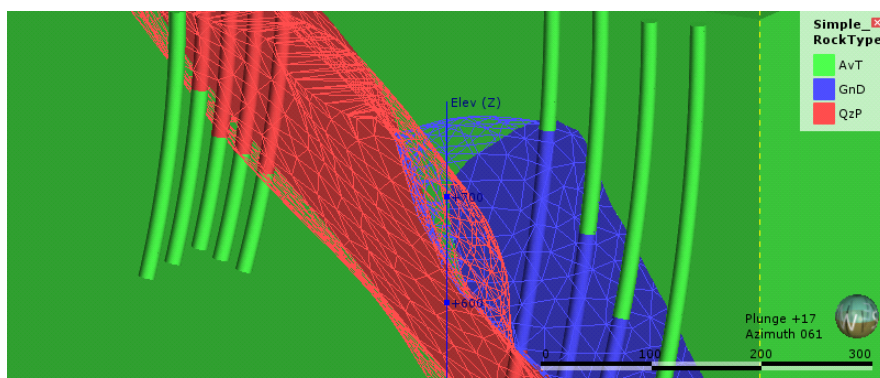

Here, the resolution has been reduced, which results in smaller triangles:

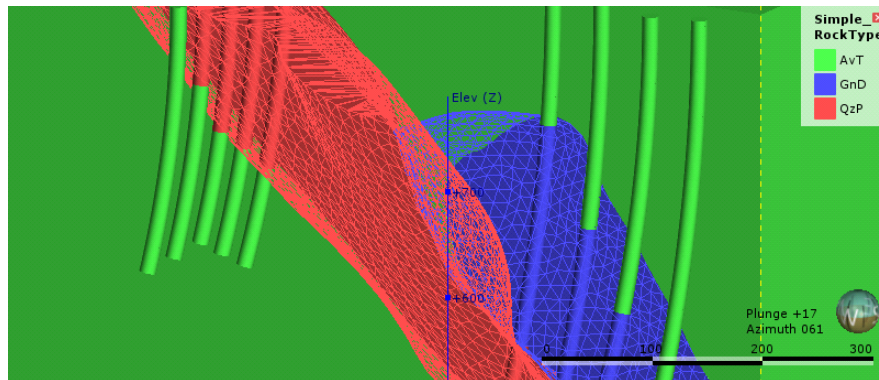

For both resolution settings above, the triangles are the same size everywhere in each surface, even where real data is available. Once the adaptive isosurfacers has been enabled, the triangles closer to the wells are smaller than those further away:

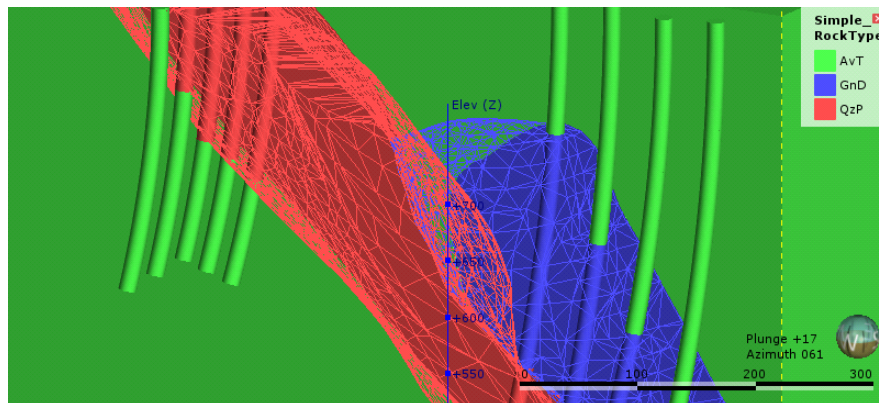

Areas of the surface that have large triangles indicate that there is less data in those areas to guide the interpolation of the surface.

In Leapfrog Geothermal, the resolution for different types of surfaces can be controlled as follows:

- For geological models, a resolution can be set for the model as a whole, but individual surfaces can have different settings. See [Surface Resolution for a Geological Model](#).
- For interpolants, the resolution of the output isosurfaces is controlled by a single setting that can be overridden for individual surfaces. See [Output Settings for an RBF Interpolant](#) and [Indicator RBF Interpolant Surfacing and Volume Options](#).
- The resolution can be changed for editable interpolated meshes (🌀) and can be adaptive. See [Interpolated Meshes](#).
- When the topography has been defined using multiple data sources, the resolution can be set and the adaptive option is available. See [Changing Topography Settings](#).

Adding Data to Surfaces

Many surfaces can be refined by adding points, structural data, GIS data and polylines. If a surface can be modified in this way, an **Add** menu will appear for the object when you right-

click on it in the project tree. For example, the **Add** menu for this contact surface shows the data types that can be used to refine the surface:

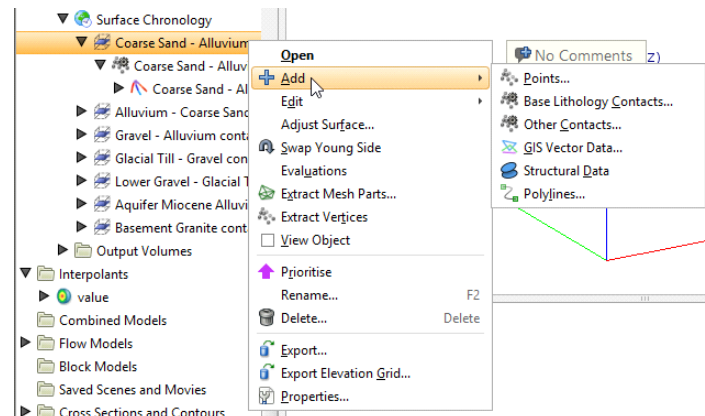

Select the type of data you wish to use to modify the surface. Leapfrog Geothermal will display all the suitable objects in the project. Select the required object and click **OK**. A hyperlink to the added data will appear under the surface in the project tree. The added data can be removed from the surface by expanding the surface in the project tree, then right-clicking on the hyperlinked data object and selecting **Remove**.

Honouring Surface Contacts

In Leapfrog Geothermal, surfaces can be created from well data, points data, structural data, GIS data and polylines. When surfaces are created from several different objects, it may be desirable to snap the surface to some data objects but not to others.

There are several options for snapping surfaces to data:

- **Off**. The surface does not snap to the data used to create it.
- **All data**. The surface snaps to data within the **Maximum snap distance**, which includes well data and any data added to the surface.
- **Drilling only**. The surface snaps to well data and data objects derived from well data within the **Maximum snap distance** but not to other data used to modify the surface. For example, the surface will honour points data derived from well data, but not points data imported into the **Points** folder.
- **Custom**. The surface snaps to selected data objects within the **Maximum snap distance**.

Snapping forces surfaces to honour the specified contacts, moving triangles on the surface so that the surface precisely intersects the contact. For example, snapping is disabled for the surface on the left, but enabled for the surface on the right. The points used to generate the surface are shown in red, and the triangles are displayed so you can see how snapping to data affects the surface:

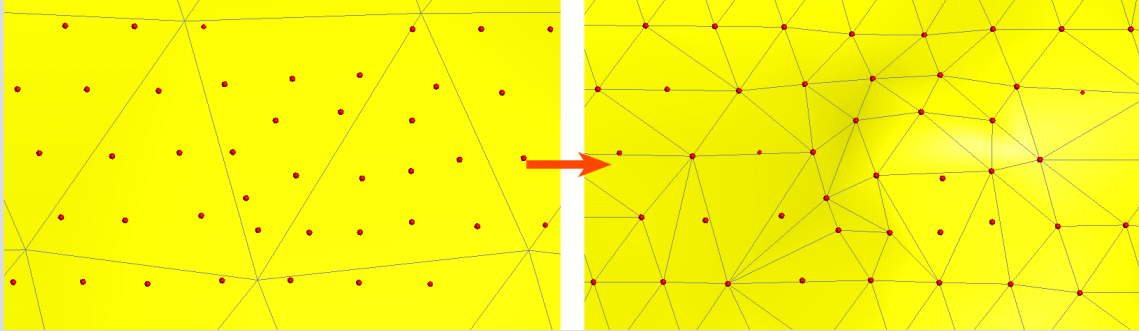

When snapping is enabled, the **Maximum snap distance** is used to determine what data should affect the surface. The **Maximum snap distance** is, by default, set to half of the **Surface resolution** setting, but you can adjust that up or down, if required.

In this image, three surfaces are shown, along with the points used to generate the surface (red). The grey surface is the surface that results when snapping is **Off**. For the yellow surface, snapping to the points is enabled and the **Maximum snap distance** has been set to a high value, resulting in the yellow surface snapping to the distant point indicated by the arrow. Snapping to points is also enabled for the blue surface, but the **Maximum snap distance** has been set to a lower value, so that the surface snaps to some close points, but does not snap to the distant point.

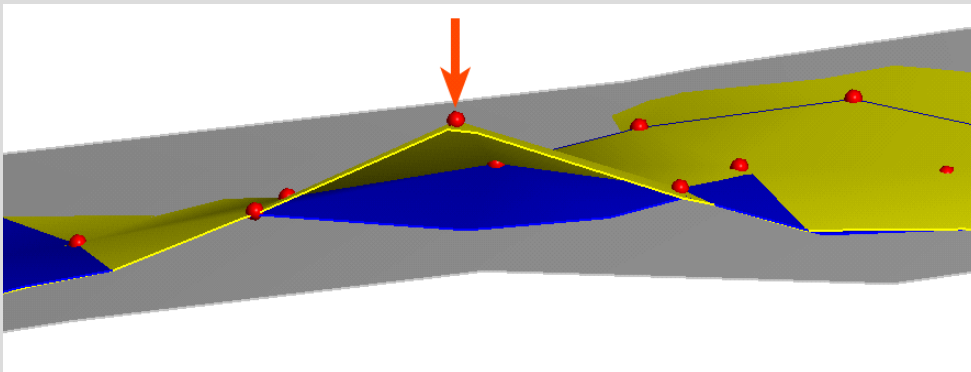

While the most suitable snapping option is always project- and purpose-specific, if you have sufficient drilling data, snapping to **Drilling only** is recommended. This option gives the highest priority to the input data itself while still allowing the surface to be influenced by manual interpretations. Contrary to the **All data** snapping option, the **Drilling only** option also reduces the potential for complications resulting from contradictory data (e.g. the drilling data indicates a surface contact is in one place, but a polyline indicates it's somewhere else).

Take care in enabling snapping and in selecting what data the surface will snap to, as the more data you include, e.g. by setting a large **Maximum snap distance** or selecting **All data** for **Snap to data**, the greater the possibility that errors in the data or assumptions inherent in

interpretations (e.g. polylines) will cause distortions in the meshes. If you do enable snapping, it is best to snap only to drilling data.

For example, here the **Snap to data** has been set to **Drilling only** for a mesh created from multiple data objects:

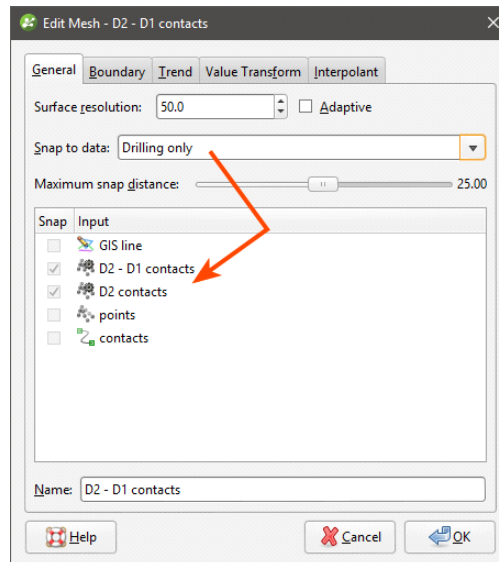

Note that the only objects **Snap** is enabled for are the contacts derived from well data.

Here, **Snap to data** has been set to **Custom**, which makes it possible to enable **Snap** for only the selected data objects:

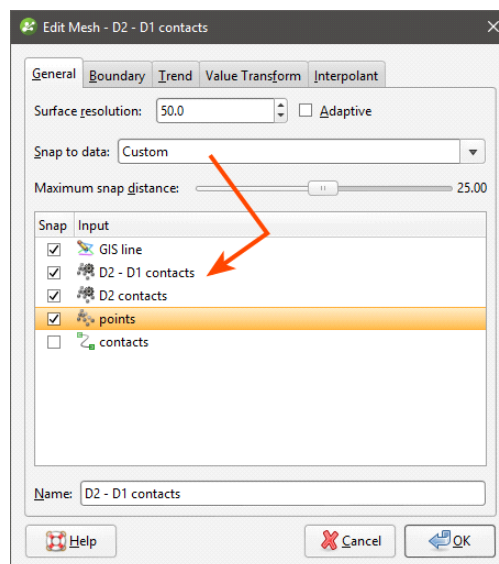

In Leapfrog Geothermal, the snap settings for different types of surfaces can be controlled as follows:

- For geological models, **Snap to data** can be set for the model as a whole, but individual surfaces can have different settings. For more information, see:

- [Editing a Geological Model](#)
 - [Surfacing Options for Deposits and Erosions](#)
 - [Surfacing Options for Intrusions](#)
 - [Surfacing Options for Veins](#)
 - [Surfacing Options for Faults](#)
 - [Changing Fault Inputs](#)
- For editable interpolated meshes and offset meshes (🌐), **Snap to data** can be set by double-clicking on the mesh and changing the settings in the **General** tab. See [Refining an Interpolated Mesh](#) and [Offset Meshes](#) for more information.

Global Trends

In Leapfrog Geothermal, many surfaces can be adjusted by applying a trend to the surface. To do this, add the surface you wish to adjust to the scene so that it can be used in setting the trend. Double-click on the surface in the project tree and select the **Trend** tab. Here, the **Trend** tab is displayed for a contact surface:

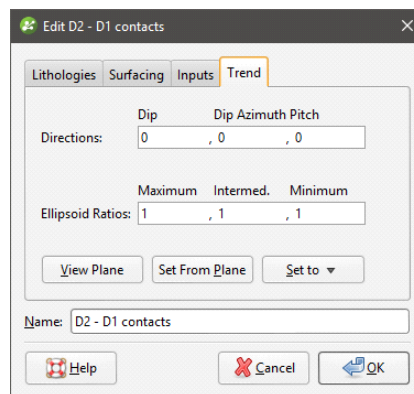

Often the easiest way to apply a trend is to click on the **Draw plane line** button (📐) and draw a plane line in the scene in the direction in which you wish to adjust the surface. You may need to rotate the scene to see the plane properly.

The **Ellipsoid Ratios** determine the relative shape and strength of the ellipsoids in the scene, where:

- The **Maximum** value is the relative strength in the direction of the green line on the moving plane.
- The **Intermed.** value is the relative strength in the direction perpendicular to the green line on the moving plane.
- The **Minimum** value is the relative strength in the direction orthogonal to the plane.

Once you have adjusted the plane to represent the trend you wish to use, click the **Set From Plane** button to copy the moving plane settings.

The **Set to** list contains a number of different options Leapfrog Geothermal has generated based on the data used in the project. **Isotropic** is the default option used when the surface was

created. Settings made to other surfaces in the project will also be listed, which makes it easy to apply the same settings to many surfaces.

Click **OK** to apply the changes.

How the moving plane can be used to adjust a surface in this manner is illustrated by the following intrusive contact surface:

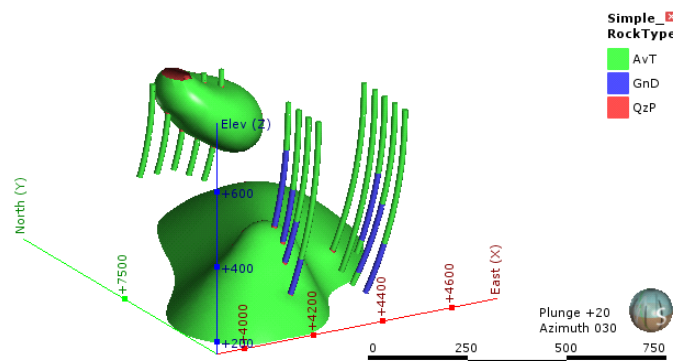

The intrusion surface has two bodies that are not connected, and we can apply a trend to connect the two parts. Here, the intrusion surface has been hidden in the scene and the scene rotated to line up the QzP segments. A plane line can then be drawn through the QzP segments:

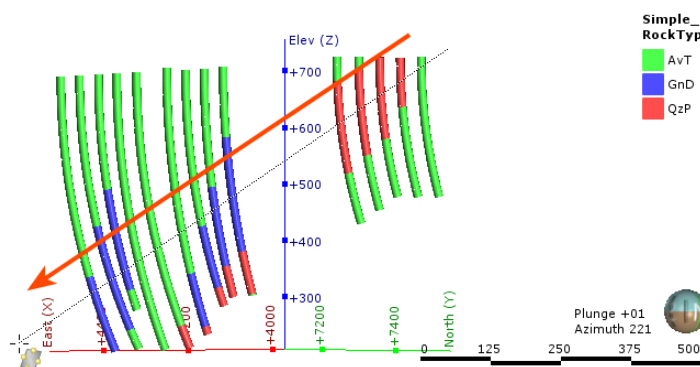

Using the plane settings to adjust the surface results in the two parts of the intrusion joining up:

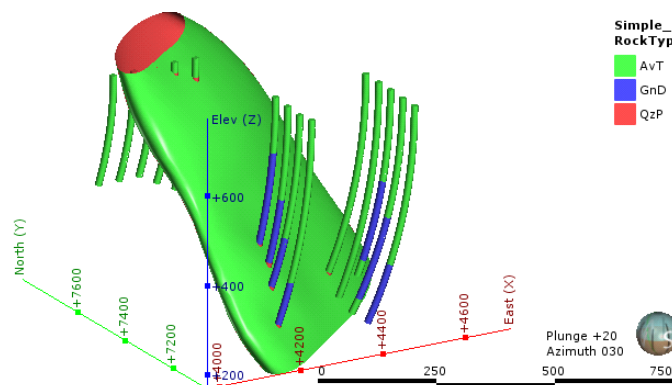

Structural Trends

Structural trends create a flat ellipsoid anisotropy that varies in direction with its inputs. This topic describes working with structural trends. It is divided into:

- [Creating a Structural Trend](#)
- [Displaying a Structural Trend](#)
- [Applying a Structural Trend](#)

Creating a Structural Trend

To create a new structural trend, right-click on the **Structural Trends** folder (in the **Structural Modelling** folder) and select **New Structural Trend**. The **Structural Trend** window will appear:

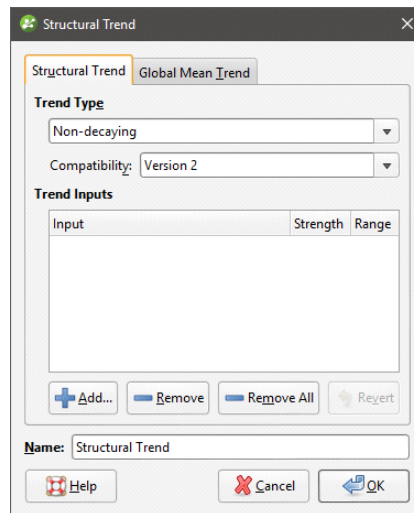

Structural trends can be created from surfaces and from structural data. Click **Add** to select from the suitable inputs available in the project. The list of inputs will be displayed:

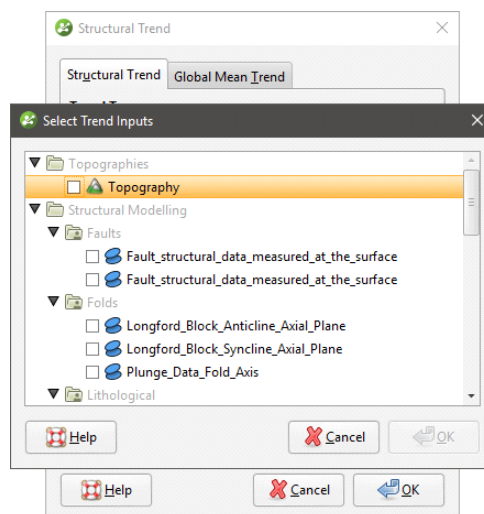

Tick the box for each input required, then click **OK**. The selected inputs will be added to the **Structural Trend** window:

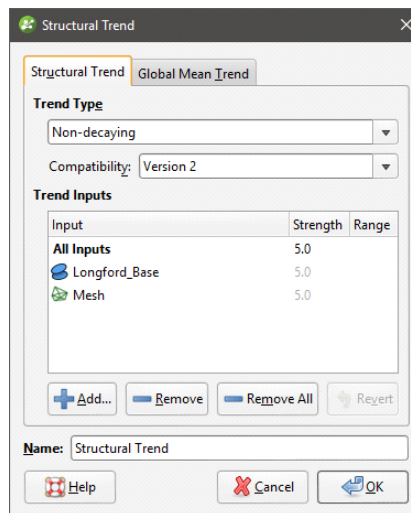

The **Strength** parameter determines the shape of the ellipsoid, and the **Range** parameter indicates how far the influence of this mesh reaches. If the **Trend Type** is **Non-decaying**, the distance from the mesh no longer affects the anisotropy and the **Range** value cannot be set. Trends that are **Strongest along meshes** or **Blending** can include a global trend. To set this, click on the **Global Mean Trend** tab.

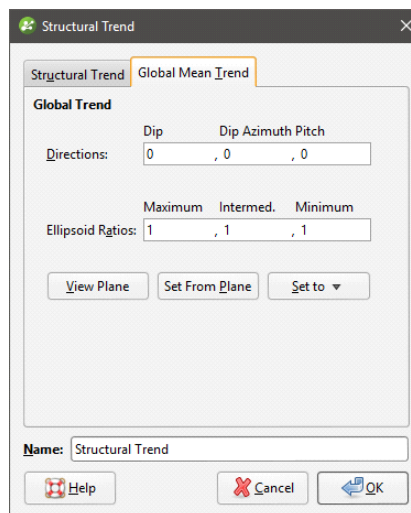

You can enter the trend manually or add the moving plane to the scene and set the trend using the moving plane, as described in [Global Trends](#).

The **Compatibility** setting determines the algorithm used to create the structural trend. Structural trends created in earlier versions of Leapfrog Geothermal (before 2.8) used the Version 1 algorithm. When these structural trends are upgraded, you can change them so they use Version 2, which may be desirable if adding more data to the trend results in significant changes in areas that are not close to new data.

Enter a **Name** for the trend and click **OK**. The new trend will appear under the **Structural Trends** folder.

Displaying a Structural Trend

When displayed in the scene, the trend is shown using disks placed on a regular grid:

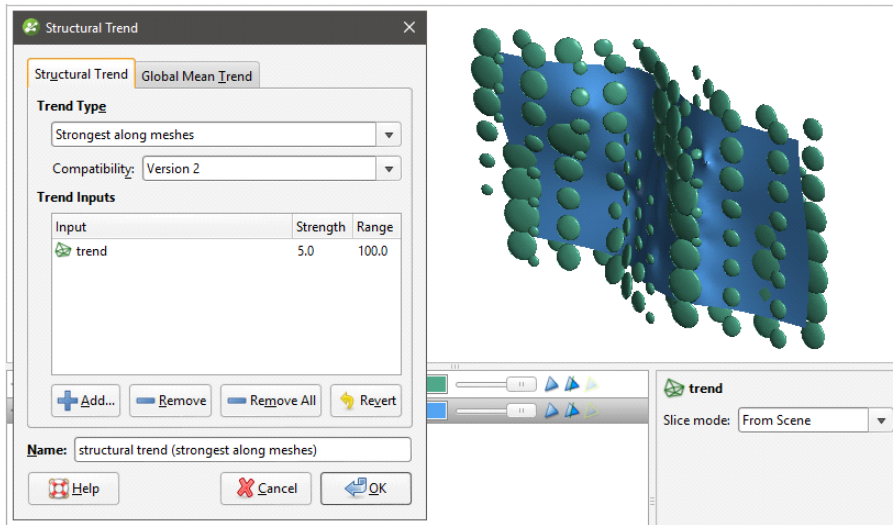

The orientation of the disk gives the direction of the anisotropy. The size of a disk is proportional to the anisotropy strength. Where there are no disks (or the size is very small) the trend is isotropic.

If the **Trend Type** is set to **Non-decaying**, the distance from the mesh no longer affects the anisotropy and all disks have the same size:

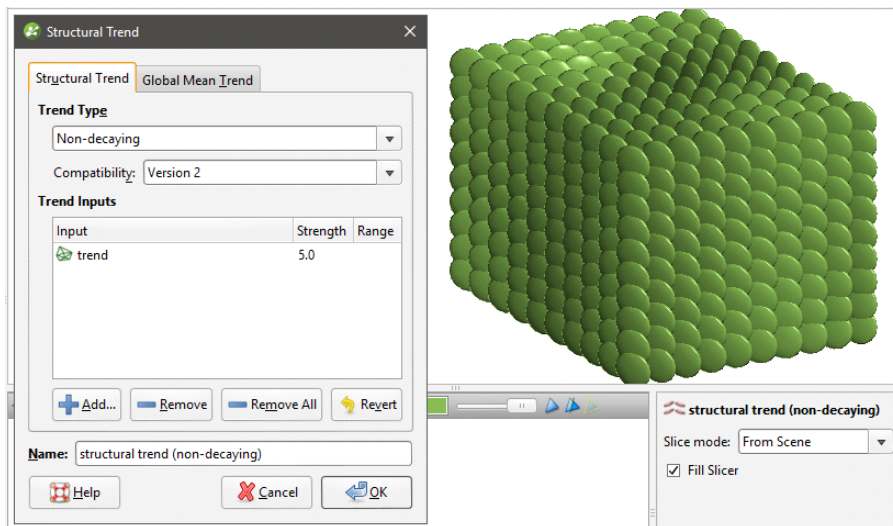

The **Blending** option requires multiple meshes and blends them according to their individual strength settings. A trend with higher strength makes a stronger impact on the blending. The blended trend is of decaying-type, and its strength weakens further away from the mesh.

Applying a Structural Trend

To apply a structural trend to an interpolated editable mesh or an interpolant, double-click on the object in the project tree and click on the **Trend** tab:

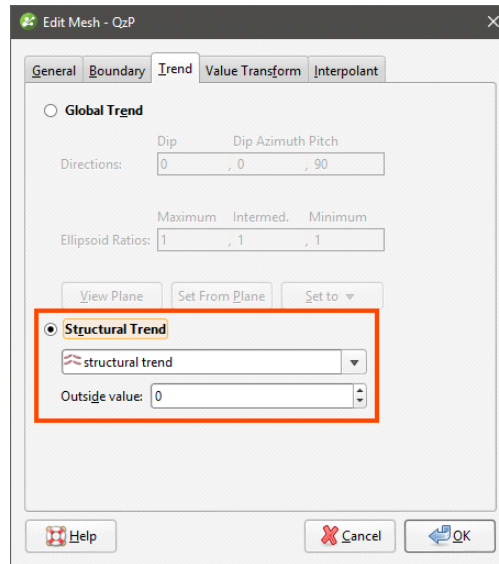

To apply a structural trend to an intrusion contact surface, enable **Show additional surfacing options** in the **Surfacing** tab, then click on the **Trend** tab.

Click on **Structural Trend**, then select the required trend from the list. Click **OK** to apply the trend to the surface.

When a structural trend is applied, surfaces may appear distorted further away from the data:

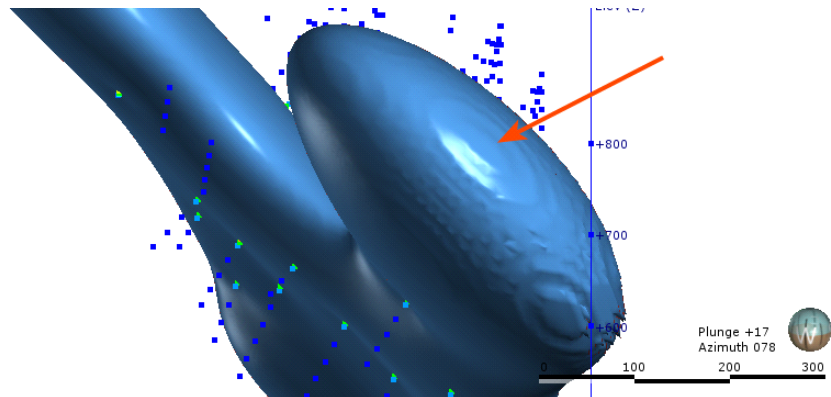

If this is the case, experiment with the **Outside value** setting. The **Outside value** is the long-range mean value of the data. Setting a value of -1 for intrusions (where the positive values are on the inside) and +1 for other surfaces will result in a smoother surface in most cases. For example, here, the **Outside value** has been set to -1 for this intrusion, resulting in a much smoother surface:

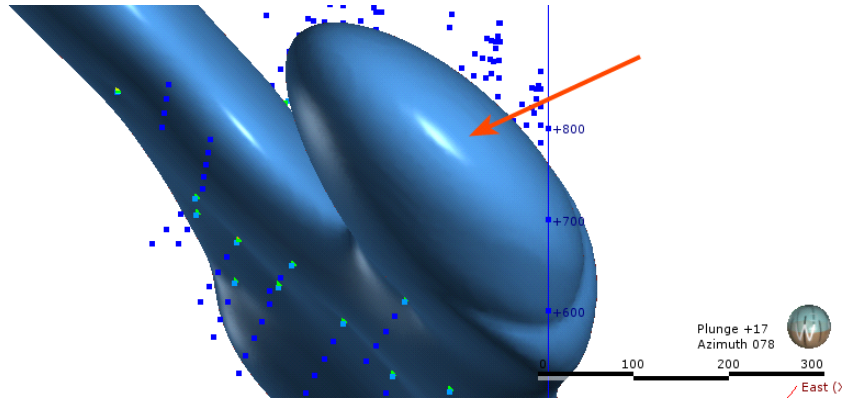

Editing Surfaces with Polylines

In Leapfrog Geothermal, many surfaces can be edited using polylines, including contact surfaces, geological model extents and editable meshes.

To edit a surface with a polyline, it is a good idea to first add the object you wish to edit to the scene and draw a slice across the scene where you plan to edit the surface. Next, right-click on the surface in the project tree and select **Edit > With Polyline**.

The drawing toolbar will appear for the type of polyline selected and a new polyline will be added to the scene. Draw the polyline and adjust it as described in [Drawing in the Scene](#), then click the **Save** button (📁) to view the effect of the polyline on the surface. To remove the polyline from the surface, expand the surface in the project tree. Right-click on the polyline object and select **Remove**.

In cases where you have existing polyline edits (control points), you can import them and add them to the surface. To do this, import the polylines to the **Polylines** folder, then add them to the surface by right-clicking on the surface and selecting **Add > Polyline**.

How a polyline can be used to edit a surface can be illustrated by the following surface, where a small volume is disconnected from the main surface:

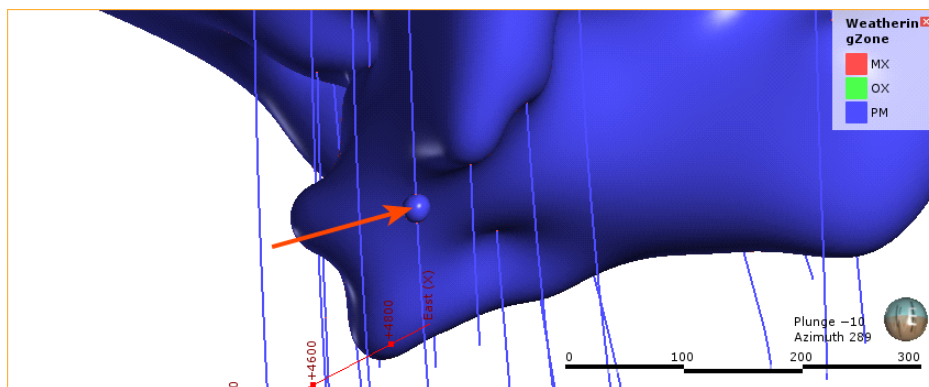

First, a slice is drawn through the surface where it will be edited:

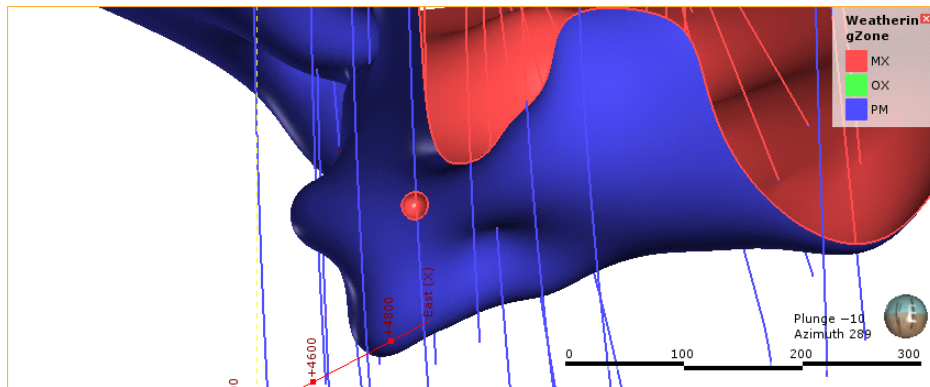

Next, a polyline is created, using two lines to represent contacts that link up the surfaces:

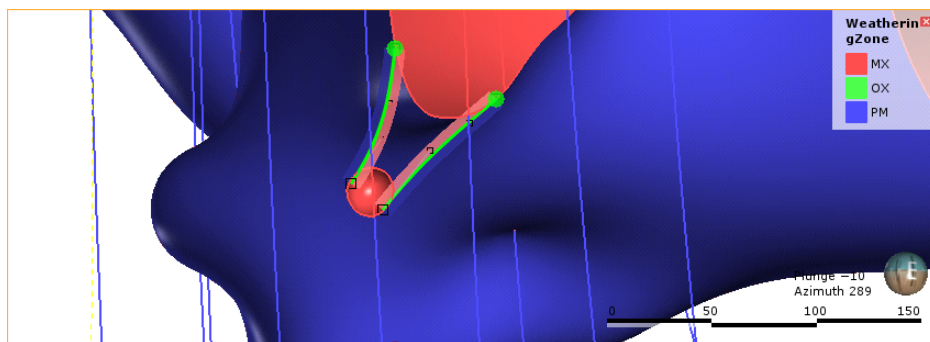

When the polyline edits are saved, the surface is updated to reflect the edits:

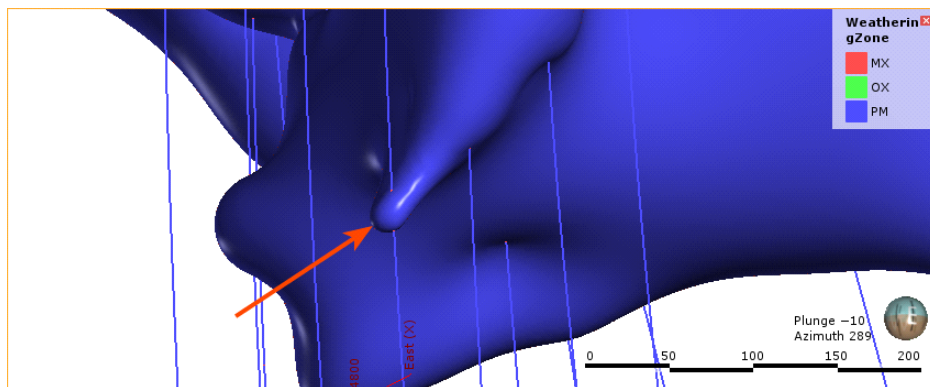

It is best to keep polyline edits to a minimum, as small edits can have significant effects on the shapes of surfaces.

If editing a surface with a polyline results in a distorted surface, use the surface and normal ribbons to check the orientation of the polyline and its segments. See [Tangents and Ribbons](#) for more information.

When you save the polyline, the object will be updated to reflect the additional points. The polyline will be added to the project tree as part of the object that was edited. You can edit the polyline by double-clicking on it or by right-clicking and selecting **Edit Polyline**.

Editing Surfaces with Structural Data

In Leapfrog Geothermal, many surfaces can be edited using planar structural data points drawn in the scene. Surfaces that can be edited in this way include contact surfaces, model extents and interpolated editable meshes. There are two ways to do this:

- If you have a structural data table created in or imported into Leapfrog Geothermal that you want to use to adjust the surface, right-click on the surface in the project tree and select **Add > Structural Data**. You will be prompted to select from the structural data tables available in the project.
- If you want to create structural data points to use to adjust the surface, right-click on the surface in the project tree and select **Edit > With Structural Data**.

To edit a surface with structural data using the second option, it is a good idea to first add the object you wish to edit to the scene. Next, right-click on the surface in the project tree and select the **Edit > With Structural Data** option.

The structural data toolbar will appear and a new structural data object will be added to the scene. Draw the structural data points and adjust them as described in [Creating New Planar Structural Data Tables](#), then click the **Save** button (📁) to view the effect on the surface. Structural data tables created in this way cannot be used by other objects in the project until the table has been shared. To do this, right-click on the table in the project tree and select **Share**. The structural data table will be saved to the **Structural Modelling** folder.

To remove the structural data from the surface, expand the surface in the project tree. Right-click on the structural data object and select **Remove**.

Non-Editable Meshes

Leapfrog Geothermal provides you with several tools for creating non-editable meshes:

- [Mesh from the Moving Plane](#)
- [Combining Meshes](#)
- [Clipping a Volume](#)
- [Clipping a Mesh](#)
- [Extracting Mesh Parts](#)

These tools produce non-editable meshes (🗑️).

Mesh from the Moving Plane

When a vertical wall, flat fault plane or other flat geological surface is required, the moving plane can be used to create a simple mesh.

To create a new mesh from the moving plane, first display the plane in the scene by clicking on the **Show Plane** button (📄). Use the controls in the scene to position the plane, then right-click on the **Meshes** folder and select **Mesh From Moving Plane**. The **Mesh From Plane** window will appear:

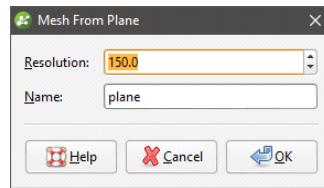

Set the **Resolution** for the mesh, enter a name and click **OK**. The new mesh will appear in the **Meshes** folder.

See [Surface Resolution in Leapfrog Geothermal](#) for more information on the resolution setting.

Combining Meshes

To create a new mesh from two existing closed meshes, right-click on the **Meshes** folder and select **Mesh Operations > Boolean Volume**. The **Boolean Volume** window will appear:

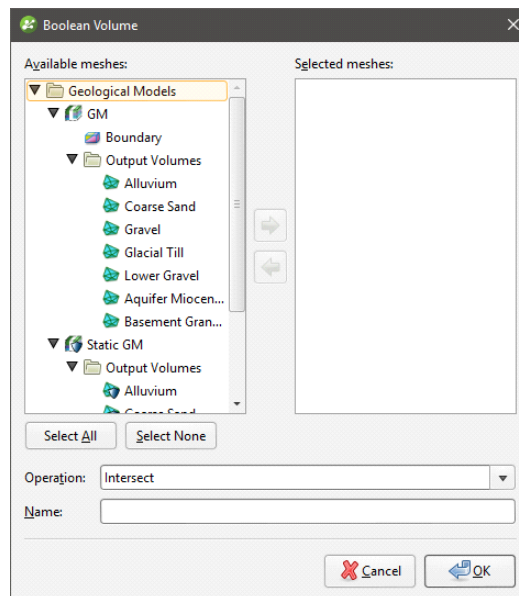

The **Available** list shows all closed meshes available in the project. Select a mesh by double-clicking on it or by clicking on it, then on the arrow.

The **Operation** type can be **Intersect** or **Union**.

Click **OK** to save the new mesh, which will appear in the **Meshes** folder. To edit the mesh, double-click on it. The **Boolean Volume** window will appear.

When any of the meshes used to create the volume is modified, the volume will be updated.

Clipping a Volume

To clip a closed mesh using another mesh, right-click on the **Meshes** folder and select **Mesh Operations > Clip Volume**. The **Clip Volume** window will appear. Select the meshes you wish

to use and whether to retain the inside or outside of the clipped mesh.

Click **OK** to save the new mesh, which will appear in the **Meshes** folder. To edit the mesh, double-click on it.

When either of the meshes used to create the clipped volume is modified, the clipped volume will also be updated.

Clipping a Mesh

This option creates a new mesh that consists of the parts of a **Clip** mesh that are inside, outside or overlap with the **Using** mesh. To clip one mesh using another mesh or boundary in this manner, right-click on the **Meshes** folder and select **Mesh Operations > Clip Mesh**. The **Clip Mesh** window will appear:

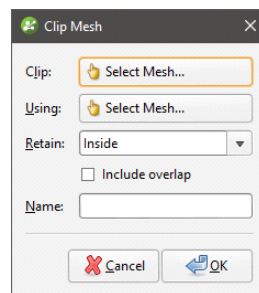

Select the meshes to use, then choose whether to retain the inside or the outside of the clipped mesh. Tick the **Include overlap** box to include the overlap between the two meshes as part of the new mesh.

Click **OK** to save the new mesh, which will appear in the **Meshes** folder. To edit the mesh, double-click on it. The **Clip Mesh** window will appear.

When either of the meshes used to create the clipped mesh is modified, the clipped mesh will be updated.

Extracting Mesh Parts

To extract the triangles from a mesh and create a new mesh, right-click on the surface and select **Extract Mesh Parts**. The **Extract Mesh Parts** window will appear:

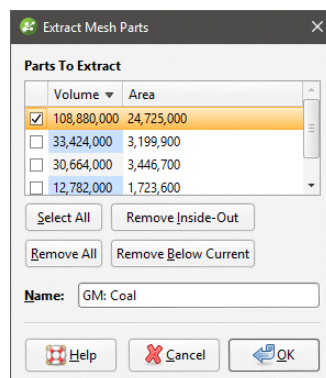

The **Extract clipped mesh** option is only available for meshes that are clipped to a boundary. The largest part is initially selected. You can sort the mesh parts by **Volume** or by **Area** by clicking the heading of the respective column. Other options are:

- Select all parts by clicking the **Select All** button. To de-select all parts click the **Remove All** button.
- Inside-out parts have negative volume. To remove them, click the **Remove Inside-Out** button.
- To remove parts smaller than a given size, first click the **Select All** button. Select the last item you want to keep and click the **Remove Below Current** button.

Click **OK** to save the new mesh, which will appear in the **Meshes** folder. The mesh generated is a non-editable mesh (🔒).

Meshes created in this way are not connected to the mesh they were created from. Changes to the original mesh will not be reflected in the selected parts.

If the quality of the mesh produced is not acceptable, clip the mesh as described in [Clipping a Mesh](#).

Interpolated Meshes

An interpolated mesh is a type of editable mesh (🌐). An interpolated mesh uses FastRBF to fit and interpolate surface data. The FastRBF is useful for creating meshes from sparse datasets or when data has large areas where there are no points. Interpolated meshes can be created from points data, GIS data, polylines, structural data and values objects.

Interpolated meshes can be edited by adding more data to the mesh and changing settings.

This topic describes creating and working with interpolated meshes. It is divided into:

- [Creating an Interpolated Mesh](#)
- [Refining an Interpolated Mesh](#)
 - [Surface Resolution Settings](#)
 - [Snap Settings](#)
 - [Other Options](#)

Creating an Interpolated Mesh

The steps for creating a mesh from data in the project are similar, regardless of the data used to create the mesh. The exceptions are creating an offset mesh and creating a mesh from a thickness map. See [Offset Meshes](#) and [Mesh From Thickness Values](#) for more information.

To create an interpolated mesh from data in the project, right-click on the **Meshes** folder and select from the **New Mesh** options.

Here, a new mesh is being created from points:

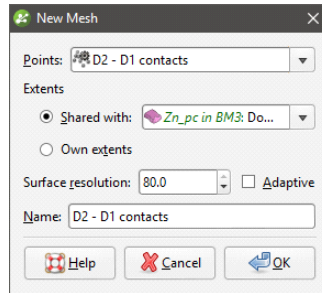

Select the required object from the list.

When defining the mesh's extents, you can set the extents to be independent of other objects in the project (**Own extents**) or you can use the extents of another object (**Shared with**). When you select the **Shared with** option, the mesh will be updated when the extents object it shares is updated.

Leapfrog Geothermal automatically sets the surface resolution based on the data available in the project. You can experiment with the surface resolution and adaptive settings once you have created the mesh. See [Surface Resolution in Leapfrog Geothermal](#) for more information on the effects of these settings.

Enter a name for the new mesh and click **OK**.

If you are creating the mesh from a polyline, you will be prompted to select an existing polyline or draw a new one. If you draw a new polyline, it will not be able to be used elsewhere in the project unless it has been shared. To share the polyline, expand the mesh in the project tree, right-click on the polyline and select **Share**.

The new mesh will appear in the **Meshes** folder. Expand the mesh in the project tree to see how it was made. As further refinements are made to the mesh, that information will also be added to the mesh in the project tree.

Refining an Interpolated Mesh

Editable interpolated meshes (🔗) can be refined by adding data, as described in [Adding Data to Surfaces](#). The options available depend on how the mesh was created.

To add data to an editable mesh, right-click on it and select one of the options from the **Add** menu. A list of objects available in the project will be displayed. Select the required object and click **OK**. The mesh will be updated and the object used to modify it will appear under it in the project tree.

You can also refine editable interpolated meshes by changing the trend, transforming values, adjusting the interpolant and changing the boundary. To do this, double-click on the mesh. The **Edit Mesh** window will be opened:

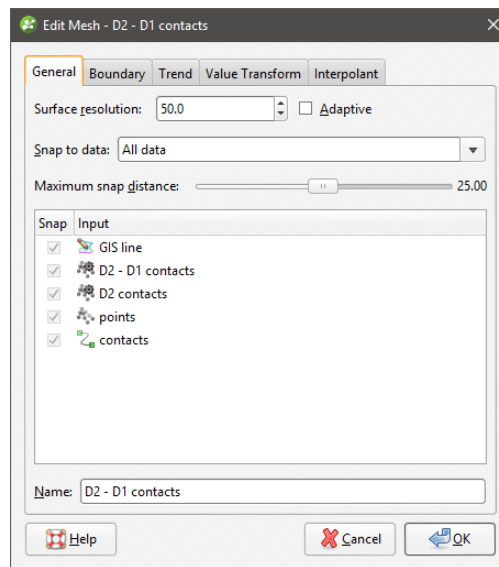

See [Offset Meshes](#) for the options available for meshes from offset points.

Surface Resolution Settings

See [Surface Resolution in Leapfrog Geothermal](#) for more information on the **Surface resolution** settings in the **General** tab.

Snap Settings

The mesh can be set to snap to the data objects used to create it. There are four options:

- **Off.** The mesh does not snap to the data.
- **All data.** The mesh snaps to data within the **Maximum snap distance**.
- **Drilling only.** The mesh snaps only to well data and data objects derived from well data within the **Maximum snap distance** but not to other data. For example, the mesh will honour points data derived from well data, but not points data imported into the **Points** folder.
- **Custom.** The mesh snaps to selected data objects within the **Maximum snap distance**.

Take care in enabling snapping and in selecting what data the surface will snap to, as the more data you include, e.g. by setting a large **Maximum snap distance** or selecting **All data** for **Snap to data**, the greater the possibility that errors in the data or assumptions inherent in interpretations (e.g. polylines) will cause distortions in the meshes. If you do enable snapping, it is best to snap only to drilling data. See [Honouring Surface Contacts](#) for more information on these settings.

When **Snap to data** is set to **Custom**, you can then set whether or not **Snap** is enabled for the objects used to create the mesh, as discussed in [Honouring Surface Contacts](#). **Custom** is the most flexible options as you can select the specific data objects the mesh will or will not snap to. If you will be exporting the mesh for use in another application, you may wish to adjust the snap settings.

Data used to create the mesh will appear in the **Input** list. When you add more data to the mesh, those objects will also be listed. You can remove those additional objects by expanding the mesh in the project tree, then right-clicking on the data object and selecting **Remove**.

Other Options

In the **Boundary** tab, you can change whether the mesh boundary is independent of other objects in the project (**Own extents**) or you can use the extents of another object (**Shared with**). When you select the **Shared with** option, the mesh will be updated when the extents object it shares is updated.

Options available in other tabs are similar to those available for interpolants. See:

- [Structural Trends](#)
- [Clipping and Transforming Values for an RBF Interpolant](#)

For information on the parameters in the **Interpolants** tab, see:

- [Interpolant Functions](#)
- [The Spheroidal Interpolant Function](#)
- [The Linear Interpolant Function](#)

Offset Meshes

You can create a new interpolated mesh by offsetting an existing mesh with any points object in the project. To do this, first ensure the points and mesh you wish to use are already in the project. Next, right-click on the **Meshes** folder and select **New Mesh > From Offset Points**. In the window that appears, select the **Mesh** and **Points** to use:

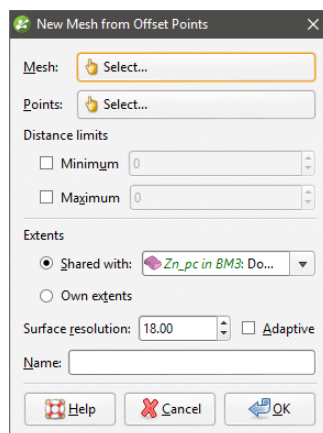

When the mesh is created, it will automatically snap to the points, and points outside the **Distance Limits** will be ignored. These settings can be changed once the mesh has been created.

An offset mesh may be distorted if points used to offset the mesh lie too far outside the mesh extents. If this occurs, set a **Maximum** distance to exclude points far away from the mesh extents.

Enter a name for the new mesh and click **OK**. The new mesh will appear in the **Meshes** folder. To edit the mesh, double-click on it. The **Edit Offset Mesh** window will appear:

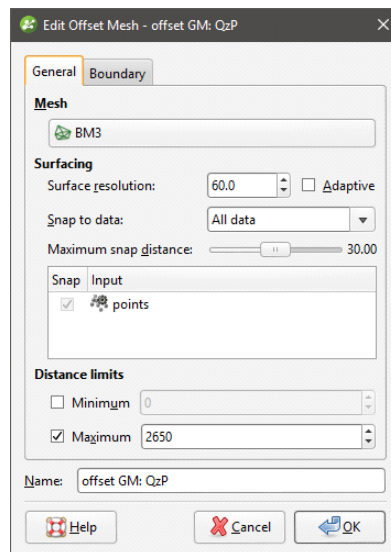

The mesh can be set to snap to the data objects used to create it. There are four options:

- **Off**. The mesh does not snap to the data.
- **All data**. The mesh snaps to data within the **Maximum snap distance**.
- **Drilling only**. The mesh snaps only to well data and data objects derived from well data within the **Maximum snap distance** but not to other data. For example, the mesh will honour points data derived from well data, but not points data imported into the **Points** folder.
- **Custom**. The mesh snaps to selected data objects within the **Maximum snap distance**.

Take care in enabling snapping and in selecting what data the surface will snap to, as the more data you include, e.g. by setting a large **Maximum snap distance** or selecting **All data** for **Snap to data**, the greater the possibility that errors in the data or assumptions inherent in interpretations (e.g. polylines) will cause distortions in the meshes. If you do enable snapping, it is best to snap only to drilling data. See [Honouring Surface Contacts](#) for more information on these settings.

When **Snap to data** is set to **Custom**, you can then set whether or not **Snap** is enabled for the objects used to create the mesh, as discussed in [Honouring Surface Contacts](#). **Custom** is the most flexible options as you can select the specific data objects the mesh will or will not snap to. If you will be exporting the mesh for use in another application, you may wish to adjust the snap settings.

Data used to create the mesh will appear in the **Input** list. When you add more data to the mesh, those objects will also be listed. You can remove those additional objects by expanding the mesh in the project tree, then right-clicking on the data object and selecting **Remove**.

You can modify an offset mesh by adding data, as described in [Refining an Interpolated Mesh](#).

It is not possible to add structural data or polylines with orientation information to an offset mesh. If you edit an offset mesh with a polyline, your options for editing the polyline will be limited.

You can also edit the mesh's boundary, but you cannot apply a trend, clip and transform values or adjust the interpolant as you can for other interpolated editable meshes.

Triangulated Meshes

A triangulated mesh is a type of editable mesh (🌐). A triangulated mesh uses Delaunay triangulation to create the mesh and can handle more points than an interpolated mesh. Triangulated meshes can be created from points data, GIS data and polylines. Large datasets representing horizontal surfaces can be used to create a triangulated mesh.

The steps for creating a mesh from data in the project are similar, regardless of the data used to create the mesh. To create a triangulated mesh from data in the project, right-click on the **Meshes** folder and select from the **New Triangulated Mesh** options.

Here, a new triangulated mesh is being created from points:

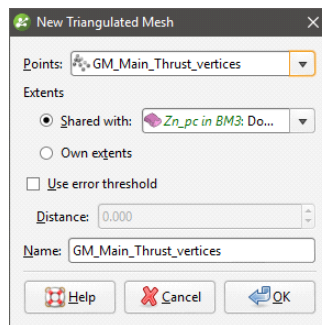

Select the required object from the list.

When defining the mesh's extents, you can set the extents to be independent of other objects in the project (**Own extents**) or you can use the extents of another object (**Shared with**). When you select the **Shared with** option, the mesh will be updated when the extents object it shares is updated.

The **Use error threshold** setting lets you exclude data points that fall within the threshold. This can be useful if you are using a large dataset and you require a more coarse surface that omits some data. When **Use error threshold** is disabled, the mesh will follow all the data.

Here, a mesh created from points has the **Use error threshold** disabled. The mesh follows all the points:

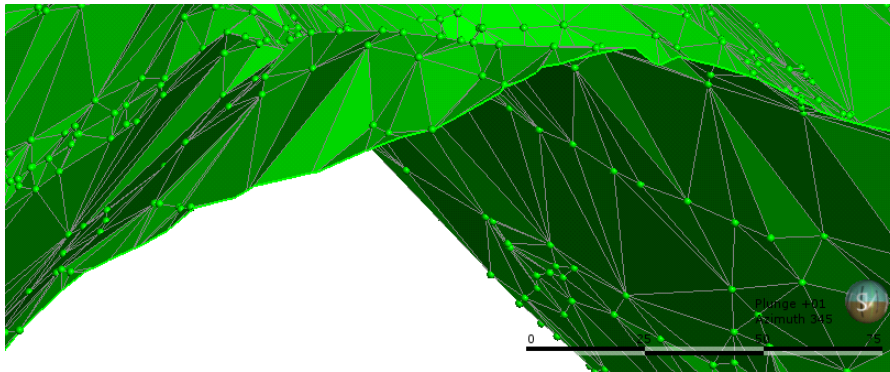

Here, a mesh has been created with the **Distance** set to 20. The mesh ignores points that fall outside the threshold:

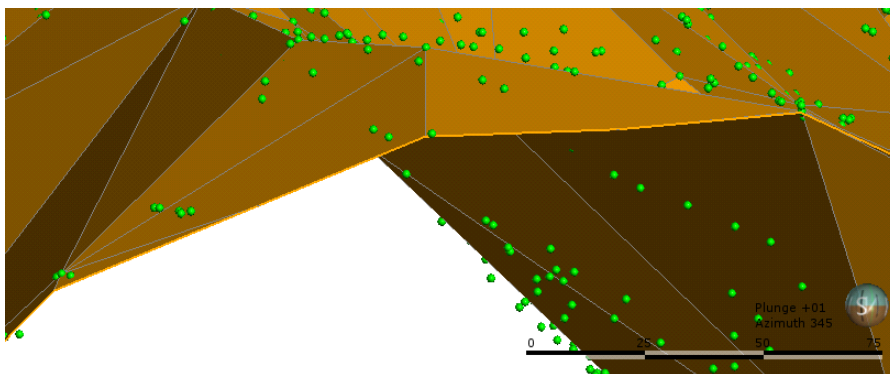

You will be able to change the **Use error threshold** setting once the mesh has been created. Enter a name for the new mesh and click **OK**.

If you are creating the mesh from a polyline, you will be prompted to select an existing polyline or draw a new one. If you draw a new polyline, it will not be able to be used elsewhere in the project unless it has been shared. To share the polyline, expand the mesh in the project tree, right-click on the polyline and select **Share**.

The new mesh will appear in the **Meshes** folder and you can edit its settings by double-clicking on it.

To add data to a triangulated mesh, right-click on it and select one of the options from the **Add** menu. A list of objects available in the project will be displayed. Select the required object and click **OK**. The mesh will be updated and the object used to modify it will appear under it in the project tree.

It is not possible to add structural data or polylines with orientation information to a triangulated mesh. If you edit a triangulated mesh with a polyline, your options for editing the polyline will be limited.

Mesh From Thickness Values

A mesh can be created from a base mesh and a set of thickness values. Thickness data can be imported as values on GIS points, as a 2D grid or as points with values. Once you have this data in the project, right-click on the **Meshes** folder and select **New Mesh > From Thickness Values**.

Select the **Base mesh** and the **Thickness values**. Here the base mesh has been created from a set of points and the thickness values are a set of values on GIS points:

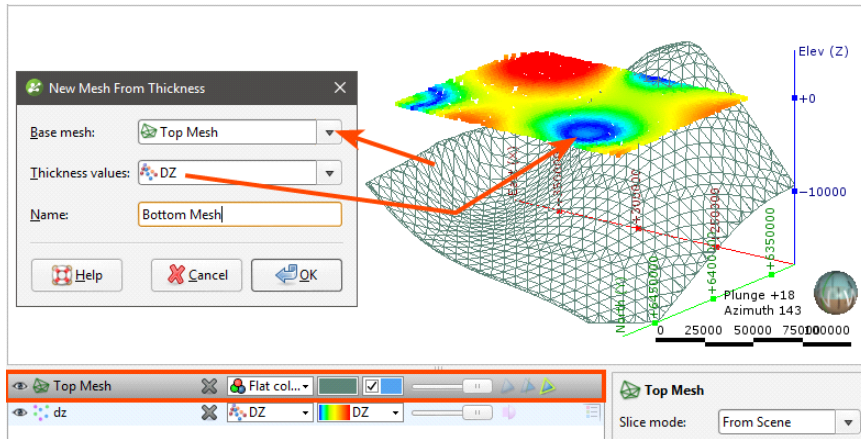

The bottom surface (yellow) has the same X and Y values as the top surface (blue); only the Z values vary:

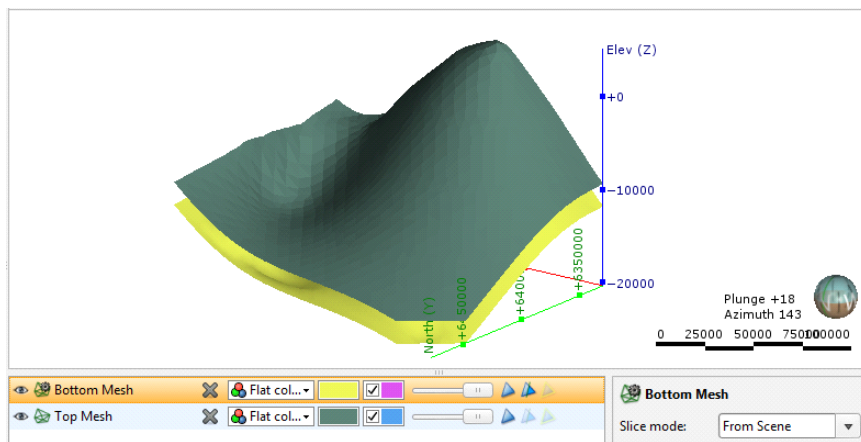

To edit a mesh created from thickness values, double-click on it in the project tree.

Elevation Grids

Leapfrog Geothermal imports and exports elevation grids in common formats.

Importing an Elevation Grid

Elevation grid formats Leapfrog Geothermal supports include:

- Arc/Info ASCII Grid Files (*.asc, *.txt)
- Arc/Info Binary Grid Files (*.adf)
- Digital Elevation Model Files (*.dem)
- Surfer ASCII or Binary Grid Files (*.grd)
- SRTM Files (*.hgt)
- ESRI.hdr Labelled Image Files (*.img, *.bil)
- GeoTIFF Image Files (*.tiff, *.tif)

There are two ways to import an elevation grid:

- Import the grid to the **Meshes** folder. Right-click on the **Meshes** folder and select **Import Elevation Grid**.
- Import the grid as part of creating a topography. Right-click on the **Topographies** folder and select **New Topography > Import Elevation Grid**.

Navigate to the folder that contains the elevation grid file and open the file. The **Import Elevation Grid** window will be displayed:

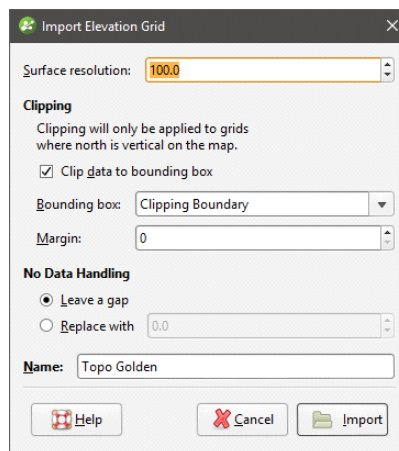

Leapfrog Geothermal automatically sets a **Surface resolution** based on the information in the file, but you can change the value if you wish. A lower value will produce more detail, but calculations will take longer. See [Surface Resolution in Leapfrog Geothermal](#) for more information.

When importing an elevation grid, note that the resolution cannot be changed once the file has been imported.

Data is automatically clipped to the clipping boundary, but you can change how the data is filtered to suit any bounding box that exists in the project. If you do not wish to clip the data, untick **Clip data to bounding box**.

The **Margin** value determines how far outside the selected **Bounding box** the elevation grid will extend.

The **No Data Handling** option determines whether NoData values are displayed as gaps or at a fixed elevation setting.

Click **Import**. If you are creating a new topography, you will then be prompted to enter a name for it and click **OK**.

The elevation grid will be added to the **Meshes** folder. If you imported the grid as part of creating a topography, a hyperlink to the grid in the **Meshes** folder will appear as part of the defined topography.

Exporting an Elevation Grid

For any mesh in a project, you can export an elevation grid for use in other software. Formats Leapfrog Geothermal can export are:

- ARC/Info ASCII Grid (*.asc)
- ESRI.hdr Labelled (*.bil)
- ENVI Raster Image (*.img)
- Surfer ASCII Grid (*.grd)

To export an elevation grid, right-click on the mesh and select **Export Elevation Grid**. The **Export Grid** window will appear:

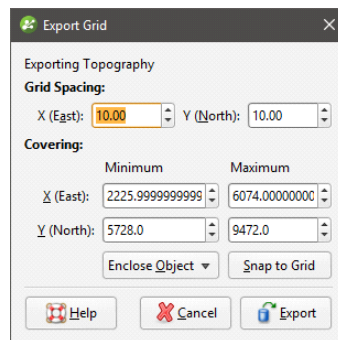

The **Snap to Grid** option changes the extents of the exported grid so that they coincide with the elevation grid spacing.

Enter the information required, then click **Export** to enter a filename and choose a location and format for the file.

Thickness Grids

For any mesh in a project, you can export a grid made up of the area between two surfaces. Formats Leapfrog Geothermal can export are:

- ARC/Info ASCII Grid (*.asc)
- ESRI.hdr Labelled (*.bil)

- ENVI Raster Image (*.img)
- Surfer ASCII Grid (*.grd)

To export a thickness grid, right-click on the mesh and select **Export Thickness Grid**. The **Export Thickness Grid** window will appear:

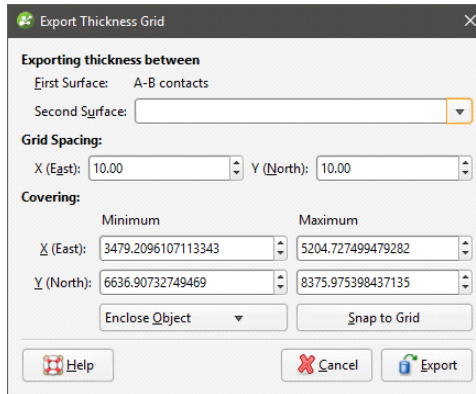

Select the surfaces required from the lists.

Enter the information required, then click **Export**. You will be prompted for a filename and location.

Polylines

Leapfrog Geothermal imports many common polyline formats and also has tools for drawing and exporting polylines. This topic describes:

- [Creating Polylines](#)
- [Displaying Polylines](#)
- [Sharing and Unsharing Polylines](#)
- [Importing Polylines](#)
- [Reloading Polylines](#)
- [Exporting Polylines](#)

See [Drawing in the Scene](#) for information on drawing and editing polylines.

Creating Polylines

There are three ways to create polylines in Leapfrog Geothermal:

- Create a new polyline using the **Polylines** folder. These polylines are stored in the **Polylines** folder.
- Create a new polyline as part of working with another tool. For example, a polyline can be drawn to create a lateral extent in a geological model. These polylines are stored in the tool used to create them and cannot be used elsewhere in the project unless they have been shared. To share a polyline, right-click on it and select **Share**. The polyline will be moved to the **Polylines** folder and can be used elsewhere in the project.
- Create a new polyline from a GIS line. To do this, right-click on the GIS lines object (🗺️ or 📷) in the **GIS Data, Maps and Photos** folder and select **Extract Polyline**. The new polyline object will appear in the **Polylines** folder. It is not linked to the original GIS lines object.

See [Drawing in the Scene](#) for information on drawing and editing polylines.

Displaying Polylines

When polylines are displayed in the scene, you can control the colour of the positive and negative surfaces of the line and of the line itself. In this example, the positive side of the polyline is red, the negative side is blue and the polyline itself is green:

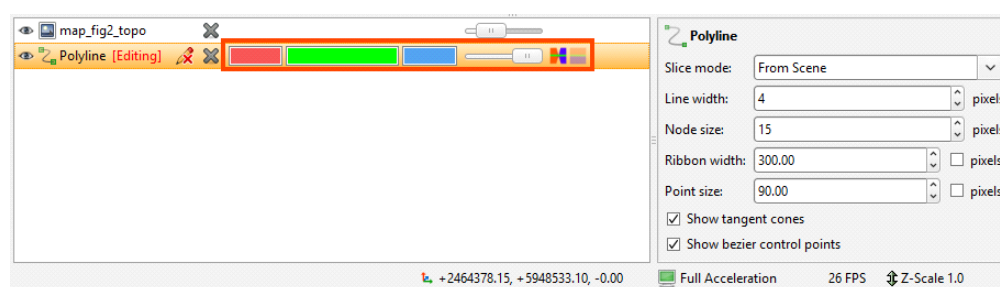

For contact surfaces, the colour of the positive and negative sides of a ribbon will be determined by the lithologies or categories assigned to either side of the surface.

With the **Node size** and **Point size** controls in the properties panel, you can change the size of nodes and points in the scene to make working with the polyline easier.

Polylines have a **Surface ribbon** (🚩) and **Normal ribbon** (🚩) to help you to determine the orientation of the polyline in the scene. The surface ribbon reflects the orientation of the polyline and the normal ribbon is perpendicular to the surface ribbon. For example, click on the **Surface ribbon** button (🚩) to determine which side of the polyline is positive (red) and which side is negative (blue):

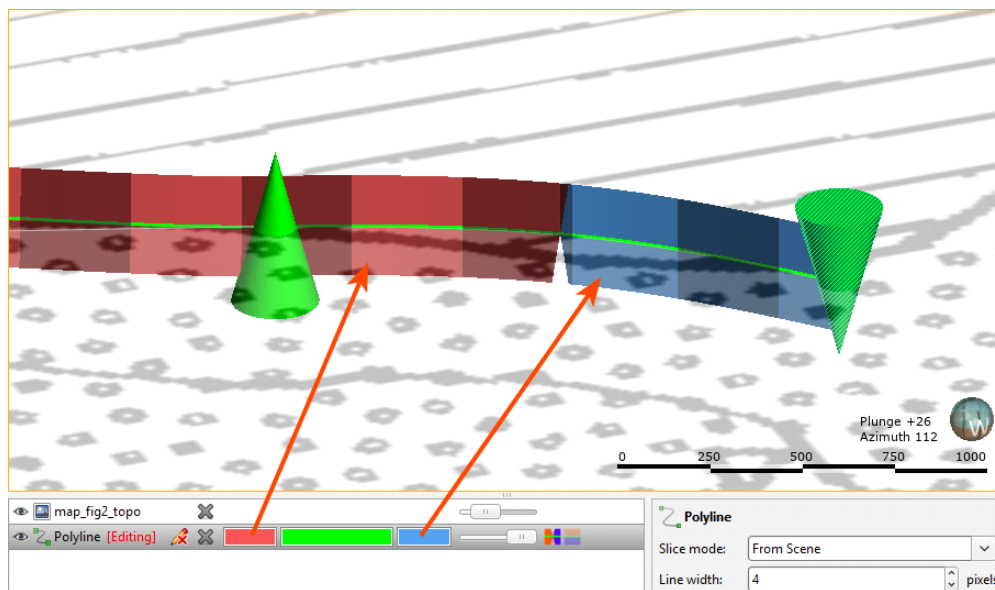

If you are having trouble seeing the ribbons, you can change their size using the **Ribbon width** control in the properties panel.

Other aspects of polyline display are useful when creating and editing polylines. See [Drawing in the Scene](#).

Sharing and Unsharing Polylines

Some polylines are created as part of working with other objects and are not available elsewhere in the project. An example of this is a polyline drawn as part of creating a model boundary. To share the polyline, right-click on the object in the project tree and click **Share**. The shared polyline will be copied to the relevant location in the project tree and a hyperlink added to the object it was shared from.

Polylines that have been shared can be unshared by making a local copy of the polyline. To do this, right-click on the shared polyline and select **Create Local Copy**:

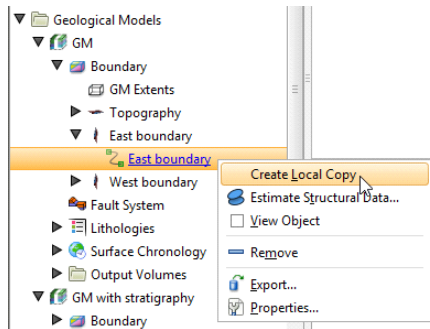

The polyline in the **Polylines** folder remains, but a local copy of it is made and the hyperlink to the **Polylines** folder copy is deleted. This means you can now work on, for example, the **Polylines** folder copy without changes to it affecting the geological model's copy.

Importing Polylines

Polyline formats Leapfrog Geothermal supports include:

- Datamine Polylines (*.asc)
- Surpac String Polylines (*.str)
- Gemcom Polylines (*.asc)
- Micromine Polylines (*.str, *.asc)
- MineSight Polylines (*.srg)
- Gocad Polylines (*.pl, *.ts)
- Drawing Interchange Polylines (*.dxf)
- Leapfrog Polylines (*.lfpl)
- Leapfrog Polylines (*.csv, *.txt)

There are two ways to import a polyline:

- Right-click on the **Polylines** folder and select **Import Polyline**. In the **Import Polyline** window, navigate to the location where the polyline file is saved and select it. Click **Open**.
- Drag and drop polyline files directly into Leapfrog Geothermal.

If the polyline file is in Leapfrog, Gocad or DXF formats, the importing will start immediately. For all other formats, the **Polyline Import** window will appear. If the polyline file is in one of the standard formats listed above, the default settings can be used. Click **Import** to finish the process. If, however, you wish to specify polyline import parameters, two pieces of information are required:

- The columns the polyline vertex coordinates are in
- How the polyline sections are separated in the file

Select the vertex coordinate columns by clicking on the heading at the top of a column and selecting one of East (X), North (Y) or Elev (Z) from the list.

When importing a file that has multiple features, you will be prompted to select which ones to import. You can also choose to:

- Import the features as separate objects. Each feature will appear in the project tree as a separate object.
- Flatten all features into one object. Leapfrog Geothermal will treat all features as a single object.

The polyline will be imported and added to the project tree under the **Polylines** folder.

See [Drawing in the Scene](#) for information on drawing and editing polylines.

Reloading Polylines

Reloading data is necessary when the imported data is modified externally. To reload a polyline, right-click on it in the project tree and select **Reload Data**.

Reloading a polyline overwrites any changes you have made to the polyline. Any dependent objects will be updated, which can take some time.

Select the file to be reloaded and click **Open**. The polyline will be updated, as will any dependent objects.

Exporting Polylines

Export a polyline by right-clicking on it and selecting **Export**. Leapfrog Geothermal exports polylines in the following formats:

- Leapfrog Polylines (*.lfpl)
- Leapfrog Polylines (*.csv)
- Drawing Interchange Polylines (*.dxf)
- Surpac String Polylines (*.str)
- Gocad Polylines (*.pl, *.ts)
- MineSight Polylines (*.srg)
- Datamine Polylines (*.asc)
- Micromine Polylines (*.str, *.asc)
- Drawing File (2013/LT2013) (*.dwg)
- Bentley Drawing Files (v8) (*.dgn)

Analysing Data

Leapfrog Geothermal has a number of tools that help you to analyse your data.

- The most basic information about an object is contained in the object's **Properties** window, which is specific to the type of object. Right-click on the object in the project tree and select **Properties**. See [Object Properties](#) in the [The Project Tree](#) topic for more information.
- Viewing statistical information about objects helps you to analyse your data. This is described further below.
- Visualising data using the shape list and the shape properties panel is an important part of interpreting and refining data and making modelling decisions. The tools available depend on the type of object being displayed, and many objects can be displayed evaluated on other objects.
- Stereonets are useful for visualising structural data and identifying trends in 2D. Errors in categorisation of structural data can also become apparent when the data is viewed on a stereonet.
- Form interpolants are useful for visualising structural data and identifying broad trends in 3D. The form interpolant's meshes can then be used to control other surfaces in the project.
- With the well correlation tool, you can view and compare selected wells in a 2D view. You can then create interpretation tables in which you can assign and adjust intervals and create new intervals. Interpretation tables are like any other interval table in a project and can be used to create models.
- You can plan wells, view prognoses for models in the project and export planned wells in .csv format.

The rest of this topic describes the different statistics visualisations available in Leapfrog Geothermal.

Statistics

The statistics options available in Leapfrog Geothermal depend on the type of object. Common statistics visualisations are described below:

- [Table of Statistics](#)
- [Scatter Plots](#)
- [Q-Q Plots](#)
- [Box Plots](#)
- [Univariate Graphs](#)

Variations of these are described relative to the data objects for which they are relevant.

Leapfrog Geothermal uses fixed 25%/75% quartiles.

Table of Statistics

For many data tables, you can view a table of statistics for multiple attributes. If the table has one or more category columns, data can, optionally, be grouped by category. To open a table of statistics, right-click on a data table then select **Statistics**. In the window that appears, select the **Table of Statistics** option.

In this example, we have the initial table of statistics for a merged table that has two category columns and four numeric columns, plus an **Interval Length** column. However, nothing is displayed in the table because data columns have not yet been selected.

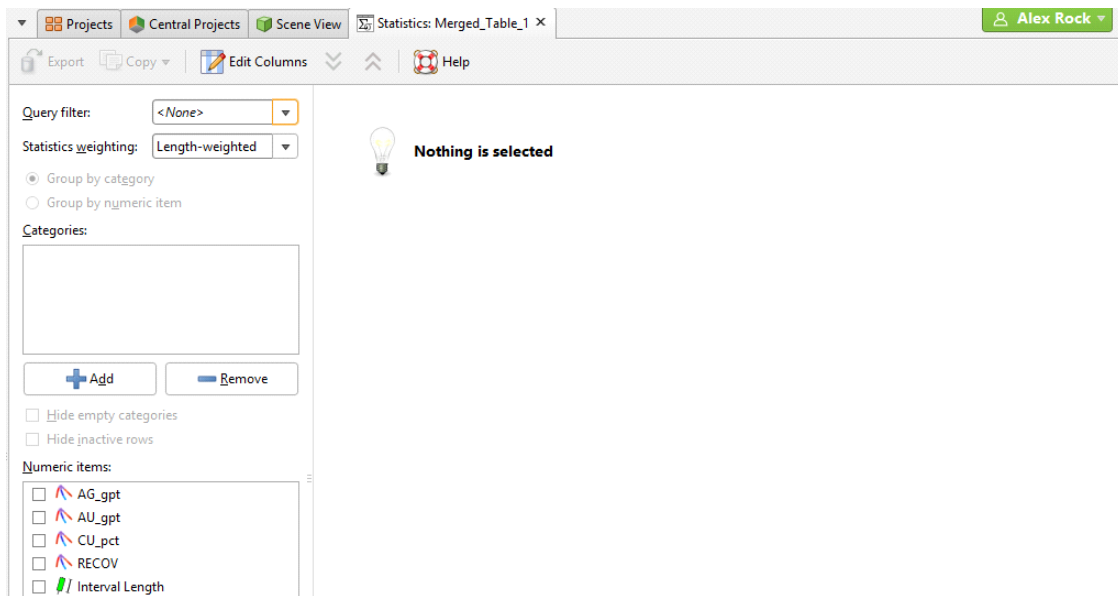

Select from the **Numeric items** available for the table. In this case, all columns have been selected, including the **Interval Length** column:

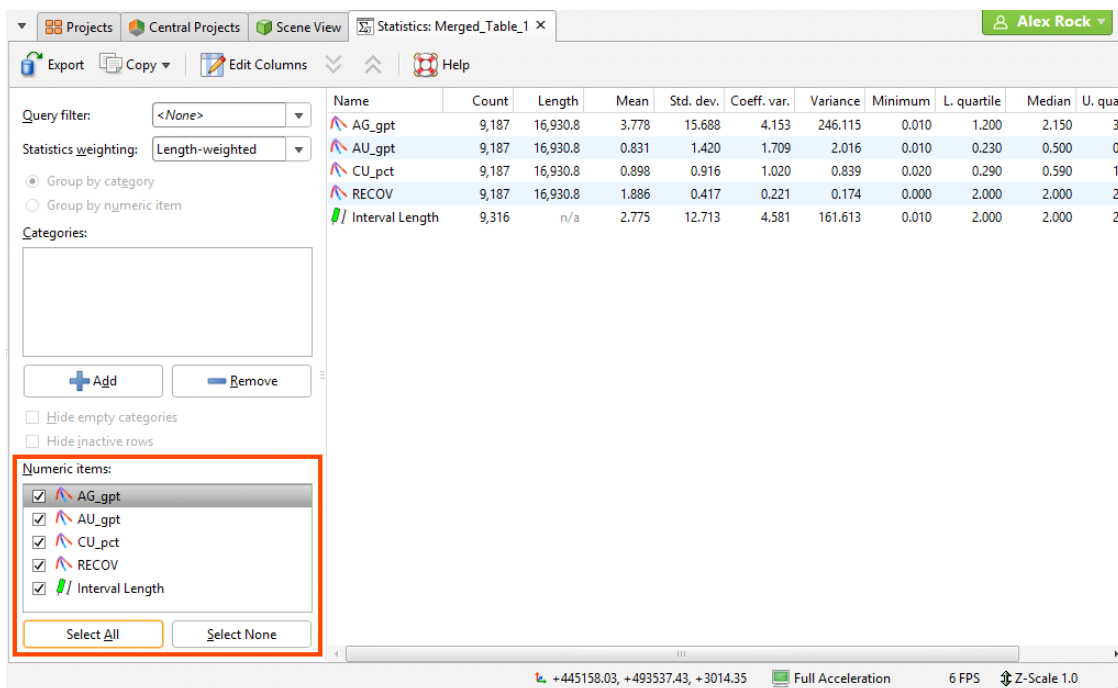

Click the **Add** button to select from the category columns available in the table. An entry will be added to the **Categories** list. Click on the arrow to select from the available category columns:

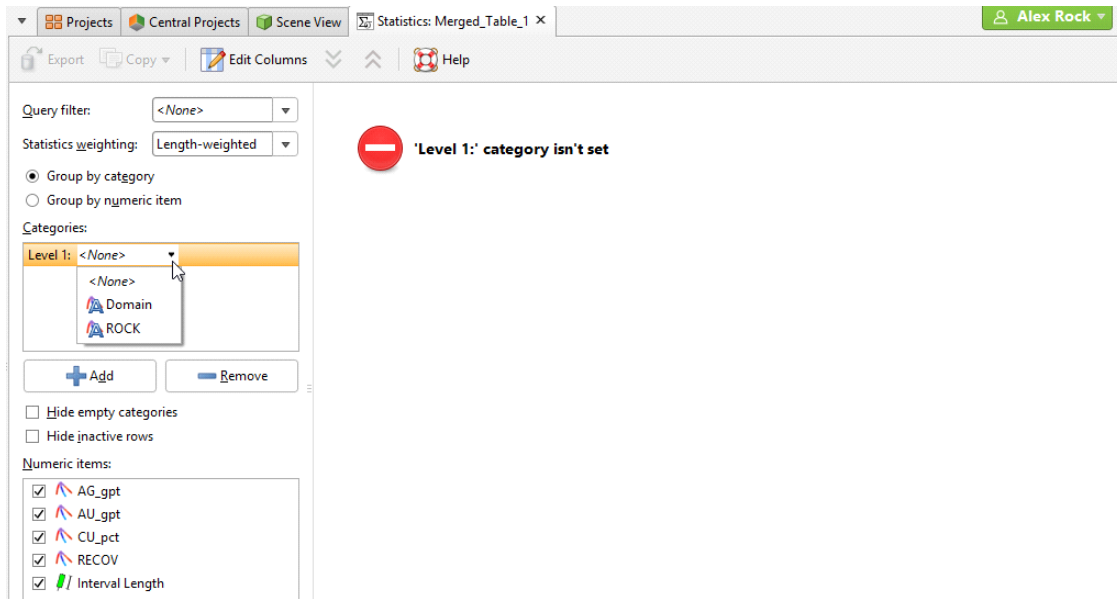

Statistics for the selected category column will be displayed in the table. You can change what categories are displayed by clicking on the second button and enabling or disabling categories:

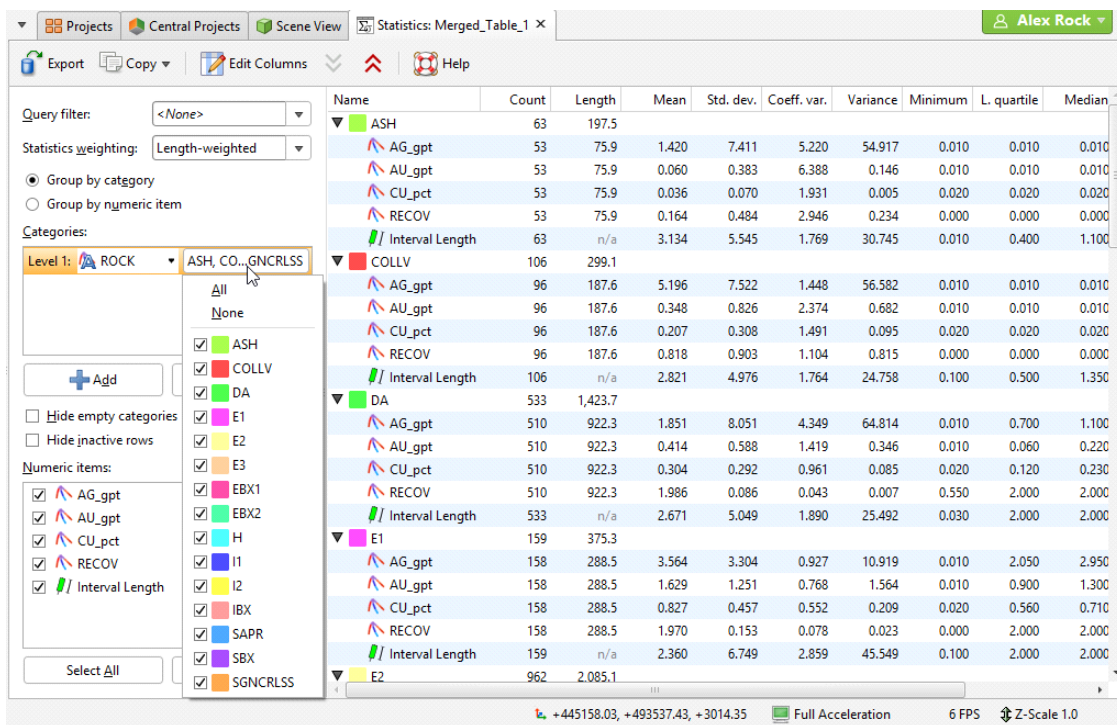

If there is more than one category column, you can set lower levels. Here there are two category columns displayed in the table, "ROCK" and "Domain":

You can hide empty categories (those with a count of zero) and inactive rows using the options below the **Categories** list:

Group by category and **Group by numeric item** provide further options for the table organisation. Here the **Group by numeric item** option has been selected:

Name	Count	Length	Mean	Std. dev.	Coeff. var.	Variance	Minimum	L. quartile	Median
AG_gpt	9,187	16,930.8	3.778	15.688	4.153	246.115	0.010	1.200	2.150
ASH	53	75.9	1.420	7.411	5.220	54.917	0.010	0.010	0.010
COLLV	96	187.6	5.196	7.522	1.448	56.582	0.010	0.010	0.010
DA	510	922.3	1.851	8.051	4.349	64.814	0.010	0.700	1.100
E1	158	288.5	3.564	3.304	0.927	10.919	0.010	2.050	2.950
E2	953	1,752.1	3.164	4.121	1.303	16.983	0.010	1.400	2.150
E3	633	1,166.0	4.360	9.261	2.124	85.770	0.010	1.900	3.000
EBX1	145	277.5	3.595	2.245	0.624	5.039	0.400	2.350	3.150
EBX2	2,035	3,858.9	4.994	23.922	4.790	572.267	0.010	1.800	2.750
H	1,382	2,587.9	2.492	7.944	3.188	63.108	0.010	0.650	1.400
I1	914	1,747.1	3.516	4.368	1.242	19.077	0.010	1.250	2.300
I2	297	552.7	3.156	2.549	0.808	6.499	0.300	1.150	2.450
IBX	1,259	2,456.2	3.308	15.013	4.539	225.380	0.010	1.200	1.800
SAPR	265	429.3	5.808	6.858	1.181	47.032	0.010	1.750	3.750
SBX	176	302.0	6.543	40.991	6.265	1,680.227	0.010	1.050	1.750
SGNCRLSS	266	239.0	8.642	43.383	5.020	1,882.104	0.010	0.010	2.000
*inactive	45	87.6	2.827	3.261	1.154	10.637	0.010	1.050	1.750
AU_gpt	9,187	16,930.8	0.831	1.420	1.709	2.016	0.010	0.230	0.500
ASH	53	75.9	0.060	0.383	6.388	0.146	0.010	0.010	0.010
COLLV	96	187.6	0.348	0.826	2.374	0.682	0.010	0.010	0.010
DA	510	922.3	0.414	0.588	1.419	0.346	0.010	0.060	0.220

You can filter the data using any **Query filter** defined for the data table. Statistics for interval tables can be unweighted or weighted by interval length.

Change the columns displayed in the table by clicking on the **Edit Columns** button:

Column	Count	Length	Mean	Std. dev.	Coeff. var.	Variance	Minimum	L. quartile	Med
Count	63	197.5							
Length	53	75.9	1.420	7.411	5.220	54.917	0.010	0.010	0.010
Mean		75.9	0.060	0.383	6.388	0.146	0.010	0.010	0.010
Standard deviation		75.9	0.036	0.070	1.931	0.005	0.020	0.020	0.020
Coefficient of variation		75.9	0.164	0.484	2.946	0.234	0.000	0.000	0.000
Variance		n/a	3.134	5.545	1.769	30.745	0.010	0.400	1.000
Minimum		38.8							
Lower quartile		38.8	2.644	10.653	4.029	113.484	0.010	0.010	0.010
Median		38.8	0.033	0.113	3.427	0.013	0.010	0.010	0.010
Upper quartile		38.8	0.039	0.065	1.679	0.004	0.020	0.020	0.020
Maximum		38.8	0.271	0.622	2.293	0.387	0.000	0.000	0.000
Count		n/a	1.685	2.522	1.496	6.359	0.010	0.400	0.010
Length		37.2							
Mean		37.2	0.144	0.898	6.255	0.807	0.010	0.010	0.010
Standard deviation		37.2	0.088	0.541	6.151	0.292	0.010	0.010	0.010
Coefficient of variation		37.2	0.034	0.078	2.327	0.006	0.020	0.020	0.020
Variance		37.2	0.052	0.292	5.584	0.086	0.000	0.000	0.000
Minimum		n/a	1.239	1.458	1.177	2.127	0.100	0.350	0.010
Lower quartile		299.1							
Median		187.6	5.196	7.522	1.448	56.582	0.010	0.010	0.010
Upper quartile		187.6	0.348	0.826	2.374	0.682	0.010	0.010	0.010
Maximum		187.6	0.207	0.308	1.491	0.095	0.020	0.020	0.010

Once you have set up a table of statistics on a particular table, its settings will be saved so you can easily review the statistics and export the table using the same settings.

To export the table in CSV format, click on the **Export** button in the toolbar (📄).

Other controls in this window are as follows:

- The arrow buttons at the top of the window (⏴ and ⏵) allow you to quickly expand or collapse the rows.

- Click rows to select them.
- Select multiple rows by holding down the Shift or Ctrl key while clicking rows.
- The **Copy** button (📄) copies the selected rows to the clipboard so you can paste them into another application.

Scatter Plots

Scatter plots are useful for understanding relationships between two variables. An additional variable can be introduced by setting the **Colouring** option to a data column. The example below plots the two variables lead and zinc against each other, with gold being indicated by the colouring. You can make either axis a log scale with the **Log scale in X** and **Log scale in Y** options. A **Query filter** may be applied also.

The appearance of the chart can be modified by adjusting the **Point size**, **Point shape**, and **White background** settings.

Enable **Show X = Y line** to aid in assessing how far off equal the distributions are.

When you select **Show linear regression**, a regression line is added to the chart and a function equation is added below the chart title.

Show conditional expectation plots a line that attempts to find the expected value of one variable given the other. The X axis is divided into a number of bins specified by **Bin count**, and the data in each bin is used to predict the expected Y value.

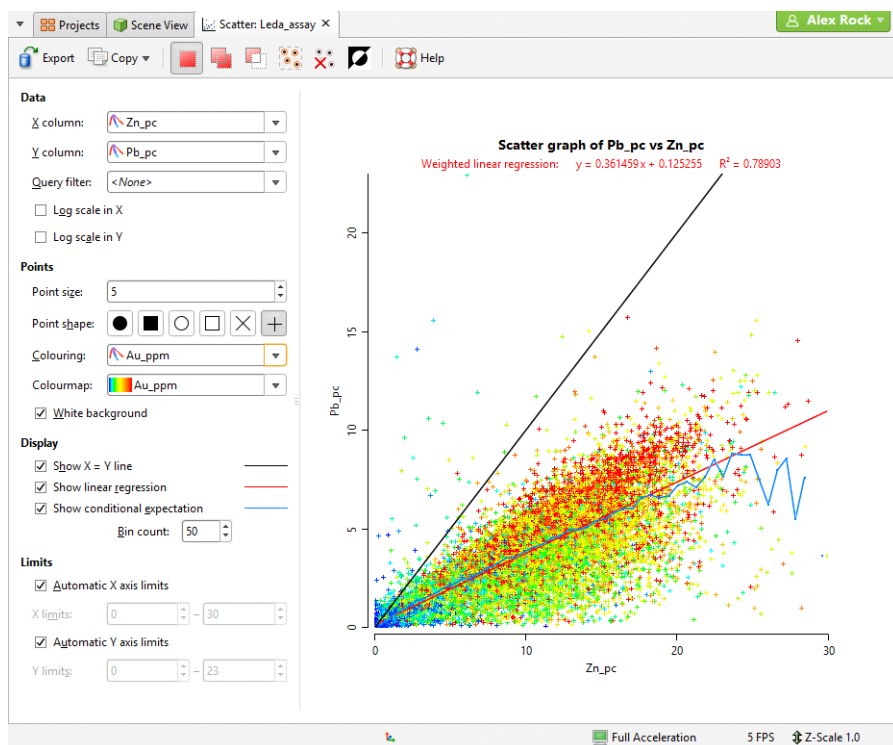

By default, the limits of the chart are automatically set to range between zero and the upper limit of the variable data. You can adjust this by turning off **Automatic X axis limits** and/or **Automatic Y axis limits** and specifying preferred minimum and maximum values for each axis. Select points in the scatter plot by clicking and dragging your mouse pointer to draw freehand around the points.

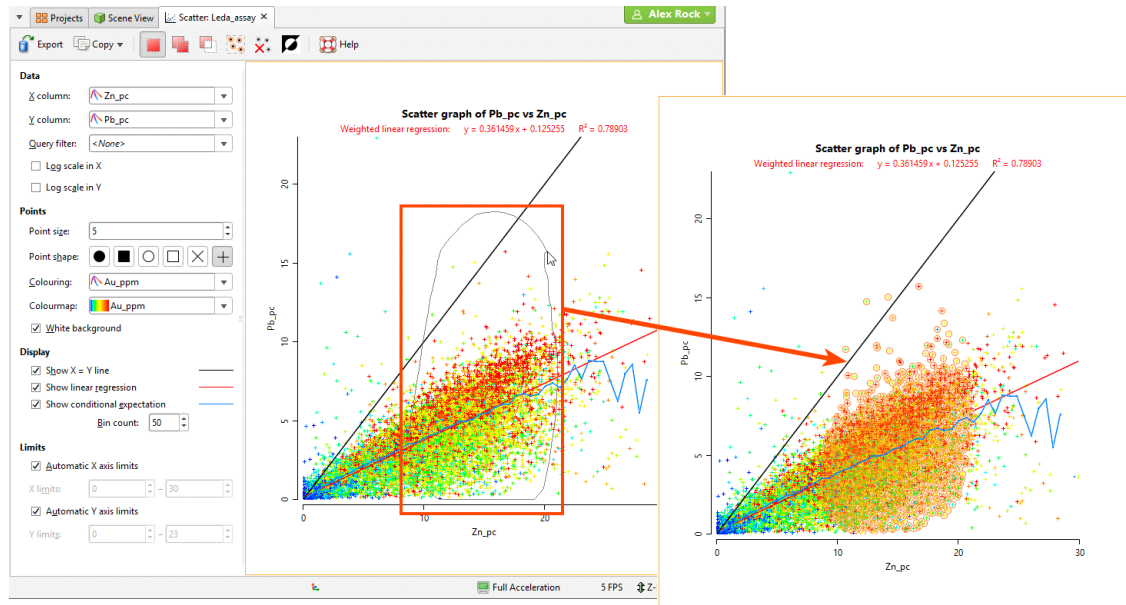

Selected points can be filtered in the scene by selecting the scatter plot from the **Query filter** options in the shape properties panel.

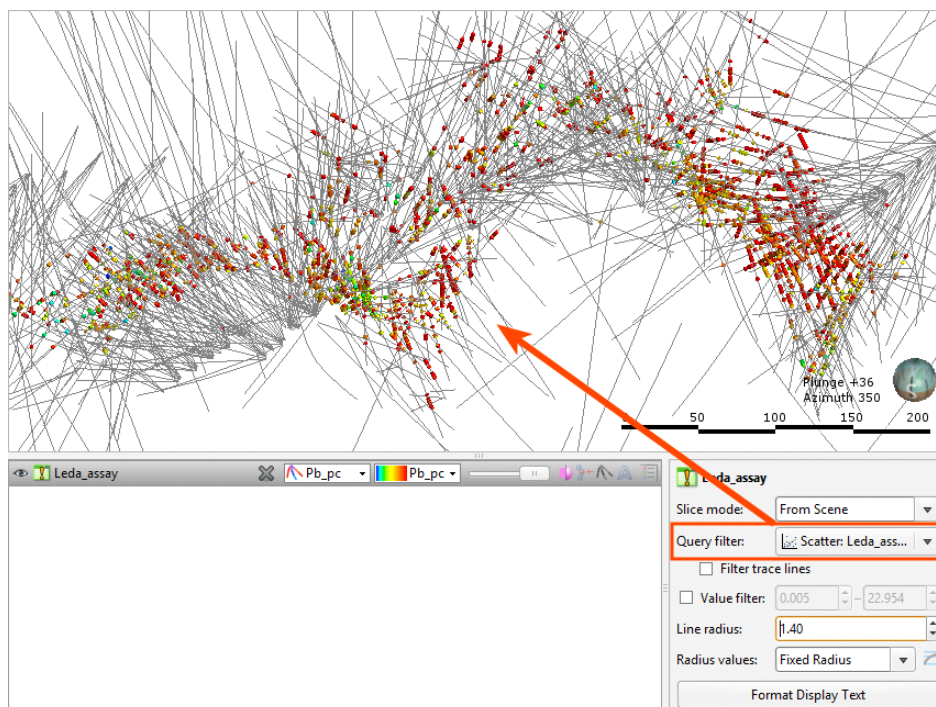

The **Add** button (📁) and the **Remove** button (🗑️) determine whether selected points are being added to or removed from the selection. For example, if you draw a polygon around a set of points with the **Add** button enabled, the points will be added to the selection.

You can also:

- Remove points from a selection while the **Add** button (📌) is enabled by holding down the Ctrl key and selecting points.
- Select all visible points by clicking on the **Select All** button (👤) or by pressing Ctrl+A.
- Clear all selected points by clicking on the **Clear Selection** button (✖) or by pressing Ctrl+Shift+A.
- Swap the selected points for the unselected points by clicking on the **Invert Selection** button (🔄) or by pressing Ctrl+I.

Q-Q Plots

Quantile-Quantile plots are useful for validating your assumptions about the nature of distributions of data. Select the data columns to show on the **X Axis** and **Y Axis** (which can optionally be set as log scales). You can also select an **X filter** and/or **Y filter** to limit the values used from the data columns.

Enable **Show X = Y line** to plot the mirror line for the chart, which may not always be obvious when the X and Y axis have different scales.

Show quartile line draws a line through two points on the chart, the lower quartiles and the upper quartiles for each of the axes.

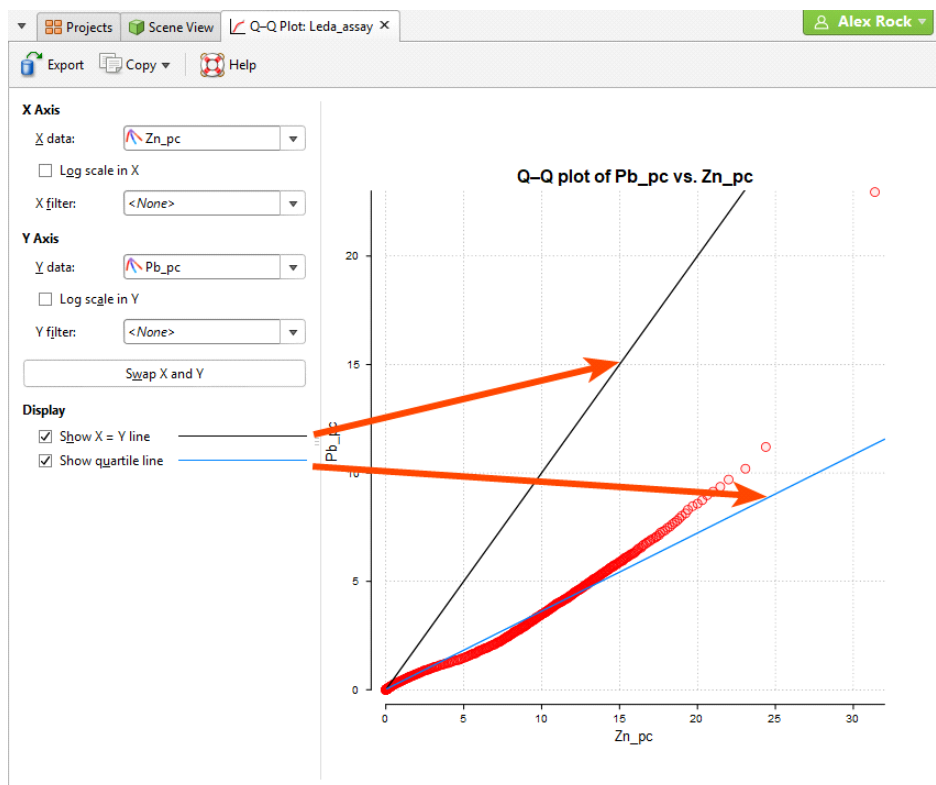

Box Plots

The box plot (or box-and-whisker plot) provides a visualisation of the key statistics for a data set in one diagram.

Select a **Numeric column** to display, enabling **Log scale** if it helps to visualise the data more clearly. If the table includes category data, set the **Category column** to one of the category columns to help visualise the data. Select which categories to include from the **Categories** list.

You can also use a pre-defined **Query filter** to limit the data included in the chart.

Note these features of the plot:

- The mean is indicated by the red diamond.
- The median is indicated by the line that crosses the inside of the box.
- The box encloses the interquartile range around the median.
- The whiskers extend out to lines that mark the extents you select, which can be the **Minimum/Maximum**, the **Outer fence** or the **Inner fence**. Outer and inner values are defined as being three times the interquartile range and 1.5 times the interquartile range respectively.

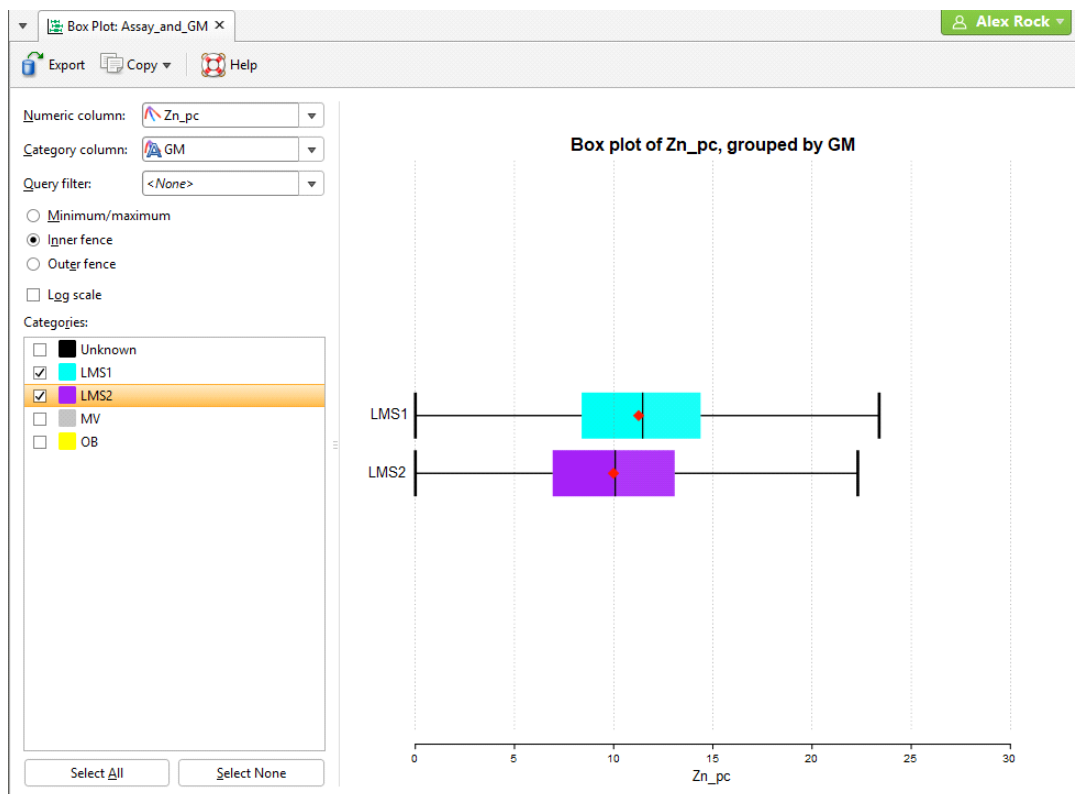

Note that a reminder of the reference for the **Outer fence** and **Inner fence** can be found by holding your mouse cursor over these fields to see the tooltip.

Univariate Graphs

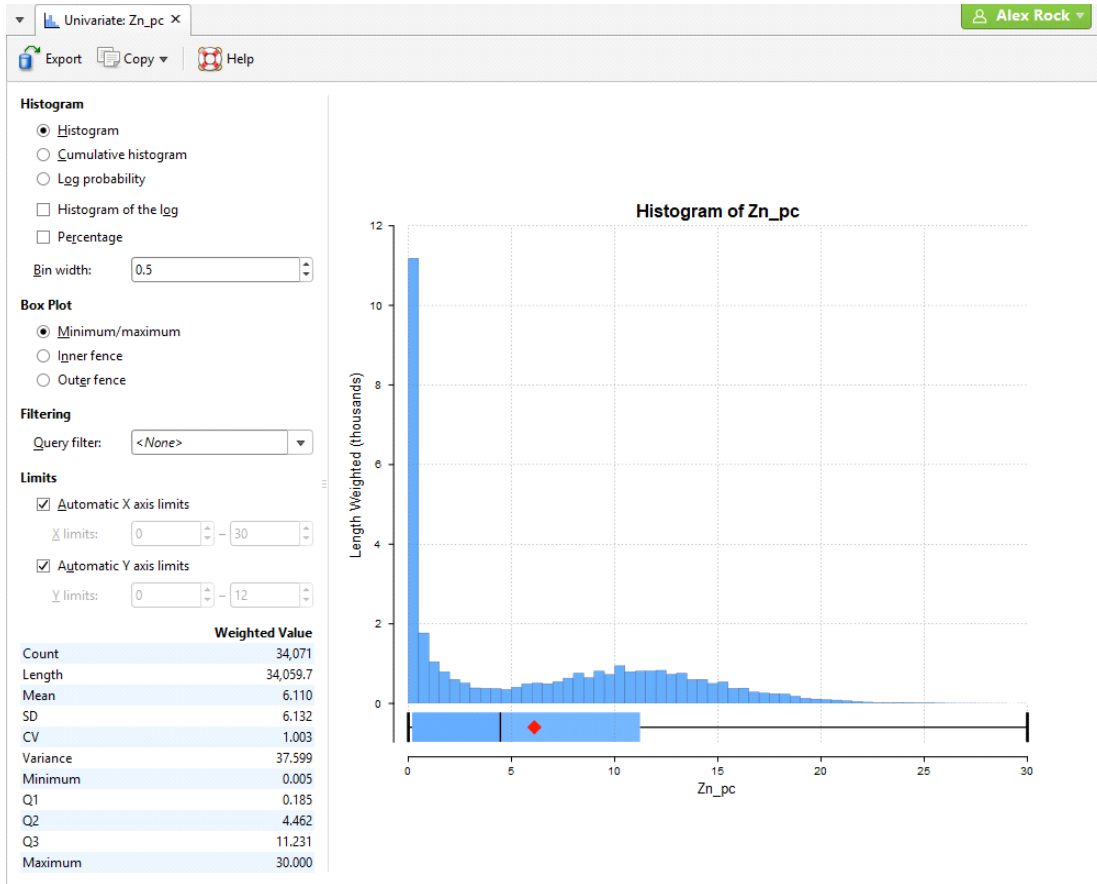

There are several different visualisation options. **Histogram** shows a probability density function for the values, and **Cumulative Histogram** shows a cumulative distribution function for the values as a line graph:

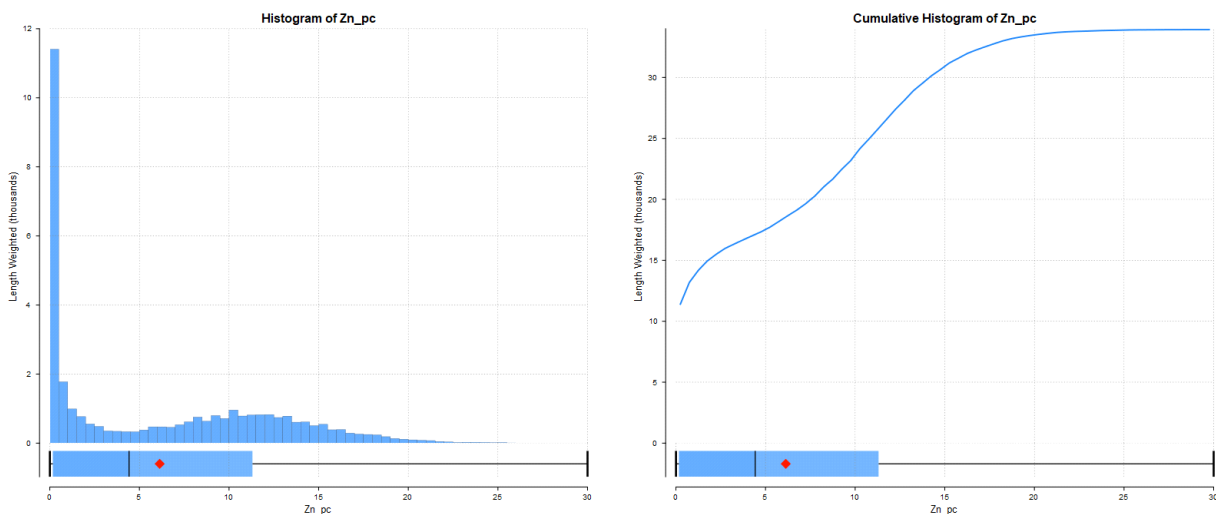

There are three options that show the charts with a log scale in the X-axis:

- Select **Histogram** and enable **Histogram of the log** to see the value distribution with a log scale X-axis.

- Select **Cumulative Histogram** and enable **Histogram of the log** to see a cumulative distribution function for the values with a log scale X-axis.
- **Log Probability** is a log-log weighted cumulative probability distribution line chart.

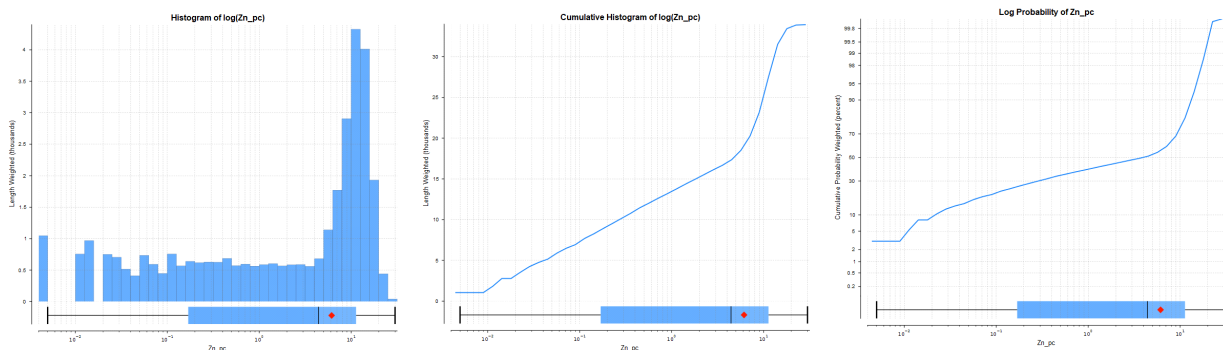

Percentage is used to change the Y-axis scale from a length-weighted scale to a percentage scale.

Bin width changes the size of the histogram bins used in the plot.

The **Box Plot** options control the appearance of the box plot drawn under the primary chart.

The whiskers extend out to lines that mark the extents you select, which can be the **Minimum/maximum**, the **Inner fence** or the **Outer fence**. Inner and outer values are defined as being 1.5 times the interquartile range and 3 times the interquartile range respectively.

Some univariate graphs may include a **Filtering** option containing where a **Query filter** defined for the data set can be selected.

The **Limits** fields control the ranges for the X-axis and Y-axis. Select **Automatic X axis limits** and/or **Automatic Y axis limits** to get the full range required for the chart display. Untick these and manually adjust the **X limits** and/or **Y limits** to constrain the chart to a particular region of interest. This can effectively be used to zoom the chart.

The bottom left corner of the chart displays a table with a comprehensive set of statistical measures for the data set.

Well Correlation Tool

With the well correlation tool, you can view and compare selected wells in a 2D view. You can then create interpretation tables in which you can assign and adjust intervals and create new intervals. Interpretation tables are like any other interval table in a project and can be used to create models. You can also save and export correlation set layouts and styles that can be exported and used in other Leapfrog Geothermal projects.

This topic describes creating correlation sets and creating interpretation tables. It is divided into:

- [Selecting Collars](#)
- [The Correlation Set Window](#)
- [Correlation Column Layouts](#)
- [Managing Styles](#)
- [Interpretation Tables](#)

Selecting Collars

To select collars, you need to create a well correlation set, which you can do from the scene. First, add the collars you wish to work with to the scene. A useful way of limiting the number of collars displayed is to draw a slice in the scene and set it to a thick slice (🔪) and set the slice width to hide collars on either side of the slice.

Next, right-click on the **Well Correlation** folder and select **New Well Set**. The new set will be created and opened, but is empty until you select collars. Click the **Select Collars** button (🔗) to switch to the scene and begin selecting collars:

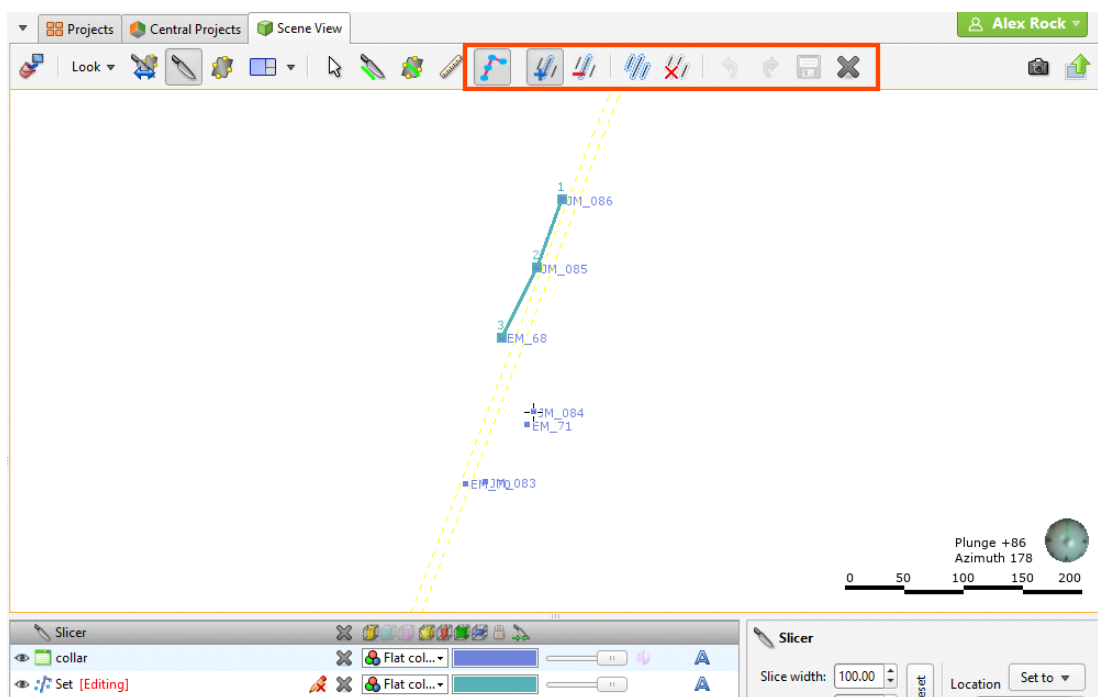

The line in the scene indicates the order in which collars will appear in the set.

- To select collars one-by-one, click on the **Select collar** button (🔍), then on the **Add collar** button (➕). Click on a collar to add it to the nearest end of the set. Hold down the Ctrl key while clicking to remove a collar from the set.
- To temporarily switch to the **Select** button (👉), hold down the Shift key while clicking.
- To select all collars visible in the scene, click on the **Select all collars** button (👉). This will select collars using the best fit line.
- To remove a collar from the selection, click on the **Remove collar** button (➖), then click on the collar you wish to remove from the set.
- To clear the selection, click on the **Clear collar selection** button (🗑️).

If you want to change the order, you can easily do so in the set tab once you have selected collars.

Once you have selected the required collars, click the **Save** button (💾). The selected collars will be added to the set window:

EM_70	JM_083	EM_71	JM_084	EM_68	JM_085	JM_086	EM_72	EM_73
Depth	Depth	Depth	Depth	Depth	Depth	Depth	Depth	Depth
0.0	0.0	0.0	0.0	0.0	0.0	0.0	0.0	0.0
10.0	10.0	10.0	10.0	10.0	10.0	10.0	10.0	10.0
20.0	20.0	20.0	20.0	20.0	20.0	20.0	20.0	20.0
30.0	30.0	30.0	30.0	30.0	30.0	30.0	30.0	30.0
40.0	40.0	40.0	40.0	40.0	40.0	40.0	40.0	40.0
50.0	50.0	50.0	50.0	50.0	50.0	50.0	50.0	50.0
60.0	60.0	60.0	60.0	60.0	60.0	60.0	60.0	60.0
70.0	70.0	70.0	70.0	70.0	70.0	70.0	70.0	70.0
	80.0	80.0	80.0	80.0	80.0	80.0		
	90.0	90.0	90.0	90.0	90.0	90.0		
			100.0		100.0	100.0		
					110.0	110.0		

The Correlation Set Window

Remove collars from the correlation set by either editing the set in the scene, as described in [Selecting Collars](#) above, or right-click on a column and select **Remove collar**:

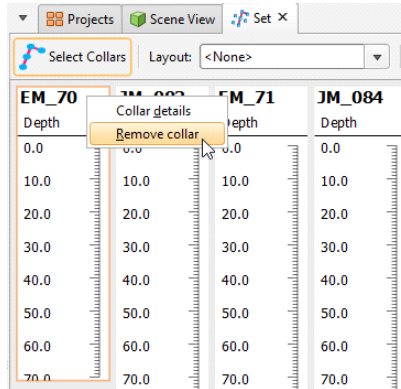

You can change how data is displayed by clicking on the column header, then selecting **Format**:

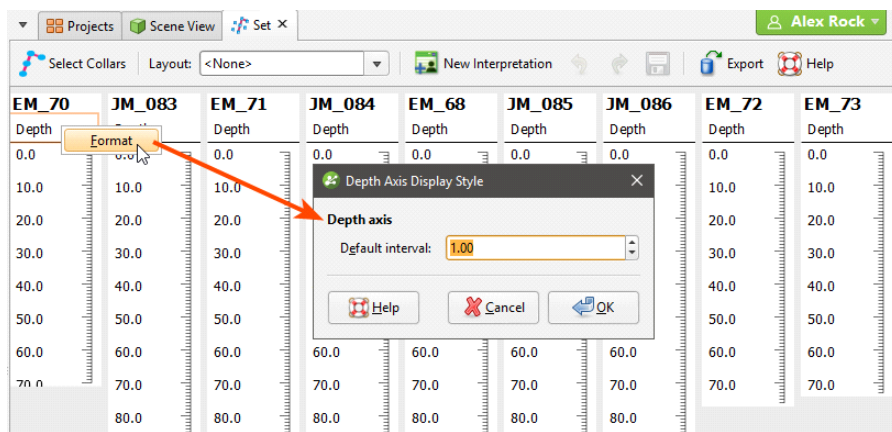

The options available depend on the type of column being formatted.

Click on wells and drag them in the correlation set window to change the order in which they appear:

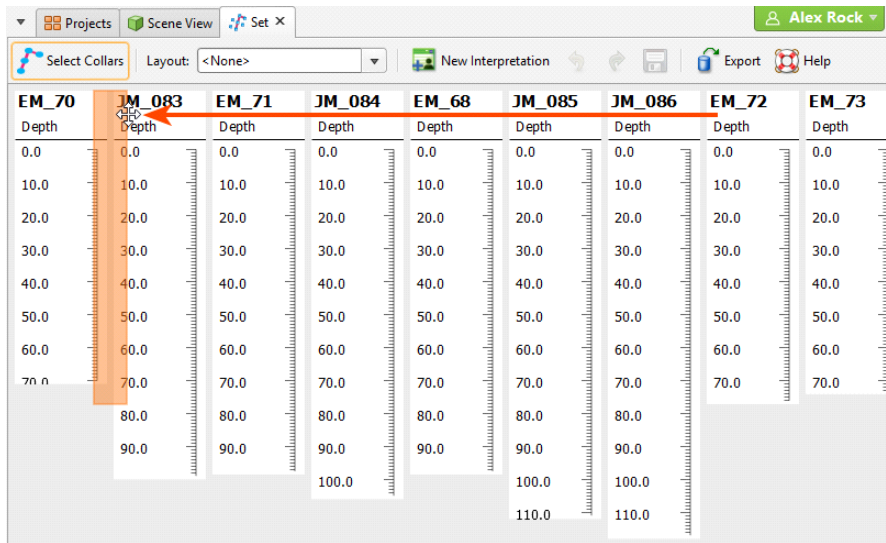

Add columns to the set by dragging them from the project tree into the set window. Here, four columns have been added to the set. From right to left they are a lithology column, an assay data column, a points data column formatted as a line and a points data column formatted as points:

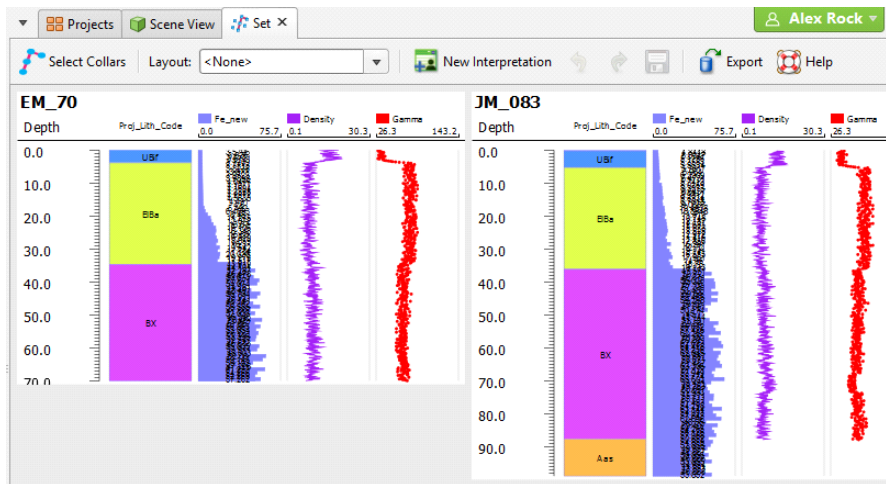

You can then format the columns to get a better view of relationships between them. Format columns by right-clicking on their headers and selecting **Format**:

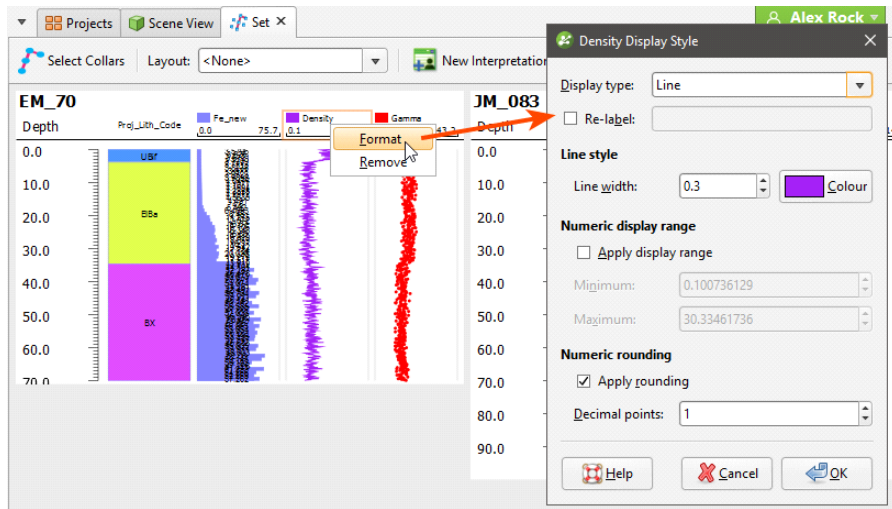

The styles used to display columns can be used by other sets in the project and can be exported to other projects. See [Managing Styles](#) below.

You can also drag some types of columns on top of other columns, although it is not possible to display category data on top of other category data. You can select multiple columns using the Shift and Ctrl keys.

Navigating in the Correlation Set Window

Navigate in the correlation set window using the following mouse and keyboard combinations:

- Use the scroll wheel to move up and down.
- Hold down the Shift key while scrolling to move right and left.
- Hold down the Ctrl key while scrolling to zoom in and out.
- Hold down the Alt key while scrolling to stretch the data vertically.

Correlation Column Layouts

Once you have organised data columns and how they are displayed, you can save this information as a column layout that can be applied to other correlation sets. To do this, click the **Layout** button in the toolbar and select **Save Current Layout** from the list:

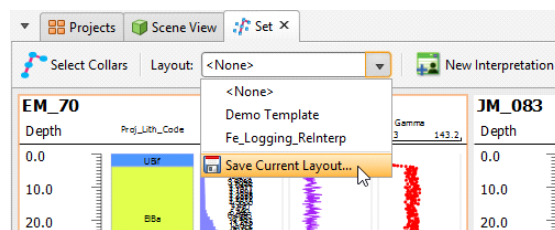

You will be prompted for a name. Click **OK** to save the layout, which can then be applied to other correlation sets by selecting the layout from the list.

To view the layouts available in the project, right-click on the **Well Correlation** folder in the project tree and select **Layout Manager**. In the window that appears, you can easily see what columns are used for each layout and apply a layout to all correlation sets in a project:

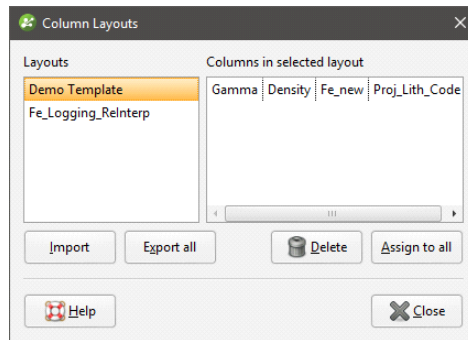

You can also export column layouts for use in other projects and import layouts from other projects. Clicking **Export all** exports layouts as a text file.

Managing Styles

The styles used to display data columns can also be exported to other projects. To view the styles used in the project, right-click on the **Well Correlation** folder in the project tree and select **Style Manager**:

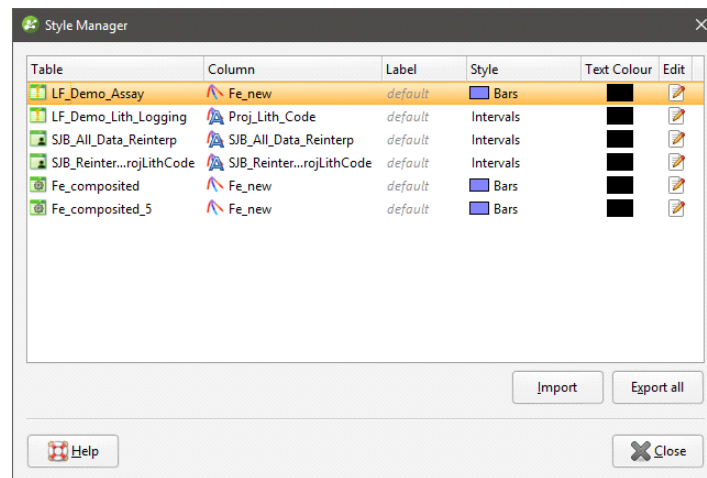

Click **Edit** to change a style, which will update objects that use the selected style throughout the project.

Click **Export all** to export the styles in the project as a text file that can be imported into other projects.

Interpretation Tables

With interpretation tables, you can assign and adjust intervals and create new intervals. Interpretation tables are like any other interval table in a project and can be used to create models.

To create an interpretation table, click the **New Interpretation** button in the correlation set window. The **New Interpretation Table** window will be displayed:

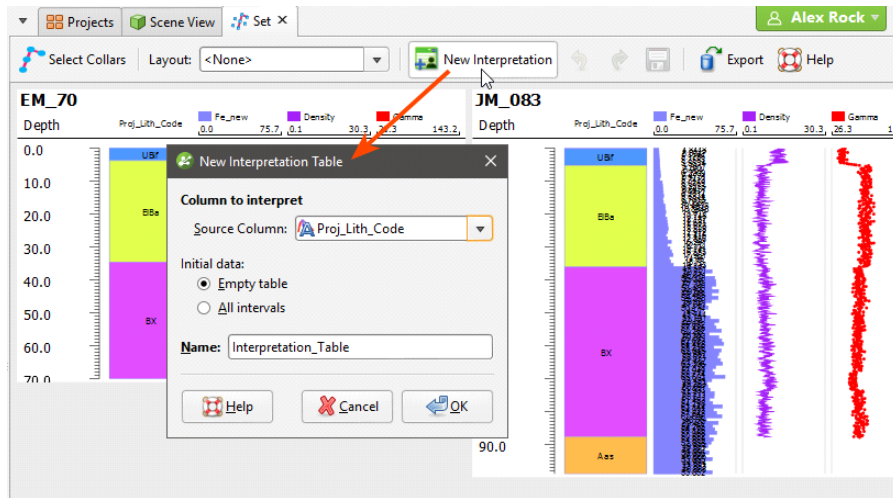

There are three options for creating an interpretation table:

- Create the table without using a base table. Each well will have an empty legend and a single empty interval from 0 to its maximum depth. Select **<None>** for the **Source Column**.
- Create the table from a base column but have no intervals. This copies the base column’s legend but no intervals. Select the **Source Column**, then select **Empty Table**.
- Create a copy of a table. Select the **Source Column**, then select **All Intervals**.

Click **OK** to create the table. A new interpretation table will be added to the project tree under the **Wells** object and the column will be added to the correlation set window:

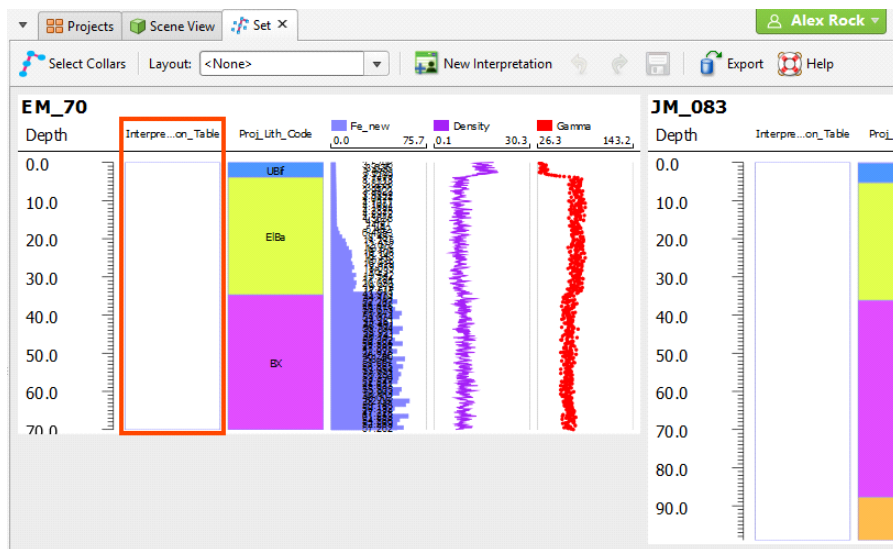

Assigning Lithologies

If you have created the interpretation table without using a base table, you will need to assign lithologies to the new table. Do this as part of working with the table in the correlation set window, which is described below.

Modifying the Interpretation Table

In the correlation set window, the blue line is used to create intervals. Position the blue line then right-click on it and select one of the options:

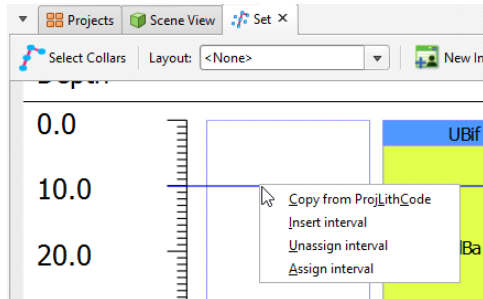

- The **Copy from** option assigns intervals from the base table.
- The **Insert interval** option adds an empty interval that overrides any intervals already defined.
- The **Unassign interval** option clears the lithology assigned to the interval.
- The **Assign interval** option opens the legend for the interpretation table so you can select a lithology to assign to the interval. If you need to add lithologies, you can do so in this window.

For example, to create an interval at the top of the table called "High Density", move the blue line near to where you wish to create the interval. You do not need to be precise as you can adjust the interval once you have added it. Right-click and select **Insert interval**:

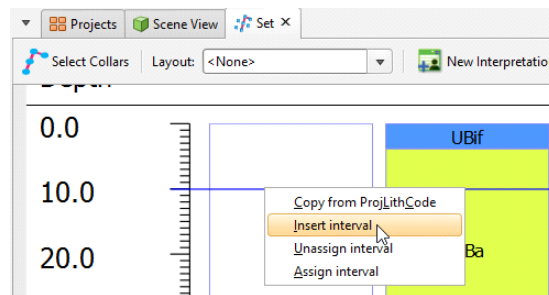

In the legend window, click the **Add** button and add a lithology called “High Density”:

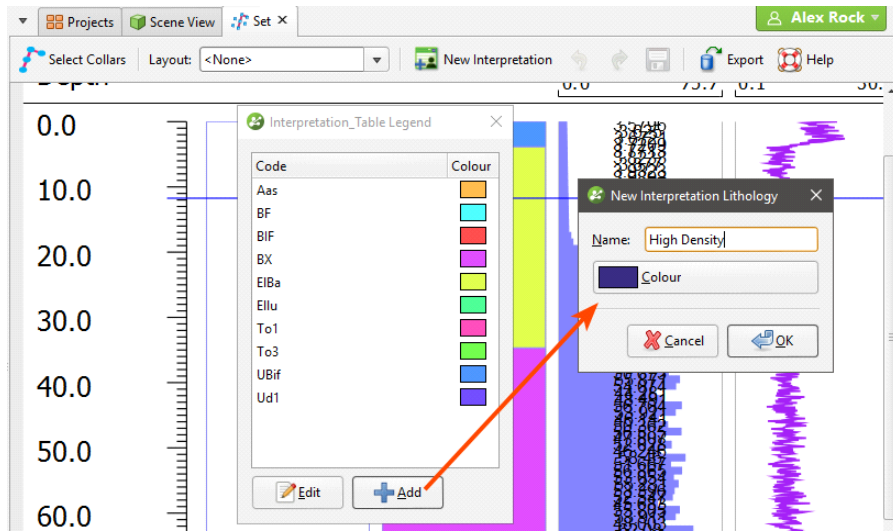

Click **OK**, then select the new lithology to close the legend window. The new lithology has been assigned to the interval:

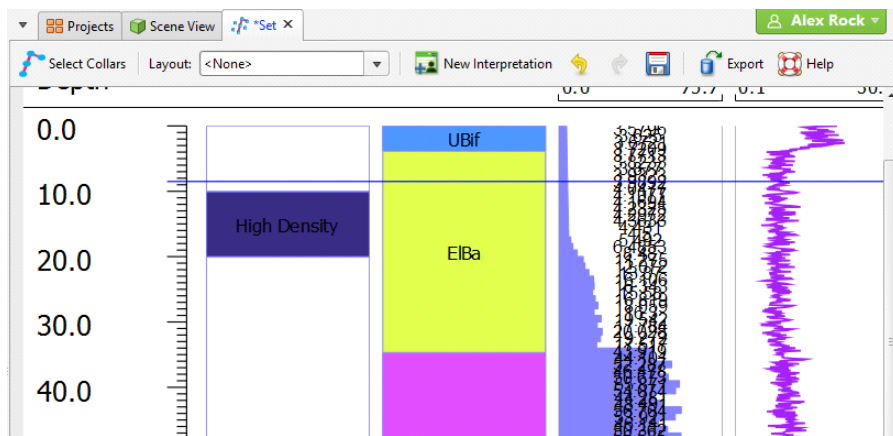

To resize the interval, click and drag the interval end points:

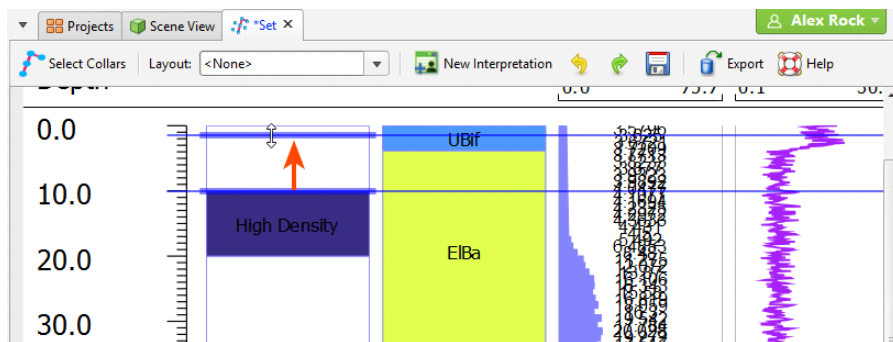

You can move the interval end point and snap it to a data point in another column. To do this:

1. Click on the interval end point and drag it into position without releasing the mouse button.
2. Move the mouse across to the data point you wish to snap to.
3. Release the mouse.

You can also snap to points along the depth axis.

Continue making changes to the interpretation table, using the **Undo** button to step backwards if necessary. Save changes to update the table.

Stereonet

Stereonets are useful for visualising structural data and identifying trends in 2D. Errors in categorisation of structural data can also become apparent when the data is viewed on a stereonet.

There are two types of stereonet available in Leapfrog Geothermal: equatorial stereonet and polar stereonet. The process of creating a stereonet is the same for both types; you can change the type of stereonet by clicking the **Options** button in the stereonet window. Both Fisher and Bingham statistics are available for stereonets.

This topic describes how to work with stereonets in Leapfrog Geothermal. It covers:

- [Creating a Stereonet](#)
- [Displaying the Stereonet in the 3D Scene](#)
- [Plot Options](#)
- [Data Display Options](#)
- [Viewing Stereonet Statistics](#)
- [Selecting Data in the Stereonet](#)
- [Using the Scene Window with the Stereonet](#)
- [Exporting a Stereonet](#)

Creating a Stereonet

Create a stereonet by right-clicking on the **Stereonets** folder (in the **Structural Modelling** folder) and selecting **New Stereonet**. The stereonet is created and opened in a new tab. Click the **Add** button to add any structural data table in the project to the stereonet:

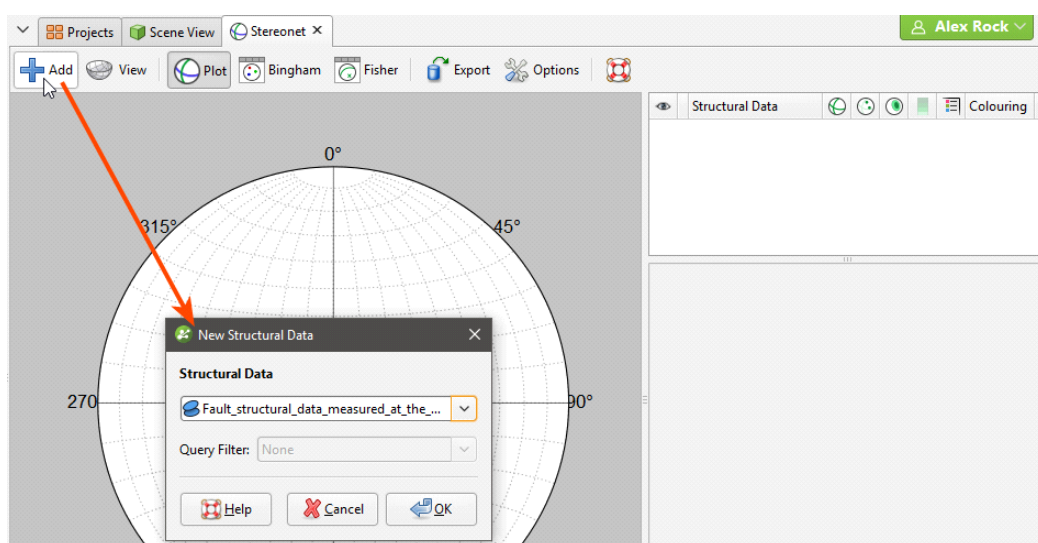

You can also drag and drop structural data objects from the project tree into the stereonet.

See [Plot Options](#) and [Data Display Options](#) below for information on the different options available for stereonet.

Displaying the Stereonet in the 3D Scene

You can display the stereonet in the 3D scene by dragging the stereonet from the project tree into the scene or by clicking on the **View** button (🌐) in the stereonet window:

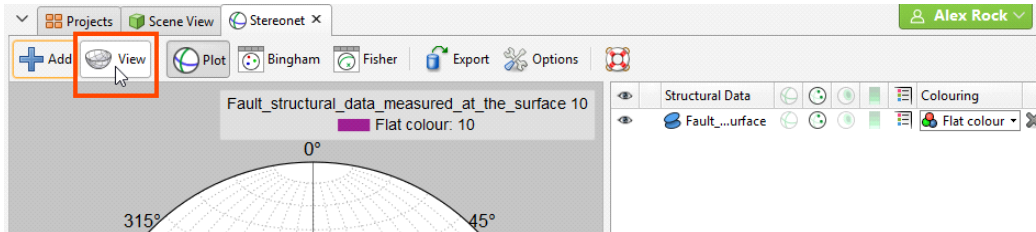

You can display planes and poles in the 3D scene, but not contours. In the shape list, you can control whether planes or poles are displayed in the scene:

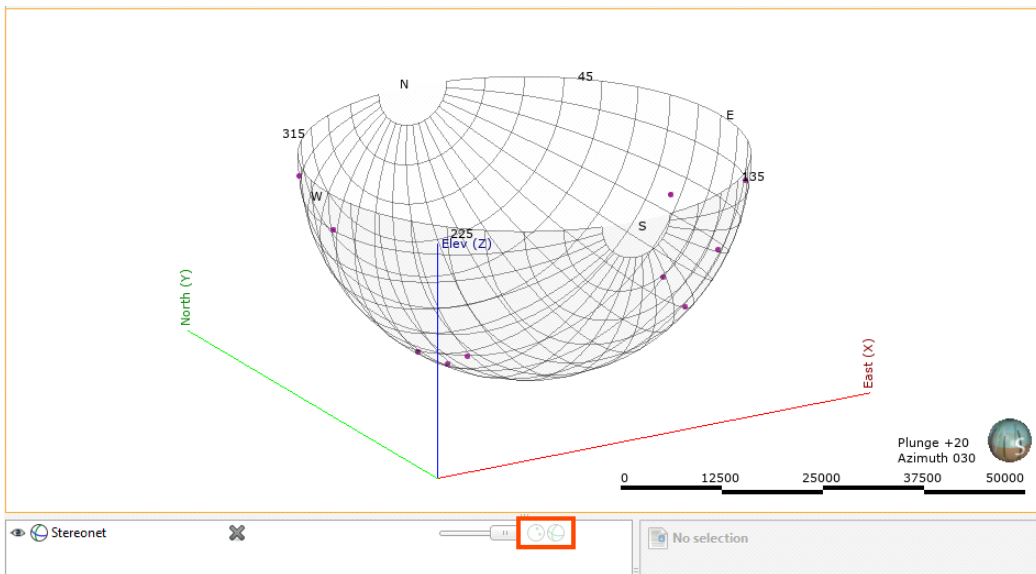

Otherwise, the appearance of the stereonet in the 3D scene is controlled from the stereonet window.

In the scene, you can:

- Resize the stereonet in the scene. Click on it and use the green arrows to resize it.
- Move the stereonet around in the scene. The controls are the same as those for the moving plane.
- Centre the stereonet on its input data. To do this, click on the stereonet in the shape list and then select from its inputs in the **Move to** list.

Plot Options

Click **Options** to change plot options:

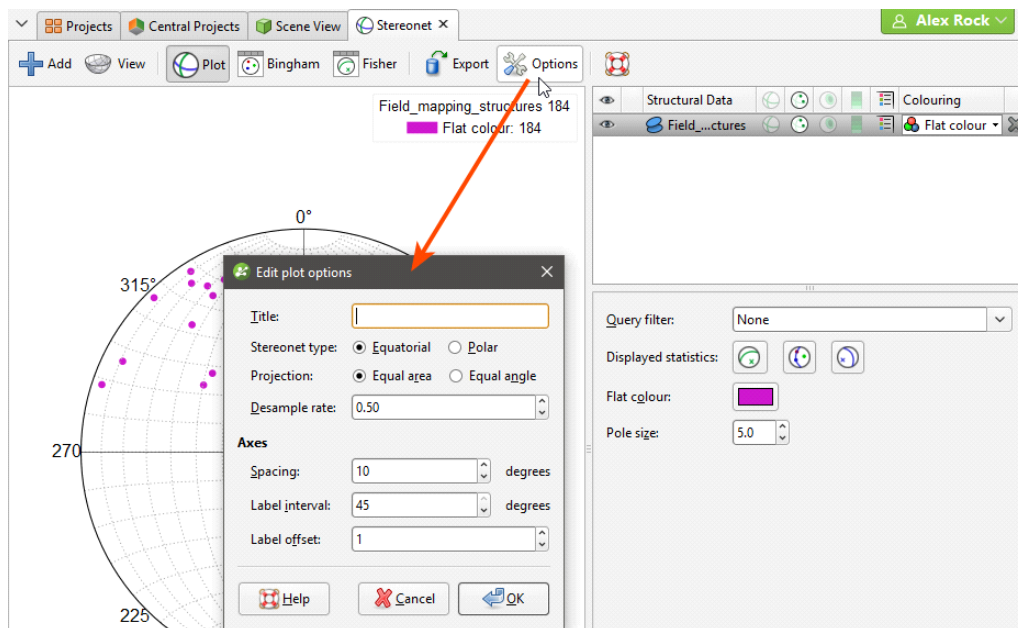

There are two types of stereonet available, **Equatorial** and **Polar**. You can also choose between **Equal area** (Schmidt) and **Equal angle** (Wulff) projections.

The **Desample rate** affects how quickly data is displayed by combining points with duplicate orientations, as determined by the **Desample rate** value. A low value will filter fewer data points, whereas a higher value will filter out more data. Setting the **Desample rate** to 0 plots all points, which may be slow for very large data sets that have not been declustered. The **Desample rate** applies only to how data is displayed; it does not affect the data in the table.

Note that the settings in **Edit plot options** window only apply to the current stereonet. If you want to create a stereonet "template" for your project, you can create a new stereonet with different plot options and make copies of it in the project tree:

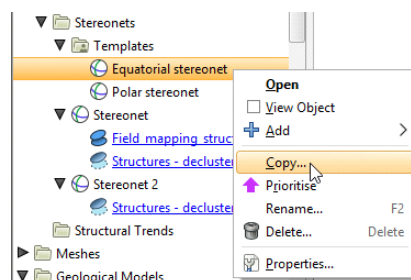

Data Display Options

Planar structural data can be displayed as planes (☺), poles (☹) or contours (☺), using the colouring from any column in the structural data table. Lineations can be displayed as poles (☹) or contours (☺). Contour methods available are **Schmidt**, **Exponential Kamb** and **Kamb**, and contours can be displayed filled or outlined.

Click on a line or pole to view information about the data point:

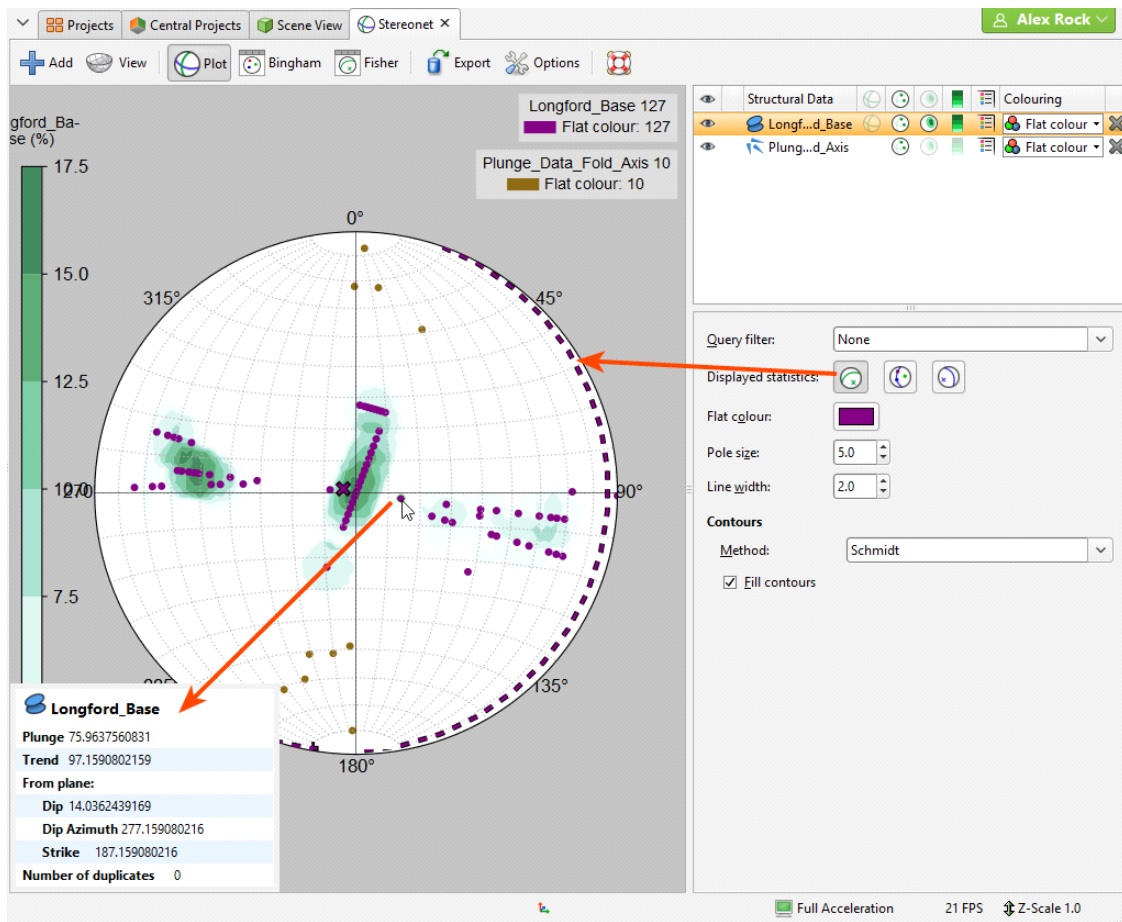

The information displayed includes whether or not there are duplicates of the selected data point in the data set.

Click the mean button (🕒) to view the Fisher mean on the stereonet, which is displayed as a line for planar structural data and as an X for lineations. You can also display the Bingham best-fit plane (🕒) and eigenvectors e1, e2 and e3:

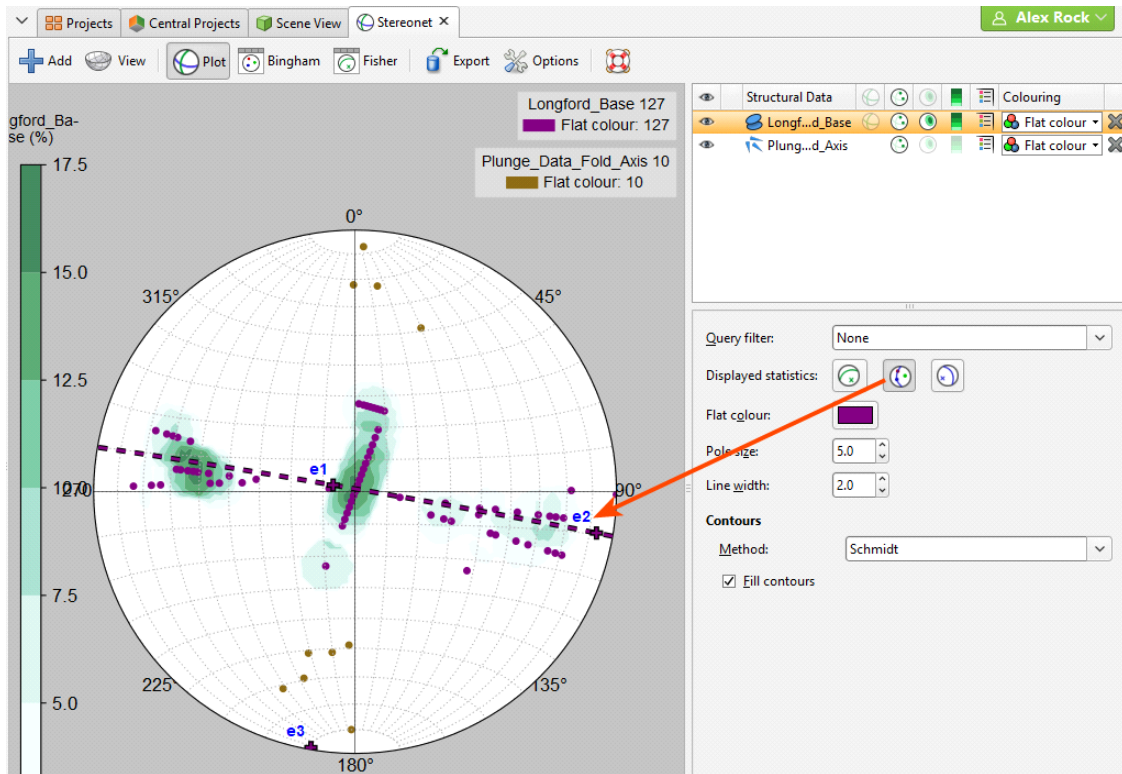

For planar structural data, you can also display the Bingham mean plane (🕒):

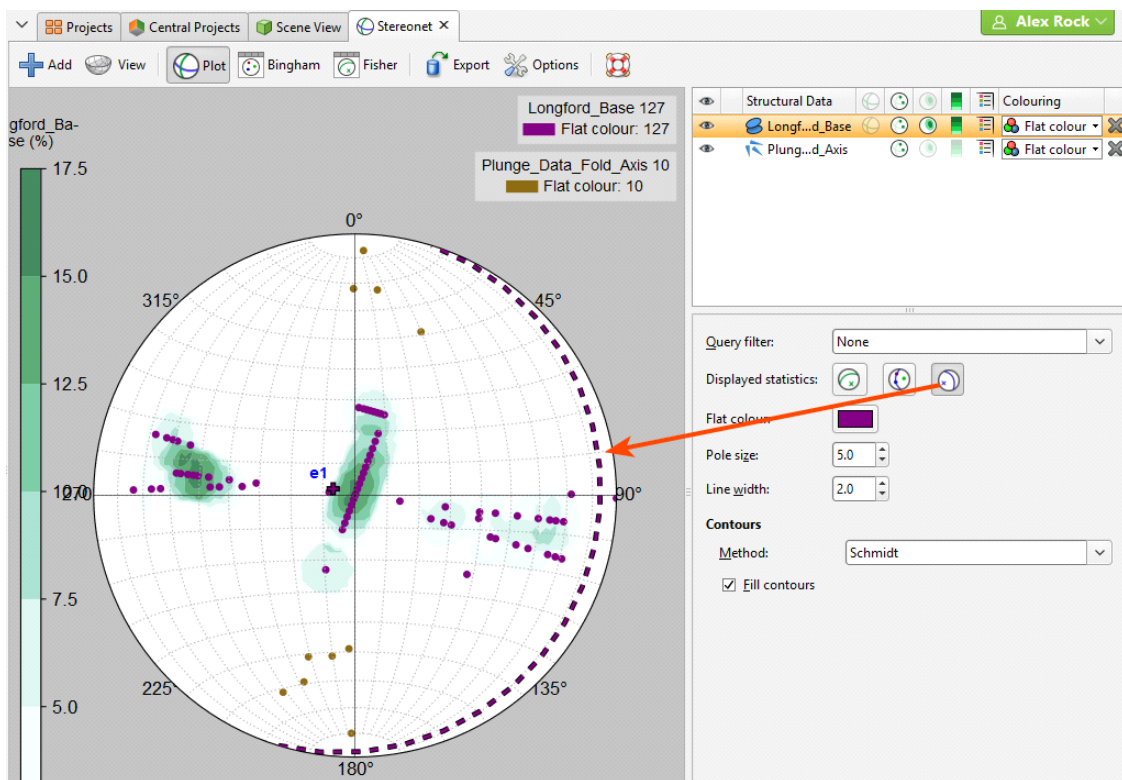

A legend can be displayed for the stereonet as a whole (📄) and for the contours (📄). The stereonet's legend is generated from the categories that are visible in the list of colourings. Here, the categories displayed are from the Bedding column:

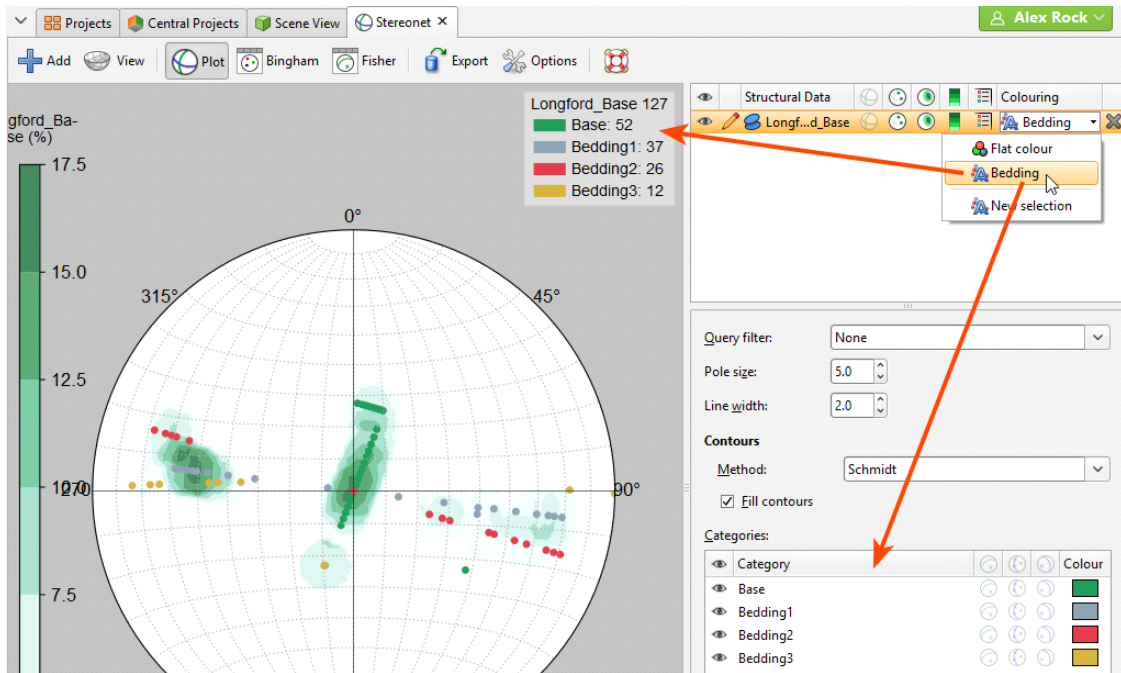

You can apply query filters from those available in the project.

Declustered data can be viewed on stereonets in two ways:

- Declustered data can be viewed directly on the stereonet. Simply drag the declustered table into the stereonet.
- If the declustered data's parent data table is displayed on the stereonet, the declustered data is available as a filter.

For example, here a structural data table is displayed on a stereonet along with a declustered table. The declustered table is available as a query filter for its parent object:

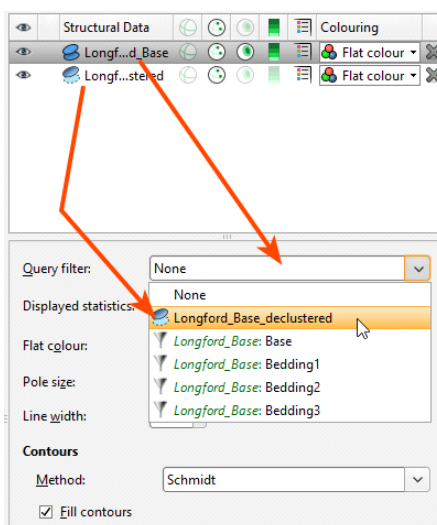

Viewing Stereonet Statistics

To view statistics on the data displayed on the stereonet, click either the **Bingham** button or the **Fisher** button:

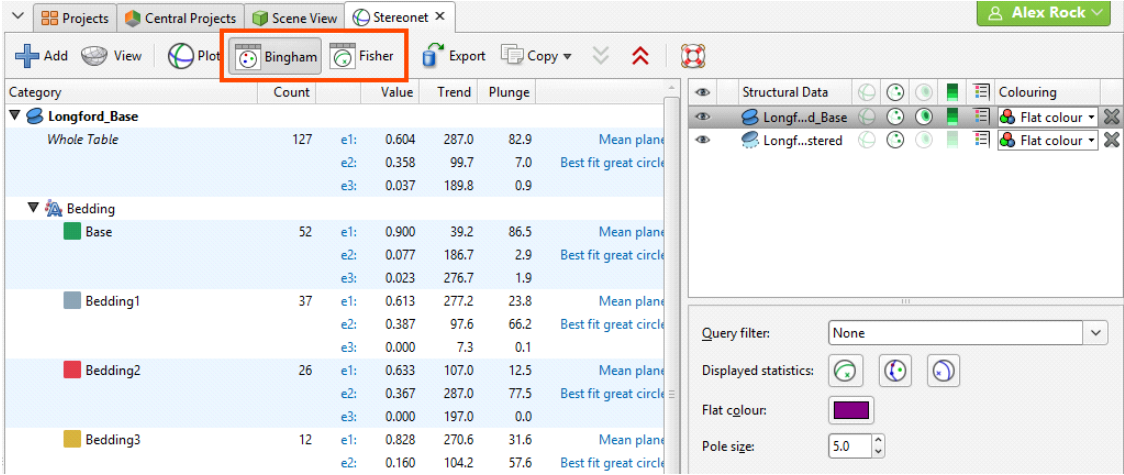

You can select specific rows and copy them to the clipboard or copy all data to the clipboard.

Selecting Data in the Stereonet

You can select data in the stereonet and assign it to new categories or existing ones. To do this, click on the data table in the stereonet window and select **New selection** from the colouring list:

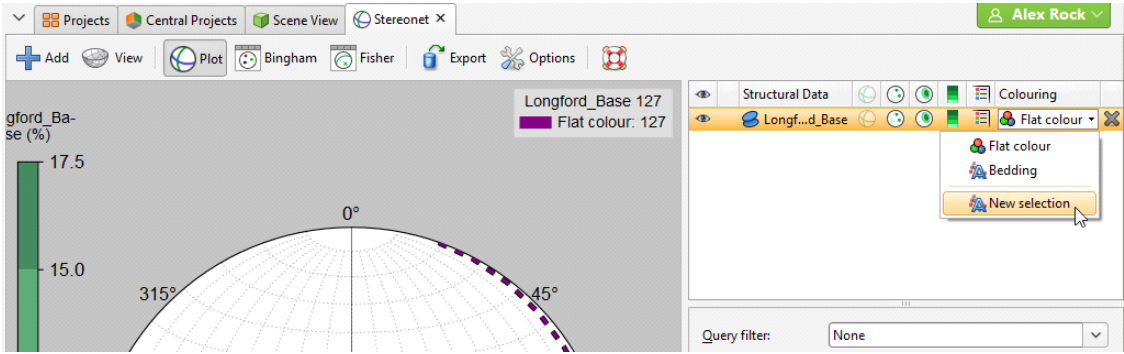

The **New Category Selection** window will appear:

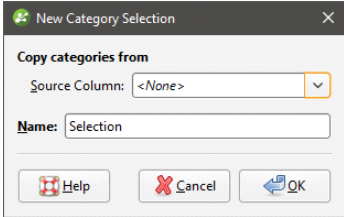

The poles will be displayed in the stereonet, if they are not already visible, and the data table will also be added to the scene window, together with tools for selecting points in the scene.

Organising the stereonet tab and the **Scene View** tab so they are displayed side-by-side can be useful in working with the data as you can select data in the stereonet or in the scene window. This is described further in [Using the Scene Window with the Stereonet](#) below.

If you select an existing column as the **Source Column**, you can assign selected points to the existing categories or create new categories. If you select **<None>** for the **Source Column**, you will have to define each category manually.

When you click **OK**, a set of tools for selecting data will be added to the stereonet window:

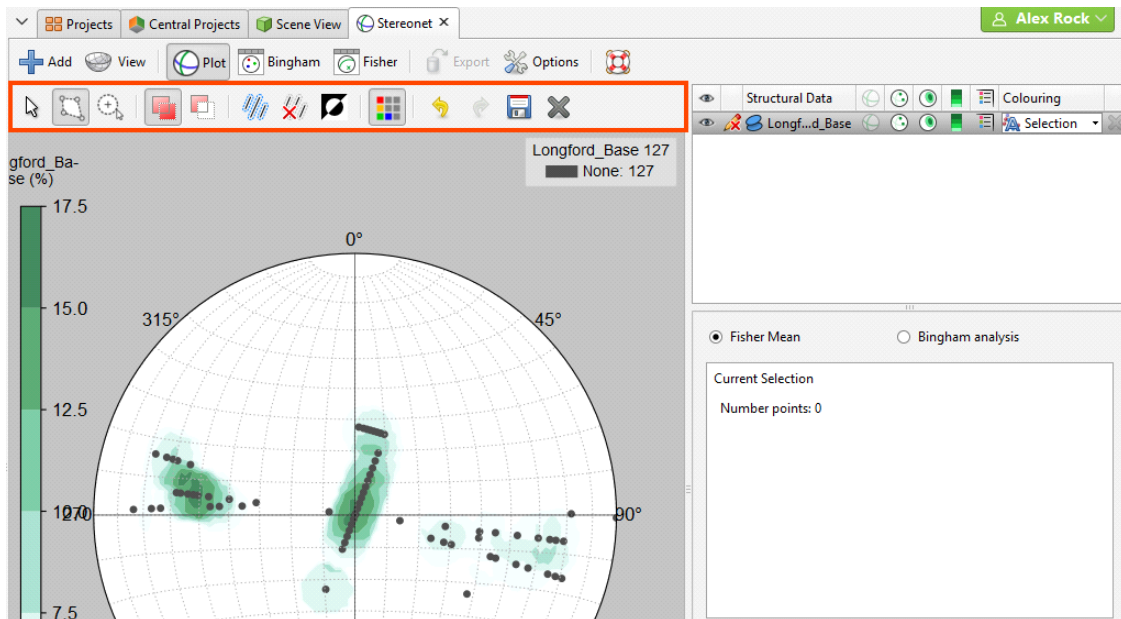

There are two tools for selecting data in the stereonet, the polygon tool (📐) and the bullseye (🎯) tool.

- Use the polygon tool (📐) to draw around the points you wish to select. Closing the polygon will select the points, and you can click on the vertices to refine the shape of the selection. Click outside of the selection to clear the polygon.
- Use the bullseye tool (🎯) to:
 - Click on points one-by-one.
 - Click and drag around points.

The **Add** button (📌) and the **Remove** button (🗑️) determine whether selected points are being added to or removed from the selection. For example, if you draw a polygon around a set of points with the **Add** button enabled, the points will be added to the selection.

You can also:

- Remove points from a selection while the **Add** button (📌) is enabled by holding down the Ctrl key and selecting points.
- Select all visible points by clicking on the **Select All** button (👤) or by pressing Ctrl+A.
- Clear all selected points by clicking on the **Clear Selection** button (🗑️) or by pressing Ctrl+Shift+A.

- Swap the selected points for the unselected points by clicking on the **Invert Selection** button (☒) or by pressing Ctrl+I.
- Show or hide all unassigned points using the **Unspecified Measurements** button (☐).

Statistics are shown for the currently selected set of points:

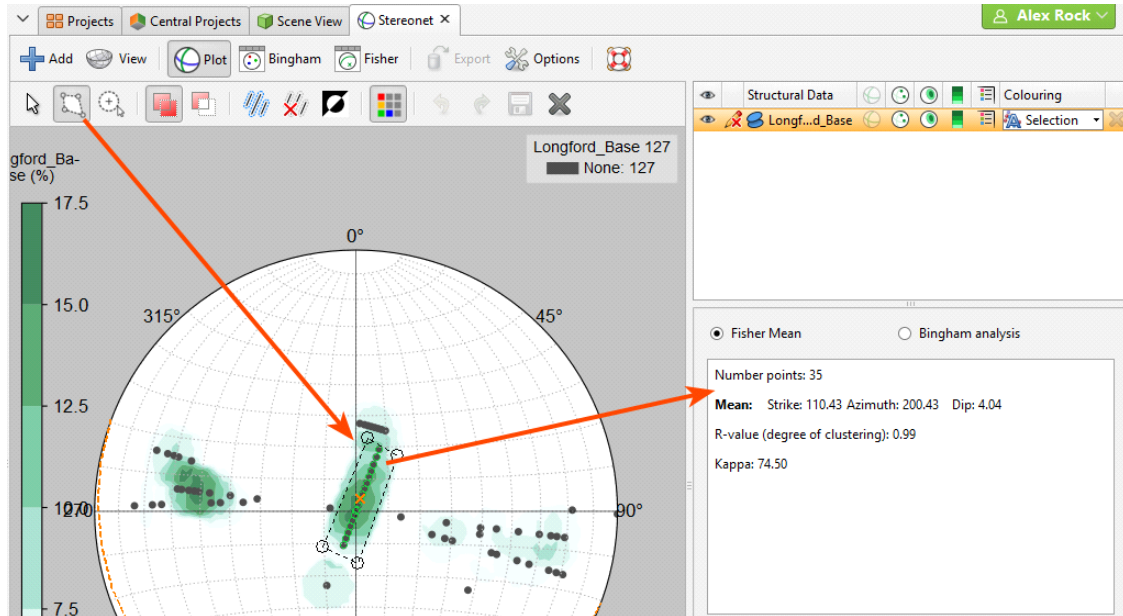

You can choose what type of statistics to display for selected points:

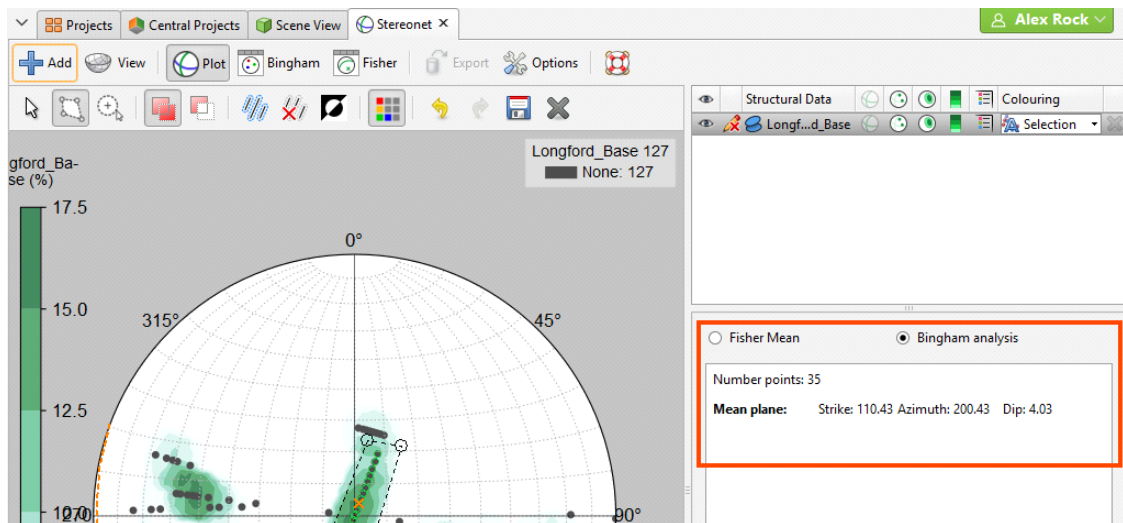

Once you have selected a set of points, click the **Assign to** button in the stereonet window, then select **Create New Category**. In the window that appears, enter a name for the category and assign a colour:

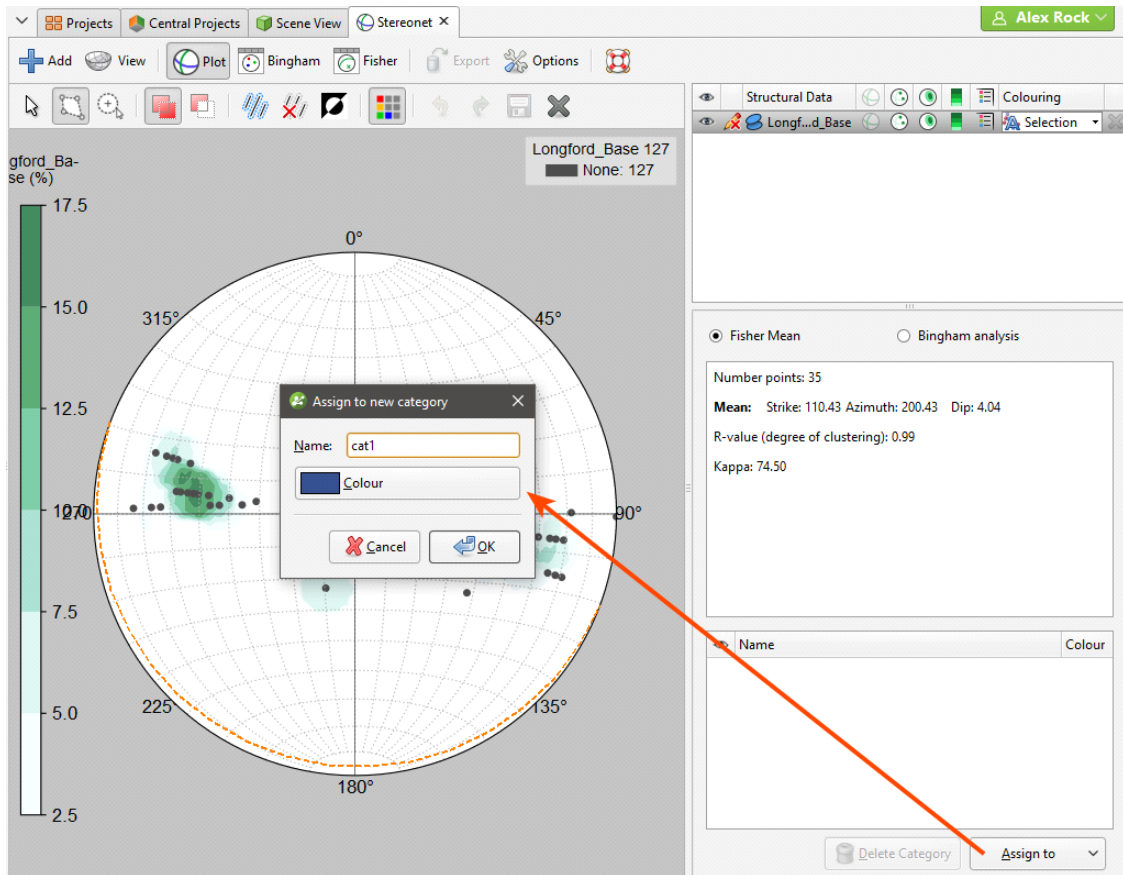

Click **OK**. The new category will be created and the stereonet will be updated to reflect the changes:

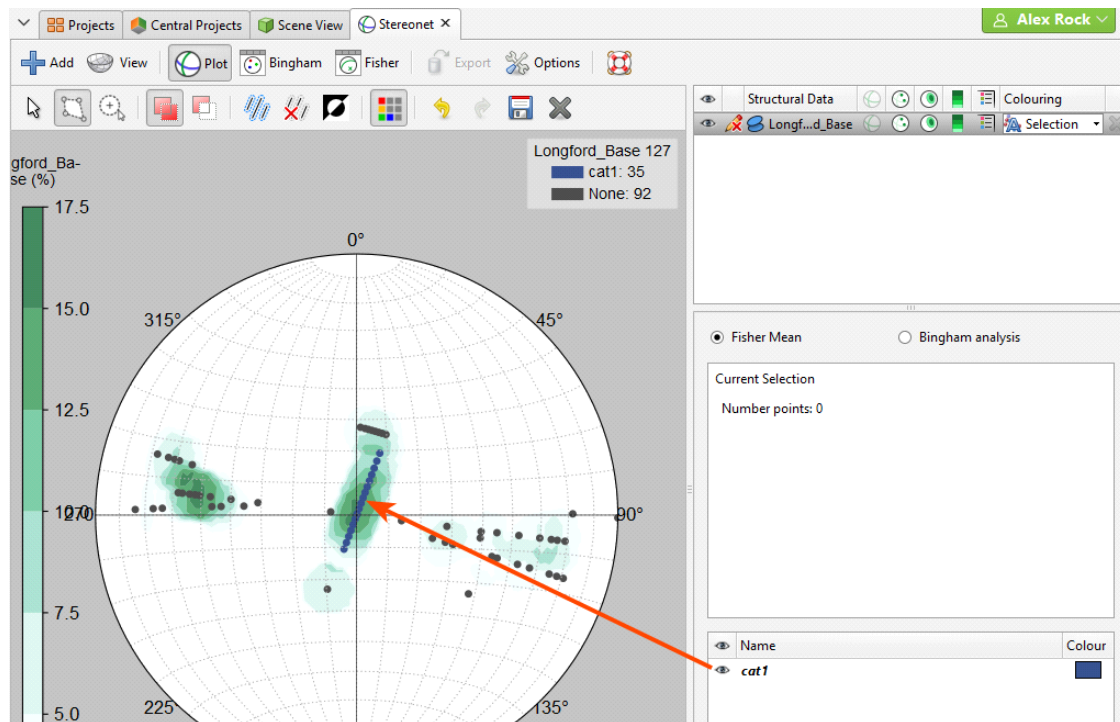

The scene window will also be updated.

Once you have created a new category, you can add to it by selecting further points, then selecting the category from the **Assign to** list.

When you are finished, click the **Save** button (📁) and close the category editor. You can make further edits by clicking the **Edit** button (✎) in the stereonet window.

Using the Scene Window with the Stereonet

You can also select points in the scene window by clicking on the **Select points** tool () , then drawing over those points in the scene:

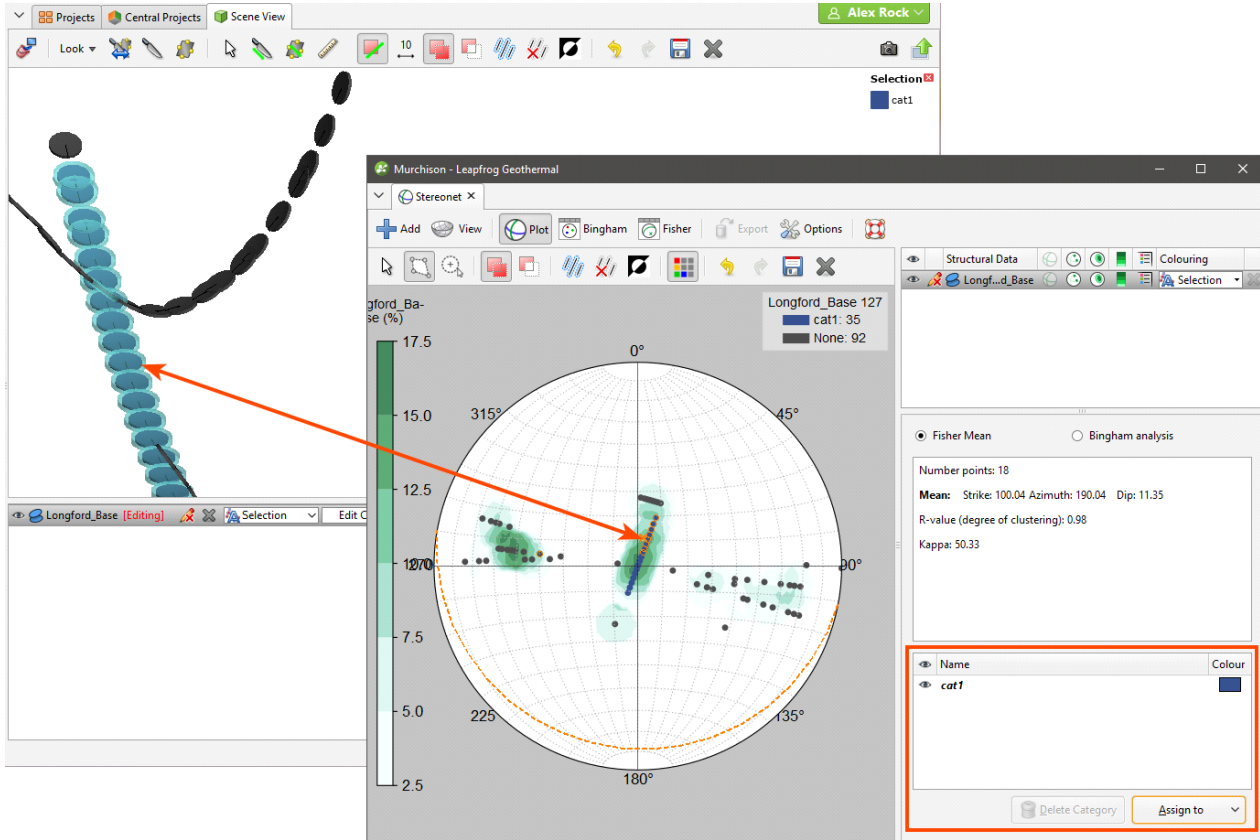

Controls for assigning points to categories will remain in the stereonet window, and both the stereonet window and the scene window will be updated to reflect the selected and assigned points.

Exporting a Stereonet

Stereonets can be exported in the following formats:

- PDF Files (*.pdf)
- Scalable Vector Graphics Files (*.svg)
- PNG Image Files (*.png)

Click the **Export** button. Select a format and navigate to the folder where you wish to save the file. Enter a name and click **Save**.

Form Interpolants

A form interpolant is an RBF interpolant that uses planar structural data to control the RBF gradient. The RBF gradient resembles the geology orientation, which makes form interpolants useful for visualising structural data and identifying broad trends in 3D. The form interpolant's meshes can then be used to control other surfaces in the project.

This topic describes how to work with form interpolants in Leapfrog Geothermal. It covers:

- [Creating a Form Interpolant](#)
- [The Form Interpolant in the Project Tree](#)
- [Form Interpolant Statistics](#)

Once a form interpolant has been created, experiment with different **Distance** values. To do this, double-click on the interpolant in the project tree and click on the **Outputs** tab.

Creating a Form Interpolant

To create a form interpolant, right-click on the **Form Interpolants** folder (in the **Structural Modelling** folder) and select **New Form Interpolant**. In the window that appears, click the **Add** button to add structural data tables to the interpolant:

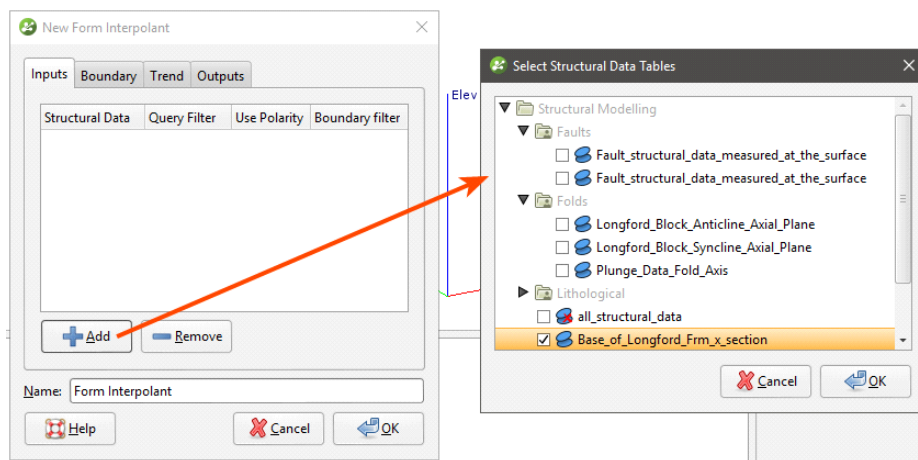

Data can be filtered using the query filters defined for the selected structural data tables:

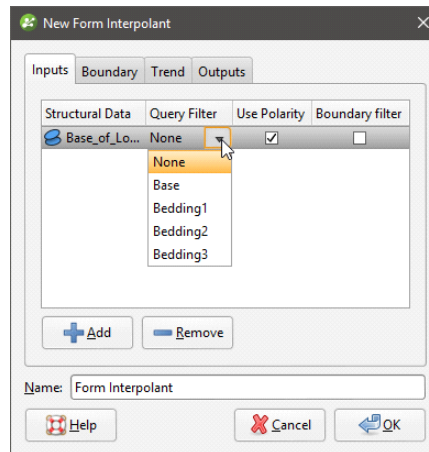

Once you have created the interpolant, you can easily add and remove structural data tables and change the filtering.

When generating the form interpolant, you can use the tangents and polarity or only the tangents. To use both, leave the **Use Polarity** box ticked. To use only the tangents, untick the box.

The **Boundary filter** setting determines how data is handled when it lies outside the interpolant's boundary:

- **Boundary filter** enabled. The interpolant is only influenced by the data that falls inside the boundary.
- **Boundary filter** disabled. The interpolant is influenced by the data both inside and outside the boundary.

Setting a Trend

In the **Trend** tab, you can set a trend using the moving plane or by entering the required values. You can also use the **Set to** list to choose different options used in the project. **Isotropic** is the default option used when the function is created.

The **Ellipsoid Ratios** determine the relative shape and strength of the ellipsoids in the scene, where:

- The **Maximum** value is the relative strength in the direction of the green line on the moving plane.
- The **Intermed.** value is the relative strength in the direction perpendicular to the green line on the moving plane.
- The **Minimum** value is the relative strength in the direction orthogonal to the plane.

Adding Isosurfaces

The isosurfaces generated for the form interpolant are determined by the settings in the **Outputs** tab. If you wish to add more isosurfaces to the interpolant, click the **Add** button and enter the required **Iso Value**. Click on an isosurface and then on the **Remove** button to delete it. The **Default resolution** setting is used for all new isosurfaces.

The Form Interpolant in the Project Tree

In the project tree, the form interpolant contains objects that represent different parts of the interpolant:

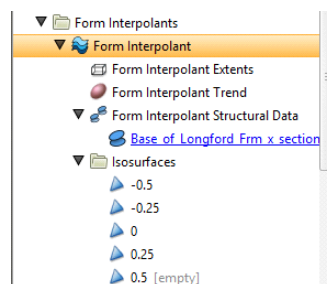

- The **Extents** object represents the interpolant's boundary settings, from the **Boundary** tab.
- The **Trend** object describes the trend applied in the interpolant. See [Global Trends](#) for more information.
- The structural data object (🔗) contains a link to the data used in generating the interpolant. See [Form Interpolant Statistics](#) for more information.
- The **Isosurfaces** folder contains the isosurfaces defined in the **Outputs** tab.

To display the form interpolant:

- Drag the interpolant into the scene.
- Right-click on the interpolant and select **View Isosurfaces**.

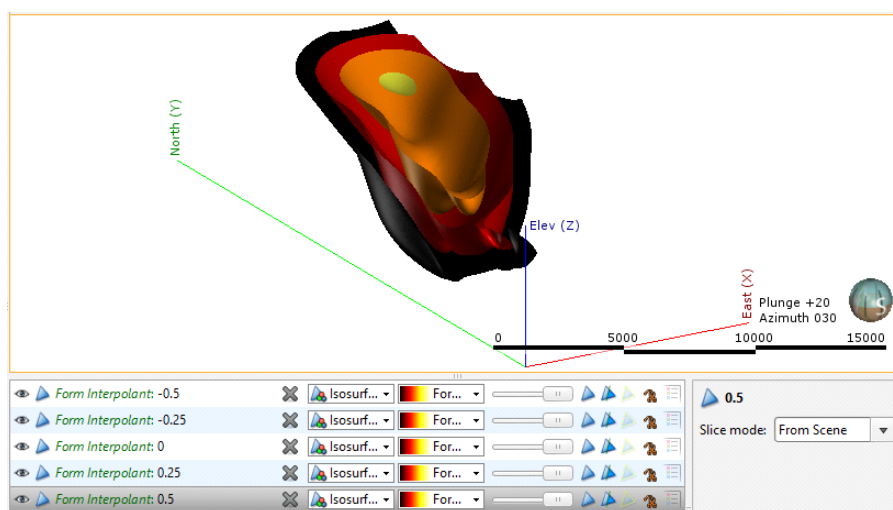

Form Interpolant Statistics

To view information about the data used for the form interpolant, right-click on the structural data object (📌) under the interpolant and select **Properties**. The **General** tab includes information about how the data has been declustered:

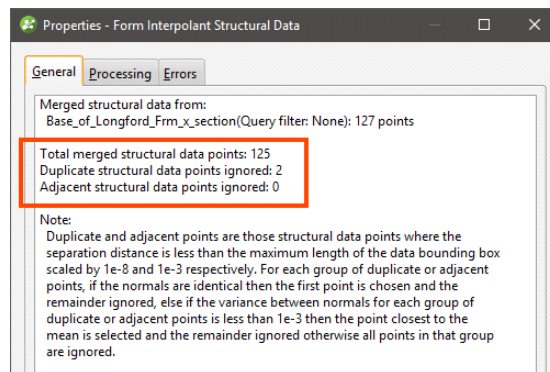

You cannot change how data is declustered in the form interpolant, but if you wish to have more control over this, create a declustered structural data set and use it as the input for the form interpolant. See [Declustering Planar Structural Data](#) for more information.

Planning Wells

In Leapfrog Geothermal, you can plan wells, view prognoses for models in the project and export planned wells in .csv format.

Planned wells are added to a project from the **Planned Wells** folder, which is in the **Well Data** folder. When displayed in the scene, the planned well is made up of a collar point, a target location and a path defined by lift and drift parameters.

The rest of this topic is divided into:

- [Adding Planned Wells](#)
- [Planning Options](#)
- [Drilling Prognoses](#)
- [Exporting Planned Wells](#)

Adding Planned Wells

To plan a well, right-click on the **Planned Wells** folder and select **Plan Well**. The **Well Planning** window will appear:

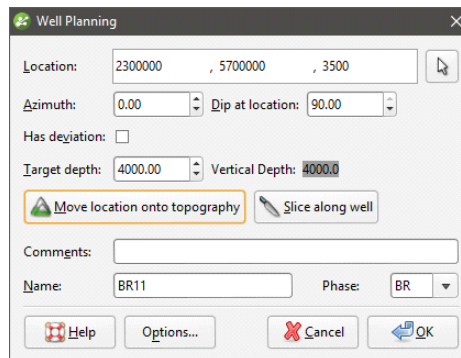

If the well deviates, tick **Has Deviation** to enter information about the **Kickoff depth**, **Build-up rate** and **Target depth**:

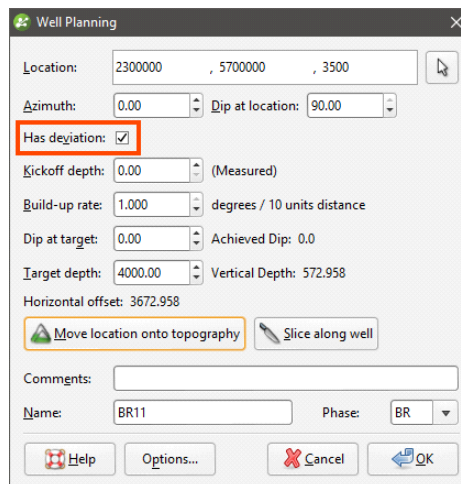

If a **Kickoff depth** greater than the **Target depth** is entered, the **Target depth** will be updated to reflect the new value.

When the planned well is positioned as required, click **OK** to finish.

Planned wells will appear in the **Planned Wells** folder. You can change a planned well by right-clicking on it and selecting **Edit Well**.

Planning Options

In the **Well Planning Options** window, you can change the maximum build-up rate permissible in the **Well Planning** window. To open this window, click the Options button in the **Well Planning** window:

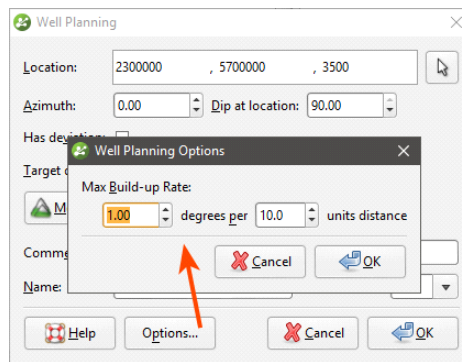

Enter the information required and click **OK** to return to the **Well Planning** window. The new settings will be applied to the next new planned well added to the project.

Drilling Prognoses

Planned wells can be evaluated against any model in the project. To view drilling prognoses for a well, right-click on it and select **Drilling Prognoses**. The **Drilling Prognoses** window will appear:

Measured From	Measured To	Vertical From	Vertical To	Faulted GM	Bu
0	120.995	0	120.995	Superficial deposits	0
120.995	285.614	120.995	285.614	Ignimbrite 2	0
285.614	696.14	285.614	696.14	Andesite	0
696.14	963.303	696.14	963.303	Ignimbrite 2	0
963.303	1680.82	963.303	1680.82	Sediments	0
1680.82	1861.58	1680.82	1861.58	Ignimbrite 1	0
1861.58	2598.83	1861.58	2598.83	Rhyolite	0
2598.83	2805.55	2598.83	2805.55	Lake sediments	0
2805.55	3000	2805.55	3000	Basement	0

You can display prognoses for different models by selecting them from the list. For numeric models, you can view a plot of the data by clicking on the **Plot** tab.

In each tab, you can copy the information displayed to your computer's clipboard by clicking the **Copy to Clipboard** button. The information in the **Data** tab will be copied as tab delimited text, which can be copied into a spreadsheet application such as Excel. The plot displayed in the **Plot** tab will be copied as a bitmap image.

Exporting Planned Wells

To export a planned well, right-click on it in the project tree and select **Export**. You will be prompted for a filename and location.

Modelling

This section describes how to build models in Leapfrog Geothermal.

- Geological models can be built from lithology data or from any other suitable data in the project. Visualising data in the scene is an important step in determining the model that will be built, and the tools for doing this are described in [Visualising Data](#). Once this has been determined, the next step is to define a basic geological model and refine its boundaries. Modelling contact surfaces and setting their cutting relationships determine how the basic model volume is divided into lithologies. Models can also have a fault system that, once activated, will subdivide the model into fault blocks.
- With the **Numeric Models** folder, you can interpolate downhole numeric data, composited well data and points data.
- Combined models use information from up to four geological models, interpolants and distance functions in order to visualise relationships between different types of data in the project.
- Geological models created in Leapfrog Geothermal can be used as the basis for MODFLOW, FEFLOW and TOUGH2 models. You can create flow models directly in Leapfrog Geothermal and assign hydrological/material properties based on the lithologies in the geological model. Flow models can be exported for use in other applications, and you can import existing flow models and use them as the basis for the construction of new models. Flow models can be displayed in the scene, and time-dependent output data can also be visualised.
- Leapfrog Geothermal can import Isatis files, UBC grids, Gocad models, Magnetotelluric resistivity files and block models in CSV format. Block models imported in CSV format must be regular, rotated only about the Z axis. Block models and sub-blocked models can also be created directly in Leapfrog Geothermal and exported for use in other applications. Creating block models within Leapfrog Geothermal has the advantage that the resolution can easily be changed. Geological models and interpolants can be evaluated on block models, as described in [Evaluations](#) below.

Evaluations

In Leapfrog Geothermal, models can be evaluated onto other objects in the project. To do this, right-click on an object and select **Evaluations**:

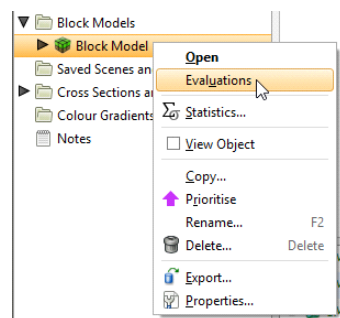

See [Back-Flagging Well Data](#) for information on evaluating wells on geological models.
 See [Evaluating on Sections](#) for information on evaluating surfaces on cross sections and fence sections.
 See [Evaluating Points Data](#) for information on evaluating surfaces on points.

A window will appear listing all objects in the project that can be used for an evaluation. Once you have selected one or more objects, click **OK**.

The evaluations will be added to the object in the project tree:

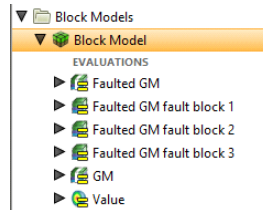

When you display objects in the scene, you can select the evaluations from the view list:

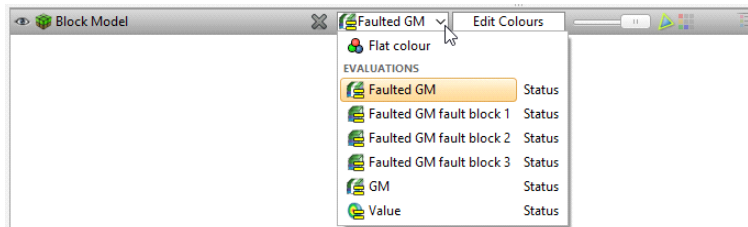

Assigning Attributes to Volumes

For geological models, numeric models and combined models, you can assign attributes to the model volumes. To do this, right-click on the model in the project tree and select **Volume Attributes**. In the window that appears, click the **Add Attribute** button to add a new column.

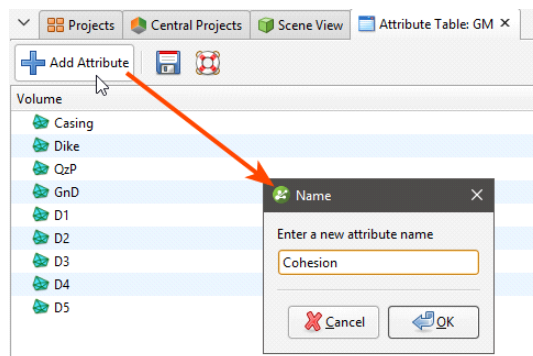

Enter a name for the column and click **OK**. You can then edit the values in the table. When you click in the scene, the values will be included in the information displayed about the selected volume:

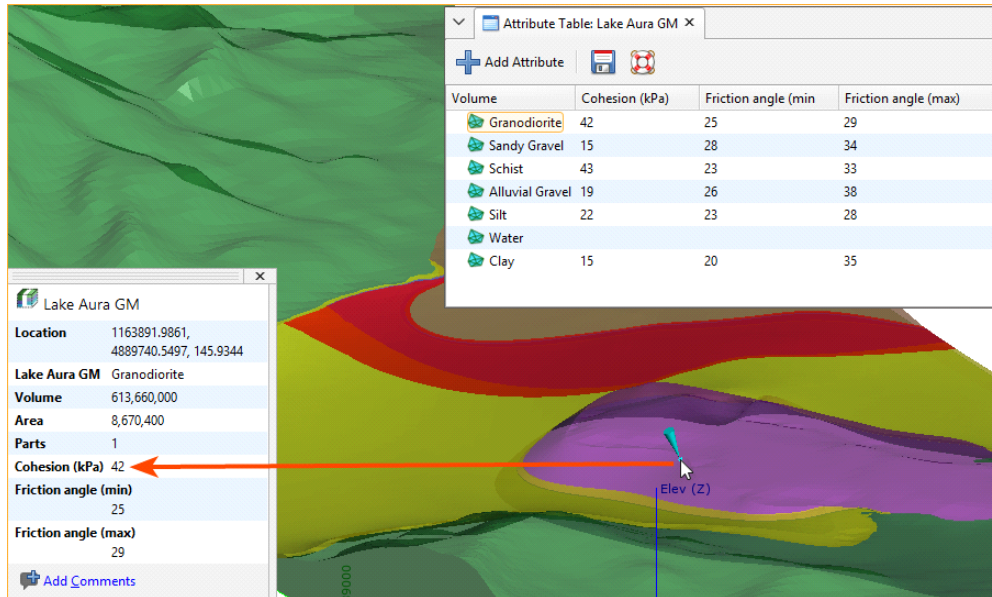

Attribute information cannot be displayed in the Central Browser.

When you save scenes for viewing in Leapfrog Viewer, manually entered attributes will be displayed when volume information is displayed.

Geological Models

The model building process involves several key steps:

- Creating the project and setting up the modelling environment
- Importing well data and correcting errors
- Importing other required data
- Visualising the data in the scene and inspecting it to make sense of the model that will be built. It is at this stage that you might create new well data columns to select data that will be the basis of geological models.
- Creating a basic GM, then refining its boundary and defining a fault system
- Modelling the contact surfaces
- Setting the cutting relationships between the different contact surfaces and generating volumes

A fault system can also be defined that divides the geological model into subunits in which the internal structure can be defined independent of the other subunits in the model. This is described in [Faulted Models](#).

The rest of this topic describes the process of creating a geological model. It is divided into:

- [Creating a New Geological Model](#)
- [The Geological Model in the Project Tree](#)
- [Geological Model Display](#)
- [Copying a Geological Model](#)
- [Creating a Static Copy of a Geological Model](#)
- [Geological Model Volumes and Surfaces Export Options](#)
- [Extracting Model Volumes](#)

A geological model can be created using only a basic set of parameters. The only parameter that cannot be changed once the model has been created is the base lithology.

Creating a New Geological Model

To create a new geological model, right-click on the **Geological Models** folder and select **New Geological Model**. The **New Geological Model** window will open, together with a set of controls in the scene that help in defining the model extents.

The Base Lithology

Select the well data column that will be used as the basis of a model from the **Base Lithology Column** list. If you do not wish to use lithology data as the basis for the model, select **<None>**. This may be the case if, for example, you want to build a model from points data or from an

imported map. If you select **<None>**, you will need to manually define the lithologies that will be modelled.

If more than one column of lithology data is available for creating models, be sure to choose the correct one as it cannot be changed once the initial model has been created. If after creating and modifying the model, you find you need to modify the well data, resulting in a new lithology column, you can use that new column to create contact surfaces using **Other Contacts** options.

You can also filter the well data used to build the geological model using query filters. To do so, select the required query filter from the **Filter data** list. Once the model has been created, you can remove the filter or select a different filter.

Surface Resolution

The surface resolution setting Leapfrog Geothermal automatically uses as the default is based on the data available in the project. Set the surface resolution for the model as a whole and choose whether or not the resolution will be adaptive. See [Surface Resolution in Leapfrog Geothermal](#) for more information on the effects of these settings.

Later, while refining the model, you can change the resolution of each surface and enable or disable adaptive resolution. See [Surface Resolution for a Geological Model](#).

Model Extents

A geological model is initially created with a basic rectangular set of extents aligned with the south/north and east/west axes. You can define the model's extents in three ways:

- Enter the coordinates.
- Select **Enclose Object** and choose from the list of objects in the project. If the model is based on well data, select the lithology segments from the **Enclose Object** list.
- Use the controls that appear in the scene. The orange handle adjusts the centre of the plane and the red handles adjust the size.

See [Object Extents](#) for more information.

Enter a **Name** for the model that describes the purpose of the model. This **Name** will be used in naming the objects that will be added to the model. Click **OK** to create the new model. The new geological model will be created and added to the **Geological Models** folder.

See [Editing a Geological Model](#) for information on how to change the basic settings for the model.

The Geological Model in the Project Tree

The objects under the geological model in the project tree represent different parts of the model:

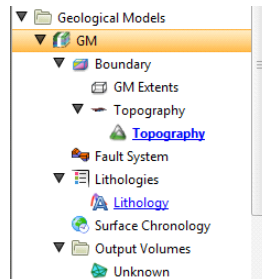

- The **Boundary** object defines the limits of the geological model. When the model is first created, this is the rectangular model extents. If a topography has been defined, it is automatically used for as the upper boundary. See [Modifying a Geological Model's Boundary](#) for more information about modifying the boundary.
- The **Fault System** object defines faults and their interactions in the model. See [Faulted Models](#).
- The **Lithologies** object describes all the lithological units to be modelled and the colours that are used to display them on the screen. It is generated automatically from all the lithologies identified in well data selected when the model is created. If no column was selected, you will need to define the lithologies manually before you start modelling the lithology layers.
- The **Surface Chronology** object describes the contact surfaces in the model, organised in chronological order, from youngest to oldest. These surfaces and their chronology determine how the volume inside the model extents is divided into lithological units. When the model is first created, the **Surface Chronology** is empty, but it will eventually hold all contact surfaces and inputs to them.
- The **Output Volumes** folder contains all the volumes generated in building the geological model. When the model is first created, the **Surface Chronology** is empty and so there is only a single output volume in the **Output Volumes** folder. This volume fills the model's extents and is called "Unknown". Once contact surfaces have been generated and added to the **Surface Chronology** object, new volumes will be generated and added to the **Output Volumes** folder.

Geological Model Display

Right-click on the geological model in the project tree to view its display options:

- The **View Object** option adds the geological model to the shape list as a single object. You can also display the geological model in this way by dragging it from the project tree into the scene. Change the visibility of the model's volumes by clicking the **Edit Colours** button in the shape list.

- The **View Output Volumes** option adds the model to the scene as a series of output volumes. It is the equivalent of dragging the **Output Volumes** folder into the scene. Change the visibility of the model's volumes individually.
- The **View Surface Chronology** option displays the surfaces that are used to divided up the model.
- The **View Fault Block Boundaries** option is only available when a fault system has been defined and enabled for the model. Selecting **View Fault Block Boundaries** displays the fault blocks without displaying the lithology layers.

Copying a Geological Model

Creating a copy of a geological model is a useful way of experimenting with changes to a model.

To copy a geological model, right-click on it in the project tree and select **Copy**. Enter a name for the copy of the model and click **OK**. The copy will be added to the project tree.

Creating a Static Copy of a Geological Model

Creating a static copy preserves a snapshot of a geological model that does not change, even when changes are made to the data on which the original model was dependent. This is a useful way of storing historical models and comparing models. Static copies can be exported from Leapfrog Geothermal, as described in [Geological Model Volumes and Surfaces Export Options](#) below.

To create a static copy of a geological model, right-click on it in the project tree and select **Static Copy**. Enter a name for the copy of the model and click **OK**. The copy will be added to the **Geological Models** folder.

In the project tree, the static copy (🌐) is made up of a **Legend** object (📄), the output volumes (🌐) and all surfaces created in building the model.

Static models created in versions of Leapfrog Geothermal before 2.8 copied only the output volumes and the legend, and the static model appeared in the shape list only as a single line. When these static models are upgraded and displayed in the scene, the individual output volumes will be added to the shape list.

To view the date a static copy was created, right-click on it in the project tree and select **Properties**. The date the copy was created is shown in the **General** tab.

Geological Model Volumes and Surfaces Export Options

There are three options for exporting a geological model's output volumes and surfaces. These are:

- Export an output volume or a surface as a mesh. Right-click on it in the project tree and click **Export**. You will be prompted for a file name and location. See [Exporting a Single Mesh](#).

- Export an output volume as a thickness grid. Right-click on it in the project tree and click **Export Thickness Grid**. See [Thickness Grids](#).
- Export multiple output volumes and surfaces. Right-click on the geological model in the project tree and select **Export**. See [Exporting Multiple Meshes from Models](#).

When exporting output volumes, the **Merge output lithology volumes** setting in the geological model's **General** tab (see [Editing a Geological Model](#)) determines how the output volumes are handled when they are exported. If this setting is enabled, internal walls and surface seams will be removed from volumes of the same lithology.

Extracting Model Volumes

There are number of options for extracting meshes from geological model output volumes. These options are available by right-clicking on volumes in the **Output Volumes** folder and selecting **Extract Mesh**. There are five options:

- **Mesh Parts**
- **Component Surfaces**
- **Younger Surfaces**
- **Older Surfaces**
- **Boundary Surfaces**

The **Mesh Parts** option is the same as the option available on meshes elsewhere in the project. See [Extracting Mesh Parts](#).

The **Younger Surfaces**, **Older Surfaces** and **Boundary Surfaces** options extract different parts of the selected volume, which are saved into the **Meshes** folder. Here, the boundary surfaces are shown in blue, the younger surfaces in yellow and the older surfaces in purple:

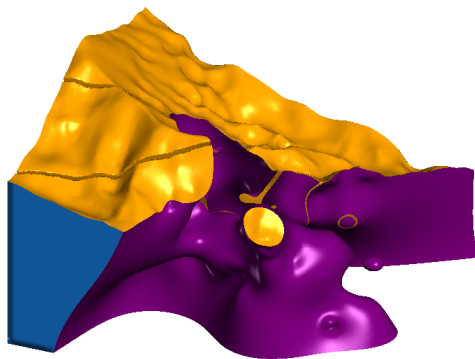

Component Surfaces extracts a separate surface for each volume the selected volume interacts with, including the boundary. The component surfaces are named after the boundary they are derived from and saved into a subfolder in the **Meshes** folder. For example, here meshes have been extracted for each contact with the Intermineral diorite volume:

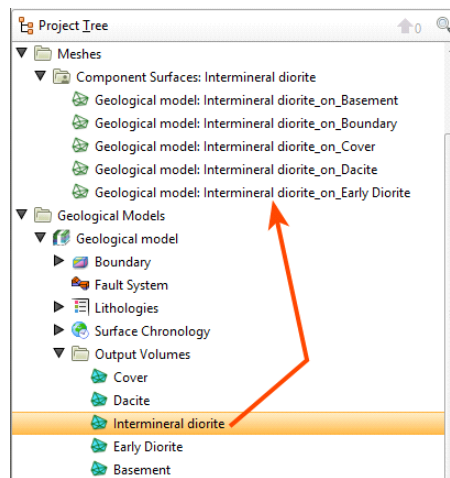

Editing a Geological Model

Once a geological model has been created, you can change the model's resolution and other basic settings by double-clicking on the model in the project tree. The **Geological Model** window will open with the **General** tab selected. The other tabs in the **Geological Model** window represent the different parts of the geological model. It is generally more useful, however, to work with these parts of the model on an individual basis by either double-clicking on the object in the project tree or right-clicking and seeing what options are available.

The rest of this topic describes how to change the basic settings for a geological model. It is divided into:

- [Changing the Query Filter](#)
- [Surface Generation Options](#)
- [Volume Generation Options](#)

Changing the Query Filter

Although the **Base lithology column** cannot be changed once a geological model has been created, you can change the filters applied to the data. Any filters defined for the lithology table used to define the model can be applied to the **Base lithology column**:

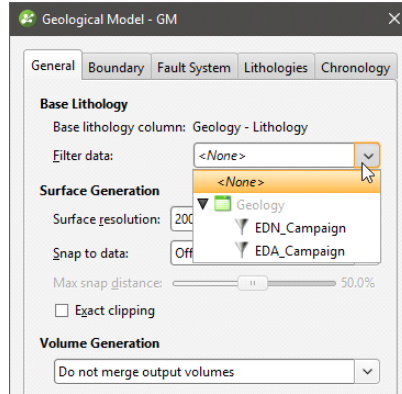

Individual surfaces in the geological model can inherit the query filter from the parent geological model or can use a different filter. To change what query filter is used for a surface, double-click on the points used to create the surface and change the **Query filter** setting in the **Lithology** tab:

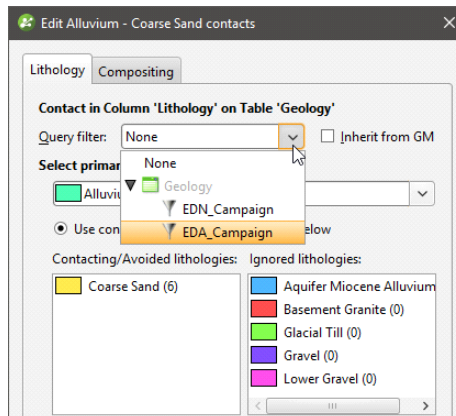

You may first need to disable the **Inherit from GM** option to change the **Query filter**.

Surface Generation Options

The **Surface Generation** options apply to the model as whole, but can be overridden for individual surfaces.

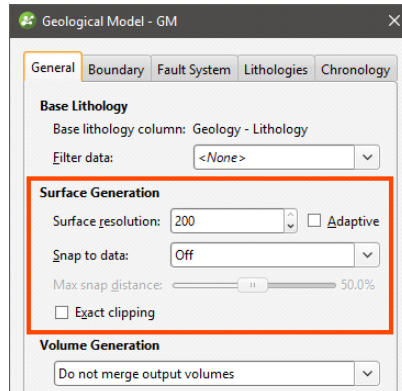

See [Surface Resolution for a Geological Model](#) for information on changing the **Surface resolution** and **Adaptive** settings for individual surfaces.

When **Exact clipping** is enabled, model surfaces will be generated without “tags” that overhang the model boundary. This setting is enabled by default when you create geological model.

Surfaces created in building the geological model can be set to snap to the data used in the model. There are three options:

- **Off.** Surfaces do not snap to the data used to create them.
- **All data.** Surfaces snap to all data within the **Maximum snap distance**, which includes well data and any data added to surfaces as part of the model refinement process.
- **Drilling only.** Surfaces snap to well data within the **Maximum snap distance** but not to other data used to modify surfaces.

Take care in enabling snapping and in selecting what data the surface will snap to, as the more data you include, e.g. by setting a large **Maximum snap distance** or selecting **All data** for **Snap to data**, the greater the possibility that errors in the data or assumptions inherent in interpretations (e.g. polylines) will cause distortions in the meshes. If you do enable snapping, it is best to snap only to drilling data. See [Honouring Surface Contacts](#) for more information on these settings.

If you need surfaces to honour well data but treat other data objects as interpretations, select **Drilling only**. If you want finer control over what objects are snapped to, you can do this on a surface-by-surface basis. See:

- [Surfacing Options for Deposits and Erosions](#)
- [Surfacing Options for Intrusions](#)
- [Surfacing Options for Veins](#)
- [Changing Surfacing Options for an Offset Surface](#)
- [Surfacing Options for a Structural Surface](#)

Volume Generation Options

The **Merge output volumes** setting determines whether or not output volumes of the same lithology are merged when the volumes are exported. If **Merge output volumes** is set to **Fast** or **Robust**, internal walls and surface seams will be removed from volumes of the same lithology. Either option is suitable when you are using output volumes as extents for other models.

The difference between **Fast** and **Robust** is the algorithm used:

- **Fast** removes back-to-back triangles before generating output volumes. This option was new in Leapfrog Geothermal version 3.2 and is the default option selected when a geological model is created.
- **Robust** is the **Merge output lithology volumes** option from versions of Leapfrog Geothermal before 3.2. **Robust** uses the volume cutter, which tracks where the triangles originated and is, therefore, a slow option for building output volumes.

If there are issues with surfaces exported to other modelling packages using the **Do not merge output volumes** setting, try the **Fast** setting. If there are still issues, try the **Robust** setting.

When projects created in earlier versions of Leapfrog Geothermal are opened in Leapfrog Geothermal 3.8, the **Volume Generation** setting for any existing geological models will not be changed.

Surface Resolution for a Geological Model

When you create a geological model (see [Creating a New Geological Model](#)), the surface resolution is set for the model as a whole. When surfaces and boundaries are created as part of the model-building process, their resolution is inherited from the geological model:

- For deposit and erosion contact surfaces, stratigraphic sequences and model boundaries, the resolution is the same as the geological model.
- For intrusion contact surfaces, the resolution is half that set for the geological model.
- For vein contact surfaces, the resolution is the same as the geological model, but the **Adaptive** option does not apply.

You can change the resolution and enable or disable the adaptive isosurfer on a surface-by-surface basis. This is useful if you want to build a detailed model of some lithologies without increasing processing time for other volumes.

To change the resolution settings for a contact surface, double-click on the surface in the project tree, then click on the **Surfacing** tab:

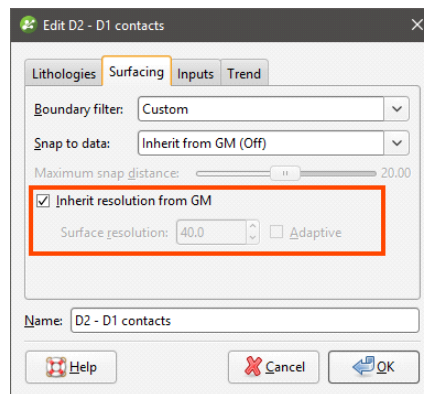

For a lateral extent or fault, simply double-click on the surface in the project tree to change its resolution settings.

Untick the **Inherit resolution from GM** box to change the resolution settings for a surface. This setting may be disabled, depending on the data used to create the boundary or surface.

The resolution of intrusion contact surfaces is also affected by the point generation parameters. See [Intrusion Point Generation Parameters](#) for more information.

Modifying a Geological Model's Boundary

Geological models are created with a basic set of rectangular extents that can then be refined using other data in the project. These extents usually correspond to the ground surface and known boundaries. Creating extents can also be used to restrict modelling to a particular area of interest; for example, modelling can be restricted to a known distance from wells by applying a distance function as a lateral extent. Extents do not need to be strictly vertical surfaces, and can be model volumes. It is also possible to define a base that serves as the geological model's base.

When a topography is defined for the project, it will be automatically applied as a geological model's upper boundary when the model is created.

The rest of this topic describes how to create and work with geological model extents. It is divided into:

- [Creating Extents for a Geological Model](#)
- [Changing an Extent's Settings](#)
- [Adding Data to an Extent](#)
- [Editing an Extent with a Polyline](#)
- [Editing an Extent with Structural Data](#)
- [Removing an Extent from a Geological Model](#)

Creating Extents for a Geological Model

To create an extent, expand the geological model in the project tree. Right-click on the **Boundary** object and select from the **New Lateral Extent** or **New Base** options. Follow the prompts to create the extent, which will then appear in the project tree under the model's **Boundary** object. For example, this geological model has two lateral extents, one from a polyline and the other from GIS data:

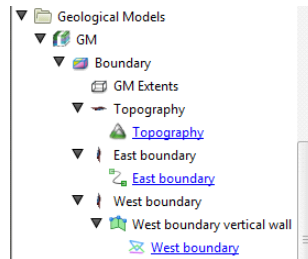

New extents are automatically applied to the boundary being modified. Leapfrog Geothermal usually orients a new extent correctly, with red presenting the inside face of the extent and blue representing the outside face. If this is not the case, you can change the orientation by right-clicking on the extent in the project tree and selecting **Swap Inside**.

Extent From a Polyline

You can create an extent from a polyline that already exists in the project or you can draw a new one. If you want to use an imported polyline, import it into the **Polylines** folder before creating the new extent.

To create a new extent from a polyline, right-click on the model's **Boundary** object and select **New Lateral Extent > From Polyline** or **New Base > From Polyline**. In the window that appears, select whether you will create a new polyline or use an existing one:

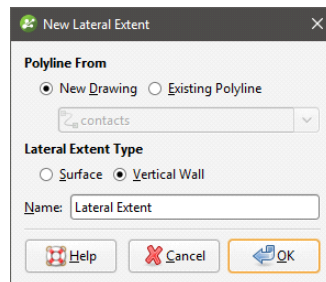

For lateral extents, you can create the extent as a **Vertical Wall** or **Surface**. If you create the lateral extent as a **Surface**, you will be able to modify it using additional data, as described below. A lateral extent created as a **Vertical Wall**, however, cannot be modified. A base is always created as a surface and so can be modified as described below.

Click **OK** to generate the new extent. If you have chosen to create a **New Drawing**, the drawing controls will appear in the scene and you can begin drawing, as described in [Drawing in the Scene](#).

The new extent will appear in the project tree as part of the **Boundary** object.

If the surface generated does not fit the polyline adequately, you can increase the quality of the fit by adding more points to the polyline. See [Drawing in the Scene](#) for information on adding points to polylines.

Extents created from polylines can be modified by adding points data, GIS vector data and structural data. You can also add polylines and structural data to the extent. See [Adding Data to an Extent](#), [Editing an Extent with a Polyline](#) and [Editing an Extent with Structural Data](#) for more information.

Extent From GIS Vector Data

GIS data in the project can be used to create a lateral extent or a base for a geological model. Once the data you wish to use has been imported into the project, right-click on the model's **Boundary** object and select **New Lateral Extent > From GIS Vector Data** or **New Base > From GIS Vector Data**.

In the window that appears, select the data object you wish to use:

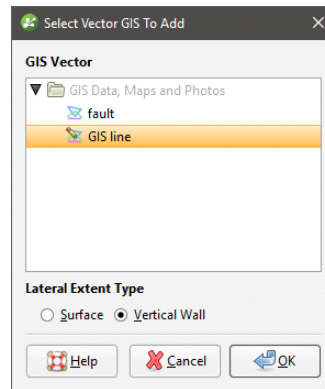

For lateral extents, you can create the extent as a **Vertical Wall** or **Surface**. If you create the lateral extent as a **Surface**, you will be able to modify it using additional data, as described below. A lateral extent created as a **Vertical Wall**, however, cannot be modified. A base is always created as a surface and so can be modified as described below.

If you select the **Surface** option, you can use the GIS data object with its own elevation data or projected onto the topography:

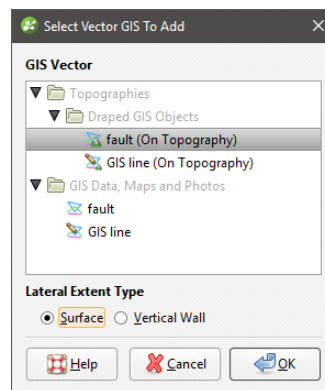

Using the **On Topography** option makes sense for GIS data as it is, by nature, on the topography. The **On Topography** option also mitigates any issues that may occur if elevation information in the GIS data object conflicts with that in the project.

Click **OK** to create the new extent. The new extent will appear in the project tree as part of the **Boundary** object.

Extents created from GIS data can be modified by adding points data, GIS vector data and structural data. You can also add polylines and structural data to the extent. See [Adding Data to an Extent](#), [Editing an Extent with a Polyline](#) and [Editing an Extent with Structural Data](#) for more information.

Extent From Points

To create a new extent from points data, right-click on the **Boundary** object for the model you are working on and select **New Lateral Extent > From Points** or **New Base > From Points**. The **Select Points To Add** window will be displayed, showing points data available in the project:

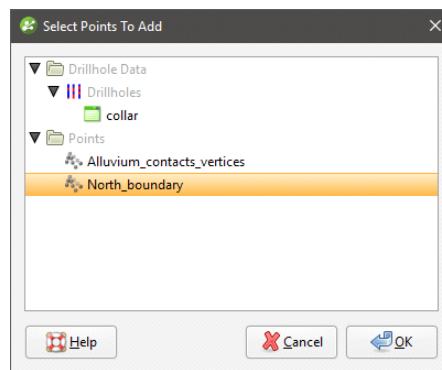

Select the information you wish to use and click **OK**.

The new extent will appear in the project tree as part of the **Boundary** object.

Extents created from points can be modified by adding points data, GIS vector data and structural data. You can also add polylines and structural data to the extent. See [Adding Data to an Extent](#), [Editing an Extent with a Polyline](#) and [Editing an Extent with Structural Data](#) for more information.

Extent From Structural Data

Planar structural data can be used to create a lateral extent or a base for a geological model. You can create a new structural data table or use a table that already exists in the project. If you want to use categories of structural data in creating the extent, use an existing table and create filters for those categories before creating the lateral extent.

To start, right-click on the **Boundary** object for the model you are working on and select **New Lateral Extent > From Structural Data** or **New Base > From Structural Data**. The **New Structural Data** window will be displayed, showing structural data available in the project:

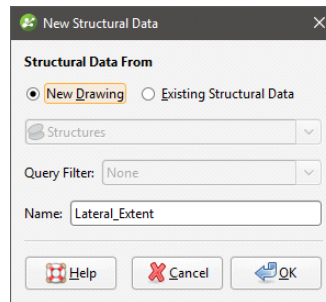

Select the **New Drawing** option to draw the structural data points directly in the scene.

Select the **Existing Structural Data** option to use a table in the **Structural Modelling** folder. With this option, you will be able to select from the categories available in the data table, if query filters have been created for those categories:

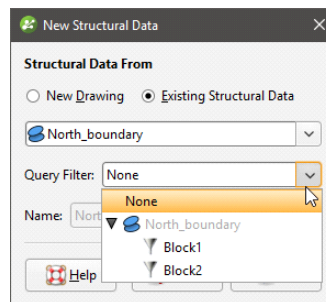

Click **OK** to generate the new extent. If you have chosen to create a **New Drawing**, the drawing controls will appear in the scene and you can begin drawing, as described in [Creating New Planar Structural Data Tables](#). To share the new structural data table, right-click on it and select **Share**. The table will be saved to the **Structural Modelling** folder.

The new extent will appear in the project tree as part of the **Boundary** object.

Extents created from structural data can be modified by adding points data, GIS vector data and structural data. You can also add polylines and structural data to the extent. See [Adding Data to an Extent](#), [Editing an Extent with a Polyline](#) and [Editing an Extent with Structural Data](#) for more information.

Extent From a Surface

To use a surface as an extent for a geological model, right-click on the model's **Boundary** object and select **New Lateral Extent > From Surface** or **New Base > From Surface**. The **Select Boundary** window will appear, showing all the meshes that can be used as an extent:

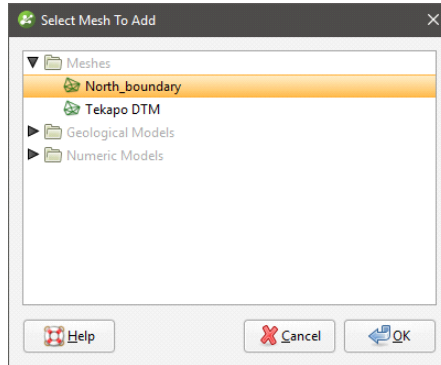

Select the required mesh and click **OK**. The extent will be added to the model's **Boundary** object.

You cannot modify an extent created from a mesh by adding data, editing with polylines or structural data or by applying a trend. However, the extent is linked to the mesh used to create it, and updating the mesh will update the extent.

Extent From Distance to Points

Leapfrog Geothermal can calculate the distance to set of points and use the resulting distance buffer as a lateral extent for a geological model. To create a new lateral extent from a distance buffer, right-click on the **Boundary** object for the model you are working on and select **New Lateral Extent > From Distance To Points**. The **Smoothed Distance Buffer** window will appear:

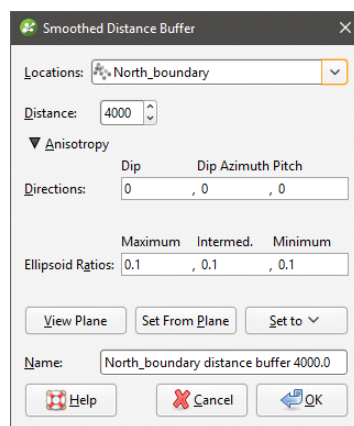

Select the **Distance** and set an **Anisotropy**, if required.

The **Ellipsoid Ratios** determine the relative shape and strength of the ellipsoids in the scene, where:

- The **Maximum** value is the relative strength in the direction of the green line on the moving plane.

- The **Intermed.** value is the relative strength in the direction perpendicular to the green line on the moving plane.
- The **Minimum** value is the relative strength in the direction orthogonal to the plane.

You can also use the **Set to** list to choose different options Leapfrog Geothermal has generated based on the data used to build the model. **Isotropic** is the default option used when the model is created.

Click **OK** to create the new extent, which will appear in the project tree as part of the **Boundary** object.

To change the extent's settings, expand the model's **Boundary** object in the project tree and double-click on the extent. Adjust the **Distance** and **Anisotropy**, if required.

The resolution of extents is automatically inherited from the geological model. You can change the resolution for an extent if you want more or less detail than for the geological model as a whole. To do so, untick the box for **Inherit resolution from GM** and change the setting.

Extents created from a distance to points function can be modified by adding points data and GIS vector data. See [Adding Data to an Extent](#).

Extent From a Distance Function

A distance function calculates the distance to a set of points and can be used to bound a geological model. You can use an existing distance function as a lateral extent or create a new one.

To use a distance function as a lateral extent, right-click on the **Boundary** object for the model you are working on and select **New Lateral Extent > From Distance Function**. If there are no distance functions in the project, you will be prompted to create a new one. See [Distance Functions](#) for information on defining and editing the distance function.

When there are already distance functions in the project, you will be prompted to choose between creating a new function or using an existing one:

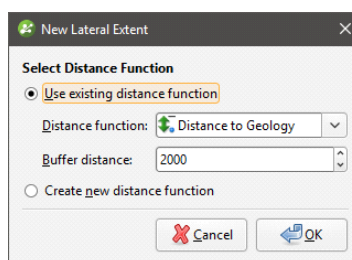

To use an existing function, select it from the list and set a **Buffer distance**. Click **OK** to create the lateral extent.

When you create a new distance function, it will be part of the model's **Boundary** object and will not be available elsewhere in the project. To share it within the project, expand the lateral extent in the project tree and right-click on the distance function. Select **Share**. The distance function will be saved to the **Numeric Models** folder.

To change the extent's settings, expand the model's **Boundary** object in the project tree and double-click on the extent. The **Edit Distance Buffer** window will appear.

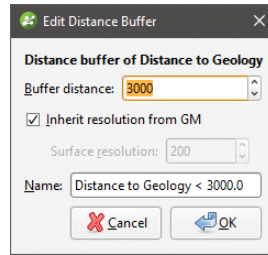

The resolution of extents is automatically inherited from the geological model. You can change the resolution for an extent if you want more or less detail than for the geological model as a whole. To do so, untick the box for **Inherit resolution from GM** and change the setting.

Base From Lithology Contacts

To create a base from lithology contacts, right-click on the **Boundary** object and select either **New Base > From Base Lithology** or **New Base > From Other Contacts**.

The only difference in the two methods is that when creating a base from other contacts, you must first select the lithology column from those available in the project.

When defining the base, select the primary lithology and the contacts to use:

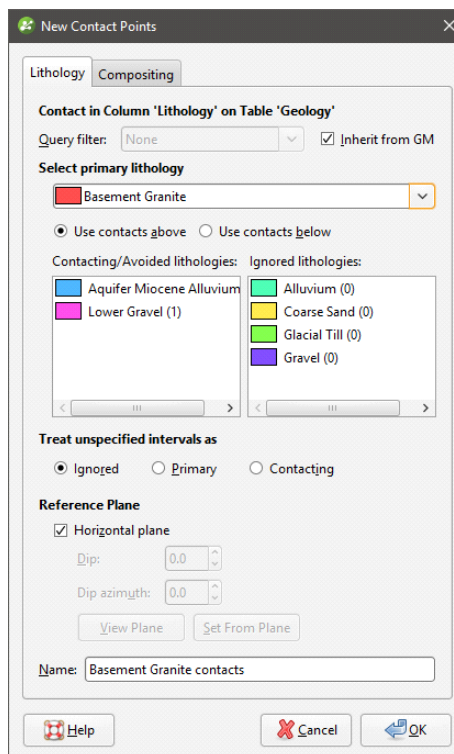

For complex geologies, the up and down directions for the base may not be clear. If this is the case, untick the **Horizontal Plane** box. A reference plane will appear in the scene, with the up-facing surface labelled A and the downward-facing surface labelled B. Controlling the position of the reference plane is similar to controlling the position of the moving plane:

- Use the handles in the scene window to move the plane.
- Set the **Dip** and **Dip Azimuth** values in the **New Contact Points** window. The reference plane will be updated in the scene.

Once the reference plane is correctly oriented, click the **Set From Plane** button.

Click **OK** to create the base, which will appear under the **Boundary** object. The new base will automatically be added to the model.

Each geological model can have only one base defined, so if you wish to define a new base, you must first delete the existing base from the model. Do this by right-clicking on the **Base** object and selecting **Delete**. You can also choose not to use the base you have defined. See [Removing an Extent from a Geological Model](#) for more information.

Changing an Extent's Settings

For geological model extents created from from polylines, GIS data, points and structural data, you can change the extent's settings by double-clicking on it in the project tree.

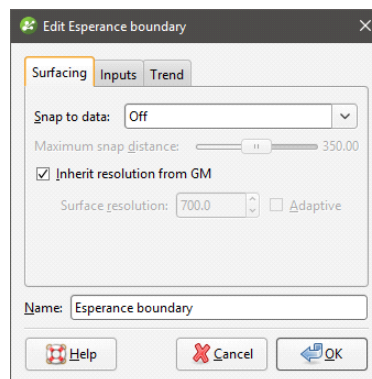

In the **Surfacing** tab, you can change surface resolution and contact honouring options, which are described below. In the **Trend** tab, you can apply a trend to the extent, which is described in [Applying a Trend](#).

Surface Resolution

For geological models, the resolution of extents and whether or not the adaptive isosurfer is used is automatically inherited from the geological model. You can change these settings for an extent if you want more or less detail than for the geological model as a whole. To do so, untick the box for **Inherit resolution from GM** and make the required changes.

Contact Honouring

Often, surfaces should honour well data and treat data objects such as polylines and GIS data as interpretations. For extents, the **Snap to data** setting in the **Surfacing** tab determines whether or not the extent honours the data used to create it. Options are:

- **Off.** The extent does not snap to the data used to create it. This is the default setting.
- **All data.** The extent snaps to all data within the **Maximum snap distance**, which includes well data and any data added to the extent.
- **Drilling only.** The extent snaps to well data and data objects derived from well data within the **Maximum snap distance**, but not to other data used to modify the extent. For example, the extent will honour points data derived from well data, but not points data imported into the **Points** folder.
- **Custom.** The extent snaps to the data objects indicated in the **Inputs** tab that are within the **Maximum snap distance**.

Take care in enabling snapping and in selecting what data the surface will snap to, as the more data you include, e.g. by setting a large **Maximum snap distance** or selecting **All data** for **Snap to data**, the greater the possibility that errors in the data or assumptions inherent in interpretations (e.g. polylines) will cause distortions in the meshes. If you do enable snapping, it is best to snap only to drilling data. See [Honouring Surface Contacts](#) for more information on these settings.

The snap setting for the geological model will be used if **Snap to data** is set to **Inherit from GM**.

Whatever the setting, you can see what objects are snapped to by clicking on the **Inputs** tab.

If you need the extent to honour well data but treat other data objects as interpretations, select **Drilling only**. To honour some data objects while treating others as interpretations, select **Custom**, then click on the **Inputs** tab to enable snapping for individual objects.

Applying a Trend

You can adjust an extent created from polylines, GIS data, points and structural data by applying a trend to it. To do this, add the extent to the scene. Next, double-click on the extent in the project tree and click the **Trend** tab.

Often the easiest way to apply a trend is to click on the **Draw plane line** button  and draw a plane line in the scene in the direction in which you wish to adjust the surface. You may need to rotate the scene to see the plane properly.

The **Ellipsoid Ratios** determine the relative shape and strength of the ellipsoids in the scene, where:

- The **Maximum** value is the relative strength in the direction of the green line on the moving plane.
- The **Intermed.** value is the relative strength in the direction perpendicular to the green line

on the moving plane.

- The **Minimum** value is the relative strength in the direction orthogonal to the plane.

Once you have adjusted the plane to represent the trend you wish to use, click the **Set From Plane** button to copy the moving plane settings.

The **Set to** list contains a number of different options Leapfrog Geothermal has generated based on the data used in the project. **Isotropic** is the default option used when the extent was created. Settings made to other surfaces in the project will also be listed, which makes it easy to apply the same settings to many surfaces.

Click **OK** to apply the changes.

See [Global Trends](#) for more information.

Adding Data to an Extent

Extents created from polylines, GIS data, points and structural data can be modified by adding points data objects, GIS vector data and structural data. Extents created from a distance to points function can be modified by adding points data and GIS vector data. To add data to an extent, right-click on the extent in the project tree and select the data type you wish to use from the **Add** menu.

- Points data. Select from the points data objects available in the project and click **OK**.
- GIS vector data. Select from the GIS vector data available in the project and click **OK**.
- Structural data. Select from the structural data tables available in the project. If the selected table has query filters defined, you can apply one of these filters by selecting the required query from the list. Click **OK** to add the selected data to the extent. An alternative to adding an existing structural data table to an extent is to edit the extent with structural data. This is described in [Editing an Extent with Structural Data](#) below.

You can also add a polyline that already exists in the project. To do this, right-click on the extent in the project tree and select **Add > Polyline**. You will be prompted to choose from the polylines in the **Polylines** folder.

Editing an Extent with a Polyline

You can edit an extent using a polyline, which is described in [Editing Surfaces with Polylines](#). A polyline used to edit an extent will be added to the project tree as part of the extent. To edit the polyline, right-click on it and select **Edit Polyline** or add it to the scene and click the **Edit** button () in the shape list. If you wish to remove the polyline from the extent, right-click on it in the project tree and select **Delete** or **Remove**.

To add an existing polyline to a geological model extent, use the **Add > Polyline** option.

Editing an Extent with Structural Data

You can edit an extent using structural data, which is described in [Editing Surfaces with Structural Data](#). A structural data table will be added to the project tree as part of the extent. To edit the table, right-click on it and select **Edit In Scene** or add it to the scene and click the

Edit button (✎) in the shape list. If you wish to remove the table from the extent, right-click on it in the project tree and select **Delete** or **Remove**.

Removing an Extent from a Geological Model

If you have defined an extent and want to remove it from the model, there are two options. The first is to right-click on the extent in the project tree and click **Delete**. This deletes the extent from the model, but does not delete parent objects from the project unless they were created as part of the model, e.g. a polyline used as a lateral extent but not shared within the project. Use this option only if you are sure you do not want to use the extent.

The second method is useful if you are making changes to the extent and do not want to recompute the model with each change. Double-click on the model's **Boundary** object or double-click on the model and click on the **Boundary** tab. The **Boundaries** part of the window lists all objects used as extents for a geological model:

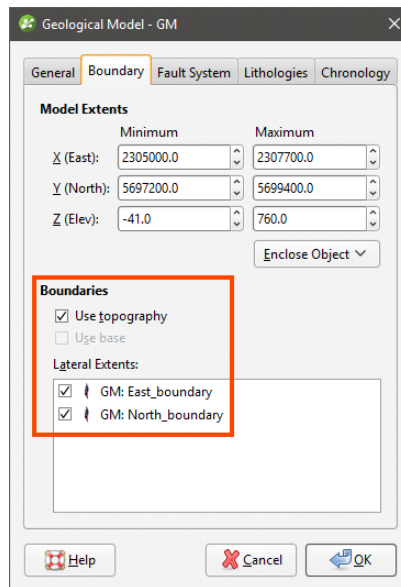

Untick the box for extents to temporarily disable them in the model. The model will be reprocessed, but you can then work on the extent without reprocessing the model. Disabled extents will be marked as inactive in the project tree:

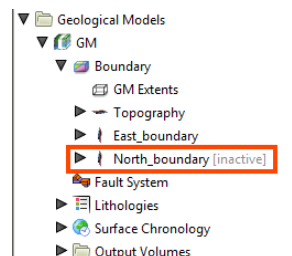

Model Lithologies

To view the lithologies used for a geological model, you can:

- Double-click on the geological model in the project tree and then click on the **Lithologies** tab.
- Double-click on the **Lithologies** object for the geological model in the project tree.

All the lithologies defined for the geological model are displayed, together with the colours used to display them:

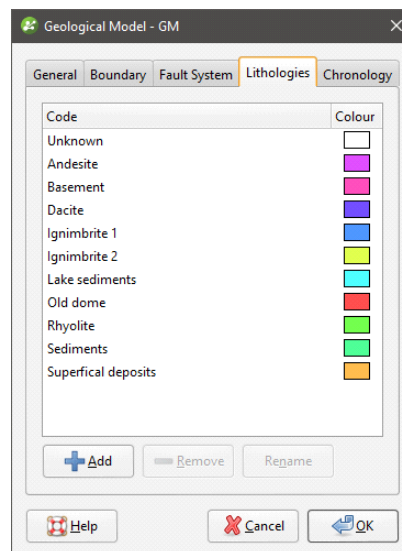

Click a colour chip to change the colours used to display the lithologies.

To set multiple lithologies to a single colour, use the Shift or Ctrl keys to select the colour chips you wish to change, then click on one of the colour chips. The colour changes you make will be made to all selected lithologies.

If the geological model was created from well data, the lithologies are automatically generated from that data. There is also an additional lithology, "Unknown", which is used to label lithologies that cannot be labelled using known lithologies. This is the case when a geological model is first created and no contact surfaces have been defined. The entire model volume has no identified lithologies and so is assigned as "Unknown".

An alternative to setting unidentified lithologies to "Unknown" is to select one of the defined lithologies as the "background lithology". To do this, double-click on the model's **Surface Chronology** and set **Background lithology** to one of the available lithologies. When you set the background lithology for a geological model and then enable the fault system, the background lithology will be copied to each fault block.

If there is no well data in the project or if the model is not based on well data, you will need to define the lithologies one-by-one. To do this, click on the **Add** button, enter a name for the lithology and choose a colour.

Faulted Models

This topic describes how to use the fault system to create and organise faults:

- [The Fault System](#)
- [Fault Interactions](#)
- [Activating the Fault System](#)
- [Copying the Surface Chronology to an Empty Fault Block](#)
- [Faulted Model Display Options](#)

Each geological model is created with a **Fault System** object that is used to construct faults. Once the faults are active in the geological model, the geological model will be divided into separate fault blocks, which will appear in the project tree as part of the model:

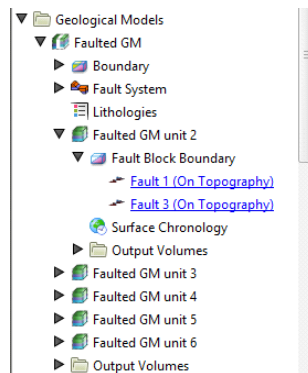

Each fault block has its own **Surface Chronology**, which can be modified without affecting other fault blocks in the geological model. There is no top-level **Surface Chronology** for the geological model once the **Fault System** has been activated. This means that lithology layers can be constructed for a faulted model in two ways:

- Define the **Surface Chronology** before enabling the **Fault System**. All surfaces defined for the unfaulted model will automatically be copied to each fault block. Some surfaces defined for the model as a whole will not occur in every fault block, which can be corrected by working with the surfaces in each fault block.
- Enable the **Fault System** before any surfaces are defined in the unfaulted model, then define the **Surface Chronology** for each fault block. An aid to working with a faulted model in this way is the ability to copy contact surfaces from one faulted block to another. See [Copying the Surface Chronology to an Empty Fault Block](#) below.

Which approach is best depends on the model being built. You may already know where the faults are and choose to define them and subdivide the geological model before defining any lithology layers. On the other hand, sometimes it is not apparent where the faults are until the layers have been built, in which case you can add the new fault, activate it in the model, then work with the surfaces in each fault block.

The Fault System

When a geological model is first created, the **Fault System** object is empty. To create faults, right-click on the **Fault System** object and select from the options available. Many of these options are similar to those for creating lateral extents. For more information, see:

- [Extent From a Polyline](#)
- [Extent From GIS Vector Data](#)
- [Extent From Points](#)
- [Extent From Structural Data](#)
- [Extent From a Surface](#)

Faults created from polylines and GIS vector data can be created as vertical walls or surfaces. Faults created as surfaces can be modified by adding further data, as described in [Editing Faults](#).

Creating a fault from the base lithology or other contacts is similar to creating contact surfaces. See [Deposits and Erosions From the Base Lithology](#) and [Deposits and Erosions From Other Lithology Contacts](#) for more information.

Faults will appear in the project tree as part of the **Fault System** object and can be expanded to show how they were created:

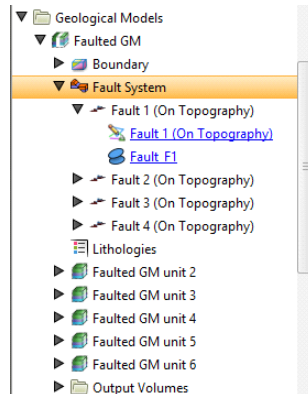

Once faults have been created, you can modify them as described in [Editing Faults](#).

Fault Interactions

Once all the faults required have been created, you can start defining the interactions between the faults by double-clicking on the **Fault System** object. The **Geological Model** will be opened with the **Fault System** tab displayed:

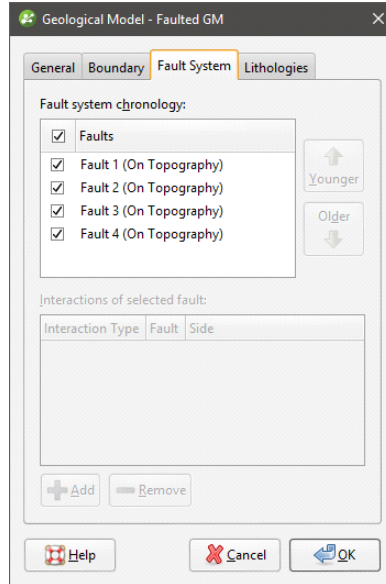

To add an interaction, click on a fault, then click the **Add** button. Select the **Interaction Type** and set how the faults interact:

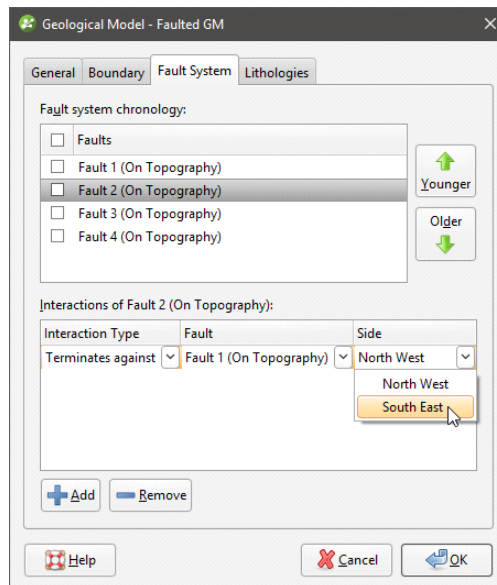

Once you have defined each fault interaction, click **OK** to generate the fault system. Add the **Fault System** object to the scene to check that the faults interact correctly.

You can also edit fault interactions by double-clicking on individual faults. The **Edit Fault** window will open, which shows only the interactions for the selected fault:

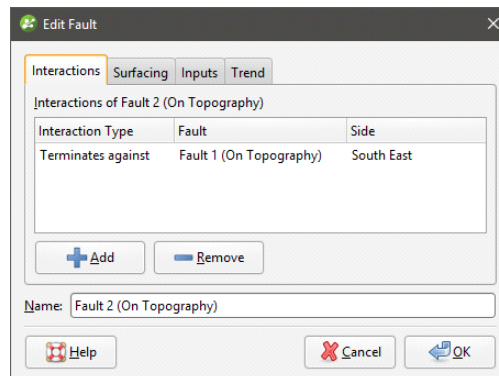

Faults are not active in the geological model until the box is ticked for each fault in the **Fault System** window, as described in [Editing Faults](#). This means you can check the fault system without regenerating the geological model.

Activating the Fault System

Activating the fault system divides the geological model into fault blocks, which can result in considerable processing time for complex models. It is important, therefore, to define fault interactions before enabling the fault system, otherwise a large number of fault blocks could be generated that significantly increase processing time. See [Fault Interactions](#) above.

To activate the fault system in the geological model, double-click on the **Fault System** object once again and tick the box for each fault. The model will be divided into separate fault blocks that can be worked with in a similar manner to the geological model as a whole.

Copying the Surface Chronology to an Empty Fault Block

If you are working with a faulted model and have defined the **Surface Chronology** for one fault block, you can copy the **Surface Chronology** to the empty fault blocks. To do this, right-click on the **Surface Chronology** for which you have defined surfaces and select **Copy Chronology To**. In the window that appears, select the fault blocks you want to copy contacts to and click **OK**. The surfaces will be copied and you can modify them without affecting the surfaces in the other fault blocks.

Faulted Model Display Options

Drag the model into the scene or right-click on it and select **View Object**; these options add the model to the shape list as a single object and you can change the visibility of each lithology by clicking the **Edit Colours** button. You can also add the model to the scene as a series of output volumes by right-clicking on the model and selecting **View Output Volumes**.

Another display option lets you view the individual fault blocks without displaying the lithology layers. Right-click on the model and select **View Fault Block Boundaries**.

To work with a specific fault block, click on it in the scene. The window that appears displays the name of the selected fault block:

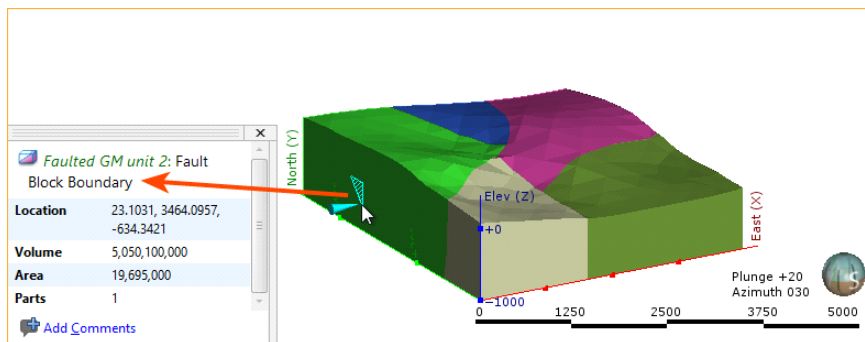

You can also view the output volumes for each individual fault block by right-clicking on the fault block in the project tree and selecting **View Output Volumes**.

Editing Faults

Once a fault has been defined, you can refine it in several ways:

- Add other data. This option is available for faults created as surfaces, but not for those created as vertical walls. Right-click on the surface to see the options available, which will depend on how the surface was created.
- Edit the surface with a polyline. Right-click on the surface in the project tree and select either **Edit > With Polyline**. See [Editing Surfaces with Polylines](#) for more information.
- Edit the surface using structural data. Right-click on the surface and select **Edit > With Structural Data**. See [Editing Surfaces with Structural Data](#) for more information.

The rest of this topic describes other options for editing faults. It is divided into:

- [Surfacing Options for Faults](#)
- [Changing Fault Inputs](#)
- [Applying a Trend to a Fault](#)

Surfacing Options for Faults

To change surfacing options for a fault, double-click on the fault in the project tree, then click on the **Surfacing** tab.

See [Surface Resolution for a Geological Model](#) and [Honouring Surface Contacts](#) for information about the settings in the **Surfacing** tab.

The settings in the **Surfacing** tab will be disabled if the fault inputs have been replaced with a mesh.

Boundary Filtering

When data objects are added to a fault, there are two ways to handle the data that lies outside the fault boundary:

- Filter the data. The fault is only influenced by the data that falls inside the fault boundary.
- Leave the data unfiltered. The fault is influenced by the data both inside and outside the fault boundary.

The **Boundary filter** setting determines how data used to define the fault is filtered:

- **Off**. Data is not filtered.
- **All data**. All data is filtered.
- **Drilling only**. Only well data and data objects derived from well data are filtered.
- **Custom**. Only the data objects specified in the **Inputs** tab are filtered.

Snapping to Data

There is a **Snap to data** setting for a geological model as a whole that is set in the **Geological Model > General** tab (see [Editing a Geological Model](#)). **Snap to data** can also be set on a surface-by-surface basis by double-clicking on the surface in the project tree and then clicking on the **Surfacing** tab.

For faults, the options are:

- **Inherit from GM**. The setting for the geological model as a whole is used. This is the default setting.
- **Off**. The fault surface does not snap to the data used to create it.
- **All data**. The fault surface snaps to all data within the **Maximum snap distance**, which includes well data and any data added to the fault.
- **Drilling only**. The fault surface snaps to well data and data objects derived from well data within the **Maximum snap distance** but not to other data used to modify the fault. For example, the fault surface will honour points data derived from well data, but not points data imported into the **Points** folder.
- **Custom**. The fault surface snaps to the data objects indicated in the **Inputs** tab.

Take care in enabling snapping and in selecting what data the surface will snap to, as the more data you include, e.g. by setting a large **Maximum snap distance** or selecting **All data** for **Snap to data**, the greater the possibility that errors in the data or assumptions inherent in interpretations (e.g. polylines) will cause distortions in the meshes. If you do enable snapping, it is best to snap only to drilling data. See [Honouring Surface Contacts](#) for more information

on these settings.

If you need the fault surface to honour well data but treat other data objects as interpretations, select **Drilling only**. To honour some data objects while treating others as interpretations, select **Custom**, then click on the **Inputs** tab to enable snapping for individual objects.

Changing Fault Inputs

For faults, the **Inputs** tab shows all the data objects used to create the fault and whether the **Snap** and **Boundary filter** options are enabled for each object used to define the fault. If an input has any query filters defined, you can select one in this window.

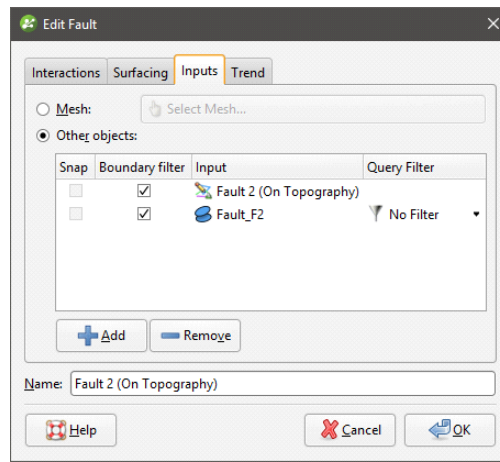

You can also replace the fault's inputs with a single mesh or add more data to the fault.

Replacing Fault Inputs with a Single Mesh

To replace the fault inputs with a single mesh, click on the **Mesh** option, then select from the meshes available in the project.

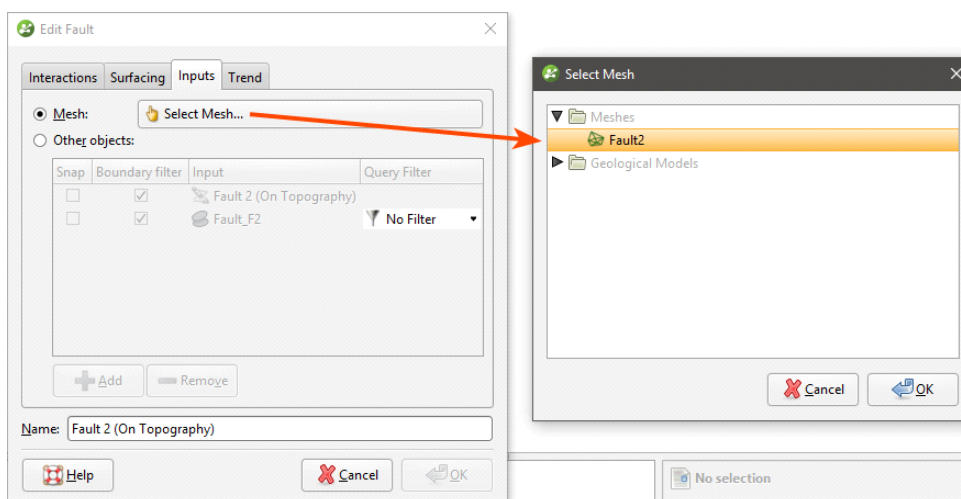

When you select a single mesh to define the fault, all other inputs listed in the **Inputs** tab will be removed from the fault. This can result in objects being deleted from the project. For

example, if the fault has been edited using a polyline, the polyline will be deleted when the inputs are replaced with the mesh. If you wish to retain such inputs, be sure to share the object before changing the inputs. See [Sharing Objects](#) for more information.

The snap and boundary filtering controls in the **Surfacing** tab will be disabled as the settings from the geological model will be used. The settings in the **Trend** tab will also be disabled as it is not possible to set a trend for a fault defined from a mesh.

Adding Data to the Fault

To add more data to the fault, click on the **Select Objects** button, then select from the suitable objects available in the project.

Snap Settings for Individual Inputs

The **Snap** setting determines whether or not the faults surface honours a particular data object. Often, surfaces should honour well data and treat data objects such as polylines and GIS data as interpretations, as discussed in [Honouring Surface Contacts](#). To change snap settings for a fault, click on the **Surfacing** tab and set **Snap to data** to **Custom**. You will then be able to change **Snap** settings in the **Inputs** tab.

Boundary Filtering Settings for Individual Inputs

When data objects are added to a fault, there are two ways to handle the data that lies outside the fault boundary:

- Filter the data. The fault is only influenced by the data that falls inside the fault boundary.
- Leave the data unfiltered. The fault is influenced by the data both inside and outside the fault boundary.

To change the **Boundary filter** settings for each object used to define a fault, click on the **Surfacing** tab and set **Boundary filter** to **Custom**. You will then be able to change **Boundary filter** settings in the **Inputs** tab.

Applying a Trend to a Fault

To apply a trend to a fault, either:

- Double-click on the fault in the project tree, then click on the **Trend** tab.
- Right-click on the fault in the project tree and select **Adjust Surface**. This opens the **Edit Fault** window with the **Trend** tab displayed.

See [Global Trends](#) for information on using the controls in this tab.

The settings in the **Trend** tab will be disabled if the fault inputs have been replaced with a mesh.

Contact Surfaces

Defining the internal structure of a geological model involves generating contact surfaces that correspond to the boundaries between lithological units, refining the contact surfaces, arranging them in chronological order and then using the surfaces and the chronological order to divide the geological model into units. The **Surface Chronology** object represents the collection of contact surfaces and defines how they interact to produce the volumes of the geological model. Factors that influence the interaction of contact surfaces with the volumes of the geological model are:

- The order of the contact surfaces in the **Surface Chronology**. See [Contact Surfaces in the Surface Chronology](#).
- The type of contact surface. See [Contact Surfaces Types](#) for more information.
- The orientation of the older and younger sides of the surface. See [Younging Direction](#).

The remainder of this topic describes how the different types of contact surface interact and will help you in deciding how to model different units. For specific information on creating the different types of contact surfaces, see:

- [Deposits and Erosions](#)
- [Intrusions](#)
- [Veins](#)
- [Vein Systems](#)
- [Stratigraphic Sequences](#)

Contact Surfaces in the Surface Chronology

When a geological model is first created, it is simply a volume that is assigned the background lithology. This background lithology is initially "Unknown", as although the model has lithologies defined, Leapfrog Geothermal cannot determine what lithology to use for the background lithology.

The contact surfaces and their order in the **Surface Chronology** determine how they divide this larger "Unknown" volume into known lithological units. The scene below shows the **Surface Chronology** for four deposit contact surfaces and two intrusion contact surfaces, bounded by the geological model extents (pink). The two intrusion contacts are labelled as Unknown on the outside and the intrusion lithology on the inside:

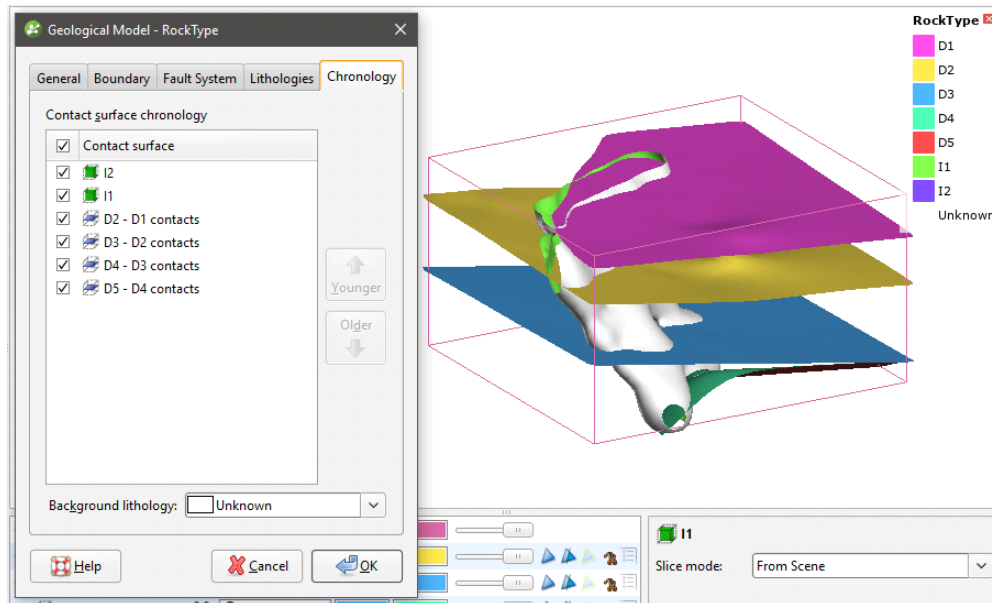

The **Surface Chronology** is open, showing the contact surfaces in chronological order, with the youngest at the top of the list. This is the order in which contact surfaces will be used to cut the "Unknown" volume of a newly created model. The different types of contact surfaces cut older volumes in different ways, which are described below in [Contact Surface Types](#).

For the model shown above, the first contact surface to cut the geological model volume is the oldest surface, D5 - D4 contacts. The volume is divided into D5 (red) below and D4 (green) above:

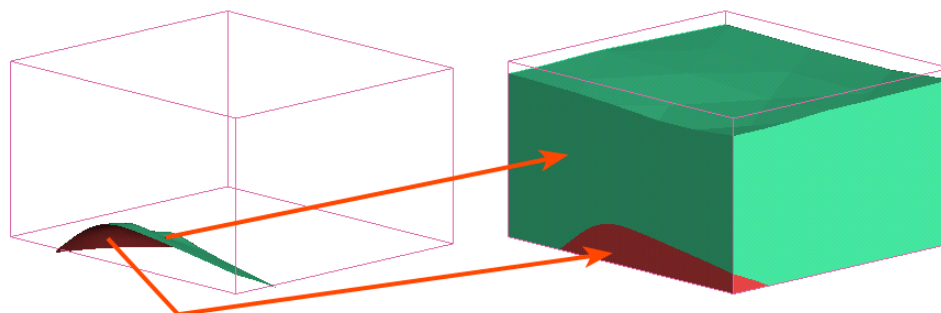

When the next contact surface (D4 - D3 contacts) is enabled in the model, the volume above the contact surface is labelled with the lithology assigned to the surface's younger side (blue):

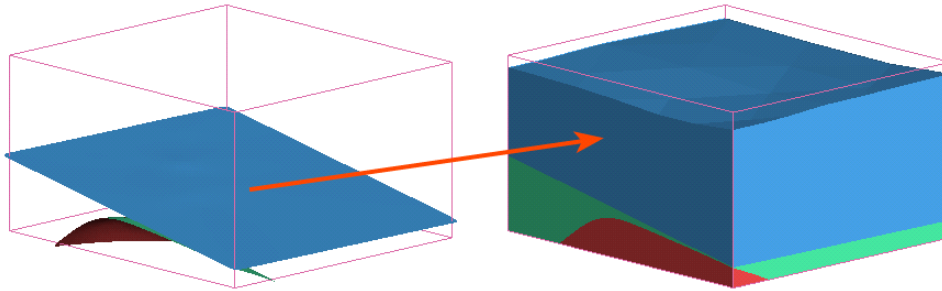

Therefore, any volume in a geological model is labelled with the lithology assigned to the youngest side of the surface that last cut the volume.

With a simple deposit geological model, as long as each side of each contact surface is assigned a lithology, all volumes will be labelled with known lithologies. Intrusive contact surfaces, however, are often of unknown lithology on the outside, as they contact multiple lithologies. When the two intrusive surfaces in the model above are enabled but all deposit surfaces are disabled, the unknown lithology is replaced with each intrusive lithology on the inner sides of each contact surface, but outside each intrusive contact surface the lithology is not known:

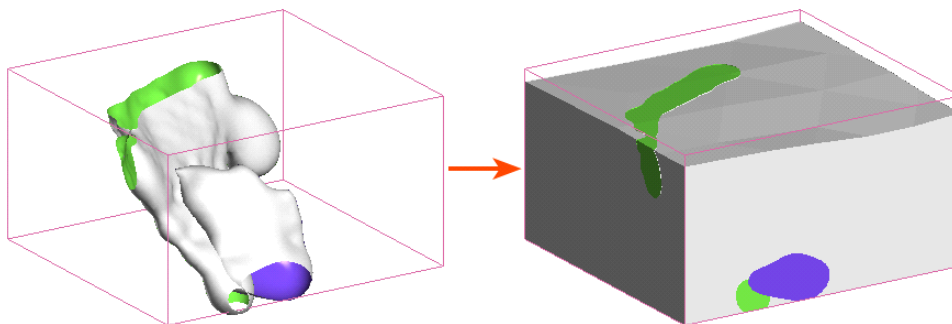

If the outside of the older contact surface (green) is assigned a lithology (red), the volume outside each intrusion is known and, therefore, the surrounding volume can be labelled:

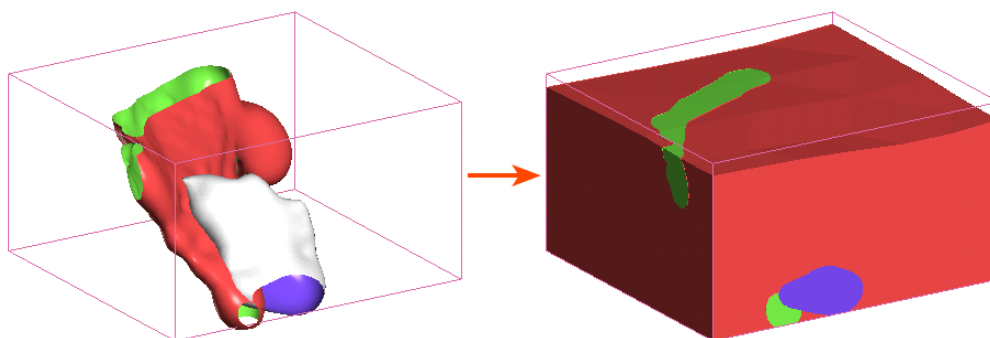

If, however, the outside of the younger intrusion is known but the outside of the older intrusion is unknown, it is not possible to determine the lithology of the surrounding volume as the lithology on the outer side of the surface making the first cut is not known:

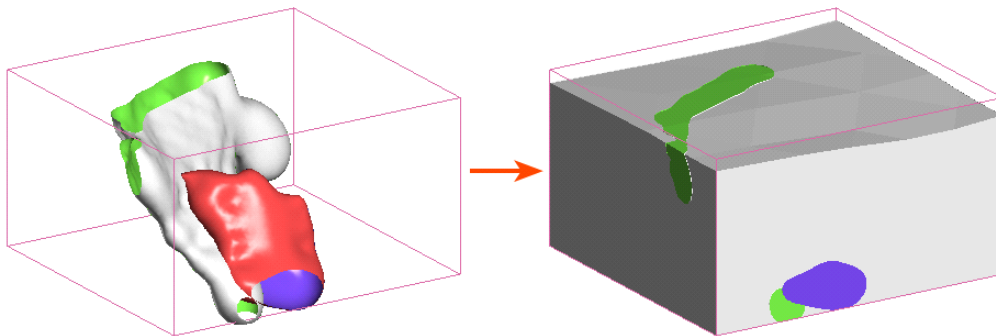

Contact Surfaces Types

The different types of contact surfaces result in different shapes and cut older volumes in different ways. The contact surface types are:

- **Deposit.** Deposit contact surfaces tend to be sheet-like, with the primary lithology on the young side and the contacting/avoided lithologies on the older side. Deposits do not cut older volumes. A volume defined by a deposit contact surface will, therefore, appear conformably on top of older volumes.
- **Erosion.** Erosion contact surfaces are similar to deposits, but cut away other contact surfaces on the older side of the erosion contact surface.
- **Intrusion.** Intrusion contact surfaces are rounder in shape, with an interior lithology that represents the intrusion lithology. The intrusion removes existing lithologies and replaces them with the intrusive lithology on the younger side of the contact surface. Often, the older side of an intrusion contact surface is labelled "Unknown" as typically intrusions displace multiple older lithologies.
- **Vein.** Vein contact surfaces remove existing lithologies and replace them with the vein lithology within the boundaries defined by hangingwall and footwall surfaces and points and a reference surface.

These terms are indicative of the resulting shape and cutting behaviour of a surface rather than of the geological formations that can be modelled. In fact, it might make sense to model something like basement granite as a deposit rather than as an intrusion when it forms the lowest layer in the geological model. If there are no older layers for an intrusion-type contact surface to remove and it is apparent from the well data that the lithology simply fills the lowermost parts of the model, then it makes sense to model it as a deposit.

An important consideration in building contact surfaces is that they have an older side and a younger side. This is described in more detail in [Younging Direction](#) below, but it is sufficient to understand, at this point, that younging direction is one factor in determining how the different types of contact surfaces cut older surfaces.

Deposit and Erosion Contact Surfaces

Deposits and **erosions** are both roughly flat surfaces. The difference between the two is that deposits appear conformably on top of underlying older volumes and do not occur in regions defined by older deposits, while erosions remove existing lithologies on the older side of the erosion. This difference is illustrated here, using a model made up of three deposits, A, B and C:

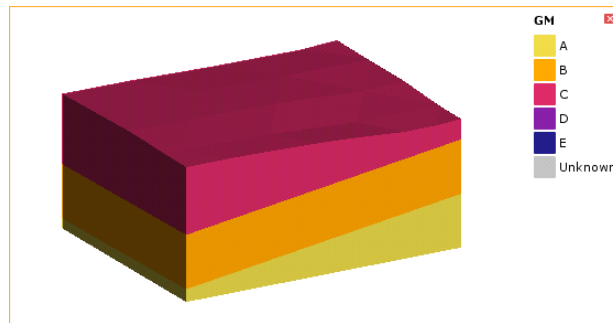

The contact surfaces that define the three output volumes are the B-C contacts surface (pink) toward the top of the model extents and the A-B contacts surface (gold) lower down:

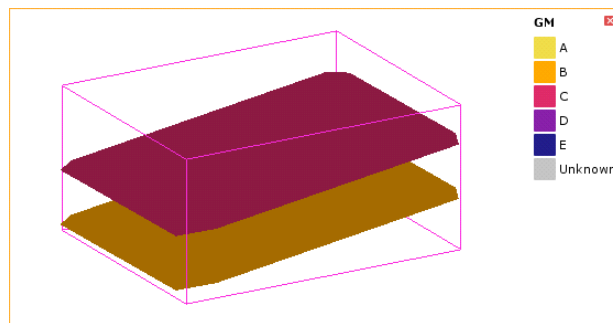

An erosion contact surface (C-D contacts) added to the model cuts across the A-B and B-C contacts. The younger (purple) side of the C-D contact surface faces up:

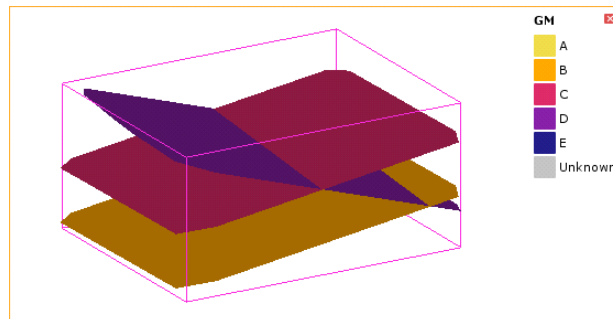

Once the model is recalculated, the erosion (D) has cut away the deposits on the older side of the erosion:

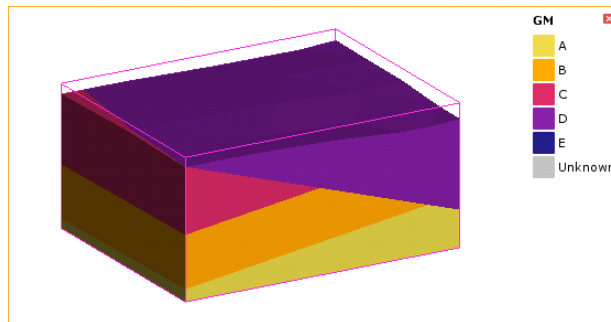

However, if the C-D contact surface is changed to be a deposit surface, D only occurs on the younger side of the C-D contact surface and does not cut away the A, B and C volumes:

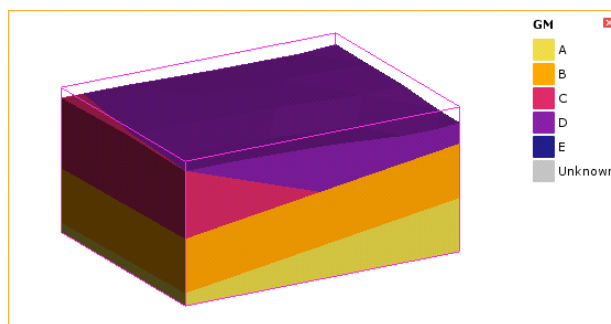

See [Deposits and Erosions](#) for information on techniques for creating deposits and erosions.

Intrusion Contact Surfaces

An **intrusion** is a type of contact surface that removes existing lithologies and replaces them with the intrusive lithology. Intrusions are rounder in shape than deposits and erosions, with an interior lithology that represents the intrusion lithology on the inside of the shape.

Adding an intrusion (E) surface added to the example model above as the youngest surface cuts away the other lithologies on the inside of the surface:

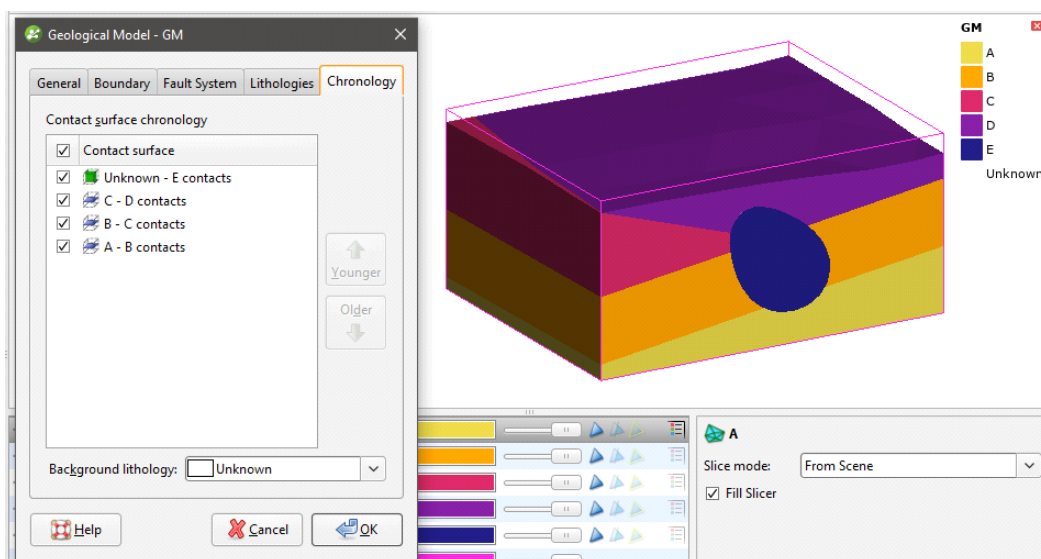

Note that the intrusion contacts multiple units. This is typical of intrusion contact surfaces as an intrusion will usually displace multiple older lithologies. Although the outside of the intrusion is not labelled with a lithology, the lithology of each volume the intrusion comes into contact with can be known from the lithologies assigned to the deposit contact surfaces.

However, when all contact surfaces are intrusions, the lithology of the surrounding volume cannot be known, which results in intrusion volumes surrounded by an Unknown volume:

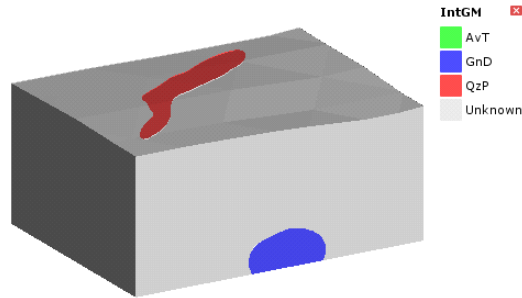

In this instance, the contact surfaces each have a known side and an unknown side:

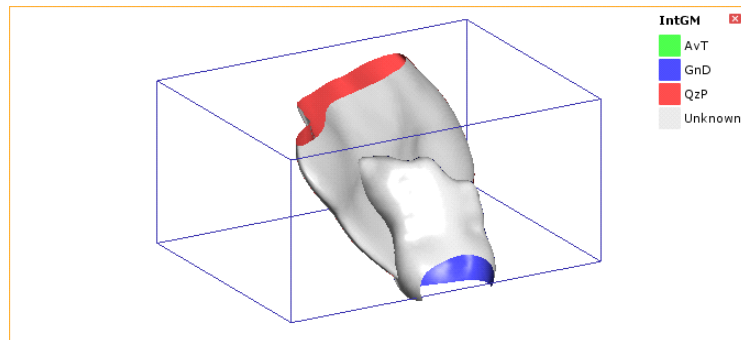

Adding the wells to the scene helps in understanding what lithology the outside of each intrusion should be:

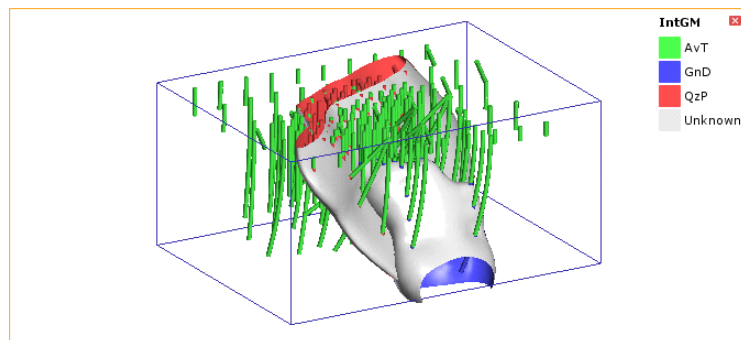

In this case, opening the **Surface Chronology** and assigning AvT as the background lithology results in a model for which all volumes are labelled with a known lithology:

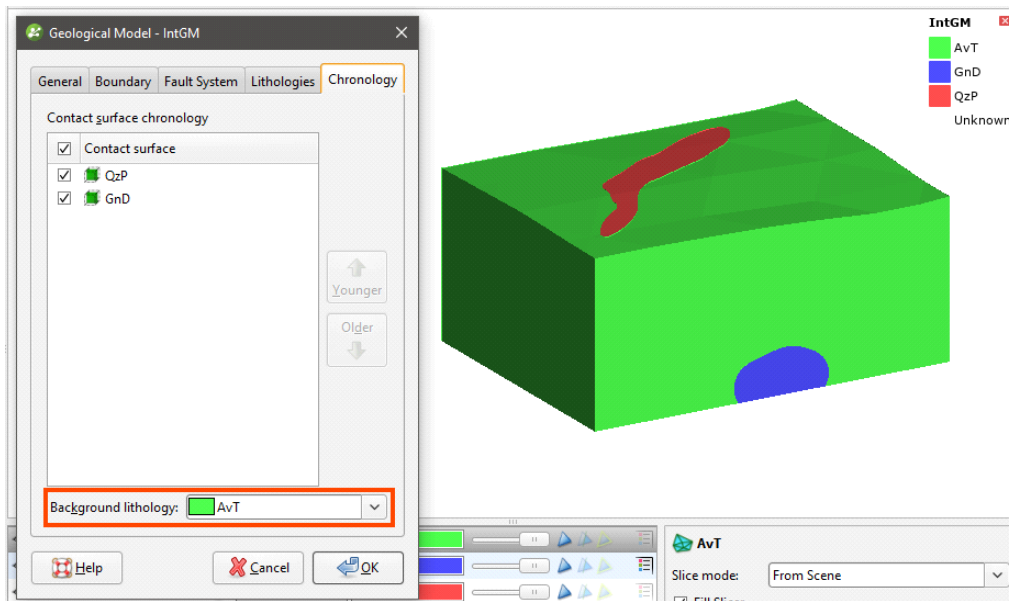

See [Intrusions](#) for information on techniques for creating intrusions.

Vein Contact Surfaces

Veins remove existing lithologies and replace them with the vein lithology within the boundaries defined by hangingwall and footwall surfaces and points and a reference surface. Here, a slice has been made horizontally through a model made up of three deposits:

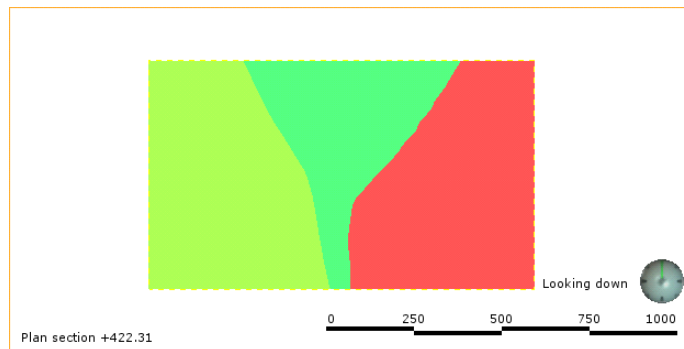

Adding five dykes modelled as veins and enabling them in the model results in the veins cutting away each deposit at the point of contact:

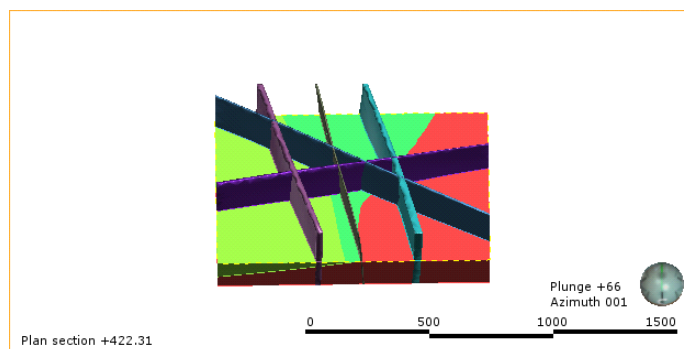

Here the sliced deposits are displayed but the veins are hidden in order to show how they cut away the deposits:

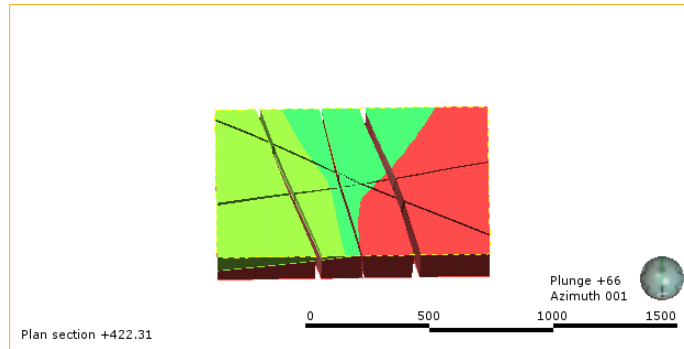

See [Veins](#) for information on techniques for creating veins.

Younging Direction

An important factor in determining how surfaces interact is the younging direction of each surface. Each contact surface has a younger side and an older side. For deposit and erosion contact surfaces, Leapfrog Geothermal will, by default, put the younger side up, since this is geologically reasonable in most situations. If, for example, you know that the geology is overturned, you can change the younging direction once the surface has been created.

For intrusion contact surfaces, the younger side of the surface is the inside, although this can be swapped if Leapfrog Geothermal has assigned it incorrectly, as may be the case with flatter intrusion surfaces.

When contact surfaces are displayed in the scene, you can choose whether to display the surfaces using the lithology or the younging direction. When the younging direction is displayed, the younger side is typically green and the older side is brown:

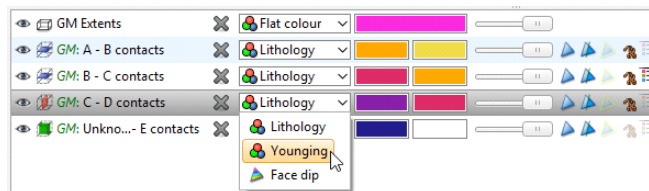

When a contact surface is displayed using the younging direction, Leapfrog Geothermal by default colours the younger side green and the older side brown.

Deposits and Erosions

This topic describes creating and editing deposits and erosions. The topic is divided into:

- [Creating Deposits and Erosions](#)
- [Deposits/Erosions in the Project Tree](#)
- [Refining Deposits and Erosions](#)
- [Surfacing Options for Deposits and Erosions](#)

For a general introduction to how deposits and erosions interact with other contact surfaces, see [Deposit and Erosion Contact Surfaces](#) in [Contact Surfaces](#).

Creating Deposits and Erosions

Lithology data is often the most reliable data source to use when building geological surfaces, and it is best to derive contact surfaces from lithology data when it is available. If no lithology data is available, you can create deposits and erosions from other data in the project. You can also create offset surfaces from other surfaces in the project, which is useful for creating a series of surfaces. See [Offset Surfaces](#) for more information.

Deposits and Erosions From the Base Lithology

It is best to derive contact surfaces from lithology data, when it is available. There are two ways to create contact surfaces from lithology data:

- Using the base lithology column assigned when the model was created. This is the process described below.
- Using other lithology information available in the project. This is useful when you have created an additional lithology column as part of correcting and working with the well data. For example, if when building a geological model it becomes apparent that changes need to be made to the well data, you can import additional data or create a new column using the split lithology, group lithology or interval selection tools. See [Deposits and Erosions From Other Lithology Contacts](#) for more information.

Selecting the **From Base Lithology** option opens the **New Contact Points** window:

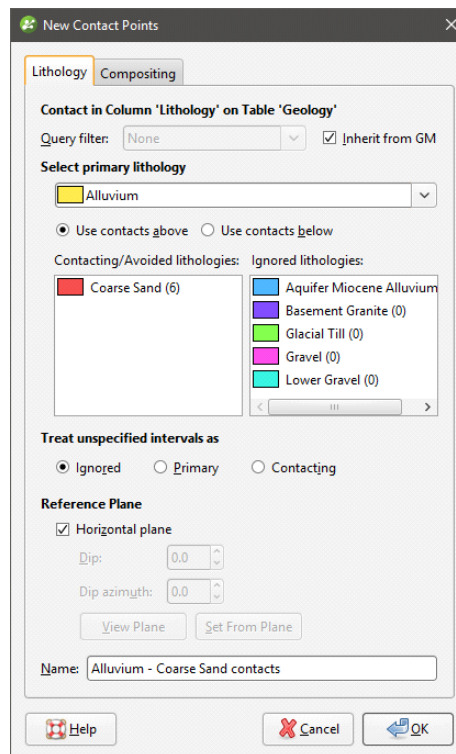

Select the lithology you wish to use to create the surface from the **Select primary lithology** list; this will be the older lithology (lower down) in the geological model. The **Contacting/Avoided**

lithologies list shows the lithologies that contact the primary lithology and the number of contacts. This helps in selecting which contacts to use to create the contact surface.

The options in the **Lithology** tab are useful for creating a surface when one lithology is interbedded with another. For example, here we can see that the coarse sand is interbedded with alluvium:

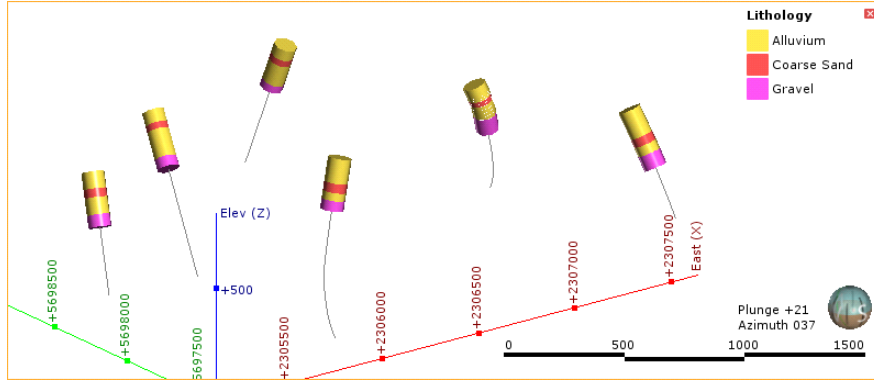

The solution to this is to create two surfaces from the Alluvium contacts, one using the contacts above (younger contacts) and the other using the contacts below (older contacts):

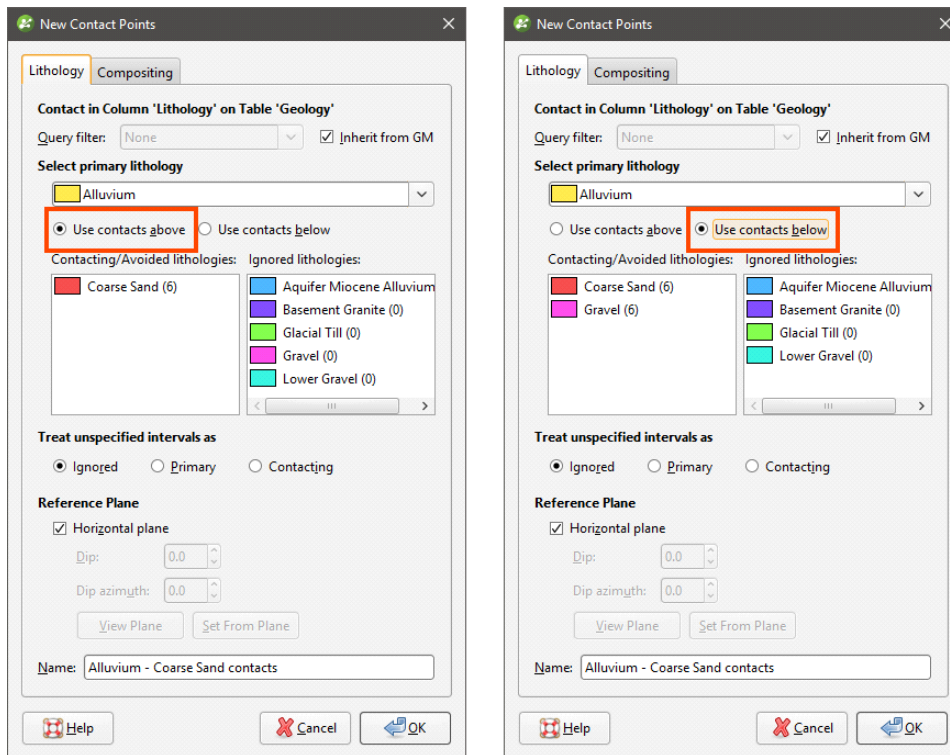

Note that the gravel contacts should be excluded for the surface created from the **Use contacts below** option, as we can see from the well data that gravel appears lower down in the model than the surface we are creating. Do this by dragging the contacts that should be excluded to the **Ignored lithologies** list:

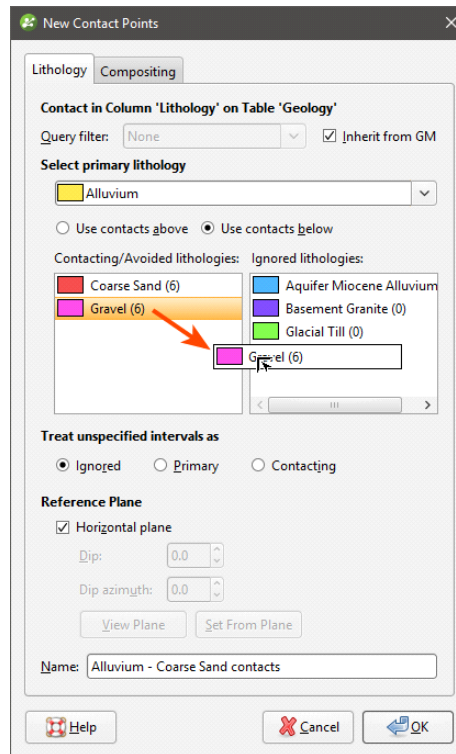

Unspecified intervals are intervals that have no data. By default, unspecified intervals are ignored when creating a contact surface, but you can also treat them as the primary lithology or as avoided lithologies.

For complex geologies, the up and down directions for the surface may not be clear. If this is the case, untick the **Horizontal Plane** box. A reference plane will appear in the scene, with the up-facing surface labelled A and the downward-facing surface labelled B:

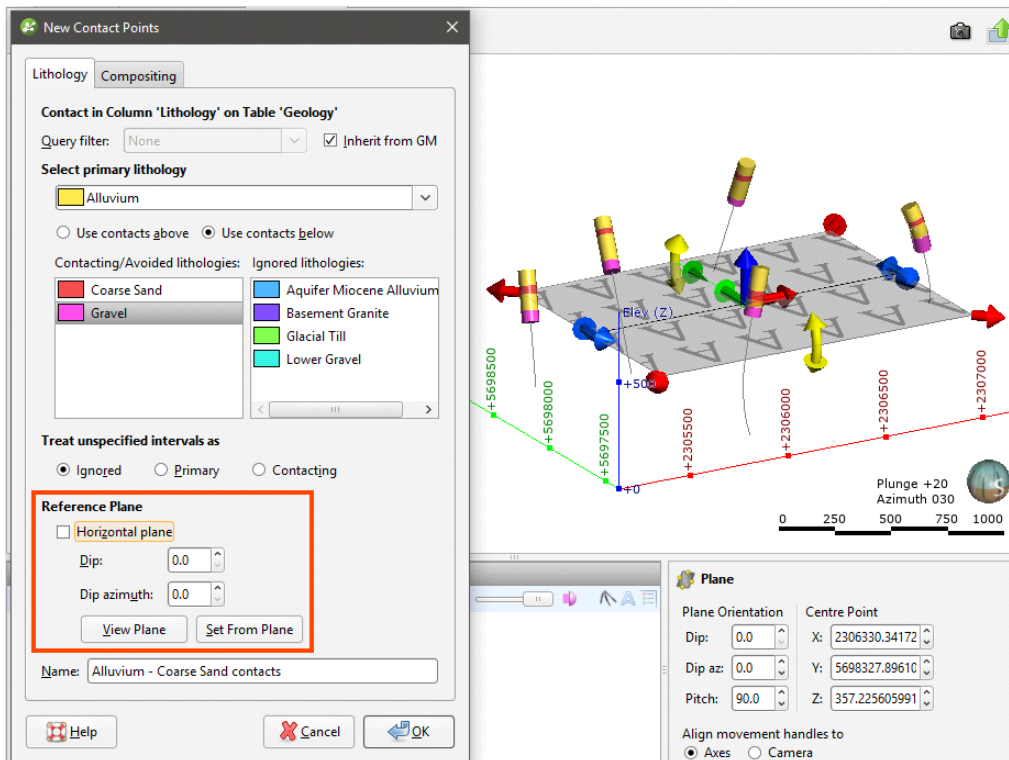

Controlling the position of the reference plane is similar to controlling the position of the moving plane:

- Use the handles in the scene window to move the plane.
- Set the **Dip** and **Dip Azimuth** values in the **New Contact Points** window. The reference plane will be updated in the scene.

Once the reference plane is correctly oriented, click the **Set From Plane** button.

Setting a reference plane for contact points is different from applying a global trend to a surface. To apply a global trend to a surface, double-click on the surface in the project tree and click on the **Trend** tab. See [Global Trends](#).

Data can be composited at the well level or on a surface-by-surface basis. To composite the data used to generate the contact surface, click on the **Compositing** tab. See [Category Composites](#) for more information.

Click **OK** to create the contact surface, which will appear in the project tree under the **Surface Chronology**. See [Refining Deposits and Erosions](#) below for more information on refining the contact surface.

Deposits and Erosions From Other Lithology Contacts

Creating deposit and erosion contact surfaces using the **From Other Contacts** option is useful when you have created an additional lithology column as part of correcting and working with the well data. For example, if when building a geological model it becomes apparent that

changes need to be made to the well data, you can import additional data or create a new column using the split lithology, group lithology or interval selection tools. See [Splitting Lithologies](#), [Grouping Lithologies](#) and [Interval Selection](#) for more information.

The process is similar to creating a surface from the base lithology column, but you must first select the lithology column you will use:

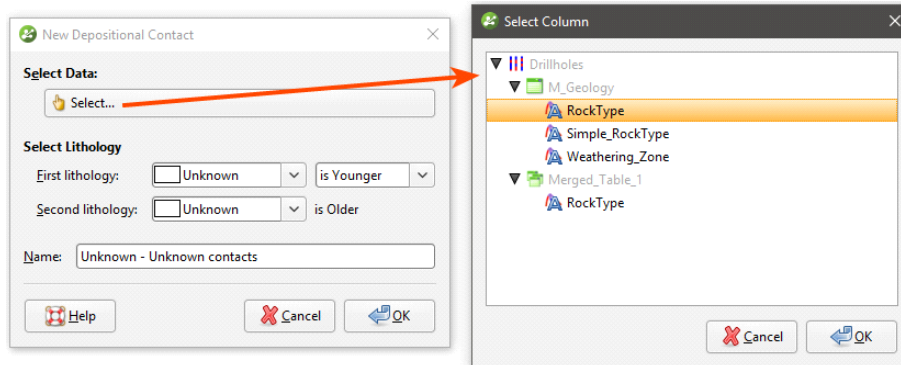

Select the **First Lithology** and **Second Lithology**, if known. Click **OK**. The **New Contact Points** window will appear. Assign the **Primary lithology**, **Contacting/Avoided lithologies** and the **Ignored lithologies**. These can only be selected from the model's base lithology.

The rest of the process is similar to defining a contact surface from the base lithology. See [Deposits and Erosions From the Base Lithology](#) above for more information.

Be sure to add the contact surface to the scene to view it and check that it is oriented correctly.

See [Refining Deposits and Erosions](#) below for more information on the different techniques that can be used for adjusting a contact surface.

Deposits and Erosions From Other Data

If suitable lithology data is not available, deposits and erosions can be created from other data in the project, such as GIS data, structural data, points, polylines and surfaces. The steps for creating deposits and erosions from other data are similar, regardless of the data used to create the surface:

- Right-click on the **Surface Chronology** and select one of the data types from the **New Deposit/Erosion** menu.
- Select the data object that will be used to define the surface. This must already be in the project, unless you are using a polyline, in which case you are given the option to create a new polyline.
- Select the **First lithology** and **Second lithology**. These are the lithologies that will be assigned to each side of the contact surface. The lithologies you can choose from are those defined for the geological model in the **Lithologies** object (see [Model Lithologies](#)).
- Set whether the **First lithology** is older or younger than the **Second lithology**. Leapfrog Geothermal will, by default, put the younger side of a contact surface up, but this can be changed later.

Here, a points data object is being used to create a deposit:

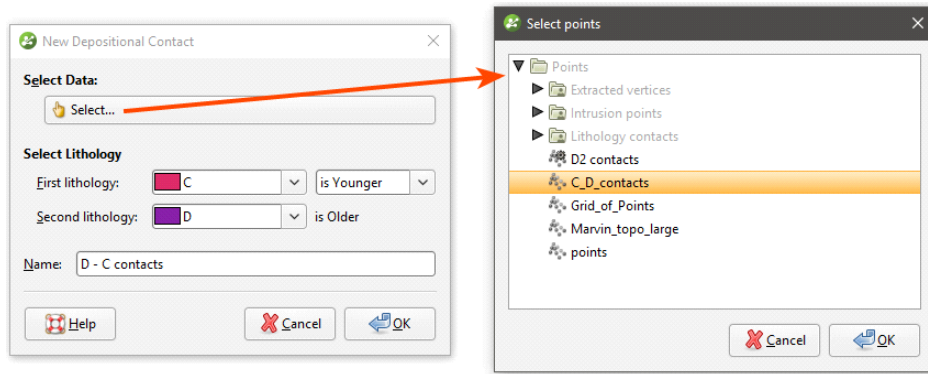

For polylines, you first set the lithologies and the younging order:

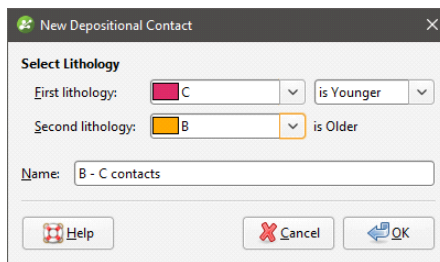

Click **OK** to move on to the next step:

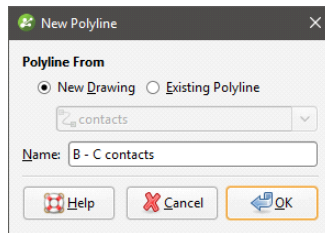

You can draw the polyline in the scene directly by selecting the **New Drawing** option. You can also use any polyline in the project by selecting the **Existing Polyline** option. You can then select the required polyline from the list.

The new contact surface will appear in the project tree under the **Surface Chronology**. Add the contact surface to the scene to view it and check that it is oriented correctly.

Expand the surface in the project tree to see how it was made. Here, a number of surfaces have been created using different types of data:

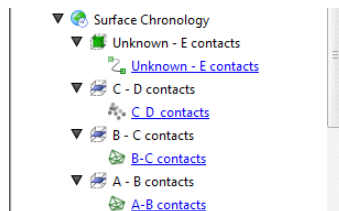

If creating a surface from a new polyline, the polyline will not be able to be used elsewhere in the project unless it has been shared. To share the polyline, expand the contact surface in the project tree, right-click on the polyline and select **Share**. The polyline will then be available elsewhere in the project.

As further refinements are made to the surface, that information will also be added to the contact surface in the project tree.

Deposits/Erosions in the Project Tree

The name Leapfrog Geothermal automatically assigns to a deposit or an erosion is the lithologies assigned to each side of the surface. In the project tree, expand the surface to see how it was made:

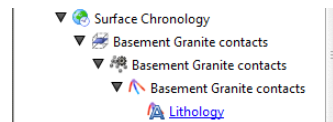

Double-click on the surface to edit it. Double-click on the contact points object (🌿) to edit the lithology and change compositing parameters.

As further refinements are made to the surface, that information will also be added to the project tree. See [Refining Deposits and Erosions](#) below for more information.

Refining Deposits and Erosions

You can refine deposits and erosions in several ways:

- Add other data. Right-click on the surface to see the options available, which will depend on how the surface was created. See [Adding Data to Surfaces](#) for more information.
- Edit the surface with a polyline. Right-click on the surface in the project tree and select either **Edit > With Polyline**. See [Editing Surfaces with Polylines](#) for more information.
- Edit the surface using structural data. Right-click on the surface and select **Edit > With Structural Data**. This option is available for deposits and erosions created from lithology data and other data in the project, but not for offset surfaces. See [Editing Surfaces with Structural Data](#) for more information.

To edit the surface's settings, double-click on it in the project tree. In the **Lithologies** tab, change the lithologies assigned to each side of the surface, if required.

You can swap the younging direction if the direction was assigned incorrectly when the surface was created. The change will be reflected in the scene. Note that changing the younging direction does not change which lithology is older or younger.

The difference between deposit and erosion contact surfaces is how they cut older lithologies, as described in [Contact Surfaces](#). For this reason, it is possible to change between the two types using the **Contact Type** setting.

For information on other techniques for refining deposits and erosions, see:

- [Surfacing Options for Deposits and Erosions](#)
- [Offset Surfaces](#)

Surfacing Options for Deposits and Erosions

Surfacing options for deposits and erosions can be changed by double-clicking on the surface in the project tree and then clicking on the **Surfacing** tab. There are additional settings related to boundary filtering and snapping to data in the **Inputs** tab.

Boundary Filtering

When data objects are added to a surface, there are two ways to handle the data that lies outside the surface's boundary:

- **Filter the data.** The surface is only influenced by the data that falls inside the surface's boundary.
- **Leave the data unfiltered.** The surface is influenced by the data both inside and outside the surface's boundary.

The **Boundary filter** setting determines how data used to define the surface is filtered:

- **Off.** Data is not filtered.
- **All data.** All data is filtered.
- **Drilling only.** Only well data and data objects derived from well data are filtered.
- **Custom.** Only the data objects specified in the **Inputs** tab are filtered.

Snapping to Data

Often, surfaces should honour well data and treat data objects such as polylines and GIS data as interpretations. See [Honouring Surface Contacts](#).

There is a **Snap to data** setting for a geological model as a whole that is set in the **Geological Model > General** tab (see [Editing a Geological Model](#)). **Snap to data** can also be set on a surface-by-surface basis by double-clicking on the surface in the project tree and then clicking on the **Surfacing** tab.

For individual contact surfaces, the options are:

- **Inherit from GM.** The setting for the geological model as a whole is used. This is the default setting.
- **Off.** Surfaces do not snap to the data used to create them.
- **All data.** Surfaces snap to all data within the **Maximum snap distance**, which includes well data and any data added to the surfaces.
- **Drilling only.** Surfaces snap to well data and data objects derived from well data within the **Maximum snap distance** but not to other data used to modify the surfaces.
- **Custom.** Surfaces snap to the data objects indicated in the **Inputs** tab for each surface.

Take care in enabling snapping and in selecting what data the surface will snap to, as the more data you include, e.g. by setting a large **Maximum snap distance** or selecting **All data** for **Snap to data**, the greater the possibility that errors in the data or assumptions inherent in

interpretations (e.g. polylines) will cause distortions in the meshes. If you do enable snapping, it is best to snap only to drilling data. See [Honouring Surface Contacts](#) for more information on these settings.

If you need a surface to honour well data but treat other data objects as interpretations, select **Drilling only**. To honour some data objects while treating others as interpretations, select **Custom**, then click on the **Inputs** tab to enable snapping for individual objects.

Setting the Surface Resolution

See [Surface Resolution for a Geological Model](#) for information about the surface resolution settings in the **Surfacing** tab.

Applying a Trend to a Deposit/Erosion

There are two ways to change the trend for a deposit or an erosion:

- Right-click on the surface in the project tree and select **Adjust Surface**.
- Double-click on the surface in the project tree and then click on the **Trend** tab.

See [Global Trends](#) for more information.

Intrusions

This topic describes creating and editing intrusions. The topic is divided into:

- [Creating Intrusions](#)
- [Intrusions in the Project Tree](#)
- [Displaying Intrusion Points](#)
- [Refining Intrusions](#)
- [Surfacing Options for Intrusions](#)
- [Applying a Trend to an Intrusion](#)
- [Clipping Values for Intrusions](#)
- [Interpolation Settings](#)

For a general introduction to how intrusions interact with other contact surfaces, see [Intrusion Contact Surfaces](#) in [Contact Surfaces](#).

Creating Intrusions

Lithology data is often the most reliable data source to use when building geological surfaces, and it is best to derive contact surfaces from lithology data when it is available. If no lithology data is available, you can create intrusions from other data in the project.

One thing to keep in mind for all intrusion contact surfaces is that an intrusion removes all the existing material on the younger side of the contact surface. Therefore:

- An intrusion should always have the younger side of its surface labelled with the intruded material. This is called the “interior lithology”.
- The older side will typically be labelled “Unknown” as an intrusion will usually displace multiple older lithologies. This is called the “exterior lithology”.

Intrusions from Lithology Contacts

Lithology data is often the most reliable data source to use when building geological surfaces, and it is best to derive contact surfaces from lithology data when it is available. There are two ways to create intrusions from lithology data:

- Using the base lithology column assigned when the model was created.
- Using other lithology information available in the project. This is useful when you have created an additional lithology column as part of correcting and working with the well data. For example, if when building a geological model it becomes apparent that changes need to be made to the well data, you can import additional data or create a new column using the split lithology, group lithology or interval selection tools.

To create a new intrusion from lithology contacts, right-click on the **Surface Chronology** object and select either **New Intrusion > From Base Lithology** or **New Intrusion > From Other Contacts**. The only difference in the two methods is that when creating an intrusion from other contacts, you must first select the lithology column from those available in the project and specify the **First lithology** and the **Second lithology**.

Select the intrusive lithology as the interior lithology. Other lithologies will be displayed in the **Exterior lithologies** list. Drag any younger lithologies to the **Ignore** list.

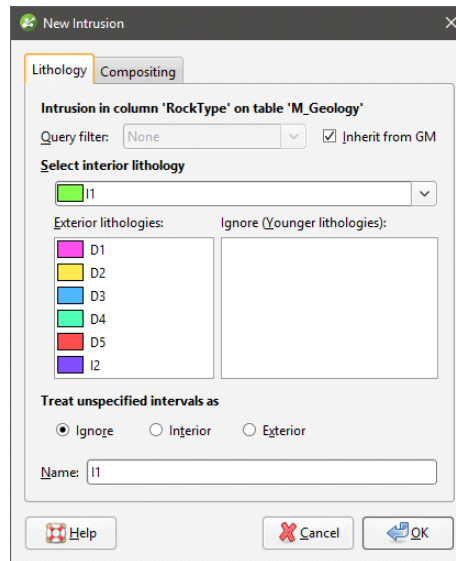

Unspecified intervals are intervals that have no data. By default, unspecified intervals are ignored when creating an intrusion, but you can also treat them as the interior lithology or as exterior lithologies.

Sometimes intrusive boundaries are poorly defined, with fragments of country rock intermixed with the intrusive body. This can result in very small segments near the edges of the intrusion. Modelling the fine detail is not always necessary, and so compositing can be used to smooth these boundaries. Compositing parameters are set in the **Compositing** tab:

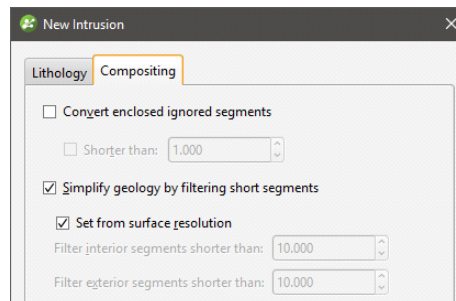

The settings in this tab are described in [Category Composites](#).

Click **OK** to create the intrusion, which will be added to the project tree as part of the **Surface Chronology** object.

Intrusions from Other Data

If suitable lithology data is not available, intrusions can be created from other data in the project, such as GIS data, structural data, points, polylines and surfaces. The steps for creating intrusions from other data are similar, regardless of the data used to create the surface:

- Right-click on the **Surface Chronology** and select one of the data types from the **New Intrusion** menu.

- Select the data object that will be used to define the surface. This must already be in the project, unless you are using a polyline, in which case you are given the option to create a new polyline.
- Select the **First lithology** and **Second lithology**. These are the lithologies that will be assigned to each side of the contact surface. The lithologies you can choose from are those defined for the geological model in the **Lithologies** object (see [Model Lithologies](#)).
- Set whether the **First lithology** is older or younger than the **Second lithology**. Leapfrog Geothermal will, by default, put the younger side of a contact surface up, but this can be changed later.

Here, a points data object is being used to create an intrusion:

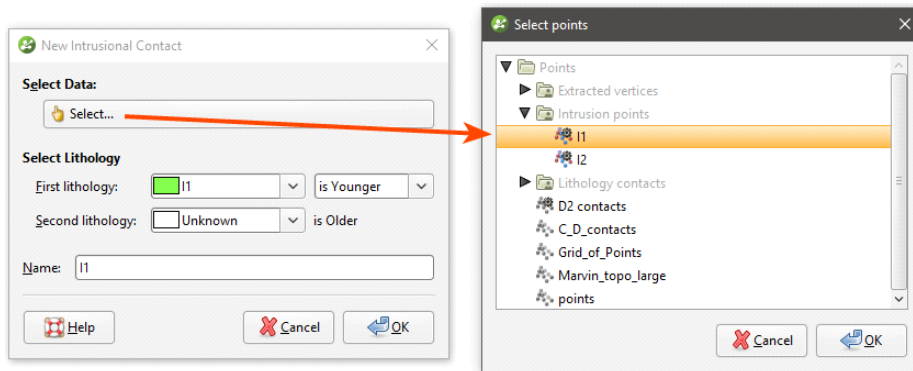

For polylines, you first set the lithologies and the younging order:

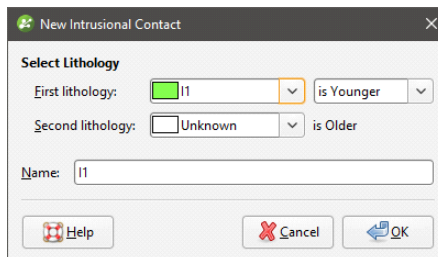

Click **OK** to move on to the next step:

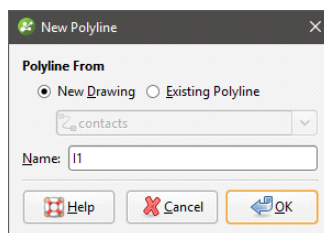

You can draw the polyline in the scene directly by selecting the **New Drawing** option. You can also use any polyline in the project by selecting the **Existing Polyline** option. You can then select the required polyline from the list.

The new intrusion will appear in the project tree under the **Surface Chronology**. Add the contact surface to the scene to view it and check that it is oriented correctly.

Expand the surface in the project tree to see how it was made.

If creating a surface from a new polyline, the polyline will not be able to be used elsewhere in the project unless it has been shared. To share the polyline, expand the contact surface in the project tree, right-click on the polyline and select **Share**. The polyline will then be available elsewhere in the project.

As further refinements are made to the surface, that information will also be added to the contact surface in the project tree.

Intrusions in the Project Tree

The name Leapfrog Geothermal automatically assigns to an intrusion is the name of the intrusive lithology. In the project tree, expand the intrusion to see how it was made:

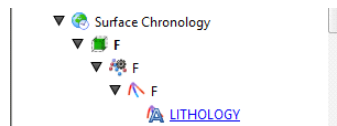

Double-click on the intrusion to edit it. Double-click on the points object (🔗) to edit the intrusion lithology, change compositing parameters and change point generation options.

As further refinements are made to the surface, that information will also be added to the project tree. See [Refining Intrusions](#) below for more information.

Displaying Intrusion Points

When you view the intrusion points in the scene, you can display only the contact points or all the points used in creating the intrusion. To display all points, click on the points object (🔗) in the shape list and tick the box for **Show volume points**. Here, only the contact points are displayed:

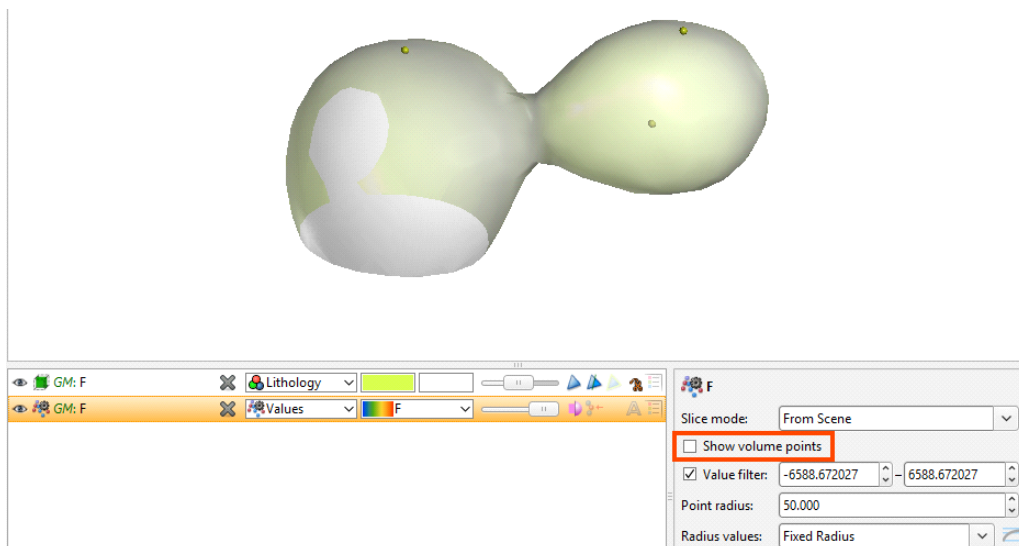

When the volume points are displayed, points with negative values are those outside the surface, while points with positive values are those inside:

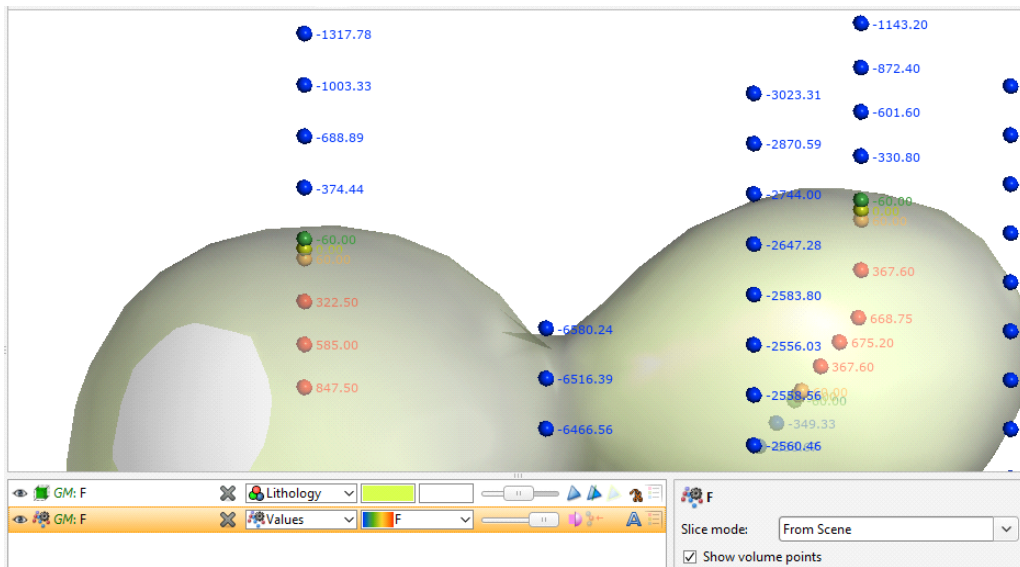

You can change the way intrusion points are generated by double-clicking on the points object () in the project tree. See [Intrusion Point Generation Parameters](#).

Refining Intrusions

You can refine intrusions in several ways:

- Add other data. Right-click on the surface to see the options available, which will depend on how the surface was created. See [Adding Data to Surfaces](#) for more information.
- Edit the surface with a polyline. Right-click on the surface in the project tree and select either **Edit > With Polyline**. See [Editing Surfaces with Polylines](#) for more information.
- Edit the surface using structural data. Right-click on the surface and select **Edit > With Structural Data**. See [Editing Surfaces with Structural Data](#) for more information.

To edit an intrusion’s settings, double-click on it in the project tree. In the **Lithologies** tab, change the lithologies assigned to each side of the surface, if required.

Surfacing Options for Intrusions

Surfacing options for an intrusion can be changed by double-clicking on the surface in the project tree and then clicking on the **Surfacing** tab. There are additional settings related to boundary filtering and snapping to data in the **Inputs** tab.

Boundary Filtering

When data objects are added to a surface, there are two ways to handle the data that lies outside the surface’s boundary:

- Filter the data. The surface is only influenced by the data that falls inside the surface’s boundary.

- Leave the data unfiltered. The surface is influenced by the data both inside and outside the surface's boundary.

The boundary of an intrusion can be the geological model boundary or a fault block boundary.

The **Boundary filter** setting determines how data used to define the surface is filtered:

- **Off.** Data is not filtered.
- **All data.** All data is filtered.
- **Drilling only.** Only well data and data objects derived from well data are filtered.
- **Custom.** Only the data objects specified in the **Inputs** tab are filtered.

Snapping to Data

Often, surfaces should honour well data and treat data objects such as polylines and GIS data as interpretations, as discussed in [Honouring Surface Contacts](#).

There is a **Snap to data** setting for a geological model as a whole that is set in the **Geological Model > General** tab (see [Editing a Geological Model](#)). **Snap to data** can also be set on a surface-by-surface basis by double-clicking on the surface in the project tree and then clicking on the **Surfacing** tab.

For individual contact surfaces, the options are:

- **Inherit from GM.** The setting for the geological model as a whole is used. This is the default setting.
- **Off.** Surfaces do not snap to the data used to create them.
- **All data.** Surfaces snap to all data within the **Maximum snap distance**, which includes well data and any data added to the surfaces.
- **Drilling only.** Surfaces snap to well data and data objects derived from well data within the **Maximum snap distance** but not to other data used to modify the surfaces.
- **Custom.** Surfaces snap to the data objects indicated in the **Inputs** tab for each surface.

Take care in enabling snapping and in selecting what data the surface will snap to, as the more data you include, e.g. by setting a large **Maximum snap distance** or selecting **All data** for **Snap to data**, the greater the possibility that errors in the data or assumptions inherent in interpretations (e.g. polylines) will cause distortions in the meshes. If you do enable snapping, it is best to snap only to drilling data. See [Honouring Surface Contacts](#) for more information on these settings.

If you need a surface to honour well data but treat other data objects as interpretations, select **Drilling only**. To honour some data objects while treating others as interpretations, select **Custom**, then click on the **Inputs** tab to enable snapping for individual objects.

Surface Resolution

See [Surface Resolution for a Geological Model](#) for information about the surface resolution settings in the **Surfacing** tab.

Clicking **Additional options** adds **Value Clipping** and **Interpolant** tabs to the window and also allows the use of a structural trend in the **Trend** tab:

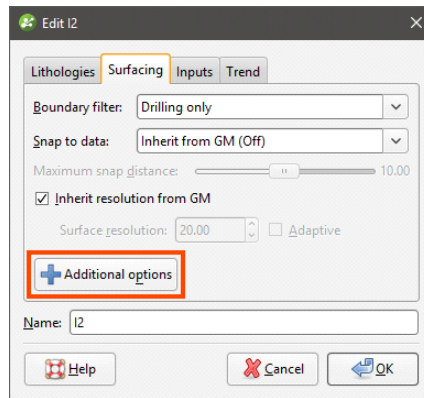

These are described in [Applying a Trend to an Intrusion](#), [Clipping Values for Intrusions](#) and [Interpolation Settings](#) below.

Applying a Trend to an Intrusion

There are two ways to change the trend for an intrusion:

- Right-click on the surface in the project tree and select **Adjust Surface**.
- Double-click on the surface in the project tree and then click on the **Trend** tab.

See [Global Trends](#) for more information.

You can also use a structural trend for an intrusion. To do this, click the **Additional options** button in the **Surfacing** tab, then click on the **Trend** tab.

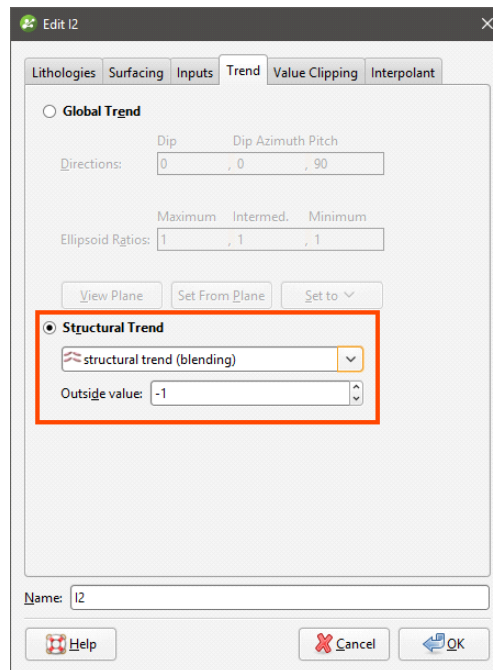

Click on **Structural Trend**, then select the required trend from the list. See [Structural Trends](#) for more information.

Clipping Values for Intrusions

You can change settings for intrusions by double-clicking on the contact surface in the project tree. The **Value Clipping** tab is only available for intrusion contact surfaces.

In the **Value Clipping** tab, you can manipulate the data distribution by clipping the data:

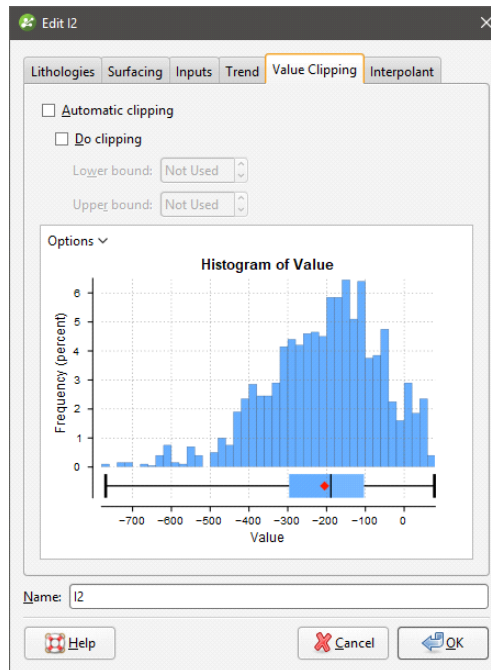

Clipping caps values that are outside the range set by the **Lower bound** and **Upper bound** values. For example, if you change the **Upper bound** from 16.00 to 10.00, distance values above 10.00 will be regarded as 10.00.

The **Automatic clipping** setting has different effects based on whether a global trend or structural trend is set in the **Trend** tab:

- When a global trend is applied, Leapfrog Geothermal automatically clips the values. That is, the **Automatic clipping** setting is **Do clipping** and Leapfrog Geothermal sets the **Lower bound** and **Upper bound** from the data. To disable clipping, untick **Automatic clipping**, then untick **Do clipping**. To change the **Lower bound** and **Upper bound**, untick **Automatic clipping**, then change the values.
- When a structural trend is applied, Leapfrog Geothermal automatically does not clip the values. To clip values, untick **Automatic clipping**, then tick **Do clipping**. Again, Leapfrog Geothermal sets the **Lower bound** and **Upper bound** values from the data and you can change them, if required.

Interpolation Settings

You can change settings for an intrusion by double-clicking on the intrusion in the project tree and clicking on the **Interpolant** tab. For more information on the settings in this tab, see:

- [Interpolant Functions](#)
- [The Spheroidal Interpolant Function](#)
- [The Linear Interpolant Function](#)

Veins

This topic describes creating and editing veins. It is divided into:

- [Creating Veins](#)
- [Veins in the Project Tree](#)
- [Displaying Veins](#)
- [Refining Veins](#)
- [Surfacing Options for Veins](#)
- [The Vein Reference Surface](#)
- [The Vein Boundary](#)
- [Editing Vein Segments](#)

For a general introduction to how veins interact with other contact surfaces, see [Vein Contact Surfaces](#) in [Contact Surfaces](#).

A vein is a type of contact surface that removes existing lithologies and replaces them with the vein lithology within the boundaries defined by hangingwall and footwall surfaces constructed from selected input data. A reference surface is defined that is the best fit for the hangingwall and footwall surfaces. The reference surface can be curved or planar.

Creating Veins

Options for creating veins are:

- From lithology data, using the base lithology used to define the geological model or other contacts available in the project. See [Veins From Lithology Contacts](#) below.
- From GIS vector data, point data and polylines. See [Veins From Other Data](#) below.
- Creating a vein system. This results in a single lithology that represents all the veins in a model. Veins and their interactions are defined within the vein system. See [Vein Systems](#).

Veins From Lithology Contacts

To create a new vein from lithology contacts, right-click on the **Surface Chronology** object and select either **New Vein > From Base Lithology** or **New Vein > From Other Contacts**. The only difference in the two methods is that when creating a vein from other contacts, you must first select the lithology column from those available in the project and specify the **Vein lithology** and **Outside lithology**.

In the **New Vein** window, select the **Vein lithology**:

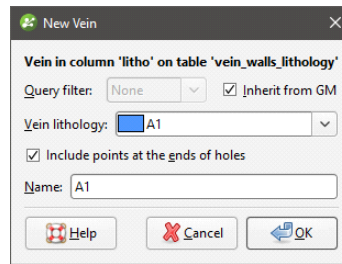

When extracting the hangingwall and footwall points, Leapfrog Geothermal automatically includes points at the ends of the wells. To exclude these points, untick the **Include points at the ends of holes**. Once the vein has been created, this setting can be changed by double-clicking on the vein segments object (📍) in the project tree.

Click **OK** to create the vein, which will be added to the project tree as part of the **Surface Chronology** object.

Veins From Other Data

If suitable lithology data is not available, veins can be created from other data in the project, such as GIS data, points and polylines. The steps for creating veins from other data are similar, regardless of the data used to create the surface:

- Right-click on the **Surface Chronology** and select one of the data types from the **New Vein** menu.
- Select the data objects for the **Hangingwall** and **Footwall**. These objects must already be in the project.
- Select the **Vein lithology** and the **Outside lithology**. The lithologies you can choose from are those defined for the geological model in the **Lithologies** object (see [Model Lithologies](#)).

Here, points data is being used to create a vein:

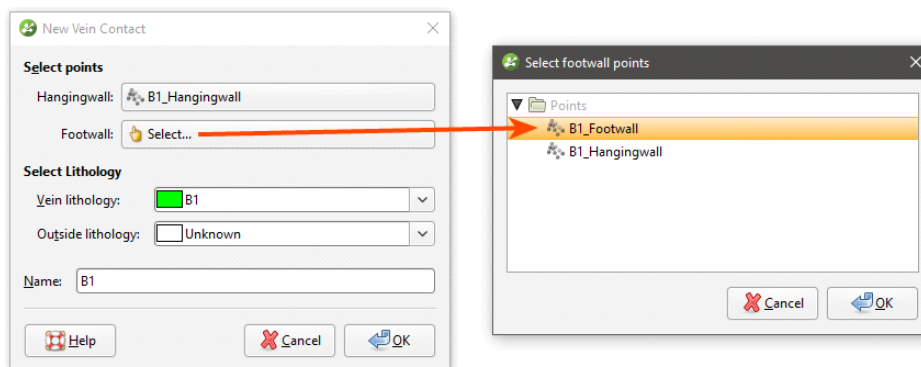

Select points data objects for both the **Hangingwall** and **Footwall**, then click **OK** to create the new vein. The new contact surface will appear in the project tree under the **Surface Chronology**. Expand the vein in the project tree to see how it was made.

Veins in the Project Tree

Veins are stored in the project tree as part of the **Surface Chronology** object. Further modifications can be made to the vein by working on the objects that make up the vein. Expand the vein in the project tree to view these objects.

Here, the hangingwall and footwall surfaces and points are displayed in the scene for a vein defined from lithology data. The reference surface (yellow) and the vein segments (red and blue cylinders) used to create the vein are also shown:

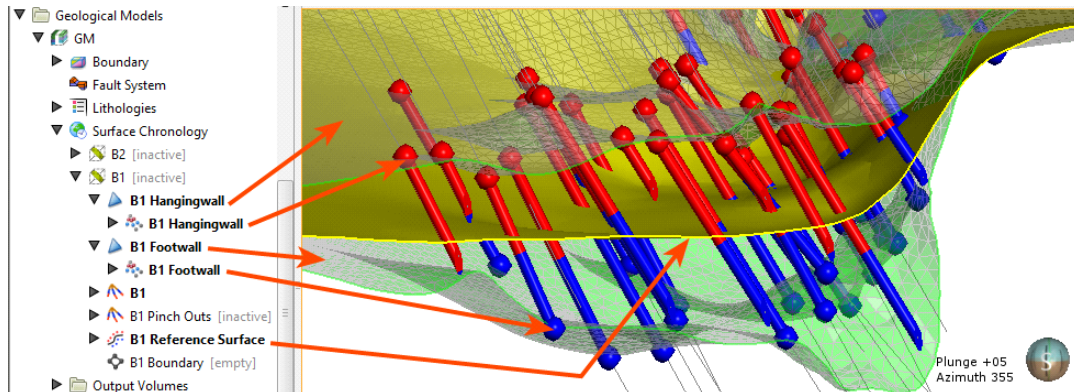

This vein is made up of:

- Hangingwall and footwall surfaces (📐), which, when expanded, show the hangingwall and footwall data objects used to create the surfaces.
 - Export hangingwall and footwall surfaces as described in [Exporting Meshes](#) and [Exporting an Elevation Grid](#).
 - Add points and GIS vector data to the meshes by right-clicking on them and selecting **Add**.
 - Edit the hangingwall and footwall surfaces with polylines by right-clicking on the surface and selecting one of the **Edit** options.
 - Change contact honouring and boundary filtering options as described in [Surfacing Options for Veins](#) below.
- Vein segments and pinch out segments (📏) extracted from well data. These are only included when a vein is created from lithology contacts.
- A reference surface (📐) calculated as the best fit surface using the hangingwall and footwall surfaces.
 - The reference surface can be curved or planar.
 - You can add points, GIS vector data and polylines to a curved reference surface.
 - If a curved reference surface is made up of multiple objects, you can switch between the objects and change how they are filtered in order to see the effects on the vein.
- A boundary object (📏), which is empty when the vein is first created.

It is not possible to add structural data or polylines with orientation information to the hangingwall, footwall and reference surfaces. If you edit these surfaces with a polyline, your options for editing the polyline will be limited.

Displaying Veins

You can change the way the different objects that make up the vein are displayed using options in the shape list:

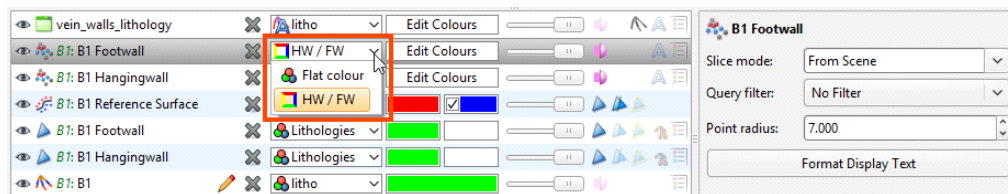

Refining Veins

To edit a vein's settings, double-click on it in the project tree. In the **Lithologies** tab, change the lithologies assigned to each side of the surface, if required. For information on the settings in the **Surfacing** and **Inputs** tabs, see [Surfacing Options for Veins](#) below.

Surfacing Options for Veins

Surfacing options for veins can be changed by double-clicking on the surface in the project tree and then clicking on the **Surfacing** tab. There are additional settings related to boundary filtering and snapping to data in the **Inputs** tab.

Boundary Filtering

When data objects are added to a surface, there are two ways to handle the data that lies outside the surface's boundary:

- Filter the data. The surface is only influenced by the data that falls inside the surface's boundary.
- Leave the data unfiltered. The surface is influenced by the data both inside and outside the surface's boundary.

The boundary of a vein can be the geological model boundary or a fault block boundary.

The **Boundary filter** setting determines how data used to define the surface is filtered:

- **Off**. Data is not filtered.
- **All data**. All data is filtered.
- **Drilling only**. Only well data and data objects derived from well data are filtered.
- **Custom**. Only the data objects specified in the **Inputs** tab are filtered.

The **Filter segments by boundary** setting in the **Inputs** tab is enabled by default when the **Boundary filter** setting in the **Surfacing** tab is **All data** or **Drilling only**. When **Filter segments**

by **boundary** is enabled, the vein surface will only be influenced by the segments that falls inside the vein boundary.

Snapping to Data

Often, surfaces should honour well data and treat data objects such as polylines and GIS data as interpretations, as discussed in [Honouring Surface Contacts](#).

There is a **Snap to data** setting for a geological model as a whole that is set in the **Geological Model > General** tab (see [Editing a Geological Model](#)). **Snap to data** can also be set on a surface-by-surface basis by double-clicking on the surface in the project tree and then clicking on the **Surfacing** tab.

For individual contact surfaces, the options are:

- **Inherit from GM.** The setting for the geological model as a whole is used. This is the default setting.
- **Off.** Surfaces do not snap to the data used to create them.
- **All data.** Surfaces snap to all data within the **Maximum snap distance**, which includes well data and any data added to the surfaces.
- **Drilling only.** Surfaces snap to well data and data objects derived from well data within the **Maximum snap distance** but not to other data used to modify the surfaces.
- **Custom.** Surfaces snap to the data objects indicated in the **Inputs** tab for each surface.

Take care in enabling snapping and in selecting what data the surface will snap to, as the more data you include, e.g. by setting a large **Maximum snap distance** or selecting **All data** for **Snap to data**, the greater the possibility that errors in the data or assumptions inherent in interpretations (e.g. polylines) will cause distortions in the meshes. If you do enable snapping, it is best to snap only to drilling data. See [Honouring Surface Contacts](#) for more information on these settings.

If you need a surface to honour well data but treat other data objects as interpretations, select **Drilling only**. To honour some data objects while treating others as interpretations, select **Custom**, then click on the **Inputs** tab to enable snapping for individual objects.

Surface Resolution

Note that although you can change the **Surface resolution** for a vein, the **Adaptive** option is not available, even when the resolution for the geological model is set to be **Adaptive**.

Vein Thickness

Veins have two thickness settings that force the vein to maintain a minimum or maximum thickness. If footwall and hangingwall points are in pairs, it is not usually necessary to set the **Minimum thickness** or **Maximum thickness**.

- If the vein intersects itself, set the **Minimum thickness** to a value that is less than the minimum distance between any two contact points.
- If the vein widens out toward the edges of the geological model set the **Maximum thickness** to a value that limits the effects of long segments.

If the **Pinch out** option is enabled, you will not be able to set the **Minimum thickness**.

If you set the **Maximum thickness** and **Pinch out**, the **Pinch out** is applied before the **Maximum thickness**.

Note that if **Snap to data** is enabled, snapping occurs after the vein thickness has been calculated. If it appears that the vein surface is not honouring the thickness setting, check what data the surface is snapping to.

Vein Pinch Out

Vein walls can be set to pinch out where well data indicates they do not occur. This is achieved by creating 'outside' intervals on wells that do not have an interior vein segment. These intervals are then flipped with respect to interior vein intervals, which, in effect means the footwall and hangingwall orientation has the opposite sense to the nearest interior intervals. This forces the hangingwall and footwall surfaces to cross, thereby pinching out.

The **Pinch out** option is disabled when a vein is first created. To enable it, double-click on the vein in the project tree and click on the **Surfacing** tab. Tick the box for **Pinch out**. Click **OK** to process the changes. The vein will be updated and pinch out points (↗) will be added to the vein in the project tree.

For this vein, the surface occurs even where the vein lithology (green cylinders) does not occur and terminates at the boundary of the geological model:

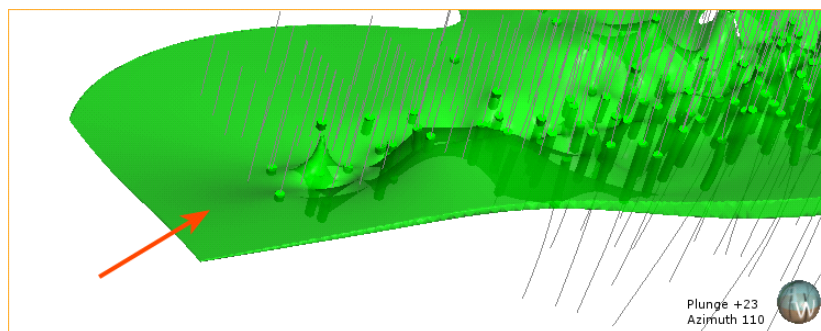

When the vein is set to pinch out, it tapers out where the vein lithology does not occur:

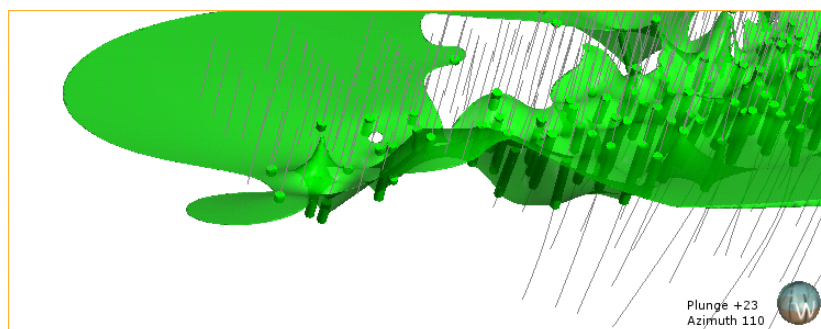

You can change how much the vein pinches out by excluding some pinch out segments. To do this, right-click on the pinch out segments (📌) in the project tree and select **Edit in Scene**. The **Pinch Out Properties** window will appear in the scene. Click on a segment to view information about it and set it to be **Excluded**, if required. Note that the segments displayed in the scene below are the pinch out segments rather than the well segments shown in earlier scenes. The grey segments are excluded and the currently selected segment is highlighted in the scene:

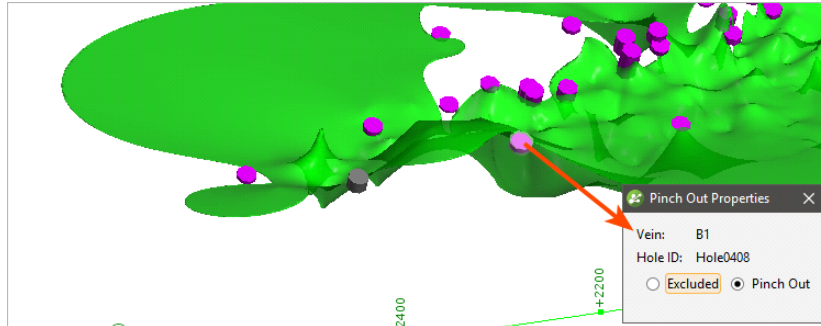

Click the **Save** button (💾) to view the effect of the excluded pinch out segments on the vein. Excluding the two segments results in the vein terminating at the boundary of the geological model:

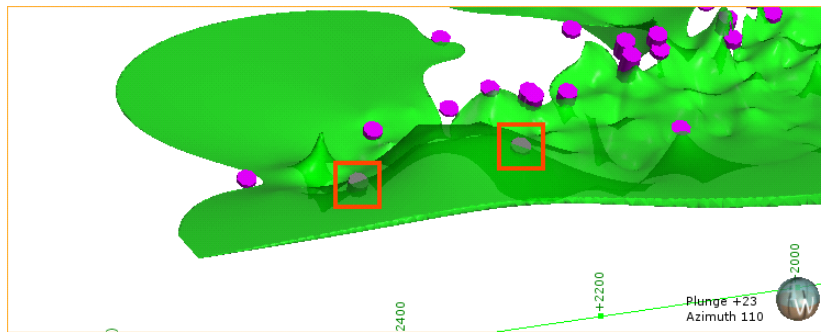

The Vein Reference Surface

A vein includes a reference surface (📐) that is the best fit for the objects that make up the hangingwall and footwall surfaces. There are two types of reference surface.

- **Curved.** A curved reference surface can be used to make a vein follow the medial trend of the source data, which leads to a more natural modelled shape. This is the type of reference surface used by default for veins created from lithology data. A curved reference surface can be used for veins created from other types of data by adding data to the reference surface, as described in [Adding Data to the Reference Surface](#).
- **Planar.** A planar reference surface is simply the best linear fit between the hangingwall and footwall surfaces. See [Using a Planar Reference Surface](#).

To adjust the reference surface (📐), double-click on it in the project tree or right-click on it and select **Open**. The **Reference Surface** window will appear, showing the data used to for the reference surface. This is the reference surface for a vein created from lithology data, and so the midpoints for the vein lithology are used as **Input values**:

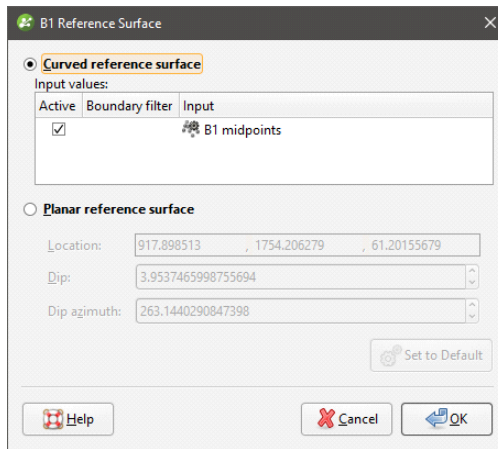

Boundary filtering for the midpoints used to create a curved reference is controlled by the setting for the vein itself. See [Boundary Filtering](#) in [Surfacing Options for Veins](#) for more information.

Adding Data to the Reference Surface

In order for a vein created from data other than lithology data to use a curved reference surface, other data must be added to it.

It is not possible to add structural data or polylines with orientation information to the reference surface. If you edit the reference surface with a polyline, your options for editing the polyline will be limited.

To add data, right-click on the reference surface in the project tree and select **Add** or **Edit**. Once you have added data, the **Curved reference surface** option will be enabled in the **Reference Data** window and the objects used to adjust the surface will appear in the list of **Input values**:

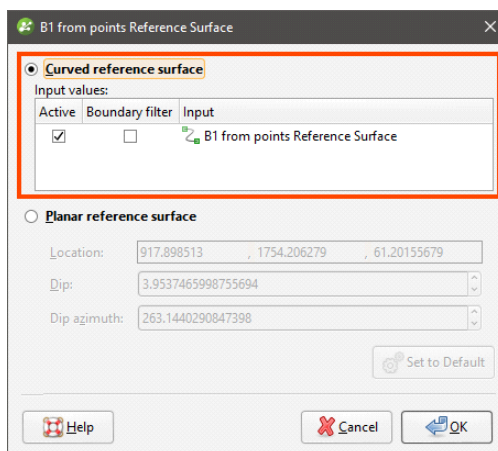

You can enable or disable the different data objects to see their effects on the vein by ticking and unticking the **Active** box.

The **Boundary filter** setting for each object determines whether or not the data that lies outside the reference surface's boundary is filtered.

- Tick **Boundary filter** so that the surface is only influenced by the data that falls inside the reference surface's boundary.
- Untick **Boundary filter** if you want the surface to be influenced by the data both inside and outside the reference surface's boundary.

Click **OK** to process the changes.

Using a Planar Reference Surface

Veins created from objects other than lithology data use a planar reference surface, and this option can also be selected for veins created from lithology data. To use a planar reference surface, select the **Planar reference surface** option in the **Reference Surface** window. The plane will be displayed in the scene, together with handles that can be used to adjust it:

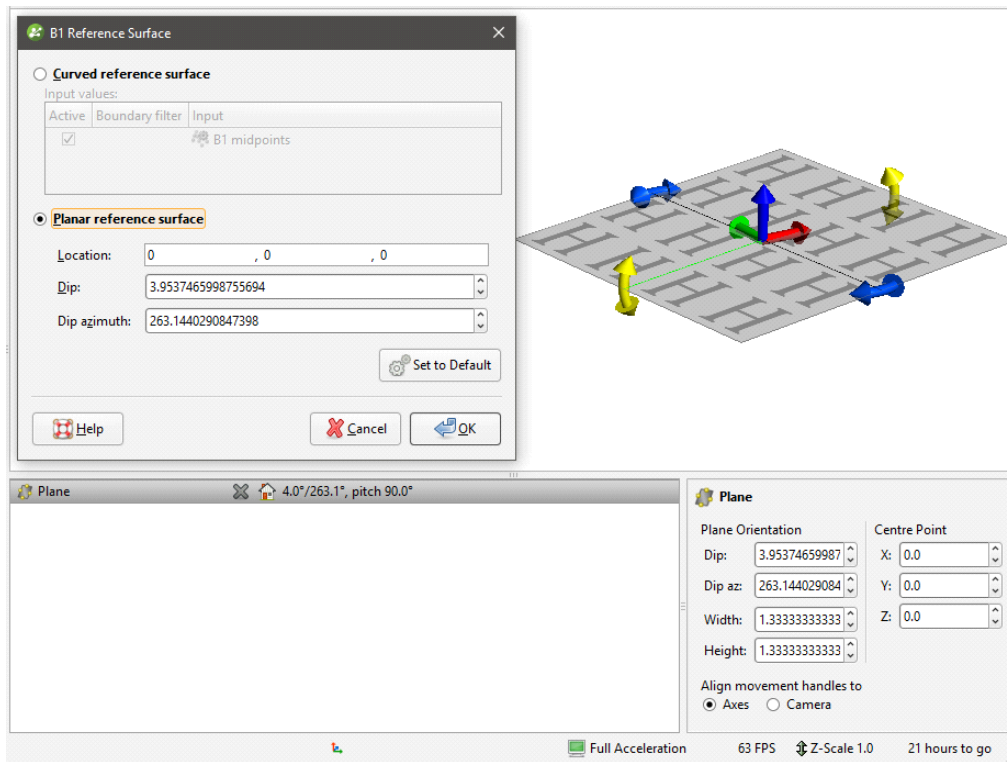

These handles work in the same manner as the moving plane controls, as described in [The Moving Plane](#).

Click **OK** to update the reference surface and view the results.

The Vein Boundary

Once a vein has been created, you can change its boundary by:

- [Adding a Polyline to the Vein Boundary](#)
- [Adjusting the Vein Boundary Plane](#)

Adding a Polyline to the Vein Boundary

To change the boundary using a polyline, right-click on the boundary object (📌) in the project tree and select **Edit**. The current vein boundary will appear in the scene, together with drawing controls. Begin drawing the new boundary, as described in [Drawing in the Scene](#), ensuring that the polyline drawn closes and does not intersect itself.

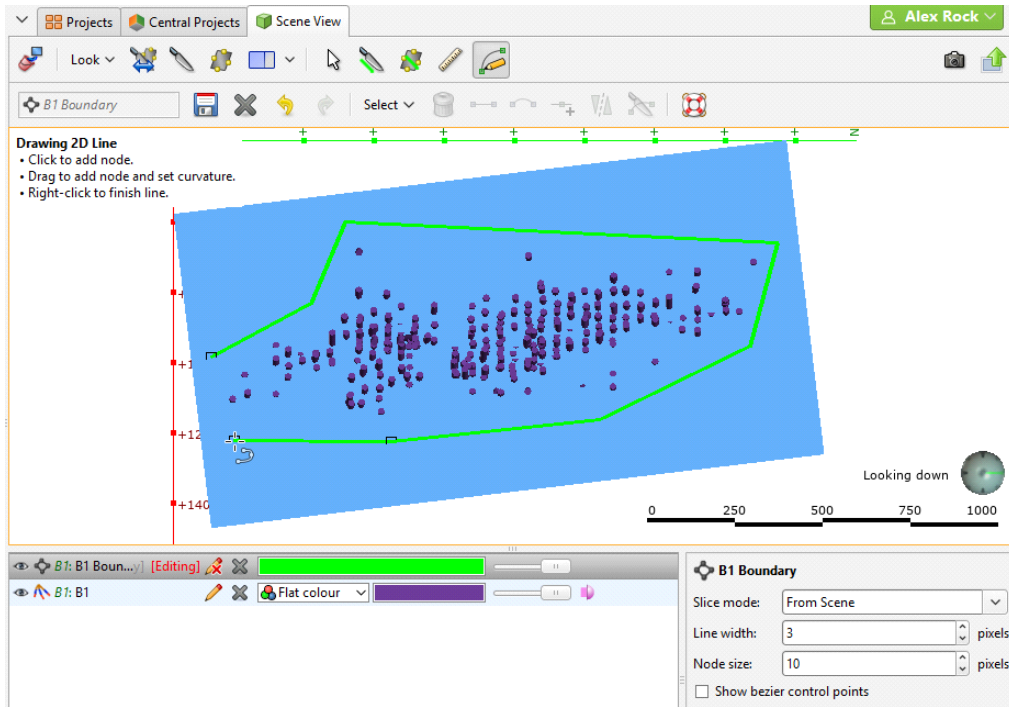

When you save the boundary, the vein will be updated to reflect the changes to the boundary. If you want to revert to the original boundary, right-click on the boundary object (📌) and select **Delete Polyline**.

Adjusting the Vein Boundary Plane

To adjust the boundary plane, right-click on the boundary object (📌) in the project tree and select **Adjust Plane**. The **Adjust Boundary Plane** window will appear and handles to adjust the plane will appear in the scene:

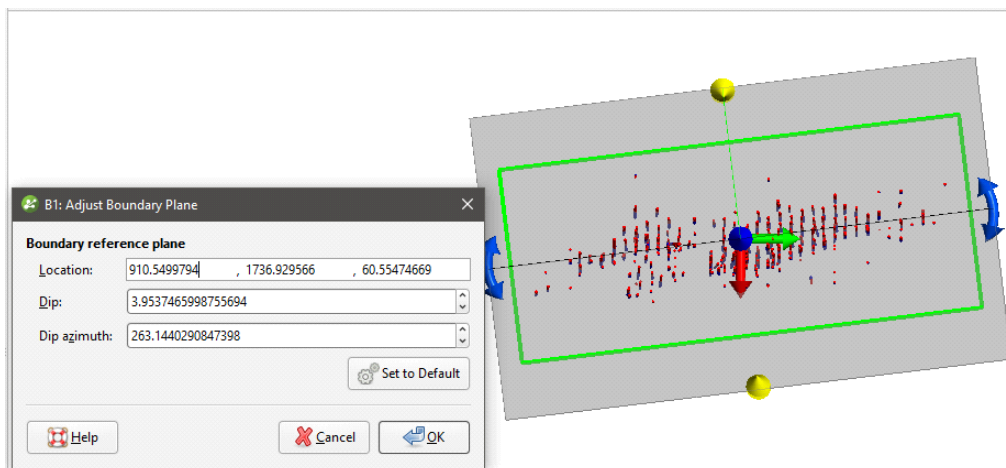

Click **OK** to apply the changes to the vein. To revert to the original boundary plane, right-click on the boundary object and select **Adjust Plane**. In the **Adjust Boundary Plane** window, click on the **Set to Default** button and click **OK**.

Editing Vein Segments

When a vein has been created from contact points, you can change the vein segment settings by double-clicking on the vein segments object (📁) in the project tree. This opens the **Edit Vein** window.

When extracting the hangingwall and footwall points, Leapfrog Geothermal automatically includes points at the ends of the wells. To exclude these points, untick the **Include points at the ends of holes**.

Vein Segment Orientation

If you need to change the orientation of individual vein segments, e.g. for curved veins, you can do this by right-clicking on the vein segments object (📁) in the project tree and selecting **Edit In Scene**. If the vein segments object is already in the scene, you can edit it by clicking the **Edit** button (✎) in the shape list.

The **Vein Segment Orientations** window will appear in the scene. Click on a vein segment to view information about that segment:

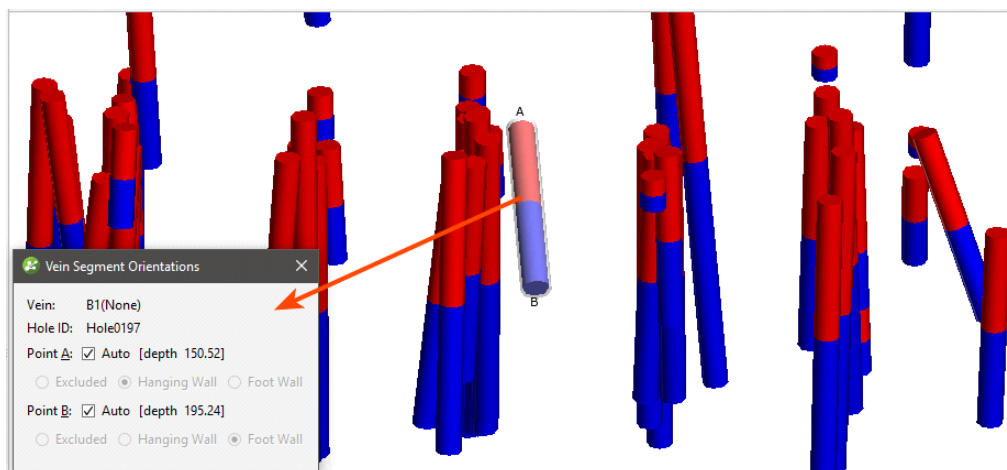

Points A and B are labelled in the scene and can be changed by unticking the box for each point and choosing whether to exclude the point or make it a hangingwall or footwall point. Once you have finished editing vein segments, click the **Save** button (💾).

If you wish to return to the default settings, ensure the **Auto** box is ticked for each point.

Vein Systems

This topic describes creating a vein system for a geological model. The topic is divided into:

- [Creating a Vein System](#)
- [Adding Veins to the Vein System](#)
- [Editing the Veins](#)

- [Changing Vein System Lithology Settings](#)
- [Setting Vein Interactions](#)

An alternative to defining veins one-by-one is to create a vein system. The vein system represents a single lithology within the geological model. For example, for a model of a sedimentary system cross-cut by vertical intersecting dykes, we could model the veins one-by-one, in which case each “vein” in the model is represented by a separate lithology:

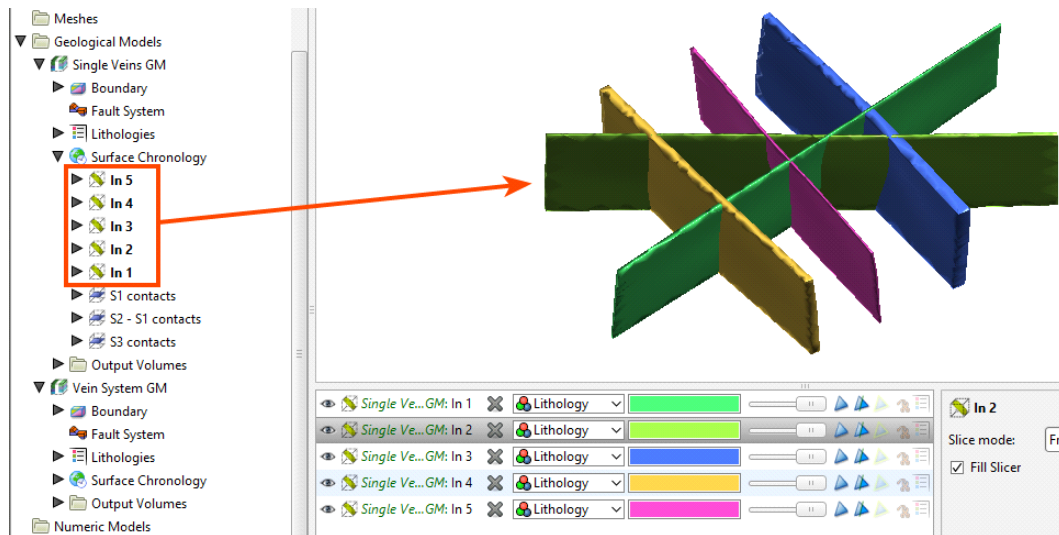

Modelled as a vein system, however, the veins are grouped into a vein system object (👉) that defines the lithology for the vein system as a whole:

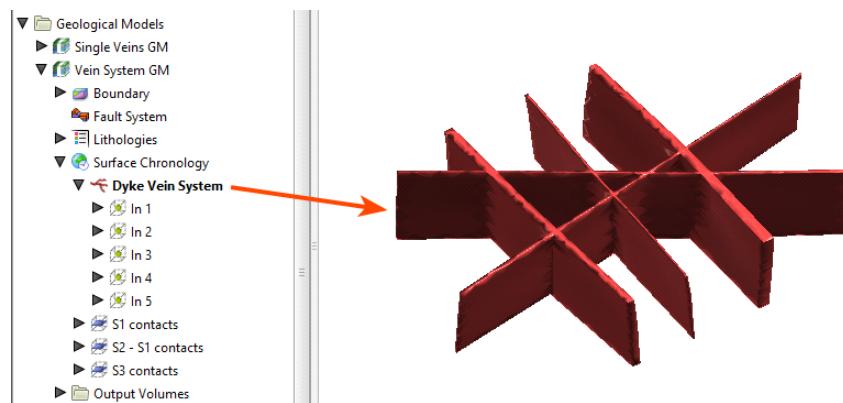

Note that the individual veins are part of the vein system.

The vein system defines how the veins interact, and veins can be added to it using the same techniques used to create individual veins.

Creating a Vein System

To create a vein system, right-click on the **Surface Chronology** and select **New Vein System**. In the window that appears, select the **Vein lithology**:

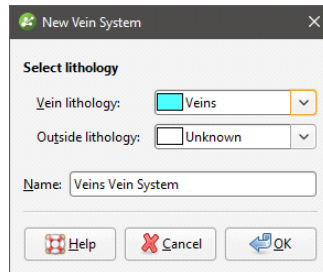

If the vein system contacts only one lithology, set the **Outside lithology**. Otherwise, leave **Outside lithology** set to Unknown.

Click **OK**. An empty vein system (🔍) will be added to the project tree under the **Surface Chronology**. Double-click on it to change the lithologies.

Adding Veins to the Vein System

Once the vein system has been created, you can create veins using the same techniques described in [Veins From Lithology Contacts](#) and [Veins From Other Data](#).

To add veins to the vein system, right-click on the vein system and select one of the **New Vein** options. Veins will appear in the project tree as part of the vein system object and can be expanded to show how they were created.

Editing the Veins

The techniques for editing vein system veins are the same as those for veins created one-by-one. See [Refining Veins](#).

Changing Vein System Lithology Settings

You can change the lithology settings for a vein system by double-clicking on the vein system (🔍) in the project tree. In the **Lithology** tab, change the **Vein lithology** or the **Outside lithology**.

Setting Vein Interactions

Once all the veins required have been created, you can start defining the interactions between them by double-clicking on the vein system (🔗), then clicking on the **Vein System** tab:

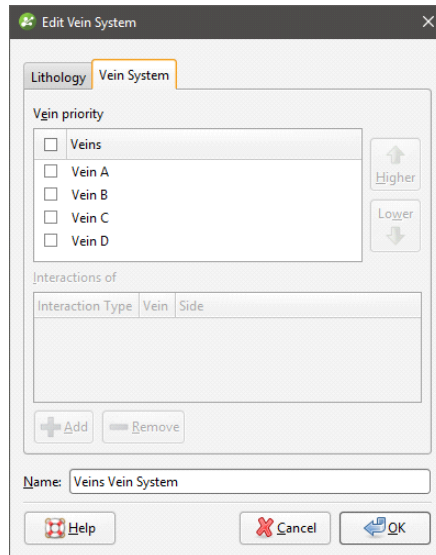

The veins appear in the list from highest priority to lowest. Organise the veins in chronological order before defining interactions.

The **Vein priority** determines which veins other veins can interact with. You cannot define an interaction for the highest priority vein in the list, and other veins in the list can interact only with those of higher priority.

Here, Vein B can only interact with Vein A, the higher priority vein:

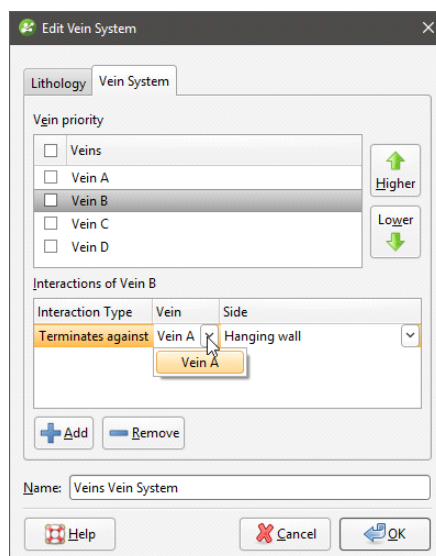

The lowest priority vein, Vein D, can interact with all the other veins in the system:

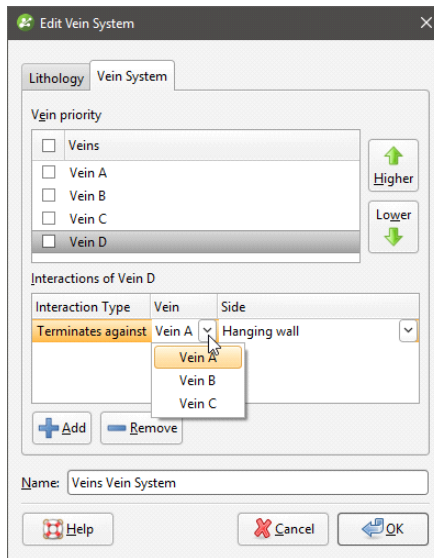

To define an interaction, click on a vein, then click the **Add** button. Add an interaction for each vein and then set the **Side** on which they interact.

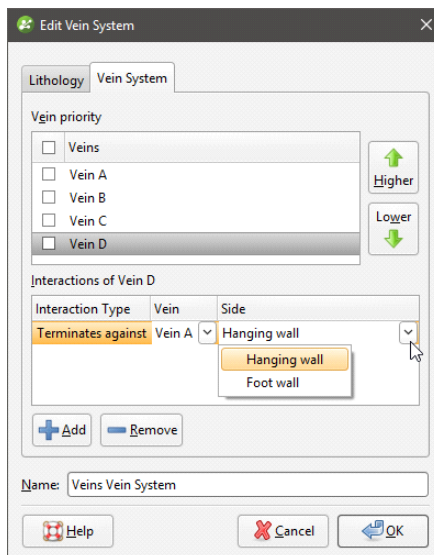

Once you have defined the required vein interactions, tick the box for each vein, then click **OK**. Add the **Vein System** object to the scene to check that the veins interact correctly.

You can also edit vein interactions by double-clicking on the individual veins, which opens the **Edit Vein** window:

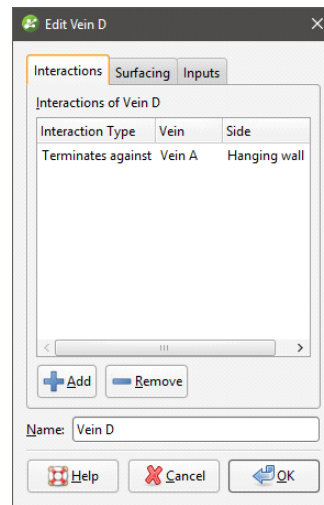

Veins and the vein system are not active in the geological model until the box is ticked for each vein in the **Edit Vein System** window and the vein system is enabled in the **Surface Chronology**. This means you can check the vein system without regenerating the geological model.

Stratigraphic Sequences

When you have a series of continuous layers in a geological model, you can model each layer separately, as part of a single stratigraphic sequence or using the offset surface tool. Modelling a stratigraphic sequence works best for sequences uniform in thickness with a consistent stacking order. If a layer varies in thickness, the contact surface may not match the contact points in some places. This will be a consideration when choosing whether to model layers as separate layers, as offset surfaces or as part of a stratigraphic sequence. For information on the offset surface tool, see [Offset Surfaces](#).

Once you have created a stratigraphic sequence, you can refine it by adding and removing layers and by adjusting the surfaces produced.

This topic describes using the stratigraphic sequence tool and is divided into:

- [Creating a Stratigraphic Sequence](#)
- [Editing the Stratigraphic Sequence](#)
- [Editing Individual Surfaces](#)

Creating a Stratigraphic Sequence

To create a stratigraphic sequence, right-click on the **Surface Chronology** object and select **New Stratigraphy**. The **New Stratigraphic Sequence** window will appear:

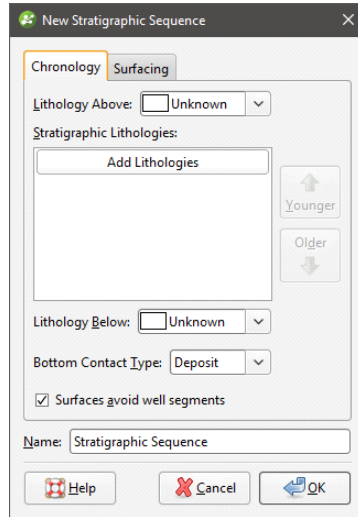

Select the lithologies at the top and bottom of the stratigraphic sequence. To do this, select the **Lithology Above** and **Lithology Below** from the lithologies available in the geological model:

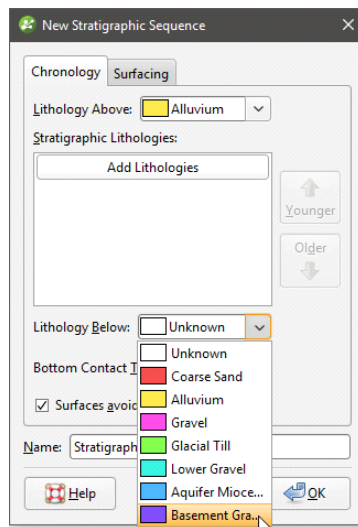

Next, click the **Add Lithologies** button to view available lithologies:

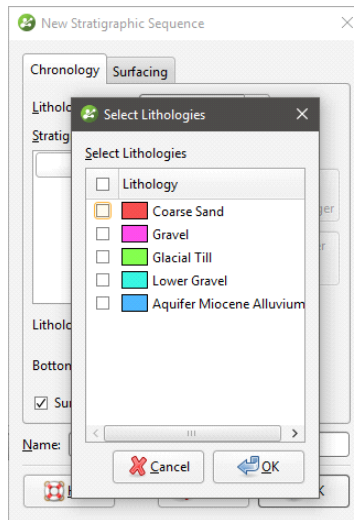

Select the lithologies that you want to use in the stratigraphic sequence, then click **OK** to add the layers to the **Stratigraphic Lithologies** list. Make sure they are arranged in the correct order. In the **New Stratigraphic Sequence** window, select whether the **Bottom Contact Type** is an erosion or a deposit.

When the **Surfaces avoid well segments** option is enabled, the surfaces in the stratigraphic sequence will not cut through intervals of lithologies that are selected for the stratigraphic sequence.

Stratigraphic sequences created in earlier versions of Leapfrog Geothermal (before 2.9) used only the contact information; intervals were ignored and stratigraphic sequence surfaces could cut through intervals. To upgrade a stratigraphic sequence created in earlier versions, edit the stratigraphic sequence to enable **Surfaces avoid well segments**.

Next, click on the **Surfacing** tab to set the surfacing settings for each surface created for the sequence:

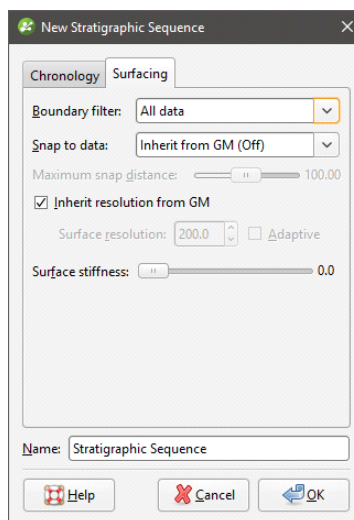

For the **Boundary filter** and **Snap to data** options, it is possible to override these settings for the individual contact surfaces that are part of the stratigraphic sequence. To do this, select

Custom. Once the stratigraphic sequence has been created, expand it in the project tree and double-click on each surface to change its surfacing options, as described in [Contact Honouring and Boundary Filtering for Individual Surfaces](#) below.

Boundary Filtering

When data objects are added to a surface, there are two ways to handle the data that lies outside the surface's boundary:

- Filter the data. The surface is only influenced by the data that falls inside the surface's boundary.
- Leave the data unfiltered. The surface is influenced by the data both inside and outside the surface's boundary.

The **Boundary filter** setting determines how data used to define the surface is filtered:

- **Off.** Data is not filtered.
- **All data.** All data is filtered.
- **Drilling only.** Only well data and data objects derived from well data are filtered.
- **Custom.** Only the data objects specified in the **Inputs** tab are filtered.

All contact surfaces that make up a stratigraphic sequence will inherit the **Boundary filter** setting from the stratigraphy unless **Boundary filter** is set to **Custom**.

Snapping to Data

There is a **Snap to data** setting for a geological model as a whole that is set in the **Geological Model > General** tab (see [Editing a Geological Model](#)). **Snap to data** can also be set on a surface-by-surface basis by double-clicking on the surface in the project tree and then clicking on the **Surfacing** tab.

For a stratigraphic sequence, the options are:

- **Inherit from GM.** The setting for the geological model as a whole is used. This is the default setting.
- **Off.** Surfaces do not snap to the data used to create them.
- **All data.** Surfaces snap to all data within the **Maximum snap distance**, which includes well data and any data added to the surfaces.
- **Drilling only.** Surfaces snap to well data and data objects derived from well data within the **Maximum snap distance** but not to other data used to modify the surfaces.
- **Custom.** Surfaces snap to the data objects indicated in the **Inputs** tab for each surface.

Take care in enabling snapping and in selecting what data the surface will snap to, as the more data you include, e.g. by setting a large **Maximum snap distance** or selecting **All data** for **Snap to data**, the greater the possibility that errors in the data or assumptions inherent in interpretations (e.g. polylines) will cause distortions in the meshes. If you do enable snapping, it is best to snap only to drilling data. See [Honouring Surface Contacts](#) for more information on these settings.

All contact surfaces that make up a stratigraphic sequence will inherit the **Snap to data** setting from the stratigraphy unless **Snap to data** is set to **Custom**.

Surface Stiffness

The **Surface Stiffness** controls the smallest bend a surface will make, where a higher value will result in a smoother surface that bends less. The default value is 0, which is no stiffening.

Click **OK** to create the stratigraphy, which will be added to the project tree as part of the **Surface Chronology** object.

Editing the Stratigraphic Sequence

The objects that make up the stratigraphic sequence include the generated contact surfaces and any points that result in pinch-out errors:

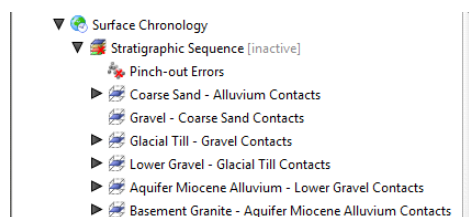

Correcting Pinch-Out Errors

Add the pinch-out errors object (🔍) to the scene to view the points that are causing errors. To find out more about the errors, right-click on the sequence and select **List Errors**.

In the **Stratigraphic Errors** window, information is provided about the different errors that occur in the stratigraphic sequence, with pinch-out errors and other errors listed separately:

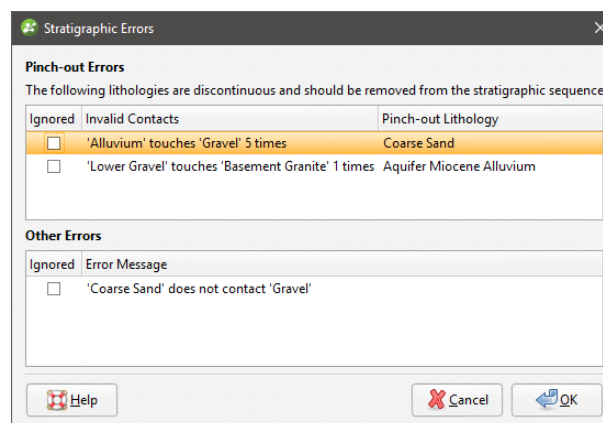

Use this information, together with the pinch-out error points, to either remove lithologies from the sequence or adjust surfaces using any of the tools available for individual surfaces, as described in [Editing Individual Surfaces](#) below.

Remove lithologies from the sequence by double-clicking on the sequence in the project tree, then reorganising the lithologies in the **Chronology** tab. For example, here, the pinch-out errors shown in the window above have been corrected by removing the affected surfaces from the sequence and changing the **Lithology Above** and **Lithology Below**:

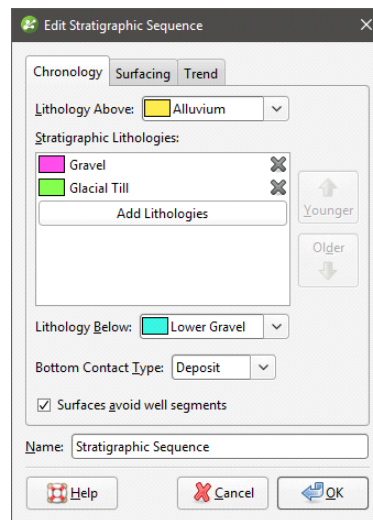

You can also ignore an error by ticking the **Ignored** box in the **Stratigraphic Errors** window.

Surfacing Options

To change a stratigraphic sequence's surfacing options, double-click on the sequence in the project tree and click on the **Surfacing** tab. See [Boundary Filtering](#) and [Snapping to Data](#) above for more information on the settings in this tab. Note that boundary filtering and snap settings can also be set for the individual surfaces that make up the stratigraphic sequence, which is described in [Contact Honouring and Boundary Filtering for Individual Surfaces](#) below.

Applying a Trend

To apply a global trend to a stratigraphic sequence either right-click on it in the project tree and select **Adjust Surface** or double-click on the stratigraphic sequence and then click on the **Trend** tab. You can then apply a trend to the surface as described in [Global Trends](#).

Editing Individual Surfaces

Individual surfaces that make up a stratigraphic sequence can be modified by:

- [Contact Honouring and Boundary Filtering for Individual Surfaces](#)
- [Adding Data to Individual Surfaces](#)
- [Editing Surface Contacts](#)

Contact Honouring and Boundary Filtering for Individual Surfaces

There are general boundary filtering and snap settings for the stratigraphic sequence as a whole, but it is possible to override these settings for the individual surfaces that are part of the stratigraphic sequence. To do this, first double-click on the stratigraphic sequence itself, then click on the **Surfacing** tab.

- To change boundary filtering for an individual surface, **Boundary filter** must be set to **Custom** for the stratigraphic sequence.
- To change the snap setting for an individual surface, **Snap to data** must be set to **Custom** for the stratigraphic sequence.

Next, double-click on an individual surface in the project tree. The window that appears shows all the data objects used to create the surface:

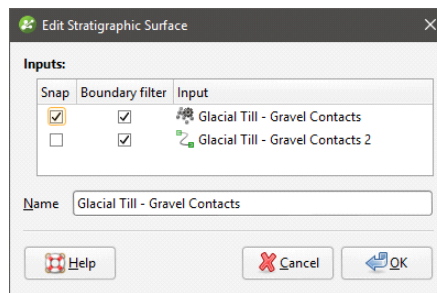

See [Boundary Filtering](#) and [Snapping to Data](#) for more information.

Adding Data to Individual Surfaces

You can also refine the individual surfaces in a stratigraphic sequence in several ways:

- Add other data. Right-click on the surface to see the options available, which will depend on how the surface was created. See [Adding Data to Surfaces](#) for more information.
- Edit the surface with a polyline. Right-click on the surface in the project tree and select either **Edit > With Polyline**. See [Editing Surfaces with Polylines](#) for more information.

It is not possible to add structural data or polylines with orientation information to individual surfaces in a stratigraphic sequence. If you edit a surface with a polyline, your options for editing the polyline will be limited.

Editing Surface Contacts

You can edit the contacts used to generate the surface by expanding the contact surface in the project tree and double-clicking on the points object (*). See [Extracting Contact Points from Well Data](#) for more information on the settings in the **Edit Contacts** window.

Offset Surfaces

The offset surface tool is useful way of creating a series of deposit or erosion contact surfaces from a reference mesh. The surface can be offset from the reference mesh by points or by a

fixed distance, and additional options for offsetting to points can be adjusted once the surface has been created.

Here a deposit contact surface (blue) has been created using the reference mesh (green) offset to points (red):

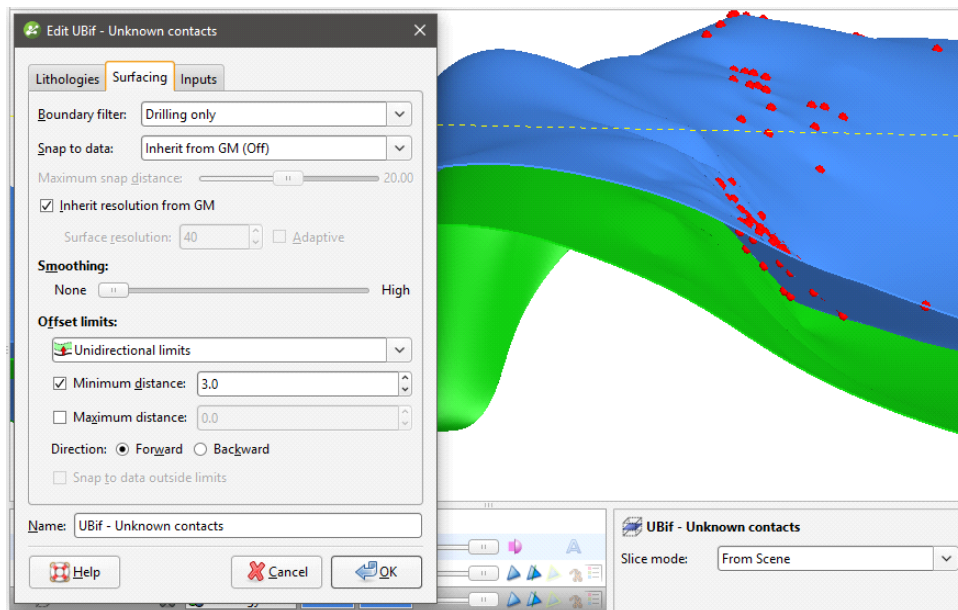

Important considerations when creating offset surfaces is the characteristics of the reference mesh, especially in relation to the geological model's boundary.

- It is best to use a reference mesh that extends beyond the model's boundary. If the reference mesh is too small, the offset surface may be distorted where the reference mesh does not occur.
- If the reference mesh changes significantly near the model's boundary, offset surfaces may show unexpected changes. Offset surfaces are projected in the direction the reference mesh is going, and if the reference mesh changes direction just inside the boundary, that change will be reflected in the offset surface. This is normal if there is data that takes the reference mesh in a different direction, but if this is not desirable for the offset surface, consider making the geological model's boundary smaller.

The rest of this topic describes creating and working with an offset surface. It is divided into:

- [Creating an Offset Surface](#)
- [The Offset Surface in the Project Tree](#)
- [Refining an Offset Surface](#)
- [Changing Surfacing Options for an Offset Surface](#)
- [Changing Offset Limits](#)
- [Changing the Reference Mesh](#)
- [Editing the Reference Mesh](#)

Creating an Offset Surface

To start creating an offset surface, right-click on the **Surface Chronology** and select **New Deposit/Erosion > From Offset Surface**. The **New Offset Surface** window will appear:

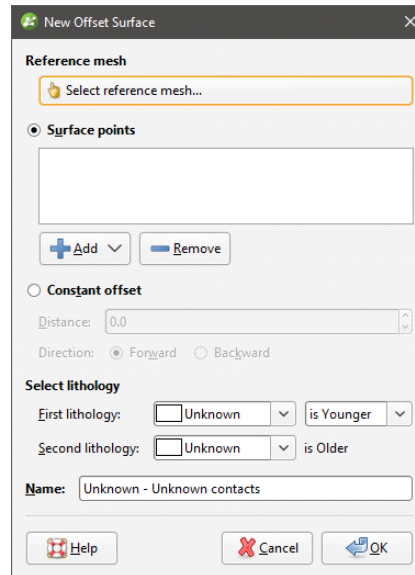

In the window that appears, you need to select a reference mesh, then either select **Surface points** to offset to or set a **Constant offset**.

Click **Select reference mesh** to view the meshes available in the project.

If you wish to offset from the reference mesh using a fixed distance, click **Constant offset** and set the **Distance**. For **Direction**, selecting **Forward** offsets the surface on the younger side of the reference mesh, and selecting **Backward** offsets on the older side.

If you wish to offset to points, click **Add**. You can offset to:

- Base lithology contacts or other lithology contacts in the project.
- Other data in the project. GIS data, points data and polylines can be used.

If you offset to points, you will be able to set additional options such as distance limits once the surface has been created. See [Changing Offset Limits](#) below for more information.

Select the **First Lithology** and **Second Lithology** from the lithologies defined for the model. If you have added base lithology contacts or other contacts to the surface, these will be set automatically from the data used.

Click **OK** to create the surface, which will appear in the project tree as part of the **Surface Chronology**.

The Offset Surface in the Project Tree

The name Leapfrog Geothermal automatically assigns to an offset surface is the lithologies assigned to each side of the surface. In the project tree, expand the surface to see how it was made:

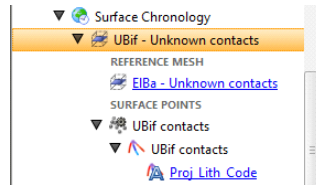

Double-click on the surface to edit it. Double-click on the contact points object (🌐) to edit the lithology and change compositing parameters.

As further refinements are made to the surface, that information will also be added to the project tree. See [Refining an Offset Surface](#) below for more information.

Refining an Offset Surface

You can refine an offset surface by:

- Adding other data. Right-click on the surface to see the options available, which will depend on how the surface was created. See [Adding Data to Surfaces](#) for more information.
- Editing the surface with a polyline. Right-click on the surface in the project tree and select either **Edit**. See [Editing Surfaces with Polylines](#) for more information.

It is not possible to add structural data or polylines with orientation information to an offset surface. If you edit an offset surface with a polyline, your options for editing the polyline will be limited.

To edit the surface's settings, double-click on it in the project tree. In the **Lithologies** tab, change the lithologies assigned to each side of the surface, if required.

You can swap the younging direction if the direction was assigned incorrectly when the surface was created. The change will be reflected in the scene. Note that changing the younging direction does not change which lithology is older or younger.

An offset surface can be created as a deposit or as an erosion. The difference between deposit and erosion contact surfaces is how they cut older lithologies, as described in [Contact Surfaces](#). For this reason, it is possible to change between the two types using the **Contact Type** setting.

An offset surface cannot be adjusted by applying a trend.

Changing Surfacing Options for an Offset Surface

Surfacing options for an offset surface can be changed by double-clicking on the surface in the project tree and then clicking on the **Surfacing** tab. There are additional settings related to

boundary filtering and snapping to data in the **Inputs** tab.

Boundary Filtering

When data objects are added to a surface, there are two ways to handle the data that lies outside the surface's boundary:

- **Filter the data.** The surface is only influenced by the data that falls inside the surface's boundary.
- **Leave the data unfiltered.** The surface is influenced by the data both inside and outside the surface's boundary.

The **Boundary filter** setting determines how data used to define the surface is filtered:

- **Off.** Data is not filtered.
- **All data.** All data is filtered.
- **Drilling only.** Only well data and data objects derived from well data are filtered.
- **Custom.** Only the data objects specified in the **Inputs** tab are filtered.

Snapping to Data

Often, surfaces should honour well data and treat data objects such as polylines and GIS data as interpretations, as discussed in [Honouring Surface Contacts](#).

There is a **Snap to data** setting for a geological model as a whole that is set in the **Geological Model > General** tab (see [Editing a Geological Model](#)). **Snap to data** can also be set on a surface-by-surface basis by double-clicking on the surface in the project tree and then clicking on the **Surfacing** tab.

For individual contact surfaces, the options are:

- **Inherit from GM.** The setting for the geological model as a whole is used. This is the default setting.
- **Off.** Surfaces do not snap to the data used to create them.
- **All data.** Surfaces snap to all data within the **Maximum snap distance**, which includes well data and any data added to the surfaces.
- **Drilling only.** Surfaces snap to well data and data objects derived from well data within the **Maximum snap distance** but not to other data used to modify the surfaces.
- **Custom.** Surfaces snap to the data objects indicated in the **Inputs** tab for each surface.

Take care in enabling snapping and in selecting what data the surface will snap to, as the more data you include, e.g. by setting a large **Maximum snap distance** or selecting **All data** for **Snap to data**, the greater the possibility that errors in the data or assumptions inherent in interpretations (e.g. polylines) will cause distortions in the meshes. If you do enable snapping, it is best to snap only to drilling data. See [Honouring Surface Contacts](#) for more information on these settings.

If you need a surface to honour well data but treat other data objects as interpretations, select **Drilling only**. To honour some data objects while treating others as interpretations, select **Custom**, then click on the **Inputs** tab to enable snapping for individual objects.

There is also a snap setting that can be used when offset limits are used. This option is discussed in [Changing Offset Limits](#) below.

Surface Resolution

The surface resolution for an offset surface can be inherited from the geological model or it can be set specifically for the surface. To change the surface resolution for an offset surface, double-click on the surface in the project tree and then click on the **Surfacing** tab. See [Surface Resolution for a Geological Model](#) for information about the surface resolution settings in the **Surfacing** tab.

Smoothing

The **Smoothing** parameter in the **Surfacing** tab can be used for all offset types other than **Constant**. If your reference surface is highly curved, you may see distortions in the offset surface. If this is the case, set **Smoothing** to a higher value.

Increasing the **Smoothing** parameter will generally result in faster processing when offsetting to large distances. If you are finding that processing time is excessively long for an offset surface, consider increasing **Smoothing**. In some situations, however, increasing **Smoothing** can exaggerate imperfections in the reference surface.

If you are offsetting by a small distance and processing is taking longer than expected, consider setting **Smoothing** to **None**.

Changing Offset Limits

There are four options for **Offset limits** in the **Surfacing** tab. Three relate to offsetting to points and the fourth to offsetting to a fixed distance from the reference mesh.

- The **None** option is the default setting used when a surface is created as an offset to points. No distance limits are used in creating the offset surface, and it simply follows the points used.
- The **Unidirectional limits** option allows you to set distance limits in one direction. Points outside the limits will be disregarded.
- The **Bidirectional limits** option allows you to set distance limits in both directions, and points outside these limits are disregarded. This setting is useful for modelling folded surfaces such as veins.
- The **Constant offset** option offsets the surface to a fixed distance from the reference mesh.

The **Forward** direction is the younger side of the reference mesh.

If the **Snap to data outside limits** setting is enabled, the surface will honour data, even if it is outside the distance limits. This option will be greyed out if **Snap to data** is off.

Changing to a Constant Offset

To use a constant offset rather than points, select the **Constant offset** option and set the **Distance** and **Direction** to offset the surface. Selecting **Forward** offsets the surface on the

younger side of the reference mesh, whereas selecting **Backward** offsets on the older side. If you created a surface as an offset to points and switch to using a constant offset, the points added to the surface when it was created will be disabled.

Changing to an Offset to Points

If you created an offset surface using a constant offset, you can change the surface to offset to points, but you must first add data to it. Do this by right-clicking on it in the project tree and selecting **Add**. Once you have added the data you wish to use, double-click on the surface and click on the **Surfacing** tab. Change the **Offset limits** option from **Constant offset** to one of the other three options.

Changing the Reference Mesh

To change the surface used as the reference mesh, click on the **Inputs** tab, then click on the reference mesh:

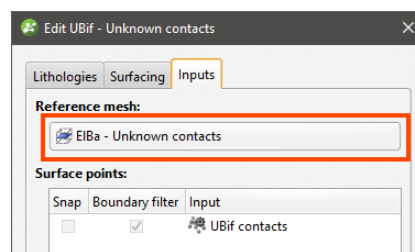

Select from the surfaces available in the project, keeping in mind the considerations discussed in [Changing the Reference Mesh](#).

Editing the Reference Mesh

You can also edit the reference mesh as you would other surfaces. All dependent offset surfaces will be updated as you make changes to the reference mesh.

Changing the younging direction of the reference mesh affects how offset surfaces are generated.

- For a constant offset surface, the younging direction of the reference mesh determines the forward and backward direction of the offset surface and, therefore, determines the location of the offset surface. Changing the younging direction of the reference mesh results in dependent offset surfaces changing location; the updated offset surface will be the mirror image of the original relative to the reference mesh.
- For surfaces offset to points, the location is determined by the points themselves. If the reference mesh's younging direction is changed, the offset surface's younging direction will also be flipped. The offset surface will still honour the contact data and will still appear at the same location relative to the reference mesh.

Structural Surfaces

A structural surface uses contact data and non-contact structural data to create a surface. A structural surface can interact with other volumes in the model as a deposit, an erosion or an

intrusion contact surface. The shape of the structural surface is suggested by the non-contact structural data used.

When creating a structural surface, there are two options for declustering the non-contact structural data:

- The input data is automatically declustered as part of creating the structural surface. There are no additional controls that determine how the data is declustered.
- Use a declustered structural data set as the non-contact input to the surface. This approach is recommended over the first approach as you can change how the data is declustered.

The rest of this topic describes how to create and work with a structural surface. It is divided into:

- [Creating a Structural Surface](#)
- [The Structural Surface in the Project Tree](#)
- [Refining a Structural Surface](#)
- [Surfacing Options for a Structural Surface](#)
- [Non-Contact Structural Inputs Settings](#)
- [Applying a Trend to a Structural Surface](#)
- [Value Clipping](#)

Creating a Structural Surface

To create a new structural surface, right-click on the **Surface Chronology** and select **New Structural Surface**. The **New Structural Surface** window will appear:

The screenshot shows the 'New Structural Surface' dialog box. It is organized into several sections:

- Select non-contact structural data:** A table with columns 'Structural Data', 'Query Filter', and 'Use Polarity'. Below the table are '+ Add' and '- Remove' buttons.
- Select other input data:** An empty list box with '+ Add' and '- Remove' buttons below it.
- Select lithologies:** Two rows of dropdown menus. The first row is 'First lithology: [Unknown] is Younger'. The second row is 'Second lithology: [Unknown] is Older'.
- Contact Type:** A dropdown menu set to 'Deposit'.
- Name:** A text field containing 'Unknown - Unknown contacts'.
- Buttons:** 'Help', 'Cancel', and 'OK' buttons at the bottom.

Use the **Add** buttons to add non-contact structural data and on-surface contacts, then set the **First lithology** and **Second lithology**. Other settings are:

- **Query Filter.** Select from the query filters defined for the selected structural data object.
- **Use Polarity.** Untick the box to use tangents only.
- **Contact Type.** Structural surfaces can be deposit, erosion or intrusion contacts. The same algorithm is used for each setting; the only difference is in how the surface interacts with other surfaces.

The Structural Surface in the Project Tree

The name Leapfrog Geothermal automatically assigns to a structural surface is the lithologies assigned to each side of the surface. In the project tree, expand the surface to see how it was made:

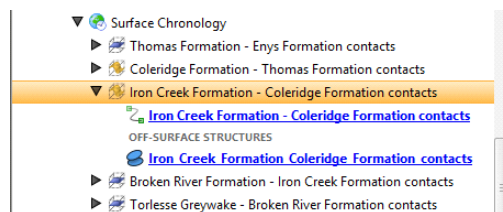

As further refinements are made to the surface, that information will also be added to the project tree. See [Refining a Structural Surface](#) below for more information.

To add more non-contact structural data to the surface, right-click on it in the project tree and select **Add > Structural Data**. In the window that appears, tick the box for **Non-contact Structural Data**:

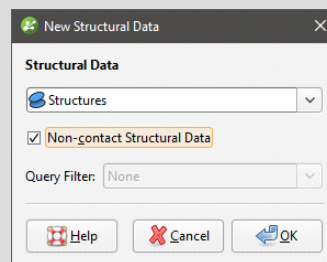

Refining a Structural Surface

You can refine structural surfaces in several ways:

- Add other data. Right-click on the surface to see the options available, which will depend on how the surface was created. See [Adding Data to Surfaces](#) for more information.
- Edit the surface with a polyline. Right-click on the surface in the project tree and select either **Edit > With Polyline**. See [Editing Surfaces with Polylines](#) for more information.
- Edit the surface using structural data. Right-click on the surface and select **Edit > With Structural Data**. See [Editing Surfaces with Structural Data](#) for more information.

To edit the surface's settings, double-click on it in the project tree. In the **Lithologies** tab, change the lithologies assigned to each side of the surface, if required.

You can swap the younging direction if the direction was assigned incorrectly when the surface was created. The change will be reflected in the scene. Note that changing the younging direction does not change which lithology is older or younger.

The **Contact Type** setting determines how the structural surface interacts with other lithologies, as described in [Contact Surfaces](#). A structural surface can be a deposit, erosion or intrusion contact surface.

For information on other techniques for refining structural surfaces, see [Surfacing Options for a Structural Surface](#) below.

Surfacing Options for a Structural Surface

Surfacing options for a structural surface are accessed by double-clicking on the surface in the project tree and clicking on the **Surfacing** tab. There are additional settings related to boundary filtering and snapping to data in the **Inputs** tab.

Setting the Surface Resolution

See [Surface Resolution for a Geological Model](#) for information about the surface resolution settings in the **Surfacing** tab.

Boundary Filtering

When data objects are added to a surface, there are two ways to handle the data that lies outside the surface's boundary:

- **Filter the data.** The surface is only influenced by the data that falls inside the surface's boundary.
- **Leave the data unfiltered.** The surface is influenced by the data both inside and outside the surface's boundary.

The boundary of a structural surface can be the geological model boundary or a fault block boundary.

The **Boundary filter** setting determines how data used to define the surface is filtered:

- **Off.** Data is not filtered.
- **All data.** All data is filtered.
- **Drilling only.** Only well data and data objects derived from well data are filtered.
- **Custom.** Only the data objects specified in the **Inputs** tab are filtered.

Snapping to Input Data

Often, surfaces should honour well data and treat data objects such as polylines and GIS data as interpretations. See [Honouring Surface Contacts](#).

There is a **Snap to data** setting for a geological model as a whole that is set in the **Geological Model > General** tab (see [Editing a Geological Model](#)). **Snap to data** can also be set on a

surface-by-surface basis by double-clicking on the surface in the project tree and then clicking on the **Surfacing** tab.

For individual contact surfaces, the options are:

- **Inherit from GM.** The setting for the geological model as a whole is used. This is the default setting.
- **Off.** Surfaces do not snap to the data used to create them.
- **All data.** Surfaces snap to all data within the **Maximum snap distance**, which includes well data and any data added to the surfaces.
- **Drilling only.** Surfaces snap to well data and data objects derived from well data within the **Maximum snap distance** but not to other data used to modify the surfaces.
- **Custom.** Surfaces snap to the data objects indicated in the **Inputs** tab for each surface.

Take care in enabling snapping and in selecting what data the surface will snap to, as the more data you include, e.g. by setting a large **Maximum snap distance** or selecting **All data** for **Snap to data**, the greater the possibility that errors in the data or assumptions inherent in interpretations (e.g. polylines) will cause distortions in the meshes. If you do enable snapping, it is best to snap only to drilling data. See [Honouring Surface Contacts](#) for more information on these settings.

If you need a surface to honour well data but treat other data objects as interpretations, select **Drilling only**. To honour some data objects while treating others as interpretations, select **Custom**, then click on the **Inputs** tab to enable snapping for individual objects.

Non-Contact Structural Inputs Settings

For the non-contact structural inputs, you can:

- Change the **Query Filter** setting. Select from the query filters defined for the selected structural data object.
- Change the **Use Polarity** setting. Untick the box to use tangents only.
- Change the **Boundary filter** setting, if the **Boundary filter** setting in the **Surfacing** tab is set to **Custom**.

Applying a Trend to a Structural Surface

There are two ways to change the trend for a structural surface:

- Right-click on the surface in the project tree and select **Adjust Surface**.
- Double-click on the surface in the project tree and then click on the **Trend** tab.

See [Global Trends](#) for more information.

Value Clipping

In the **Value Clipping** tab, you can manipulate the data distribution by clipping the data. Clipping caps values that are outside the range set by the **Lower bound** and **Upper bound** values. For example, if you change the **Upper bound** from 16.00 to 10.00, distance values above 10.00 will be regarded as 10.00.

When **Automatic clipping** and **Do clipping** are enabled, Leapfrog Geothermal sets the **Lower bound** and **Upper bound** from the data. To change the **Lower bound** and **Upper bound**, untick **Automatic clipping**, tick **Do clipping** and then change the values.

The Surface Chronology

When you create a contact surface, it appears in the project tree under the **Surface Chronology** object, but it is not enabled and, therefore, does not affect the geological model volumes. This means you can work on the surface without having to reprocess the model whenever you make a change to the surface. In Leapfrog Geothermal, you can easily define, enable and remove contact surfaces from a model, and you can experiment with modelling lithologies using different techniques in order to arrive at a geologically reasonable model.

To add a contact surface to the surface chronology, double-click on the **Surface Chronology** object. The **Surface Chronology** window will be displayed:

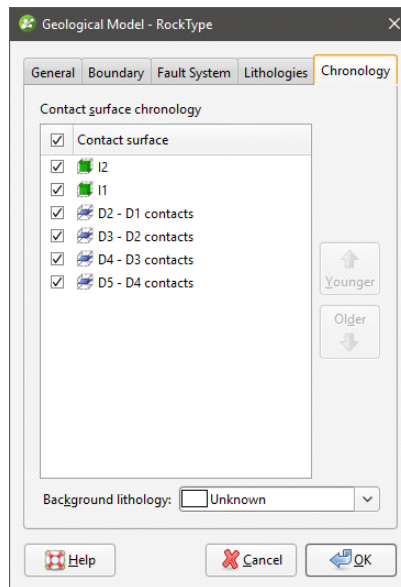

In the project tree, the surfaces are also arranged in chronological order:

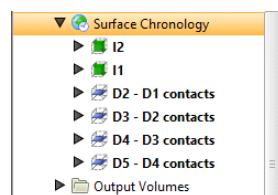

The **Surface Chronology** determines the overall chronological order of the contact surfaces in the model. If you build your models from the bottom up, you will find that often the contact surfaces are in the correct chronological order when you first open the **Surface Chronology** window. However, you can easily rearrange the chronology using the **Younger** and **Older** buttons. Tick the boxes for surfaces you wish to include in the model. When you click **OK**, the included surfaces will be used to subdivide the geological model into lithological volumes. The volumes will appear in the **Output Volumes** folder.

Output volumes are named according to the lithologies assigned to each side of the contact surfaces that bound each volume. If the lithology assigned to an output volume cannot be determined, it will be assigned the **Background lithology**.

If you are working with a faulted model and have defined the **Surface Chronology** for one fault block, you can copy the **Surface Chronology** to the empty fault blocks. See [Copying the Surface Chronology to an Empty Fault Block](#).

Refined Lithological Volumes

When you have built a geological model and want to model further within one of the volumes, you can do this by creating a refined geological model. This changes the way the original (parent) geological model is organised in the project tree and makes it possible to create a sub-model within one or more of the lithological volumes.

Before starting to refine lithological volumes, it is a good idea to make a copy of the original geological model.

To start refining a lithological volume, first create the refined geological model. To do this, right-click on the **Geological Models** folder and select **New Refined Model**:

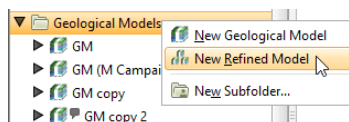

In the window that appears, select the geological model to refine and then select from its lithologies.

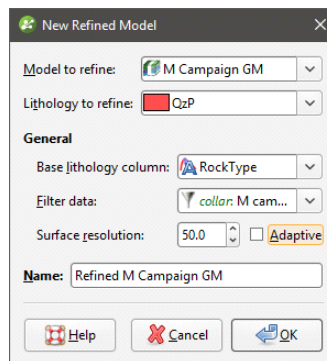

Next, set the **Base lithology column**, **Filter data** and **Surface resolution**. You cannot change the **Base lithology column** once the refined geological model has been established, but you will be able to change the resolution and data filter settings.

Click **OK** to create the refined lithology.

A new refined model (🏠) will be created in the project tree and the parent geological model will be moved into it. Here, a model called “M Campaign GM” has been used to create a new refined model, with the QzP volume selected as the refined lithology (🏠):

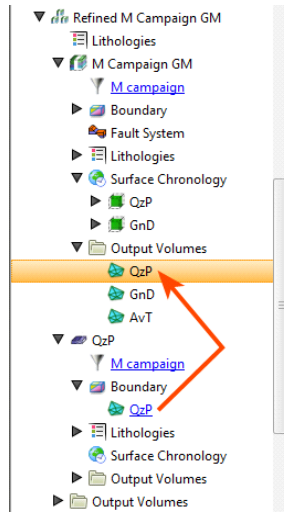

The sub-model (🏠) is created inside the refined geological model and has its own **Boundary**, **Lithologies**, **Surface Chronology** and **Output Volumes** objects.

You can work with the sub-model in the same manner you would a normal geological model. The exceptions are:

- The sub-model’s boundary cannot be refined directly. However, changes to the parent geological model will be updated in the sub-model’s boundary.
- The sub-model cannot have its own fault system. If the parent geological model is faulted, the sub-model will have its own fault blocks in which you can work.

See [Editing the Sub-Model](#) for information on refining the sub-model.

You can still work with the parent geological model in the usual manner. Any changes to the parent geological model that change the extents of the sub-model will be reflected in the sub-model’s boundary.

You can create additional sub-models by right-clicking on the refined model (🏠) and selecting **Refine Lithology**.

A sub-model can be viewed and evaluated in the same manner as normal geological models. However, sub-models cannot be used as layer guides for flow models.

Deleting the refined geological model deletes all models it contains. To return to the original project tree organisation for a geological model, delete the sub-models:

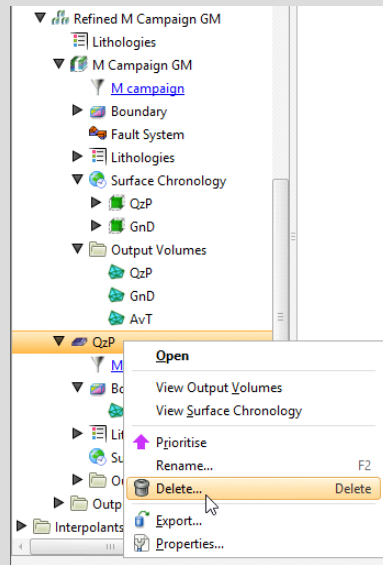

Once there are no more sub-models, the refined model object is also deleted, leaving the parent geological model.

The refined model has its own **Lithologies** table, which contains all the lithologies from the parent model and any sub-model lithologies. You cannot add lithologies to this table, but you can change the colours used to display them in the scene, as described in [Model Lithologies](#). To add more lithologies to a refined model, add them to the lithology table in either the sub-model or the parent geological model.

The refined model also has its own **Output Volumes** folder that combines information from the parent geological model and the sub-model. If no surfaces have been created in the sub-model, adding the refined model to the scene will simply display the volumes from the parent geological model. If surfaces have been created in the sub-model, then the volumes of the sub-model will be displayed alongside the volumes from the parent geological model.

Editing the Sub-Model

Work with the sub-model in the same manner described in [Editing a Geological Model](#). See [Contact Surfaces](#) and [The Surface Chronology](#).

The sub-model can have resolution settings that are different from those of the parent model. See [Surface Resolution in Leapfrog Geothermal](#) and [Surface Resolution for a Geological Model](#).

To change the lithology's resolution settings, double-click on the sub-model (📁) in the project tree. The **Geological Model** window appears:

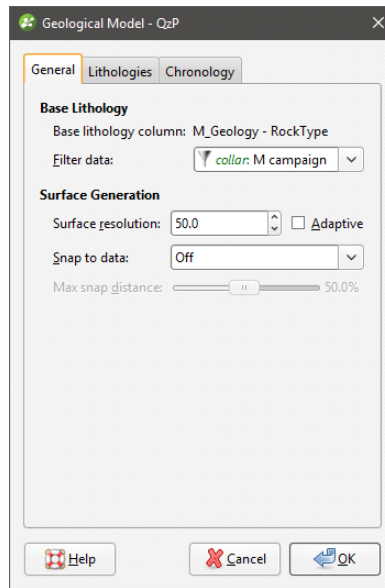

This window has only three tabs:

- There is no **Boundary** tab because the sub-model's boundary can only be modified by modifying the parent geological model.
- There is no **Fault System** tab because a sub-model cannot have its own fault system.

Numeric Models

The FastRBF algorithm employs interpolation functions to estimate values from known data. From these estimated values, geological surfaces are constructed as part of the model-building process.

With the **Numeric Models** folder, you can create numeric models and change their parameters.

- An RBF interpolant describes a physical quantity that varies continuously in space. An RBF interpolant can be used to model, for example, temperature distribution, with isosurfaces values set to represent different temperature ranges. See [RBF Interpolants](#).
- A multi-domained RBF interpolant is an RBF interpolant that has a number of individual sub-interpolants that are bounded by the fault blocks or output volumes of a selected geological model. Changes to all sub-interpolants can be made by editing the parent interpolant, while sub-interpolants can be edited to account for local influences on the values used, the trend and interpolation parameters. See [Multi-Domained RBF Interpolants](#).
- An indicator RBF interpolant calculates the likelihood that values will fall above and below a specific threshold. An indicator RBF interpolant can be used to produce a volume inside which further modelling is carried out. For example, you can create an indicator RBF interpolant for grade values above a certain threshold, and then use the inside volume as a lateral extent for another model. See [Indicator RBF Interpolants](#).
- A distance function calculates the distance to a set of points. As with an indicator RBF interpolant, a distance function is useful for restricting processing to a specific region. To do this, create a distance function, select the objects to use, then add at least one buffer. You can then use one of the distance function's isosurfaces as a lateral extent for another model. See [Distance Functions](#).
- An inverse distance weighted interpolant is useful in generating isosurfaces and volumes from larger datasets such as regular or semi-regular grids. See [Inverse Distance Weighted \(IDW\) Grid Interpolants](#).

Values that can be interpolated include downhole numeric data, composited well data and points data. See [Interpolant Functions](#) for a general introduction to interpolation.

The rest of this topic describes:

- [Importing a Variogram Model](#)
- [Copying a Numeric Model](#)
- [Creating a Static Copy of a Numeric Model](#)
- [Exporting Numeric Model Volumes and Surfaces](#)
- [Exporting Numeric Model Midpoints](#)

Importing a Variogram Model

Leapfrog Geothermal can import spheroidal variogram models exported from Snowden Supervisor. The settings that can be imported are:

- The anisotropy settings in the **Trend** tab
- The **Nugget**, **Total Sill**, **Base Range** and **Alpha** settings in the **Interpolant** tab

To import a variogram model, first create an interpolant. Next, right-click on the interpolant and select **Import Variogram Parameters**. In the window that appears, navigate to the folder that contains the XML file and select it. Click **Open**. The interpolant will be updated with the parameters in the XML file.

The imported variogram model overwrites the parameters in the interpolant, which cannot be undone. If you wish to save the original settings, make a copy of the interpolant before importing the new parameters.

Once the interpolant has been updated, you can edit it further by double-clicking on the interpolant in the project tree.

Copying a Numeric Model

Creating a copy of a numeric model is a useful way of experimenting with changes to a model.

To copy a numeric model, right-click on it in the project tree and select **Copy**. Enter a name for the copy of the model and click **OK**. The copy will be added to the project tree.

Creating a Static Copy of a Numeric Model

Creating a static copy preserves a snapshot of a numeric model that does not change, even when changes are made to the data on which the original model was dependent. This is a useful way of storing historical models and comparing models. Static copies can be exported from Leapfrog Geothermal, as described in [Exporting Numeric Model Volumes and Surfaces](#) below.

To create a static copy of a numeric model, right-click on it in the project tree and select **Static Copy**. Enter a name for the copy of the numeric model and click **OK**. The copy will be added to the **Numeric Models** folder.

The objects that make up a static copy of a numeric model depend on the type of model:

- For an RBF interpolant, a static copy is made up of a **Legend** object, a **Boundary** object, and all isosurfaces and output volumes created in building the model.
- For a multi-domained RBF interpolant, a static copy is made up of a **Legend** object, a **Boundary** object, and the output volumes created in building the model. There are also static copies of the sub-interpolants, which are the same as static copies of RBF interpolants.
- For an indicator RBF interpolant, a static copy is made up of a **Legend** object, a **Boundary** object, the model's isosurface and the output volumes.

Static models created in versions of Leapfrog Geothermal before 2.8 copied only the output volumes and the legend, and the static model appeared in the shape list only as a single line. When these static models are upgraded and displayed in the scene, the individual output volumes will be added to the shape list.

To view the date a static copy was created, right-click on it in the project tree and select **Properties**. The date the copy was created is in the **General** tab.

Exporting Numeric Model Volumes and Surfaces

There are three options for exporting a numeric model's output volumes and surfaces. These are:

- Export an output volume or a surface as a mesh. Right-click on it in the project tree and click **Export**. You will be prompted for a file name and location. See [Exporting a Single Mesh](#).
- Export an output volume as a thickness grid. Right-click on it in the project tree and click **Export Thickness Grid**. See [Thickness Grids](#).
- Export multiple output volumes and surfaces. Right-click on the interpolant in the project tree and select **Export**. See [Exporting Multiple Meshes from Models](#).

Exporting Numeric Model Midpoints

To export interval midpoints from a numeric model, right-click on the model's values object (📄) and select **Export**. Interval midpoints can be exported in the following formats:

- CSV text file (*.csv)
- DXF file (*.dxf)
- Snowden Supervisor CSV file (*.csv)
- Isatis 3D points file (*.asc)
- Drawing Files (2013/LT2013) (*.dwg)

The values exported are the midpoints of each segment, the X-Y-Z values and the hole ID. The Snowden Supervisor and Isatis 3D points formats also include the interval length, when the model has been created from well data.

In each case, you will be prompted for a filename and location.

You can extract interval midpoints from well data and then export them from the **Points** folder. See [Extracting Interval Midpoints from Well Data](#) for more information.

RBF Interpolants

If the data is both regularly and adequately sampled, different RBF interpolants will produce similar results. In practice, however, it is rarely the case that data is so abundant and input is

required to ensure an interpolant produces geologically reasonable results. For this reason, only a basic set of parameters are required when an RBF interpolant is first created. Once the interpolant has been created, you can refine it to factor in real-world observations and account for limitations in the data.

The rest of this topic describes how to create and modify RBF interpolants. It is divided into:

- [Creating an RBF Interpolant](#)
- [The RBF Interpolant in the Project Tree](#)
- [Interpolant Display](#)
- [RBF Interpolant Statistics](#)
- [Modifying an RBF Interpolant's Boundary with Lateral Extents](#)
- [Changing the Settings for an RBF Interpolant](#)

Creating an RBF Interpolant

To create an RBF interpolant, right-click on the **Numeric Models** folder and select **New RBF Interpolant**. The **New RBF Interpolant** window will be displayed:

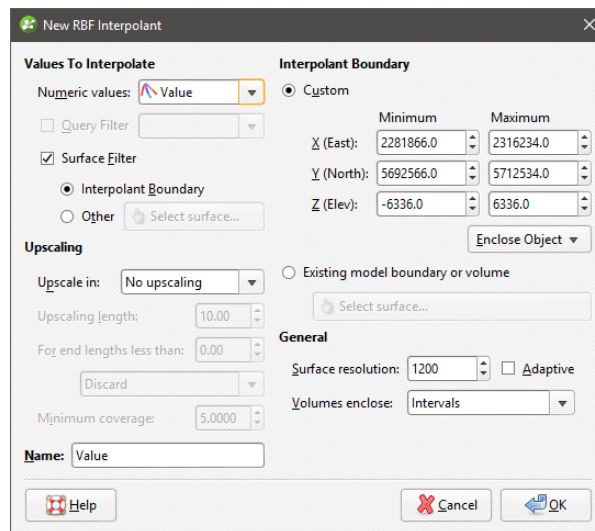

This window is divided into four parts that determine the values used to create the interpolant, the interpolant boundary, any compositing options and general interpolant properties.

If you are unsure of some settings, most can be changed later. However, the **Numeric values** object selected when the interpolant is created cannot be changed.

Values Used

In the **Values To Interpolate** part of the **New RBF Interpolant** window, you can select the values that will be used and choose whether or not to filter the data and use a subset of those values in the interpolant.

You can build an interpolant from either:

- Numeric data contained in imported well data.
- Points data imported into the **Points** folder.

All suitable data in the project is available from the **Numeric values** list.

Applying a Query Filter

If you have defined a query filter and wish to use it to create the interpolant, select the filter from the **Query filter** list. Once the interpolant has been created, you can remove the filter or select a different filter.

Applying a Surface Filter

All available data can be used to generate the interpolant or the data can be filtered so that only the data that is within the interpolant boundary or another boundary in the project influences the interpolant. The **Surface Filter** option is enabled by default, but if you wish to use all data in the project, untick the box for **Surface Filter**. Otherwise, you can select the **Interpolant Boundary** or another boundary in the project.

You can use both the **Query Filter** option and the **Surface Filter** option together.

The Interpolant Boundary

There are several ways to set the **Interpolant Boundary**:

- Enter values to set a **Custom** boundary.
- Use the controls in the scene to set the **Custom** boundary dimensions.
- Select another object in the project from the **Enclose Object** list, which could be the numeric values object being interpolated. The extents for that object will be used as the basis for the **Custom** boundary dimensions.
- Select another object in the project to use as the **Interpolant Boundary**. Click the **Existing model boundary or volume** option and select the required object from the list.

Once the interpolant has been created, you can further modify its boundary. See [Modifying an RBF Interpolant's Boundary with Lateral Extents](#) and [Adjusting the Interpolant Boundary](#) below.

Compositing Options

When numeric values from well data are used to create an interpolant, there are two approaches to compositing that data:

- Composite the well data, then use the composited values to create an interpolant. If you select composited values to create an interpolant, compositing options will be disabled.
- Use well data that hasn't been composited to create an interpolant, then apply compositing settings to the interpolated values. If you are interpolating values that have not been composited and do not have specific **Compositing** values in mind, you may wish to leave this option blank as it can be changed once the model has been created.

If you are interpolating points, compositing options will be disabled.

See [Numeric Composites](#) for more information on the effects of the **Compositing length**, **For end lengths less than** and **Minimum coverage** settings.

General Interpolant Properties

Set the **Surface resolution** for the interpolant and whether or not the resolution is adaptive. See [Surface Resolution in Leapfrog Geothermal](#) for more information on the effects of these settings. The resolution can be changed once the interpolant has been created, so setting a value in the **New RBF Interpolant** window is not vital. A lower value will produce more detail, but calculations will take longer.

The **Volumes enclose** option determines whether the interpolant volumes enclose **Higher Values**, **Lower Values** or **Intervals**. Again, this option can be changed once the interpolant has been created.

Enter a **Name** for the new interpolant and click **OK**.

Once you have created an RBF interpolant, you can adjust its properties by double-clicking on it. You can also double-click on the individual objects that make up the interpolant.

See also:

- [Copying a Numeric Model](#)
- [Creating a Static Copy of a Numeric Model](#)
- [Exporting Numeric Model Volumes and Surfaces](#)

The RBF Interpolant in the Project Tree

The new interpolant will be created and added to the **Numeric Models** folder. The new interpolant contains objects that represent different parts of the interpolant:

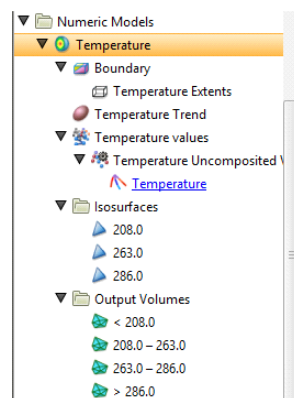

- The **Boundary** object defines the limits of the interpolant. See [Adjusting the Interpolant Boundary](#).
- The **Trend** object describes the trend applied in the interpolant. See [Changing the Trend for an RBF Interpolant](#).
- The points data values object contains all the data used in generating the interpolant. See [Adjusting the Values Used](#).

- The **Isosurfaces** folder contains all the meshes generated in building the interpolant.
- The **Output Volumes** folder contains all the volumes generated in building the interpolant.

Other objects may appear in the project tree under the interpolant as you make changes to it.

Interpolant Display

Display the interpolant by:

- Dragging the interpolant into the scene or right-clicking on the interpolant and selecting **View Output Volumes**. Both actions display the interpolant's output volumes.
- Right-clicking on the interpolant and selecting **View Isosurfaces**.

RBF Interpolant Statistics

You can view the approximated mean for each output volume by right-clicking on the interpolant and selecting **Properties**. Click on the **Statistics** tab:

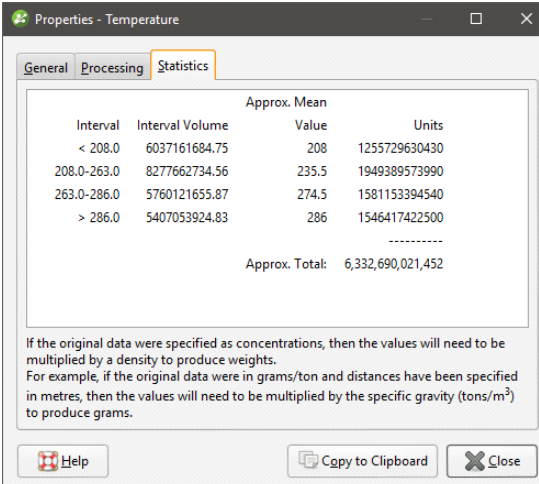

Approx. Mean			
Interval	Interval Volume	Value	Units
< 208.0	6037161684.75	208	1255729630430
208.0-263.0	8277662734.56	235.5	1949389573990
263.0-286.0	5760121655.87	274.5	1581153394540
> 286.0	5407053924.83	286	1546417422500
Approx. Total:			6,332,690,021,452

If the original data were specified as concentrations, then the values will need to be multiplied by a density to produce weights.
For example, if the original data were in grams/ton and distances have been specified in metres, then the values will need to be multiplied by the specific gravity (tons/m³) to produce grams.

You can copy the information displayed in the **Statistics** tab to the clipboard for use in other applications.

Modifying an RBF Interpolant's Boundary with Lateral Extents

RBF interpolants are created with a basic set of rectangular extents that can then be refined using other data in the project. These extents usually correspond to the ground surface and known boundaries. Creating extents can also be used to restrict modelling to a particular area of interest; for example, modelling can be restricted to a known distance from wells by applying a distance function as a lateral extent. Extents do not need to be strictly vertical surfaces and can be model volumes.

Creating Lateral Extents

To create an extent, expand the RBF interpolant in the project tree. Right-click on the **Boundary** object and select from the **New Lateral Extent** options. Follow the prompts to create the extent, which will then appear in the project tree under the interpolant's **Boundary** object.

New extents are automatically applied to the boundary being modified. Leapfrog Geothermal usually orients a new extent correctly, with red presenting the inside face of the extent and blue representing the outside face. If this is not the case, you can change the orientation by right-clicking on the extent in the project tree and selecting **Swap Inside**.

Extent from a Polyline

You can create an extent from a polyline that already exists in the project or you can draw a new one. If you want to use an imported polyline, import it into the **Polylines** folder before creating the new extent.

To create a new extent from a polyline, right-click on the interpolant's **Boundary** object and select **New Lateral Extent > From Polyline**. In the window that appears, select whether you will create a new polyline or use an existing one:

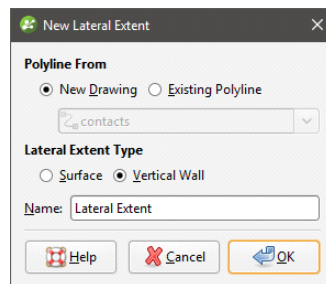

You can create the extent as a **Vertical Wall** or **Surface**. If you create the lateral extent as a **Surface**, you will be able to modify it using additional data, as described below. A lateral extent created as a **Vertical Wall**, however, cannot be modified.

Click **OK** to generate the new extent. If you have chosen to create a **New Drawing**, the drawing controls will appear in the scene and you can begin drawing, as described in [Drawing in the Scene](#).

The new extent will appear in the project tree as part of the **Boundary** object.

If the surface generated does not fit the polyline adequately, you can increase the quality of the fit by adding more points to the polyline. See [Drawing in the Scene](#) for information on adding points to polylines.

Extents created from polylines can be modified by adding points data, GIS vector data and structural data. You can also add polylines and structural data to the extent. See [Adding Data to an Extent](#), [Editing an Extent with a Polyline](#) and [Editing an Extent with Structural Data](#) for more information.

Extent from GIS Vector Data

GIS data in the project can be used to create a lateral extent for an RBF interpolant. Once the data you wish to use has been imported into the project, right-click on the interpolant's **Boundary** object and select **New Lateral Extent > From GIS Vector Data**.

In the window that appears, select the data object you wish to use:

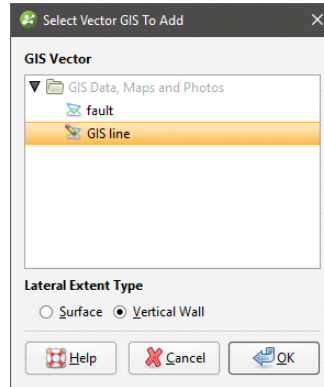

You can create the extent as a **Vertical Wall** or **Surface**. If you create the lateral extent as a **Surface**, you will be able to modify it using additional data, as described below. A lateral extent created as a **Vertical Wall**, however, cannot be modified.

If you select the **Surface** option, you can use the GIS data object with its own elevation data or projected onto the topography:

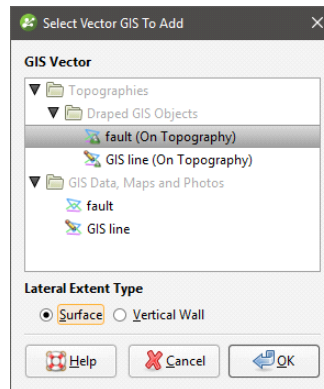

Using the **On Topography** option makes sense for GIS data as it is, by nature, on the topography. The **On Topography** option also mitigates any issues that may occur if elevation information in the GIS data object conflicts with that in the project.

Click **OK** to create the new extent. The new extent will appear in the project tree as part of the **Boundary** object.

Extents created from GIS data can be modified by adding points data, GIS vector data and structural data. You can also add polylines and structural data to the extent. See [Adding Data to an Extent](#), [Editing an Extent with a Polyline](#) and [Editing an Extent with Structural Data](#) for more information.

Extent from Points

To create a new extent from points data, right-click on the interpolant's **Boundary** object and select **New Lateral Extent > From Points**. The **Select Points To Add** window will be displayed, showing points data available in the project:

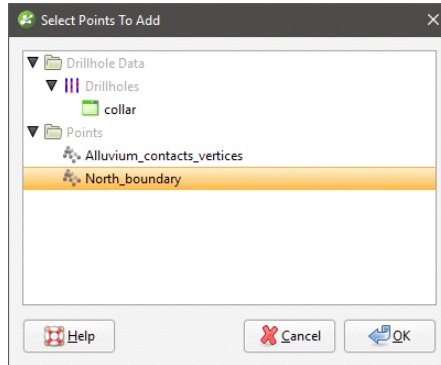

Select the information you wish to use and click **OK**.

The new extent will appear in the project tree as part of the **Boundary** object.

Extents created from points can be modified by adding points data, GIS vector data and structural data. You can also add polylines and structural data to the extent. See [Adding Data to an Extent](#), [Editing an Extent with a Polyline](#) and [Editing an Extent with Structural Data](#) for more information.

Extent from Structural Data

Planar structural data can be used to create a lateral extent for an RBF interpolant. You can create a new structural data table or use a table that already exists in the project. If you want to use categories of structural data in creating the extent, use an existing table and create filters for those categories before creating the lateral extent.

To start, right-click on the interpolant's **Boundary** object and select **New Lateral Extent > From Structural Data**. The **New Structural Data** window will be displayed, showing structural data available in the project:

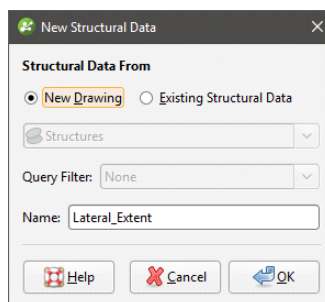

Select the **New Drawing** option to draw the structural data points directly in the scene.

Select the **Existing Structural Data** option to use a table in the **Structural Modelling** folder. With this option, you will be able to select from the categories available in the data table, if query filters have been created for those categories:

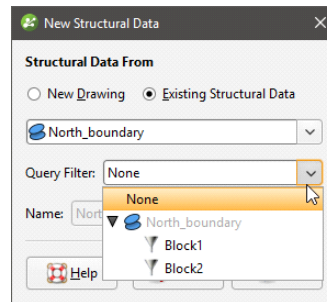

Click **OK** to generate the new extent. If you have chosen to create a **New Drawing**, the drawing controls will appear in the scene and you can begin drawing, as described in [Creating New Planar Structural Data Tables](#). To share the new structural data table, right-click on it and select **Share**. The table will be saved to the **Structural Modelling** folder.

The new extent will appear in the project tree as part of the **Boundary** object.

Extents created from structural data can be modified by adding points data, GIS vector data and structural data. You can also add polylines and structural data to the extent. See [Adding Data to an Extent](#), [Editing an Extent with a Polyline](#) and [Editing an Extent with Structural Data](#) for more information.

Extent from a Surface

To use a surface as lateral extent for an RBF interpolant, right-click on the interpolant's **Boundary** object and select **New Lateral Extent > From Surface**. The **Select Boundary** window will appear, showing all the meshes that can be used as an extent:

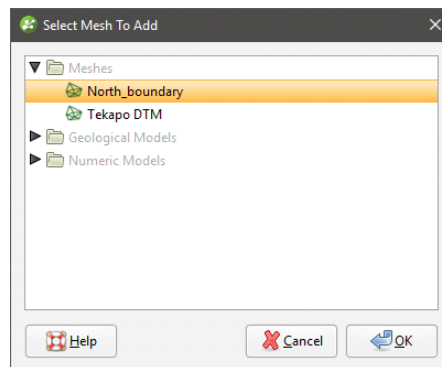

Select the required mesh and click **OK**. The extent will be added to the interpolant's **Boundary** object.

You cannot modify an extent created from a mesh by adding data, editing with polylines or structural data or by applying a trend. However, the extent is linked to the mesh used to create it, and updating the mesh will update the extent.

Extent from Distance to Points

Leapfrog Geothermal can calculate the distance to set of points and use the resulting distance buffer as a lateral extent for an RBF interpolant. To create a new lateral extent from a distance

buffer, right-click on the interpolant's **Boundary** object and select **New Lateral Extent > From Distance To Points**. The **Smoothed Distance Buffer** window will appear:

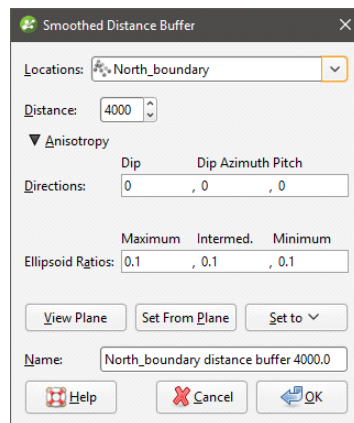

Select the **Distance** and set an **Anisotropy**, if required.

The **Ellipsoid Ratios** determine the relative shape and strength of the ellipsoids in the scene, where:

- The **Maximum** value is the relative strength in the direction of the green line on the moving plane.
- The **Intermed.** value is the relative strength in the direction perpendicular to the green line on the moving plane.
- The **Minimum** value is the relative strength in the direction orthogonal to the plane.

You can also use the **Set to** list to choose different options Leapfrog Geothermal has generated based on the data used to build the interpolant. **Isotropic** is the default option used when the interpolant is created.

Click **OK** to create the new extent, which will appear in the project tree as part of the **Boundary** object.

To change the extent's settings, expand the interpolant's **Boundary** object in the project tree and double-click on the extent. Adjust the **Distance** and **Anisotropy**, if required.

Extents created from a distance to points function can be modified by adding points data and GIS vector data. See [Adding Data to an Extent](#).

Extent from a Distance Function

A distance function calculates the distance to a set of points and can be used to bound an RBF interpolant. You can use an existing distance function as a lateral extent or create a new one.

To use a distance function as a lateral extent, right-click on the interpolant's **Boundary** and select **New Lateral Extent > From Distance Function**. If there are no distance functions in the project, you will be prompted to create a new one. See [Distance Functions](#) for information on defining and editing the distance function.

When there are already distance functions in the project, you will be prompted to choose between creating a new function or using an existing one:

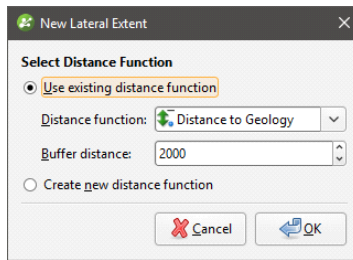

To use an existing function, select it from the list and set a **Buffer distance**. Click **OK** to create the lateral extent.

When you create a new distance function, it will be part of the interpolant's **Boundary** object and will not be available elsewhere in the project. To share it within the project, expand the lateral extent in the project tree and right-click on the distance function. Select **Share**. The distance function will be saved to the **Numeric Models** folder.

To change the extent's settings, expand the interpolant's **Boundary** object in the project tree and double-click on the extent. Adjust the **Distance** and **Anisotropy**, if required.

Changing a Lateral Extent's Settings

For lateral extents created from from polylines, GIS data, points and structural data, you can change the extent's settings by double-clicking on it in the project tree.

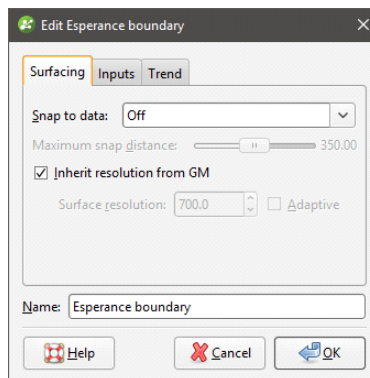

In the **Surfacing** tab, you can change surface resolution and contact honouring options, which are described below. In the **Trend** tab, you can apply a trend to the extent, which is described in [Applying a Trend](#).

Surface Resolution

For RBF interpolants, the resolution of lateral extents is inherited from the settings in the interpolant's **Outputs** tab, but the adaptive isosurfer is automatically disabled. Enter a different **Surface resolution** value, if required, and tick **Adaptive** to enable the adaptive isosurfer.

Contact Honouring

Often, surfaces should honour well data and treat data objects such as polylines and GIS data as interpretations. For extents, the **Snap to data** setting in the **Surfacing** tab determines

whether or not the extent honours the data used to create it. Options are:

- **Off.** The extent does not snap to the data used to create it. This is the default setting.
- **All data.** The extent snaps to all data within the **Maximum snap distance**, which includes well data and any data added to the extent.
- **Drilling only.** The extent snaps to well data and data objects derived from well data within the **Maximum snap distance**, but not to other data used to modify the extent. For example, the extent will honour points data derived from well data, but not points data imported into the **Points** folder.
- **Custom.** The extent snaps to the data objects indicated in the **Inputs** tab that are within the **Maximum snap distance**.

Take care in enabling snapping and in selecting what data the surface will snap to, as the more data you include, e.g. by setting a large **Maximum snap distance** or selecting **All data** for **Snap to data**, the greater the possibility that errors in the data or assumptions inherent in interpretations (e.g. polylines) will cause distortions in the meshes. If you do enable snapping, it is best to snap only to drilling data. See [Honouring Surface Contacts](#) for more information on these settings.

Whatever the setting, you can see what objects are snapped to by clicking on the **Inputs** tab.

If you need the extent to honour well data but treat other data objects as interpretations, select **Drilling only**. To honour some data objects while treating others as interpretations, select **Custom**, then click on the **Inputs** tab to enable snapping for individual objects.

Applying a Trend

You can adjust an extent created from polylines, GIS data, points and structural data by applying a trend to it. To do this, add the extent to the scene. Next, double-click on the extent in the project tree and click the **Trend** tab.

Often the easiest way to apply a trend is to click on the **Draw plane line** button  and draw a plane line in the scene in the direction in which you wish to adjust the surface. You may need to rotate the scene to see the plane properly.

The **Ellipsoid Ratios** determine the relative shape and strength of the ellipsoids in the scene, where:

- The **Maximum** value is the relative strength in the direction of the green line on the moving plane.
- The **Intermed.** value is the relative strength in the direction perpendicular to the green line on the moving plane.
- The **Minimum** value is the relative strength in the direction orthogonal to the plane.

Once you have adjusted the plane to represent the trend you wish to use, click the **Set From Plane** button to copy the moving plane settings.

The **Set to** list contains a number of different options Leapfrog Geothermal has generated based on the data used in the project. **Isotropic** is the default option used when the extent was created. Settings made to other surfaces in the project will also be listed, which makes it easy to apply the same settings to many surfaces.

Click **OK** to apply the changes.

See [Global Trends](#) for more information.

Adding Data to an Extent

Extents created from polylines, GIS data, points and structural data can be modified by adding points data objects, GIS vector data and structural data. Extents created from a distance to points function can be modified by adding points data and GIS vector data. To add data to an extent, right-click on the extent in the project tree and select the data type you wish to use from the **Add** menu.

- Points data. Select from the points data objects available in the project and click **OK**.
- GIS vector data. Select from the GIS vector data available in the project and click **OK**.
- Structural data. Select from the structural data tables available in the project. If the selected table has query filters defined, you can apply one of these filters by ticking **Use query filter** and then selecting the required filter from the list. Click **OK** to add the selected data to the extent. An alternative to adding an existing structural data table to an extent is to edit the extent with structural data. This is described in [Editing an Extent with Structural Data](#) below.

You can also add a polyline that already exists in the project. To do this, right-click on the extent in the project tree and select **Add > Polyline**. You will be prompted to choose from the polylines in the **Polylines** folder.

Editing an Extent with a Polyline

You can edit an extent using a polyline, which is described in [Editing Surfaces with Polylines](#). A polyline used to edit an extent will be added to the project tree as part of the extent. To edit the polyline, right-click on it and select **Edit Polyline** or add it to the scene and click the **Edit** button () in the shape list. If you wish to remove the polyline from the extent, right-click on it in the project tree and select **Delete** or **Remove**.

To add an existing polyline to a lateral extent, use the **Add > Polyline** option.

Editing an Extent with Structural Data

You can edit an extent using structural data, which is described in [Editing Surfaces with Structural Data](#). A structural data table will be added to the project tree as part of the extent. To edit the table, right-click on it and select **Edit In Scene** or add it to the scene and click the **Edit** button () in the shape list. If you wish to remove the table from the extent, right-click on it in the project tree and select **Delete** or **Remove**.

Removing an Extent from an Interpolant

If you have defined an extent and want to remove it from the interpolant, there are two options. The first is to right-click on the extent in the project tree and click **Delete**. This deletes the extent from the interpolant, but does not delete parent objects from the project unless they were

created as part of the interpolant, e.g. a polyline used as a lateral extent but not shared within the project. Use this option only if you are sure you do not want to use the extent.

The second method is useful if you are making changes to the extent and do not want to recompute the interpolant with each change. Double-click on the interpolant's **Boundary** object or double-click on the interpolant and click on the **Boundary** tab. The **Boundaries** part of the window lists all objects used as extents for the interpolant. Untick the box for extents to temporarily disable them in the interpolant. The interpolant will be reprocessed, but you can then work on the extent without reprocessing the interpolant. Disabled extents will be marked as inactive in the project tree.

Changing the Settings for an RBF Interpolant

To change the settings for an RBF interpolant, you can either double-click on the interpolant in the **Numeric Models** folder or right-click and select **Open**. When creating an RBF interpolant, only a basic set of parameters is used. The **Edit RBF Interpolant** window provides finer controls over these basic parameters so you can refine the interpolant to factor in real-world observations and account for limitations in the data.

For a multi-domained RBF interpolant, these parameters can be changed for the parent interpolant, and the trend, clipping, transformation and interpolation settings can be changed for the sub-interpolants.

Adjusting the Values Used

The **Values** tab in the **Edit Interpolant** window shows the values used in creating the interpolant and provides options for filtering the data. Although you cannot change the values used to create an interpolant, you can filter the values using the **Query filter** and **Surface filter** options.

You can adjust the values using a contour polyline or by adding points. Both options are available by expanding the interpolant in the project tree, then right-clicking on the values object:

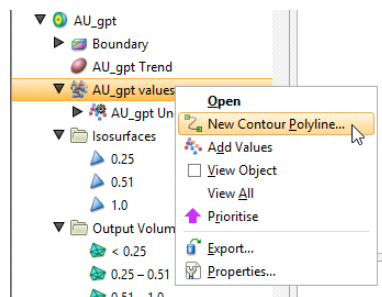

These options are described below in [Adding a Contour Polyline](#) and [Adding Points](#).

To apply a query filter, tick the **Query filter** box in the **Values** tab and select the available queries from the list.

To change the object used as the **Surface filter**, select the required object from the list. Note that the list contains an object that defines the interpolant's own boundary, which can be adjusted in the **Boundary** tab.

Adding a Contour Polyline

Adding a contour polyline is a useful tool for manually adjusting a surface to make it more geologically reasonable. To start adding a contour polyline, draw a slice where you wish to adjust the surface and decide what value you will assign to the contour line. Next, right-click on the values object and select **New Contour Polyline**. The next step is to choose whether you will draw a new polyline or use one already in the project:

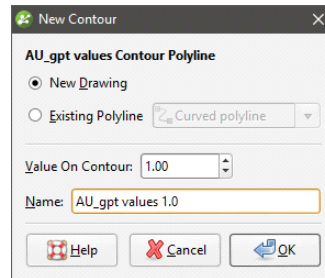

Only GIS lines, polylines imported into Leapfrog Geothermal or polylines created using the straight line drawing tool can be used to create contour lines.

Enter the value to be used for the contour and a name for it. Click **OK**. If you have chosen the **New Drawing** option, the new object will be created in the project tree and drawing tools will appear in the scene. Start drawing in the scene as described in [Drawing in the Scene](#). When you have finished drawing, click the **Save** button (💾). The new contour will automatically be added to the interpolant and will appear in the project tree as part of the interpolant’s values object.

To change the value assigned to a contour polyline, double-click on the interpolant in the project tree. In the **Values** tab, contour polylines and their assigned values are shown in the **User contour values** table:

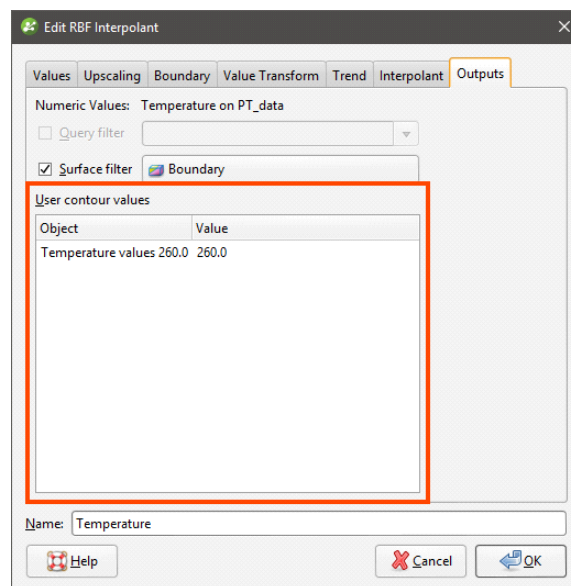

To change the value on a contour, click in the **Value** column and edit the entry.

To edit the polyline, right-click on it in the project tree and select **Edit Polyline** or add it to the scene and click the **Edit** button (✎) in the shape list. If you wish to remove a contour polyline

from the interpolant, right-click on it in the project tree and select **Delete** or **Remove**.

Adding Points

To add points to an RBF interpolant, right-click on the values object in the project tree and select **Add Values**. Leapfrog Geothermal will display a list of all suitable points objects in the project. Select an object and click **OK**.

A hyperlink to the points object will be added to the values object in the project tree. To remove the points object, right-click on the points object and select **Remove**.

Compositing Parameters for an RBF Interpolant

When an RBF interpolant has been created from data that has not been composited, compositing parameters can be changed by double-clicking on the interpolant in the project tree, then clicking on the **Compositing** tab.

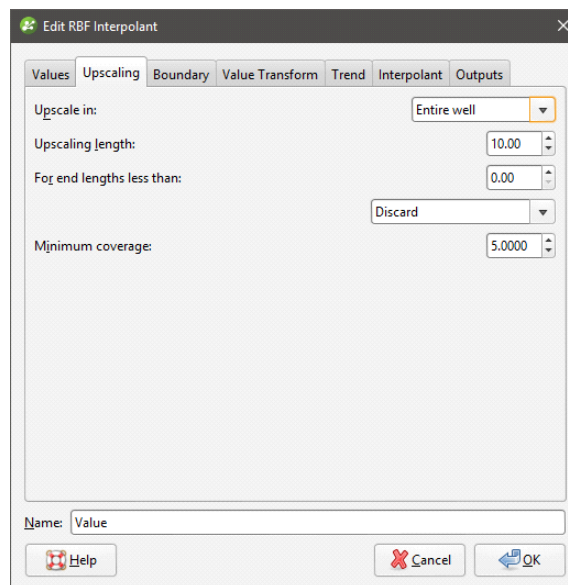

The **Compositing** tab will only appear for interpolants created from well data that has not been composited.

You can composite in the entire well or only where the data falls inside the interpolant boundary. See [Numeric Composites](#) for more information on the effects of the **Compositing length**, **For end lengths less than** and **Minimum coverage** settings.

Adjusting the Interpolant Boundary

See [Modifying an RBF Interpolant's Boundary with Lateral Extents](#) above for information on creating and working with lateral extents.

To change an RBF interpolant's boundary, double-click on the interpolant in the project tree, then click on the **Boundary** tab:

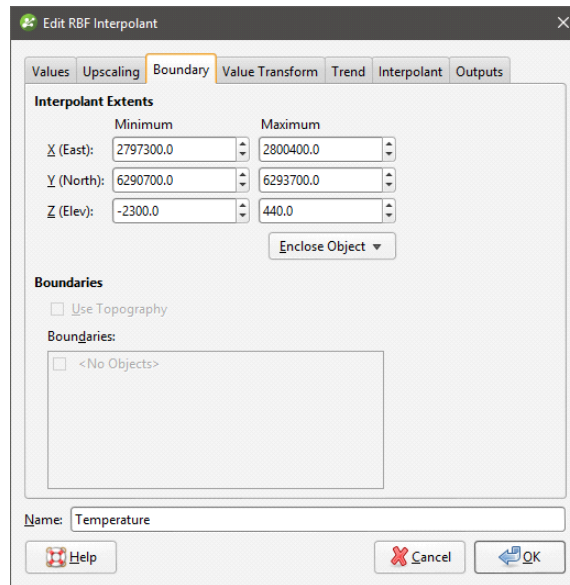

Controls to adjust the boundary will also appear in the scene.

Tick the **Use Topography** box to use the topography as a boundary. The topography is normally not used as a boundary for interpolants and so this option is disabled when an interpolant is first created.

The **Boundaries** list shows objects that have been used to modify the boundary. You can disable any of these lateral extents by unticking the box.

Lateral extents can be used to restrict modelling to a particular area of interest; for example, modelling can be restricted to a known distance from wells by applying a distance function as a lateral extent.

Clipping and Transforming Values for an RBF Interpolant

To clip data and apply a transformation to an RBF interpolant, double-click on the interpolant in the project tree, then click on the **Value Transform** tab:

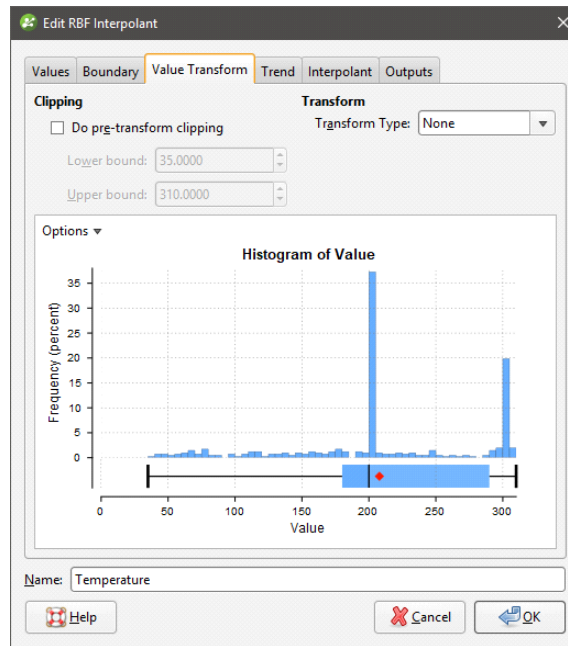

The options for **Transform Type** are **None** and **Log**. **Log** uses a natural logarithm to compress the data values to a smaller range. This may be useful if the data range spans orders of magnitude. The function used is:

$$\ln(x+s)+c$$

where s is the **Pre-log shift** and c is a constant. In order to avoid issues with taking the logarithm of zero or a negative number, **Pre-log shift** is a constant added to make the minimum value positive. The value of the pre-log shift will automatically be chosen to add to the minimum value in the data set to raise it to 0.001. This constant is then added to all the data samples. You can modify the value of the **Pre-log shift**, as increasing this value further away from zero can be used to reduce the effect of the natural logarithm transformation on the resultant isosurfaces.

Note that a further constant, c , is added to the natural logarithm of the data with the pre-log shift added to it. If there are any negative numbers that result from taking the natural log of the data, the absolute value of the most negative number is taken and added to all the transformed data results. This will raise the value of all the data so the minimum data value is zero. The value of c is chosen automatically and cannot be modified.

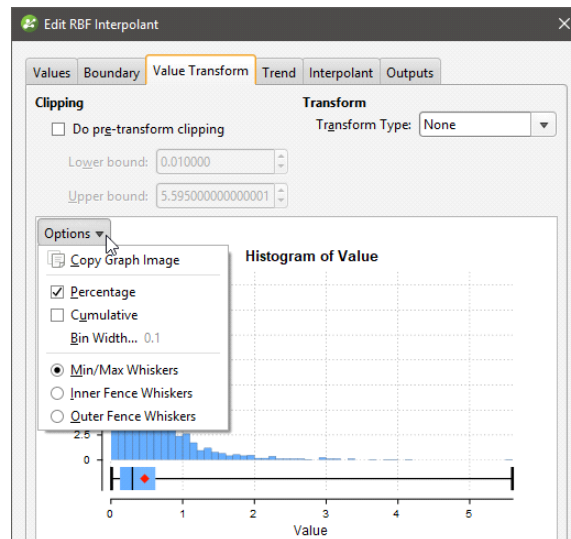

Click on the **Options** button to change the histogram's display, including the **Bin Width**.

If you tick the **Do pre-transform clipping** option, you can set the **Lower bound** and the **Upper bound** to cap values that are too low or too high. For example, if you set the **Upper bound** from 14.00 to 10.00, grade values above 10.00 will be regarded as 10.00.

Changing the Trend for an RBF Interpolant

You can apply a global trend or a structural trend to an RBF interpolant. To do this, add the interpolant to the scene, then double-click on the interpolant in the project tree. Click on the **Trend** tab in the **Edit RBF Interpolant** window.

See:

- [Using a Global Trend](#)
- [Using a Structural Trend](#)

Using a Global Trend

The easiest way to change the trend applied to an interpolant is using a global trend set from the moving plane.

Click **View Plane** to add the moving plane to the scene, then click on the plane to view its controls. You may need to hide part of the interpolant to click on the moving plane:

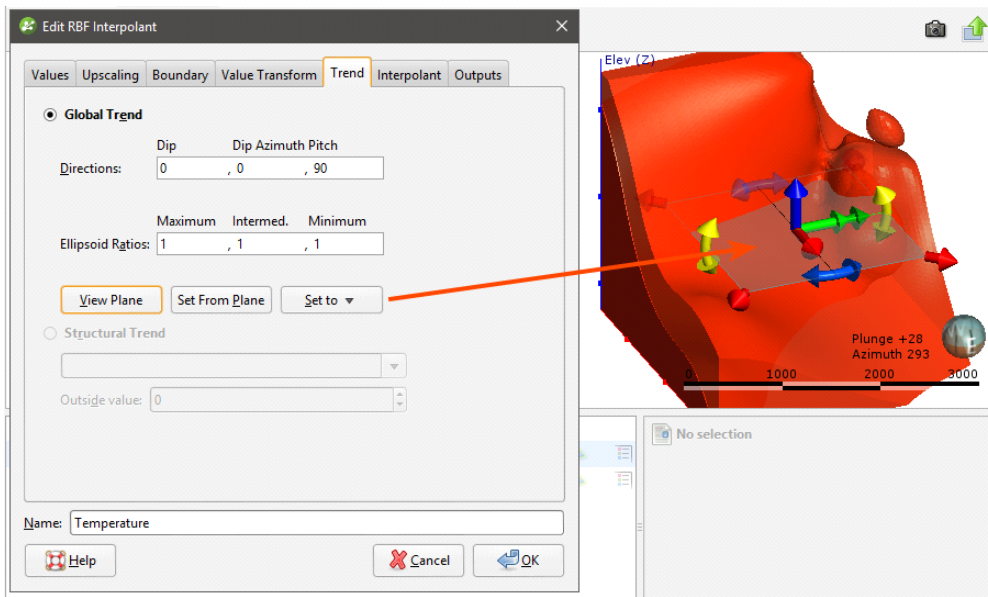

You can also use the **Set to** list to choose different options Leapfrog Geothermal has generated based on the data used to build the interpolant. **Isotropic** is the default option used when the interpolant is created.

The **Ellipsoid Ratios** determine the relative shape and strength of the ellipsoids in the scene, where:

- The **Maximum** value is the relative strength in the direction of the green line on the moving plane.
- The **Intermed.** value is the relative strength in the direction perpendicular to the green line on the moving plane.
- The **Minimum** value is the relative strength in the direction orthogonal to the plane.

Click **OK** to regenerate the interpolant and view changes.

Using a Structural Trend

You can also set the trend for an RBF interpolant from a structural trend. First, you must create or import the required mesh and create a structural trend. See [Structural Trends](#) for more information.

Once the structural trend has been created, add it to the interpolant by double-clicking on the interpolant in the project tree, then clicking on the **Trend** tab. Select the **Structural Trend** option, then select the required trend from the list:

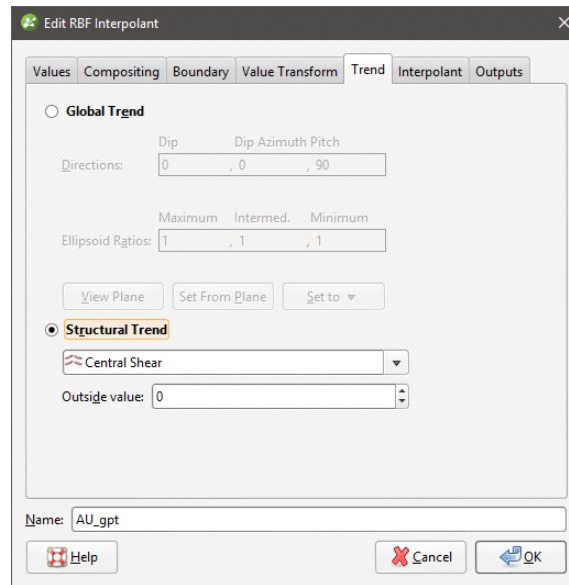

Click **OK**. The trend will be added to the interpolant and will appear as part of the interpolant, as shown:

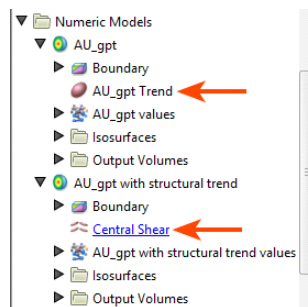

When you apply a structural trend, you cannot use the **Linear** interpolant. See [Interpolant Functions](#) for more information.

Once a structural trend has been defined for the interpolant, you can edit it by clicking on the trend hyperlink in the project tree, then opening the structural trend applied to the interpolant. The **Structural Trend** window will appear. See [Structural Trends](#) for information on the settings in this screen.

The structural trend information included as part of the interpolant is a link to the original structural trend. When you change the structural trend that is part of the interpolant, the changes are also made for the original structural trend.

When a structural trend that is **Strongest along meshes** or **Blending** is used, the interpolant will regress to the global mean trend away from the meshes. The global trend that will be used is set in the **Global Trend** tab for the structural trend.

Adjusting Interpolation Parameters

To adjust interpolation parameters for an RBF interpolant, double-click on the interpolant in the project tree, then click on the **Interpolant** tab:

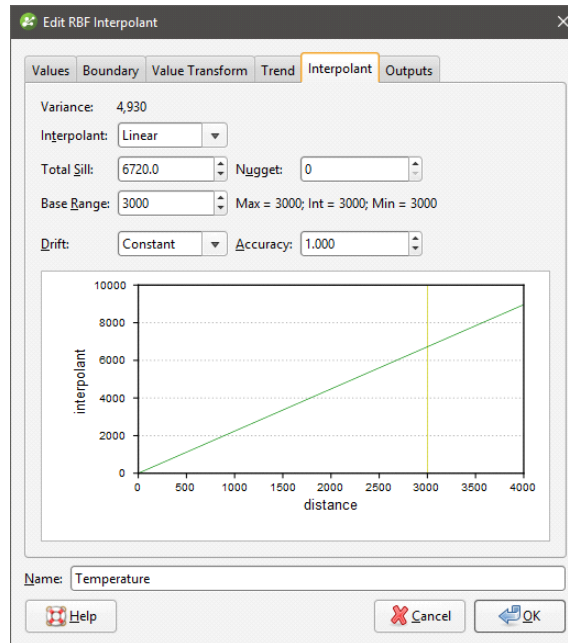

Two models are available, the spheroidal interpolant and the linear interpolant. See [The Spheroidal Interpolant Function](#) and [The Linear Interpolant Function](#) for more information on the settings in this tab.

Output Settings for an RBF Interpolant

You can change the parameters used to generate RBF interpolant outputs by double-clicking on the interpolant, then clicking on the **Outputs** tab.

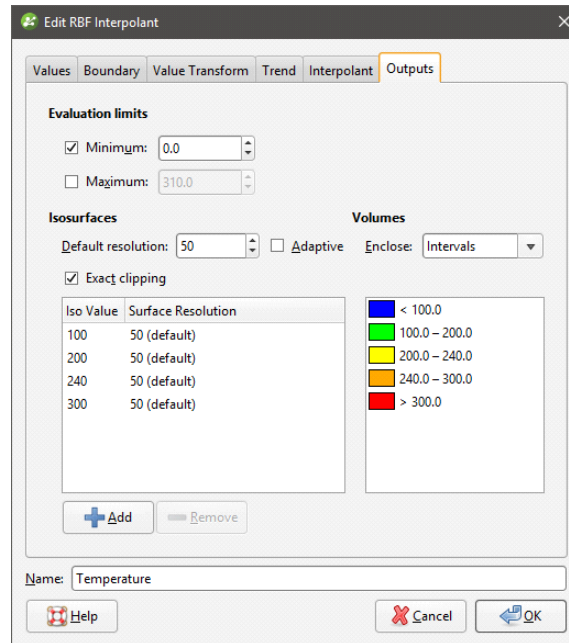

The **Evaluation limits** apply when interpolants are evaluated against other objects in the project. When the limits are enabled, all values outside the limits will be set to the **Minimum** and **Maximum**.

When **Exact clipping** is enabled, the interpolant isosurface will be generated without “tags” that overhang the interpolant boundary. This setting is enabled by default when you create an interpolant.

To add a new isosurface, click the **Add** button and enter the required value. To delete an isosurface, click on it in the list, then click the **Remove** button. You can also change the colours used to display the isosurfaces by clicking on the colour chips.

If you find that grade shells are overlapping, the resolution may be too coarse. Set **Default resolution** to a lower value or enable adaptive resolution in the **Outputs** tab. See [Surface Resolution in Leapfrog Geothermal](#).

Multi-Domained RBF Interpolants

This topic describes creating and editing multi-domained RBF interpolants:

- [Creating a Multi-Domained RBF Interpolant](#)
- [Compositing and Filtering the Values Used](#)
- [Selecting Domains](#)
- [Clipping and Transforming Values](#)

- [Setting the Trend](#)
- [Interpolation Parameters](#)
- [Output Options](#)
- [The Multi-Domained RBF Interpolant in the Project Tree](#)
- [Interpolant and Sub-Interpolant Display](#)
- [Sub-Interpolant Statistics](#)

A multi-domained RBF interpolant is an RBF interpolant that has a number of individual sub-interpolants bounded by the domains of a geological model.

- Changes to all sub-interpolants can be made by editing the parent interpolant.
- Sub-interpolants can be edited to account for local influences on the values used, the trend and interpolation parameters.

A multi-domained RBF interpolant is a single object that can be evaluated as a single column on points and block models.

Creating a Multi-Domained RBF Interpolant

Creating a multi-domained RBF interpolant is a two-step process:

- Selecting the values to be used and the domains in which sub-interpolants will be created.
- Setting the multi-domained RBF interpolant's properties.

To start creating a multi-domained RBF interpolant, right-click on the **Numeric Models** folder and select **New Multi Domained RBF Interpolant**. The **New Multi-domained RBF Interpolant** window will be displayed:

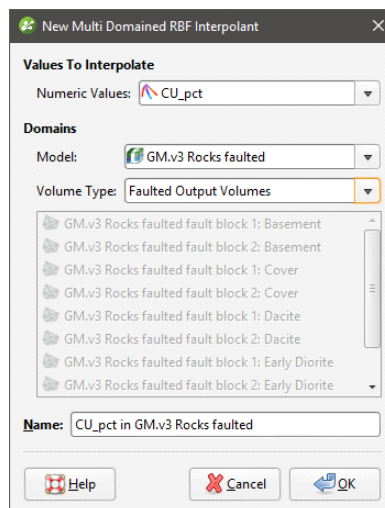

In this window, select the basic parameters for the multi-domained RBF interpolant. You will be able to set additional properties once you click **OK**.

- Select the **Values To Interpolate** from the suitable data available in the project. You will be able to change how data is filtered at the next step, but you will not be able to change the

values used.

- Select the domains used to generate sub-interpolants. These options cannot be changed once the multi-domained RBF interpolant has been created, although you will be able to select which volumes are used to generate sub-interpolants.
 - Select from the geological models available in the project.
 - If the selected **Model** has no faults defined, the **Volume Type** will be set to output volumes.
 - If the selected **Model** is a faulted model, the **Volume Type** can be output volumes, faulted output volumes or fault blocks.

Click **OK** to move on to the next step. The **Edit RBF Interpolant** window will appear:

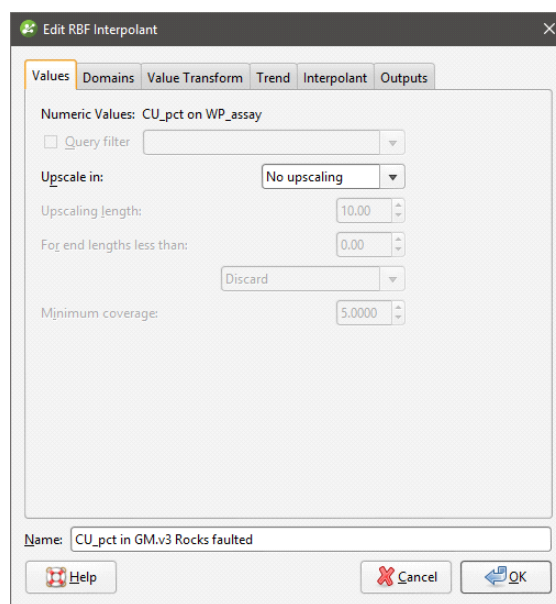

Compositing and Filtering the Values Used

In the **Values** tab, you can apply any query filters that have been defined for the data used.

When numeric values from well data are used to create an interpolant, there are two approaches to compositing that data:

- Composite the well data, then use the composited values to create an interpolant. If you select composited values to create an interpolant, compositing options will be disabled.
- Use well data that hasn't been composited to create an interpolant, then apply compositing settings to the interpolated values. If you are interpolating values that have not been composited and do not have specific **Compositing** values in mind, you may wish to leave this option blank as it can be changed once the model has been created.

If you are interpolating points, compositing options will be disabled.

See [Numeric Composites](#) for more information on the effects of the **Compositing length**, **For end lengths less than** and **Minimum coverage** settings.

Selecting Domains

In the **Domains** tab, you can select the volumes in which sub-interpolants will be generated. You cannot, however, change the geological model or the types of volumes used.

Clipping and Transforming Values

In the **Value Transform** tab, clip data and apply a transformation, if required. See [Clipping and Transforming Values for an RBF Interpolant](#) for more information about the settings in this tab.

You will be able to change the **Value Transform** settings for individual sub-interpolants once the parent interpolant has been created.

Setting the Trend

In the **Trend** tab, you can apply a global or structural trend to the interpolant. See [Changing the Trend for an RBF Interpolant](#) for more information about these options.

You will be able to change the **Trend** settings for the interpolant and individual sub-interpolants once the parent interpolant has been created.

Interpolation Parameters

In the **Interpolant** tab, you can change interpolation parameters. See [Adjusting Interpolation Parameters](#) for more information about these options.

You will be able to change the **Interpolant** settings or import variogram parameters for the interpolant and individual sub-interpolants once the parent interpolant has been created.

Output Options

In the **Outputs** tab, you can change the parameters used to generate interpolant outputs.

The **Evaluation limits** apply when interpolants are evaluated against other objects in the project. When the limits are enabled, all values outside the limits will be set to the **Minimum** and **Maximum**.

Set the **Default resolution** for the interpolant and whether or not the resolution is adaptive. See [Surface Resolution in Leapfrog Geothermal](#) for more information on the effects of these settings. The resolution can be changed once the interpolant has been created, so setting a value when creating the parent interpolant is not vital. A lower value will produce more detail, but calculations will take longer.

When **Exact clipping** is enabled, the interpolant isosurface will be generated without "tags" that overhang the interpolant boundary. This setting is enabled by default when you create an interpolant.

To add a new isosurface, click the **Add** button and enter the required value. To delete an isosurface, click on it in the list, then click the **Remove** button. You can also change the colours used to display the isosurfaces by clicking on the colour chips.

The **Volumes enclose** option determines whether the interpolant volumes enclose **Higher Values**, **Lower Values** or **Intervals**. This option can be changed once the interpolant has been created.

Enter a **Name** for the new interpolant and click **OK**.

Once you have created a multi-domained RBF interpolant, you can adjust its properties as described in [Changing the Settings for an RBF Interpolant](#). You can also change trend, clipping, transformation and interpolation settings for a sub-interpolant. To do this, double-click on a sub-interpolant. For the settings you wish to change, untick the **Inherit parameters from parent** box:

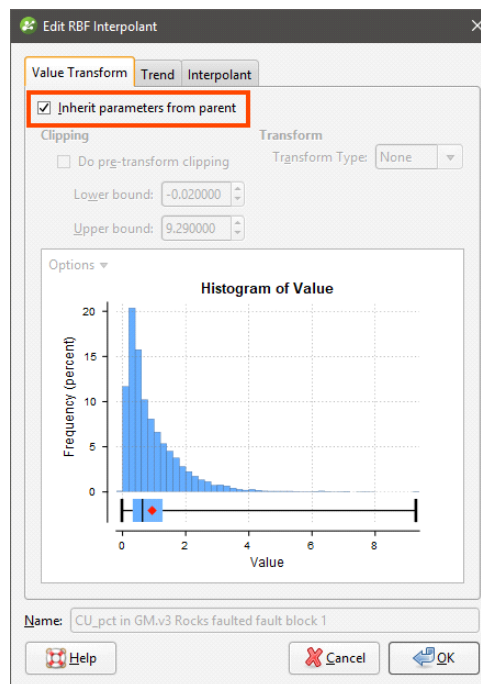

See also:

- [Importing a Variogram Model](#)
- [Copying a Numeric Model](#)
- [Creating a Static Copy of a Numeric Model](#)
- [Exporting Numeric Model Volumes and Surfaces](#)

The Multi-Domained RBF Interpolant in the Project Tree

The new multi-domained RBF interpolant will be created and added to the **Numeric Models** folder. It contains objects that represent different parts of the interpolant:

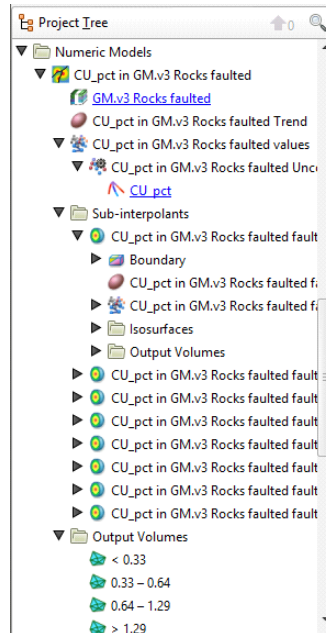

- There is a link to the geological model from which domains are selected for the sub-interpolants.
- The **Trend** object describes the trend applied in the interpolant. See [Changing the Trend for an RBF Interpolant](#) for more information.
- The points data values object contains all the data used in generating the interpolant. See [Adjusting the Values Used](#) for more information.
- The **Sub-interpolants** folder contains the sub-interpolants, which can be edited to change the trend, clipping, transformation and interpolation settings.
- The **Output Volumes** folder contains all the volumes generated in building the interpolant.

Other objects may appear in the project tree under the interpolant as you make changes to it.

Interpolant and Sub-Interpolant Display

Display the interpolant by:

- Dragging the interpolant into the scene or right-clicking on the interpolant and selecting **View Output Volumes**. Both actions display the parent interpolant's output volumes.
- Right-clicking on the interpolant and selecting **View Isosurfaces**. This displays the isosurfaces of each sub-interpolant.

Sub-Interpolant Statistics

You can view the approximated mean for each output volume of a sub-interpolant by right-clicking on the sub-interpolant and selecting **Properties**. Click on the **Statistics** tab:

Approx. Mean			
Interval	Interval Volume	Value	Units
< 0.33	462728.981104	0.33	152700.563764
0.33-0.64	5908102.83111	0.485	2865429.87309
0.64-1.29	32534206.7592	0.965	31395509.5226
> 1.29	0	1.29	0
Approx. Total:			34,413,640

If the original data were specified as concentrations, then the values will need to be multiplied by a density to produce weights.
For example, if the original data were in grams/ton and distances have been specified in metres, then the values will need to be multiplied by the specific gravity (tons/m³) to produce grams.

You can copy the information displayed in the **Statistics** tab to the clipboard for use in other applications.

Indicator RBF Interpolants

An indicator RBF interpolant is a useful way of creating a region of interest in which further processing can be carried out. For example, you can use an indicator RBF interpolant to define a volume that encloses the values that are likely to be above a cut-off threshold and then carry out further interpolation inside that volume.

The rest of this topic describes how to create and modify indicator RBF interpolants. It is divided into:

- [Creating an Indicator RBF Interpolant](#)
- [The Indicator RBF Interpolant in the Project Tree](#)
- [Indicator RBF Interpolant Display](#)
- [Indicator RBF Interpolant Statistics](#)
- [Editing an Indicator RBF Interpolant](#)

Creating an Indicator RBF Interpolant

To create an indicator RBF interpolant, right-click on the **Numeric Models** folder and select **New Indicator RBF Interpolant**. The **New Indicator RBF Interpolant** window will be displayed:

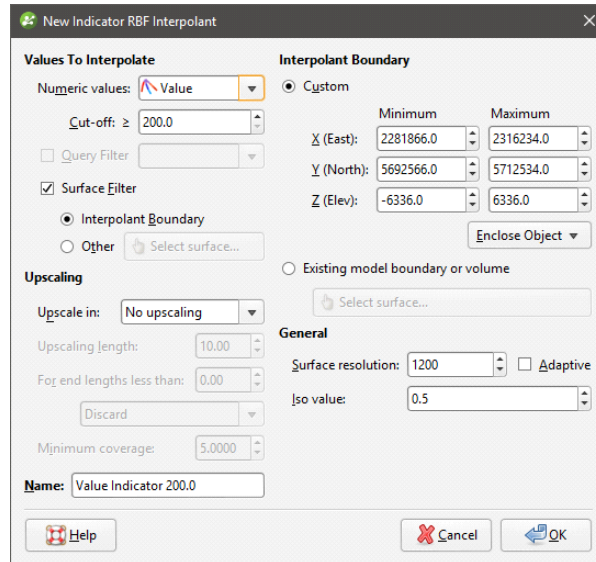

This window is divided into four parts in which you select the values used to create the interpolant, the interpolant boundary, any compositing options and general interpolant properties.

If you are unsure of some settings, most can be changed later. However, the **Numeric values** object selected when the interpolant is created cannot be changed.

Selecting the Values Used

In the **Values To Interpolate** part of the **New Indicator RBF Interpolant** window, you can select the values that will be used and choose whether or not to filter the data and use a subset of those values in the interpolant.

You can build an indicator RBF interpolant from either:

- Numeric data contained in imported well data.
- Points data imported into the **Points** folder.

All suitable data in the project is available from the **Numeric values** list.

Setting the Cut Off

The **Cut-off** value will be used to generate sample points and create two output volumes:

- An **Inside** volume that encloses all values likely to be above or equal to the **Cut-off** value.
- An **Outside** volume that enclose all values likely to be below the **Cut-off** value.

If you are unsure of what **Cut-off** value to use, you can view statistics on the distribution of the data and change the **Cut-off** value once the interpolant has been created.

You can change the names of the **Inside** and **Outside** volumes once the interpolant has been created.

Applying a Query Filter

If you have defined a query filter and wish to use it to create the interpolant, select the filter from the **Query filter** list. Once the model has been created, you can remove the filter or select a different filter.

Applying a Surface Filter

All available data can be used to generate the interpolant or the data can be filtered so that only the data that is within the interpolant boundary or another boundary in the project influences the interpolant. The **Surface Filter** option is enabled by default, but if you wish to use all data in the project, untick the box for **Surface Filter**. Otherwise, you can select the **Interpolant Boundary** or another boundary in the project.

You can use both the **Query Filter** option and the **Surface Filter** option together.

The Interpolant Boundary

There are several ways to set the **Interpolant Boundary**:

- Enter values to set a **Custom** boundary.
- Use the controls in the scene to set the **Custom** boundary dimensions.
- Select another object in the project from the **Enclose Object** list, which could be the numeric values object being interpolated. The extents for that object will be used as the basis for the **Custom** boundary dimensions.
- Select another object in the project to use as the **Interpolant Boundary**. Click the **Existing model boundary or volume** option and select the required object from the list.

Once the interpolant has been created, you can further modify its boundary. See [Modifying an RBF Interpolant's Boundary with Lateral Extents](#) and [Adjusting the Interpolant Boundary](#) in the [RBF Interpolants](#) topic for more information.

Compositing Options

When numeric values from well data are used to create an interpolant, there are two approaches to compositing that data:

- Composite the well data, then use the composited values to create an interpolant. If you select composited values to create an interpolant, compositing options will be disabled.
- Use well data that hasn't been composited to create an interpolant, then apply compositing settings to the interpolated values. If you are interpolating values that have not been composited and do not have specific **Compositing** values in mind, you may wish to leave this option blank as it can be changed once the model has been created.

If you are interpolating points, compositing options will be disabled.

See [Numeric Composites](#) for more information on the effects of the **Compositing length**, **For end lengths less than** and **Minimum coverage** settings.

General Interpolant Properties

Set the **Surface resolution** for the interpolant and whether or not the resolution is adaptive. See [Surface Resolution in Leapfrog Geothermal](#) for more information on the effects of these settings. The resolution can be changed once the interpolant has been created, so setting a value in the **New Indicator RBF Interpolant** window is not vital. A lower value will produce more detail, but calculations will take longer.

An indicator RBF interpolant produces a single isosurface that is used to determine the likelihood of values falling inside or outside of the cut-off threshold. The **Iso value** can be set to values from 0.1 to 0.9. Clicking the arrows changes the **Iso value** in steps of 0.1. To use a different value, enter it from the keyboard. Again, this option can be changed once the interpolant has been created.

Enter a **Name** for the new interpolant and click **OK**.

Once you have created an interpolant, you can adjust its properties by double-clicking on it. You can also double-click on the individual objects that make up the interpolant.

See also:

- [Copying a Numeric Model](#)
- [Creating a Static Copy of a Numeric Model](#)
- [Exporting Numeric Model Volumes and Surfaces](#)

The Indicator RBF Interpolant in the Project Tree

The new interpolant will be created and added to the **Numeric Models** folder. The new interpolant contains other objects that represent different parts of the interpolant:

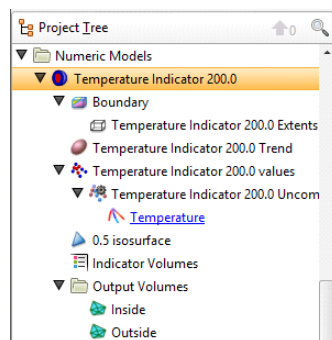

- The **Boundary** object defines the limits of the interpolant. See [Adjusting the Interpolant Boundary](#).
- The **Trend** object describes the trend applied in the interpolant. See [Changing the Trend for an Indicator RBF Interpolant](#).

- The sample grouping object (🌐) is the inside/outside sample grouping, which is generated by backflagging the indicator calculations on the values used (🌐). See [Adjusting the Values Used](#) for information on changing settings relating to how the sample points are grouped.
- The isosurface is set to the specified **Iso value**.
- The **Indicator Volumes** legend defines the colours used to display the volumes.
- The **Output Volumes** folder contains the **Inside** and **Outside** volumes.

Other objects may appear in the project tree under the interpolant as you make changes to it. See [Editing an Indicator RBF Interpolant](#) below for more information on the changes you can make.

Indicator RBF Interpolant Display

Display the interpolant by:

- Dragging the interpolant into the scene or right-clicking on the interpolant and selecting **View Output Volumes**.
- Right-clicking on the interpolant and selecting **View Isosurfaces**.

You can also display the sample grouping (🌐) generated as part of the interpolant, which is useful in making decisions about the **Cut-off** value and the **Iso value**:

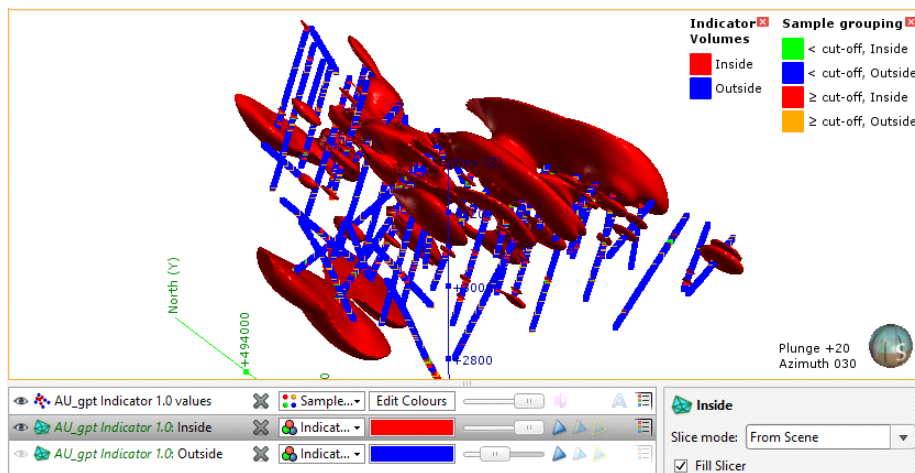

Indicator RBF Interpolant Statistics

You can view the statistics for the indicator RBF interpolant by right-clicking on the interpolant and selecting **Statistics**. Use the information available to adjust the cut-off value and other interpolant properties:

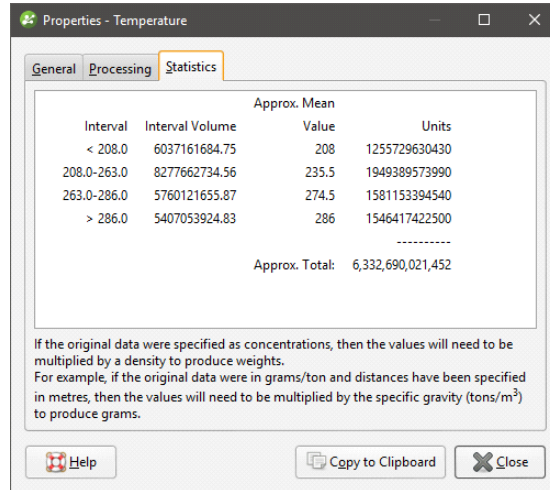

Interval	Interval Volume	Approx. Mean Value	Units
< 208.0	6037161684.75	208	1255729630430
208.0-263.0	8277662734.56	235.5	1949389573990
263.0-286.0	5760121655.87	274.5	1581153394540
> 286.0	5407053924.83	286	1546417422500
Approx. Total:			6,332,690,021,452

If the original data were specified as concentrations, then the values will need to be multiplied by a density to produce weights.
For example, if the original data were in grams/ton and distances have been specified in metres, then the values will need to be multiplied by the specific gravity (tons/m³) to produce grams.

You can copy the information displayed in the **Statistics** tab to the clipboard for use in other applications.

Editing an Indicator RBF Interpolant

To edit an indicator RBF interpolant, you can either double-click on the interpolant in the **Numeric Models** folder or right-click and select **Open**. The window that appears is divided into tabs that let you change the different objects that make up the interpolant. Many of the options are the same for RBF and multi-domained RBF interpolants.

When creating an indicator RBF interpolant, only a basic set of parameters is used. The **Edit Indicator RBF Interpolant** windows provide finer controls over these basic parameters so you can refine the interpolant to factor in real-world observations and account for limitations in the data.

- [Adjusting the Values Used](#)
- [Compositing Parameters for an Indicator RBF Interpolant](#)
- [Adjusting the Interpolant Boundary](#)
- [The Cut-Off Value](#)
- [Changing the Trend for an Indicator RBF Interpolant](#)
- [Adjusting Interpolation Parameters](#)
- [Indicator RBF Interpolant Surfacing and Volume Options](#)

Adjusting the Values Used

The **Values** tab in the **Edit Indicator RBF Interpolant** window shows the values used in creating the interpolant and provides options for filtering the data. You cannot change the values used, but you can filter the values using the **Query filter** and **Surface filter** options.

The sample grouping object (🌐) in the project tree is not the values used, but is instead the inside/outside sample grouping generated by backflagging the indicator calculations on the input values (🌐). You can adjust the input values using a contour polyline or by adding points. Both options are available by expanding the interpolant in the project tree, then right-clicking on the sample grouping object (🌐):

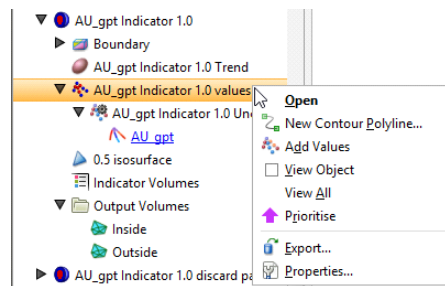

These options are described below in [Adding a Contour Polyline](#) and [Adding Points](#).

To apply a query filter, tick the **Query filter** box in the **Values** tab and select the available queries from the list.

To change the object used as the **Surface filter**, select the required object from the list. Note that the list contains an object that defines the interpolant's own boundary, which can be adjusted in the **Boundary** tab.

Adding a Contour Polyline

You can adjust the values using contour polylines set to inside (1), outside (0) or to the iso-value. Adding a contour polyline does not affect the indicator's statistics.

Setting a contour to inside or outside is a useful way of controlling blowouts. Here, the inside volume occurs in the corner of the model because of the high-value points at the bottom of the well:

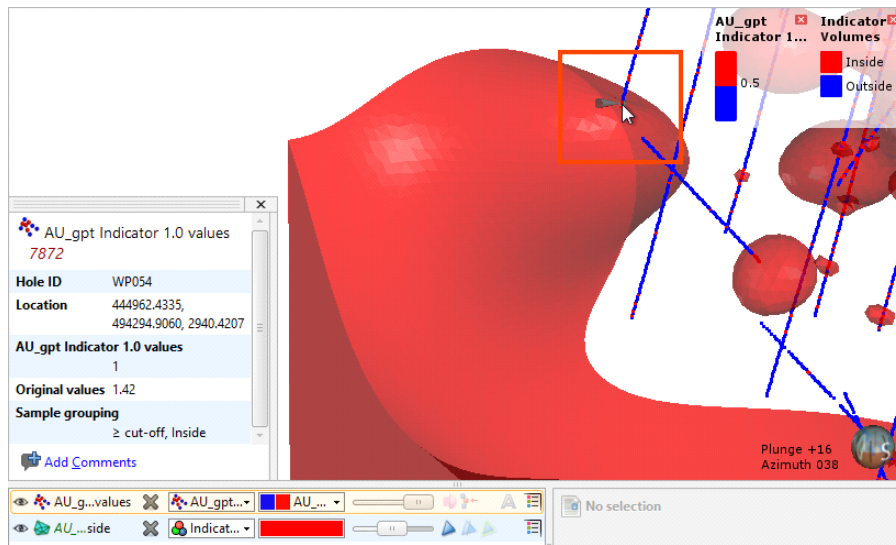

This can be adjusted by drawing a contour polyline below the bottom of the wells and setting it to the outside value. For example, adding a polyline (in yellow) below the bottom of well shown above removes the blowout (the part of the mesh with only the edges shown):

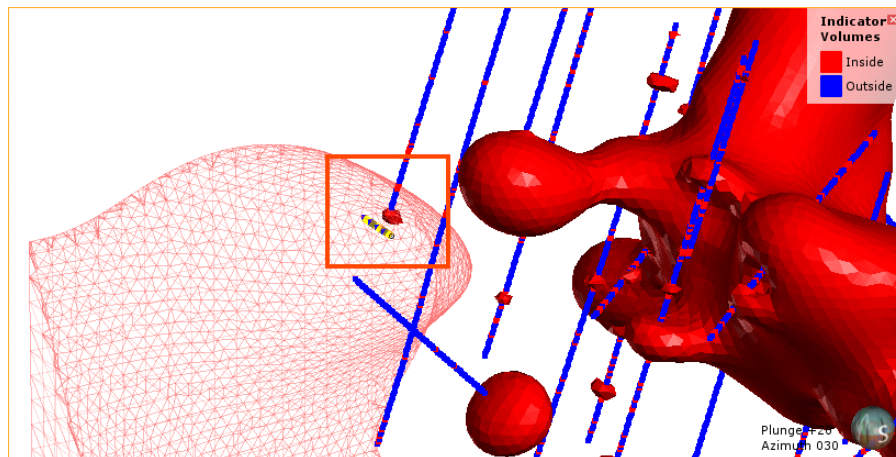

Polylines must be drawn either on an object or on the slicer. Drawing a contour polyline precisely on the well gives Leapfrog Geothermal conflicting data at the same location, which is why the polyline should be drawn below the well. To draw a polyline below a well, first draw the polyline on the well, then move its nodes so the polyline lies below the well.

To add a contour polyline, expand the interpolant in the project tree. Right-click on the values object and select **New Contour Polyline**:

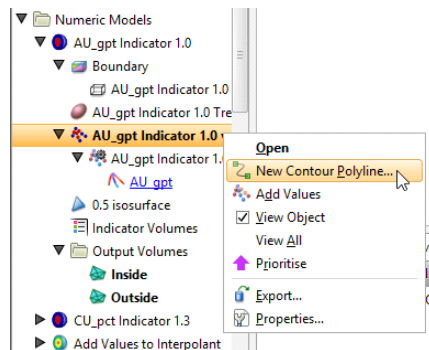

Next, choose whether you will draw a new polyline or use one already in the project, then select the contour value:

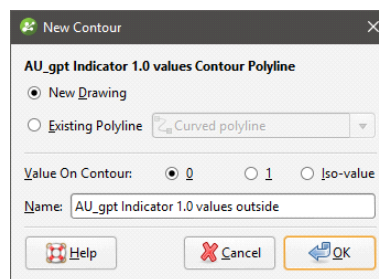

Only GIS lines, polylines imported into Leapfrog Geothermal or polylines created using the straight line drawing tool can be used to create contour lines.

Click **OK**. If you have chosen the **New Drawing** option, the new object will be created in the project tree and drawing tools will appear in the scene. Start drawing in the scene as described in [Drawing in the Scene](#). When you have finished drawing, click the **Save** button (📁). The new contour will automatically be added to the interpolant and will appear in the project tree as part of the interpolant's values object.

To edit the polyline, right-click on it and select **Edit Polyline** or add it to the scene and click the **Edit** button (✏️) in the shape list. If you wish to remove a contour polyline from the interpolant, right-click on it in the project tree and select **Delete** or **Remove**.

You cannot change the value on the contour once it has been created. You can, however, share the polyline and use it to create a new contour polyline. To do this, right-click on it in the project tree and select **Share**. The polyline will then be added to the **Polylines** folder and can be used elsewhere in the project.

Adding Points

To add points to an indicator RBF interpolant, right-click on the values object in the project tree and select **Add Values**. Leapfrog Geothermal will display a list of all suitable points objects in the project. Select an object and click **OK**.

A hyperlink to the points object will be added to the values object in the project tree. To remove the points object, right-click on the points object and select **Remove**.

Compositing Parameters for an Indicator RBF Interpolant

When an indicator RBF interpolant has been created from values that have not been composited, compositing parameters can be changed by double-clicking on the interpolant in the project tree, then clicking on the **Compositing** tab.

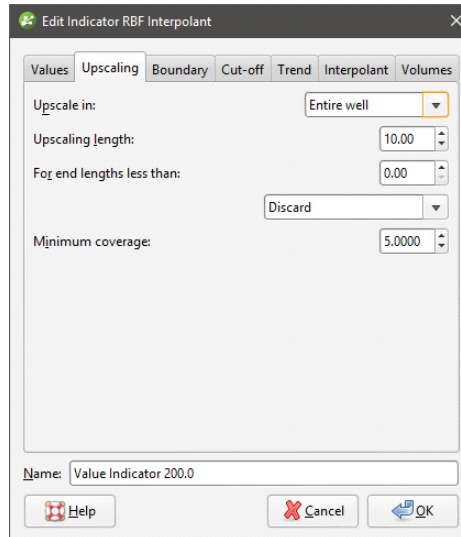

The **Compositing** tab will only appear for interpolants created from well data that has not been composited.

You can composite in the entire well or only where the data falls inside the interpolant boundary. See [Numeric Composites](#) for more information on the effects of the **Compositing length**, **For end lengths less than** and **Minimum coverage** settings.

Adjusting the Interpolant Boundary

To change an indicator RBF interpolant's boundary, double-click on the interpolant in the project tree, then click on the **Boundary** tab:

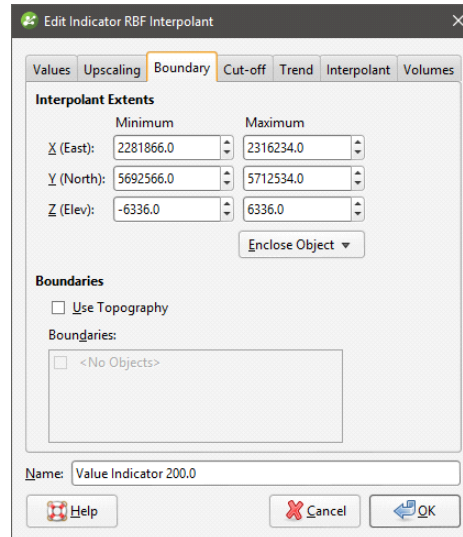

Controls to adjust the boundary will also appear in the scene.

Tick the **Use Topography** box to use the topography as a boundary. The topography is normally not used as a boundary for interpolants and so this option is disabled when an interpolant is first created.

The **Boundaries** list shows objects that have been used to modify the boundary. You can disable any of these lateral extents by unticking the box.

Techniques for creating lateral extents for indicator RBF interpolants are the same as those for RBF interpolants. See [Modifying an RBF Interpolant's Boundary with Lateral Extents](#) for more information.

The Cut-Off Value

To change the **Cut-off** value for an indicator RBF interpolant, double-click on the interpolant in the project tree, then click on the **Cut-off** tab. The tab also shows the distribution of the data used to create an indicator interpolate:

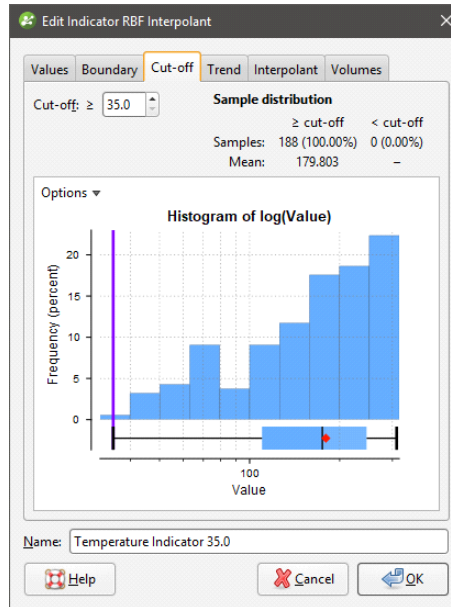

Click on the **Options** button to change the histogram's display, including the **Bin Width**. Adjust the **Cut-off** value, if required, and click **OK** to process the changes.

Changing the Trend for an Indicator RBF Interpolant

You can apply a global trend or a structural trend to an indicator RBF interpolant. To do this, add the interpolant to the scene, then double-click on the interpolant in the project tree. Click on the **Trend** tab in the **Edit Indicator RBF Interpolant** window.

Techniques for setting a trend for an indicator RBF interpolant are the same as those for an RBF interpolant. See [Using a Global Trend](#) and [Using a Structural Trend](#) in [Changing the Trend for an RBF Interpolant](#).

Adjusting Interpolation Parameters

To adjust interpolation parameters for an indicator RBF interpolant, double-click on the interpolant in the project tree, then click on the **Interpolant** tab:

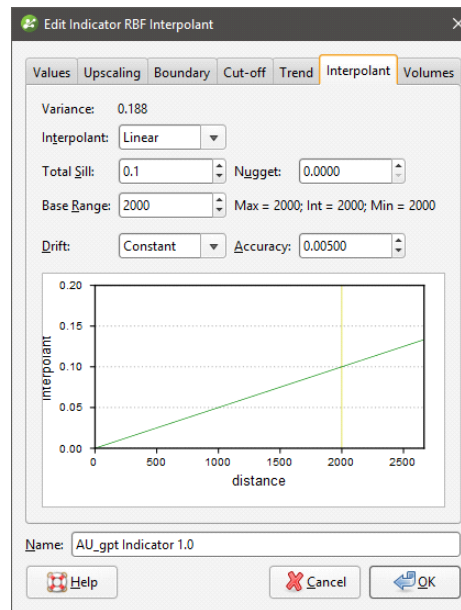

Two models are available, the spheroidal interpolant and the linear interpolant. See [The Spheroidal Interpolant Function](#) and [The Linear Interpolant Function](#) for more information on the settings in this tab.

Indicator RBF Interpolant Surfacing and Volume Options

To change the properties of the isosurface for an indicator RBF interpolant, double-click on the interpolant in the project tree, then click on the **Volumes** tab:

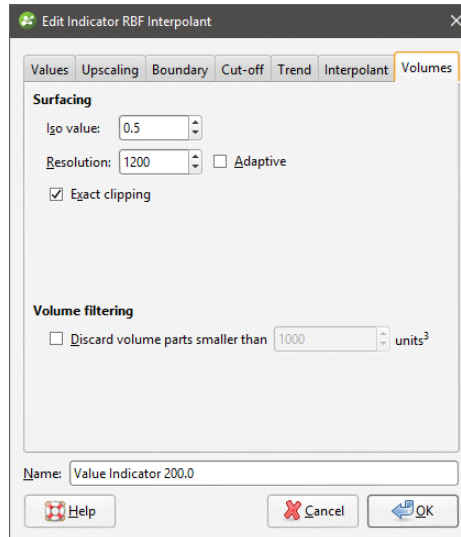

An alternative to double-clicking on the interpolant is to double-click on one of the output volumes, which opens the **Edit Indicator RBF Interpolant** window with the **Volumes** tab displayed.

The **Iso value** can be set to values from 0.1 to 0.9. Clicking the arrows changes the **Iso value** in steps of 0.1. To use a different value, enter it from the keyboard.

Setting a lower value for **Resolution** will produce more detail, but calculations can take longer. You can also set the resolution to be adaptive. See [Surface Resolution in Leapfrog Geothermal](#) for more information.

When **Exact clipping** is enabled, the interpolant isosurface will be generated without “tags” that overhang the interpolant boundary. This setting is enabled by default when you create an interpolant.

Use **Volume filtering** to discard smaller parts of the volumes in which you do not wish to carry out further processing. For example, this interpolant has numerous small volumes:

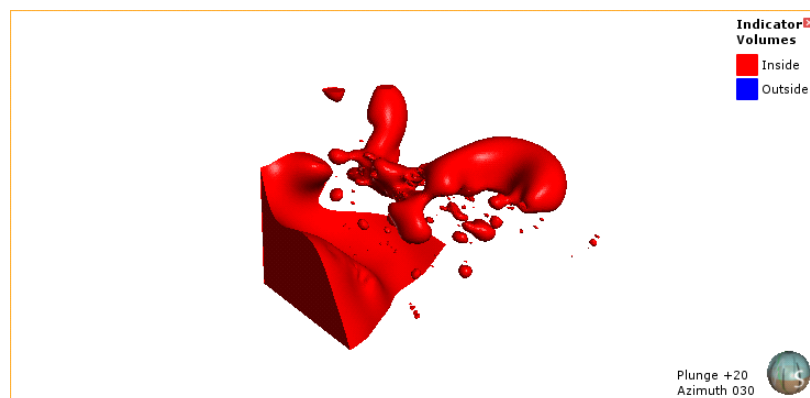

Enabling **Volume filtering** removes the smaller parts:

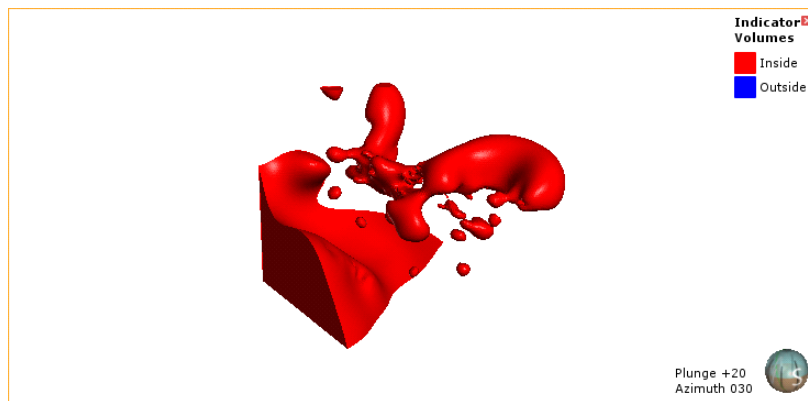

Distance Functions

A distance function calculates the distance to a set of points. This topic describes how to create and modify distance functions. It is divided into:

- [Creating a Distance Function](#)
- [The New Distance Function in the Project Tree](#)

Creating a Distance Function

To create a distance function, right-click on the **Numeric Models** folder and select **New Distance Function**. The **New Distance Function** window will be displayed:

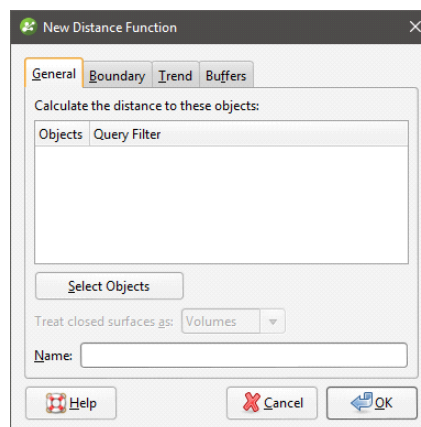

Click **Select objects** to choose from the objects available in the project. For wells, points, GIS points and imported GIS lines, you can apply any filter that has been defined for that object.

If any of the objects selected are closed surfaces, you can choose whether these surfaces are treated as **Volumes** or as **Surfaces**.

- When treated as **Volumes**, buffers will be generated only on the outside of the mesh. If the mesh is inverted, buffers will appear on its inner surface.
- When treated as **Surfaces**, buffers will be generated on both sides of the mesh.

For example, here a distance function has been created using a sphere and one isosurface set to 100. The inner surface of the sphere is red, indicating that it is the inside of the mesh. The sphere is treated as a volume and there is a single isosurface (yellow) outside of the sphere:

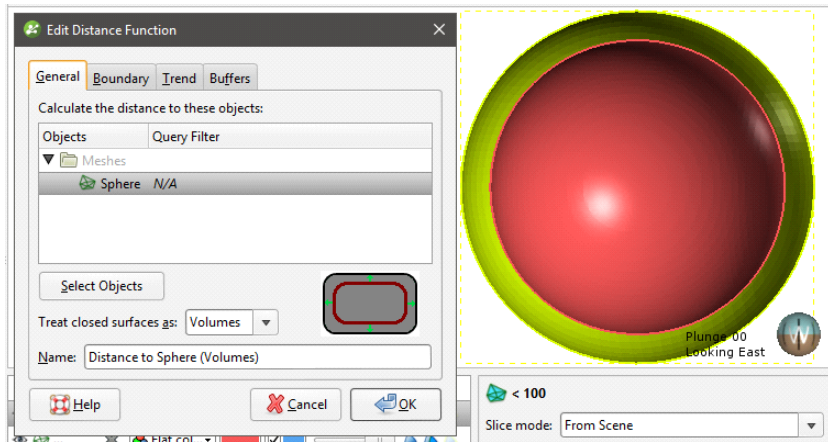

When the orientation of the sphere is reversed, the isosurface (yellow) is generated on the inner surface of the sphere:

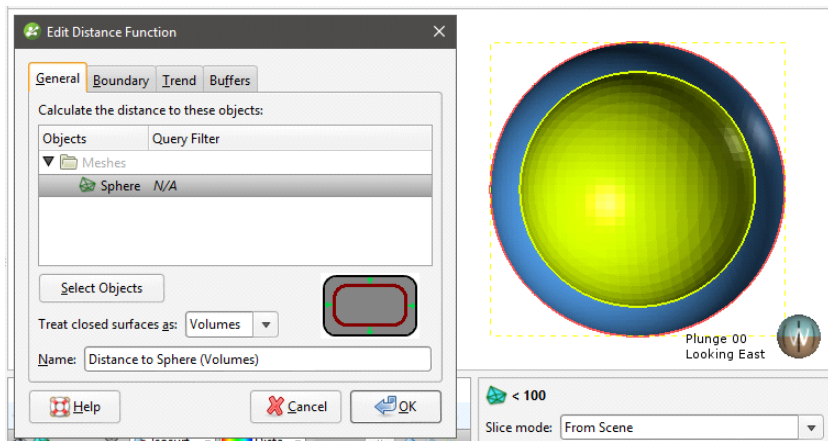

However, when the sphere is treated as a surface rather than as a volume, isosurfaces are generated on both sides of the sphere:

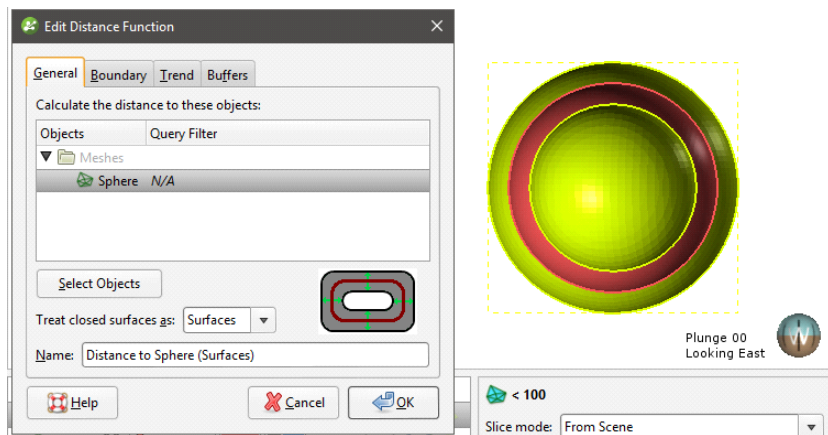

If you are unsure of some settings, most can be changed later. For a basic distance function click **Select Objects** to select from the suitable objects available in the project, then click on the

Buffers tab to define at least one buffer so that the distance function can be visualised in the scene.

See:

- [Setting the Boundary](#)
- [Setting a Trend](#)
- [Adding Buffers](#)
- [The New Distance Function in the Project Tree](#)

Setting the Boundary

In the **Boundary** tab, you can set whether the function boundary is clipped or unclipped. **No distance buffer clipping** is the default setting, but if you choose to clip the buffers, you can choose between:

- Sharing another object's extents
- Defining a set of extents that is independent of other objects in the project.

When you select the **Shared with** option, the distance function will be updated when the extents object it shares is updated.

Setting a Trend

In the **Trend** tab, you can set a trend using the moving plane or by entering the required values. You can also use the **Set to** list to choose different options used in the project. **Isotropic** is the default option used when the function is created.

The **Ellipsoid Ratios** determine the relative shape and strength of the ellipsoids in the scene, where:

- The **Maximum** value is the relative strength in the direction of the green line on the moving plane.
- The **Intermed.** value is the relative strength in the direction perpendicular to the green line on the moving plane.
- The **Minimum** value is the relative strength in the direction orthogonal to the plane.

Adding Buffers

To add buffers, click on the **Buffers** tab, then click the **Add** button:

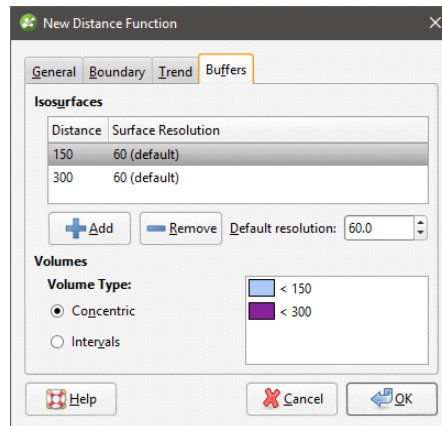

Enter the required value. To delete a buffer, click on it in the list, then click the **Remove** button. You can also change the colours used to display the buffers by clicking on the colour chips.

There are two options for **Volume Type** that affect how the buffers are calculated when more than one buffer is used. Selecting **Concentric** produces higher distance buffers that include the lower distance buffers, whereas selecting **Intervals** produces discrete, non-intersecting buffers.

The **Default resolution** setting is used for all new buffers and for existing buffers that use the default resolution.

The New Distance Function in the Project Tree

Click **OK** to create the distance function, which will be added to the **Numeric Models** folder. The new distance function contains objects representing different parts of the function, which can be expanded to show the inputs to each part of the function:

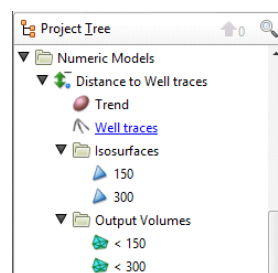

- The **Trend** object that describes the trend applied.
- Hyperlinks to objects used for the distance function.
- An **Isosurfaces** folder that contains all the meshes generated in building the distance function.
- An **Output Volumes** folder that contains all the distance buffer meshes.

Other objects may appear in the project tree under the function as you make changes to it.

Display the function by dragging it into the scene or by right-clicking on it and selecting **View Buffers**.

Once you have created a distance function, you can adjust its properties by double-clicking on it. You can also double-click on the individual objects that make up the function.

Inverse Distance Weighted (IDW) Grid Interpolants

Whereas RBF interpolants are suited to irregularly-spaced sparse data, an inverse distance weighted (IDW) interpolant is useful in generating isosurfaces and volumes from larger datasets, such as regular or semi-regular grids. An IDW interpolant interpolates points by taking an average of up to eight nearby samples, weighted by distance.

In Leapfrog Geothermal, you can create an IDW interpolant from gridded geophysical data such as Magnetotelluric models, UBC grids and GOCAD models.

Magnetotelluric models imported into Leapfrog Geothermal version 3.3 and earlier cannot be used to generate an IDW interpolant.

The rest of this topic describes how to create and modify IDW interpolants. It is divided into:

- [Creating an IDW Interpolant](#)
- [The IDW Interpolant in the Project Tree](#)
- [Interpolant Display](#)
- [IDW Interpolant Statistics](#)
- [Modifying an IDW Interpolant's Boundary with Lateral Extents](#)
- [Changing the Settings for an IDW Interpolant](#)

Creating an IDW Interpolant

To create an IDW interpolant, right-click on the **Numeric Models** folder and select **New IDW Grid Interpolant**. The **New Inverse Distance Weighted Grid Interpolant** window will be displayed:

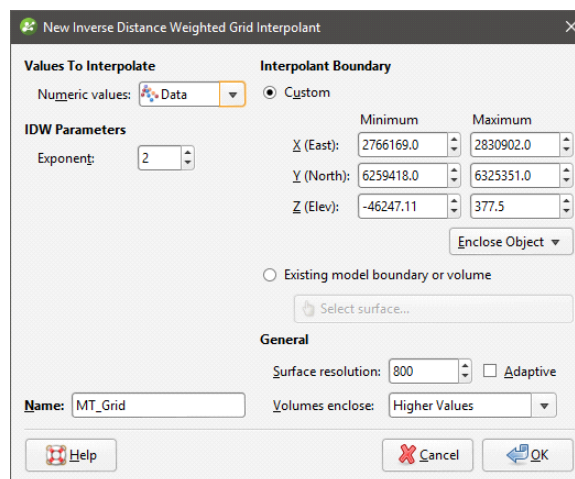

This window is divided into four parts that determine the values used to create the interpolant, the IDW parameters, the interpolant boundary and general interpolant properties.

If you are unsure of some settings, most can be changed later. However, the **Numeric values** object selected when the interpolant is created cannot be changed.

Values Used

You can build an IDW interpolant from Magnetotelluric models, UBC grids and GOCAD models. All suitable data in the project is available from the **Numeric values** list.

IDW Parameters

The **Exponent** setting adjusts the strength of the weighting as distance increases. A higher exponent will result in a weaker weight for the same distance.

The Interpolant Boundary

There are several ways to set the **Interpolant Boundary**:

- Enter values to set a **Custom** boundary.
- Use the controls in the scene to set the **Custom** boundary dimensions.
- Select another object in the project from the **Enclose Object** list, which could be the numeric values object being interpolated. The extents for that object will be used as the basis for the **Custom** boundary dimensions.
- Select another object in the project to use as the **Interpolant Boundary**. Click the **Existing model boundary or volume** option and select the required object from the list.

Once the interpolant has been created, you can further modify its boundary. See [Modifying an IDW Interpolant's Boundary with Lateral Extents](#) and [Adjusting the Interpolant Boundary](#) below.

General Interpolant Properties

Set the **Surface resolution** for the interpolant and whether or not the resolution is adaptive. See [Surface Resolution in Leapfrog Geothermal](#) for more information on the effects of these settings. The resolution can be changed once the interpolant has been created, so setting a value in the **New Inverse Distance Weighted Grid Interpolant** window is not vital. A lower value will produce more detail, but calculations will take longer.

The **Volumes enclose** option determines whether the interpolant volumes enclose **Higher Values, Lower Values** or **Intervals**. Again, this option can be changed once the interpolant has been created.

Enter a **Name** for the new interpolant and click **OK**.

Once you have created an IDW interpolant, you can adjust its properties by double-clicking on it. You can also double-click on the individual objects that make up the interpolant.

See also:

- [Copying a Numeric Model](#)
- [Creating a Static Copy of a Numeric Model](#)
- [Exporting Numeric Model Volumes and Surfaces](#)

The IDW Interpolant in the Project Tree

The new interpolant will be created and added to the **Numeric Models** folder. The new interpolant contains objects that represent different parts of the interpolant:

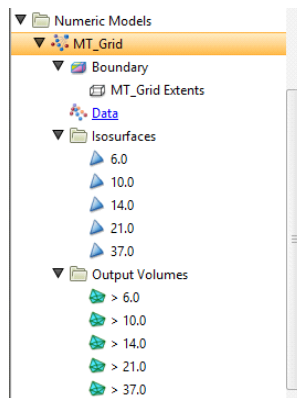

- The **Boundary** object defines the limits of the interpolant. See [Modifying an IDW Interpolant's Boundary with Lateral Extents](#).
- The points data values object contains all the data used in generating the interpolant. See [Adjusting the Values Used](#).
- The **Isosurfaces** folder contains all the meshes generated in building the interpolant.
- The **Output Volumes** folder contains all the volumes generated in building the interpolant.

Other objects may appear in the project tree under the interpolant as you make changes to it.

Interpolant Display

Display the interpolant by displaying the output volumes or the isosurfaces:

- To view the interpolant's output volumes, drag the interpolant into the scene or right-click on the interpolant and select **View Output Volumes**.
- To view the interpolant's isosurfaces, right-click on the interpolant and select **View Isosurfaces**.

IDW Interpolant Statistics

You can view the approximated mean for each output volume by right-clicking on the interpolant and selecting **Properties**. Click on the **Statistics** tab:

Iso value	Volume
6	259210946335000
10	236527799886000
14	192909676008000
21	151697478194000
37	92929256941200

Interval	Interval Volume	Approx. Mean Value	Units
6.0-10.0	22683146448100	8	181465171585000
10.0-14.0	43618123878400	12	523417486541000
14.0-21.0	41212197814200	17.5	721213461749000
21.0-37.0	58768221252600	29	1.70428e+15
> 37.0	92929256941200	37	3.43838e+15

Approx. Total: 6.56876e+15

You can copy the information displayed in the **Statistics** tab to the clipboard for use in other applications.

Modifying an IDW Interpolant's Boundary with Lateral Extents

IDW interpolants are created with a basic set of rectangular extents that can then be refined using other data in the project. Applying an extent to the interpolant can restrict modelling to a particular region of interest, which will reduce processing time if you are working with a large grid.

To apply an extent, expand the IDW interpolant in the project tree. Right-click on the **Boundary** object and select from the **New Lateral Extent** options. Follow the prompts to create the extent, which will then appear in the project tree under the interpolant's **Boundary** object.

New extents are automatically applied to the boundary being modified. Leapfrog Geothermal usually orients a new extent correctly, with red presenting the inside face of the extent and blue representing the outside face. If this is not the case, you can change the orientation by right-clicking on the extent in the project tree and selecting **Swap Inside**.

See [Modifying an RBF Interpolant's Boundary with Lateral Extents](#) in the [RBF Interpolants](#) topic for more information on creating and modifying lateral extents for an IDW interpolant, as the techniques used are the same. Extents for an IDW interpolant can be created from:

- Polylines
- GIS data
- Points data
- Surfaces

- Structural data
- A distance to points
- A distance function

Changing the Settings for an IDW Interpolant

To change the settings for an IDW interpolant, you can either double-click on the interpolant in the **Numeric Models** folder or right-click and select **Open**. When creating an IDW interpolant, only a basic set of parameters is used. The **Edit Inverse Distance Weighted Grid Interpolant** window provides finer controls over these basic parameters so you can refine the interpolant to factor in real-world observations and account for limitations in the data.

The **Interpolant** tab contains the **Exponent** setting, which is described in [IDW Parameters](#) above.

Adjusting the Interpolant Boundary

See [Modifying an RBF Interpolant's Boundary with Lateral Extents](#) in the [RBF Interpolants](#) topic for information on creating and working with lateral extents.

To change an IDW interpolant's boundary, double-click on the interpolant in the project tree, then click on the **Boundary** tab:

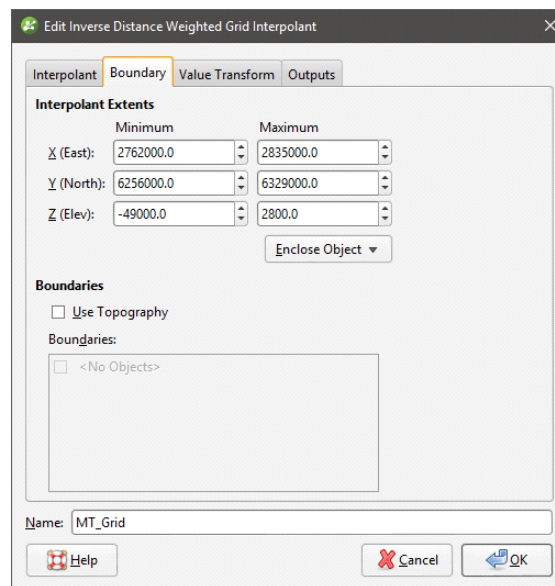

Controls to adjust the boundary will also appear in the scene.

Tick the **Use Topography** box to use the topography as a boundary. The topography is normally not used as a boundary for interpolants and so this option is disabled when an interpolant is first created.

The **Boundaries** list shows objects that have been used to modify the boundary. You can disable any of these lateral extents by unticking the box.

Lateral extents can be used to restrict modelling to a particular area of interest; for example, modelling can be restricted to a known distance from wells by applying a distance function as a lateral extent.

Clipping and Transforming Values for an IDW Interpolant

To clip data and apply a transformation to an IDW interpolant, double-click on the interpolant in the project tree, then click on the **Value Transform** tab:

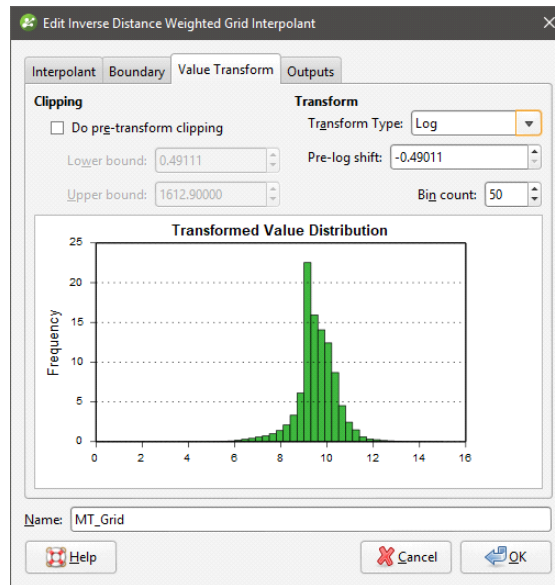

The settings in this tab are the same as those for RBF interpolants. See [Clipping and Transforming Values for an RBF Interpolant](#) in the [RBF Interpolants](#) topic for more information.

Output Settings for an IDW Interpolant

You can change the parameters used to generate IDW interpolant outputs by double-clicking on the interpolant, then clicking on the **Outputs** tab.

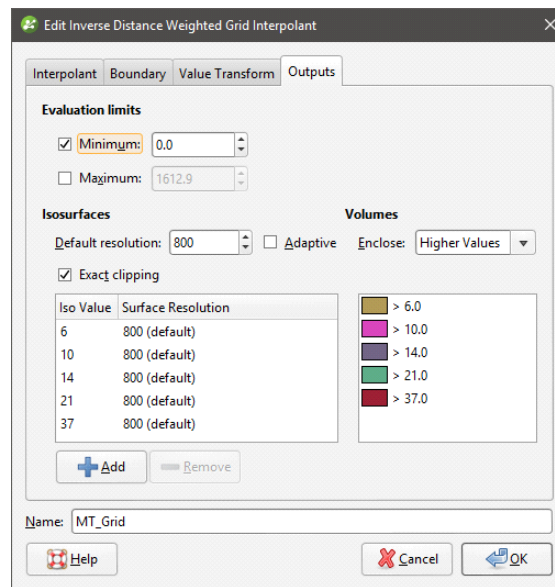

The **Evaluation limits** apply when interpolants are evaluated against other objects in the project. When the limits are enabled, all values outside the limits will be set to the **Minimum** and **Maximum**.

When **Exact clipping** is enabled, the interpolant isosurface will be generated without “tags” that overhang the interpolant boundary. This setting is enabled by default when you create an interpolant.

To add a new isosurface, click the **Add** button and enter the required value. To delete an isosurface, click on it in the list, then click the **Remove** button. You can also change the colours used to display the isosurfaces by clicking on the colour chips.

If you find that grade shells are overlapping, the resolution may be too coarse. Set **Default resolution** to a lower value or enable adaptive resolution in the **Outputs** tab. See [Surface Resolution in Leapfrog Geothermal](#).

Combined Models

This topic describes creating and working with combined models. It is divided into:

- [Creating a Combined Model](#)
- [The Combined Model in the Project Tree](#)
- [Editing a Combined Model](#)
- [Displaying a Combined Model](#)
- [Creating a Static Copy of a Combined Model](#)
- [Combined Model Export](#)

A combined model uses information from up to four geological models, interpolants and distance functions in order to visualise relationships between different types of data in the project. For example, you could combine a geological model with an interpolant to see what lithologies higher grades are occurring in.

Creating a Combined Model

To create a combined model, right-click on the **Combined Models** folder in the project tree and select **New Combined Model**. In the window that appears, select the models you wish to combine, then click **OK**:

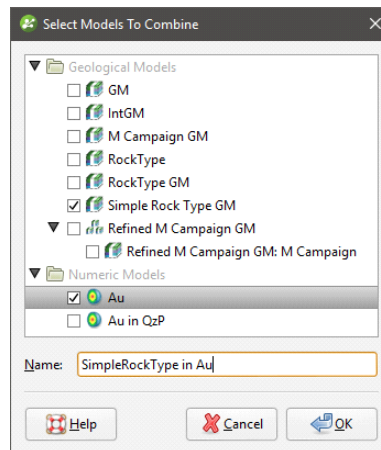

Once you have created a combined model, you cannot edit it to add new models or remove existing ones.

The next step is to select the output volumes to use in the combined model and arrange them in order of priority. For this combined model, the QzP volume from the selected geological model will be subdivided using information from the Au interpolant:

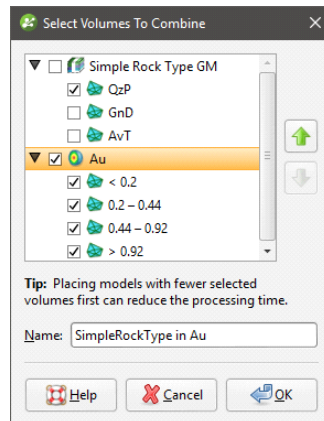

If you are using a distance buffer with concentric buffers, you will be able to select only one volume.

Click **OK** to generate the model, which will appear in the project tree in the **Combined Models** folder.

Add the model to the scene to view the results:

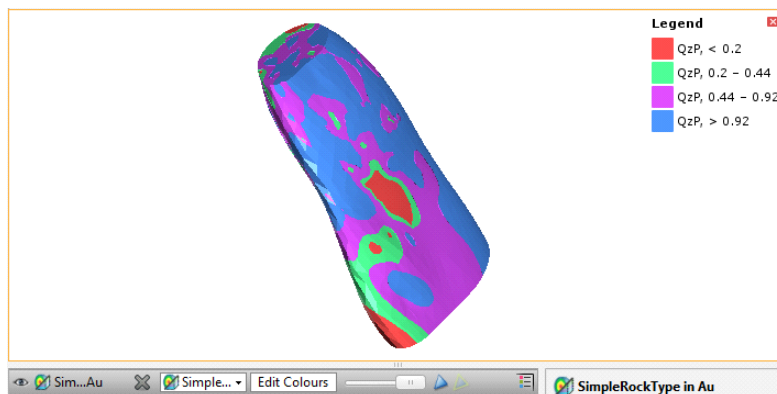

The Combined Model in the Project Tree

In the project tree, the combined model includes hyperlinks to the models used to create the combined model:

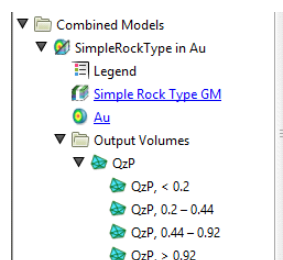

Changes made in the original models will be reflected in the combined model.

Editing a Combined Model

To change how the volumes from the source models are combined, double-click on the combined model in the project tree. Once you have created a combined model, you cannot add new models to it, nor can you remove a selected model.

Displaying a Combined Model

To change the colours used to display the model, double-click on the **Legend** object (📄). In the window that appears, click on the colour chip for each category and change it as described in [Single Colour Display](#).

To set multiple categories to a single colour, use the Shift and Ctrl keys to select the colour chips you wish to change, then click on one of the colour chips. The colour changes you make will be made to all selected categories.

Creating a Static Copy of a Combined Model

Creating a static copy preserves a snapshot of a combined model that does not change, even when changes are made to the data on which the original model was dependent. This is a useful way of storing historical models and comparing models. Static copies can be exported from Leapfrog Geothermal, as described in [Combined Model Export](#) below.

To create a static copy of a combined model, right-click on it in the project tree and select **Static Copy**. Enter a name for the copy of the model and click **OK**. The copy will be added to the **Combined Models** folder.

The static copy (🌐) is made up of a **Legend** object (📄) and the output volumes (🌐).

Static models created in versions of Leapfrog Geothermal before 2.8 copied only the output volumes and the legend, and the static model appeared in the shape list only as a single line. When these static models are upgraded and displayed in the scene, the individual output volumes will be added to the shape list.

To view the date a static copy was created, right-click on it in the project tree and select **Properties**. The date the copy was created is in the **General** tab.

Combined Model Export

There are two options for exporting a combined model's output volumes. These are:

- Export an output volume as a mesh. Right-click on it in the project tree and click **Export**. You will be prompted for a file name and location. See [Exporting a Single Mesh](#).
- Export multiple output volumes. Right-click on the combined model in the project tree and select **Export**. See [Exporting Multiple Meshes from Models](#).

Flow Models

Geological models created in Leapfrog Geothermal can be used as the basis for MODFLOW, FEFLOW, TOUGH2 and TETRAD models. You can create flow models directly in Leapfrog Geothermal and assign hydrological/material properties based on the lithologies in the geological model. Flow models can be exported for use in other applications, and you can import existing flow models and use them as the basis for the construction of new models. Flow models can be displayed in the scene, and time-dependent output data can also be visualised.

All tools for building flow models are accessed by right-clicking on the **Flow Models** folder and the objects in it. Imported objects and objects created while building a flow model are also stored in the **Flow Models** folder, and more complex functions can be carried out by right-clicking on individual objects.

MODFLOW Models

Once you have created a geological model, you can use it as the basis for a MODFLOW model. You can also import existing MODFLOW models and assign lithologies from a geological model.

Steps for creating a MODFLOW model that can be exported and run outside Leapfrog Geothermal are:

1. Create a geological model.
2. Create the MODFLOW model using the geological model to set the grid spacing and layers.
3. Evaluate the new model against a geological model, if it wasn't when it was created.
4. Edit the hydrological properties.
5. Export the MODFLOW model to MODFLOW or Groundwater Vistas.

Once the model has been processed outside of Leapfrog Geothermal, the model can be imported into Leapfrog Geothermal and visualised in the scene.

Creating MODFLOW models in Leapfrog Geothermal has the advantage that the resolution can be easily changed and the properties of the grid can be made to honour boundaries defined in geological models. See [Creating a MODFLOW Model](#).

See [MODFLOW Model Display](#) for information on options for displaying models in the scene.

Models created in Leapfrog Geothermal can be evaluated against a geological model when they are created. Models imported into Leapfrog Geothermal or that were not evaluated when they were created can be evaluated as described in [MODFLOW Evaluations](#).

Once a model has been defined and evaluated against a geological model, hydrological properties can be assigned and the grid can be exported. See [MODFLOW Hydrological Properties](#) and [MODFLOW Model Export](#).

Creating a MODFLOW Model

To create a new MODFLOW model, you must first have at least one geological model defined in the project. Once this has been defined, add the geological model to the scene. Right-click on the **Flow Models** folder and select **MODFLOW > New Structured Model**. The **New MODFLOW**

Model window will be displayed, together with controls in the scene that will help you to set the grid extents:

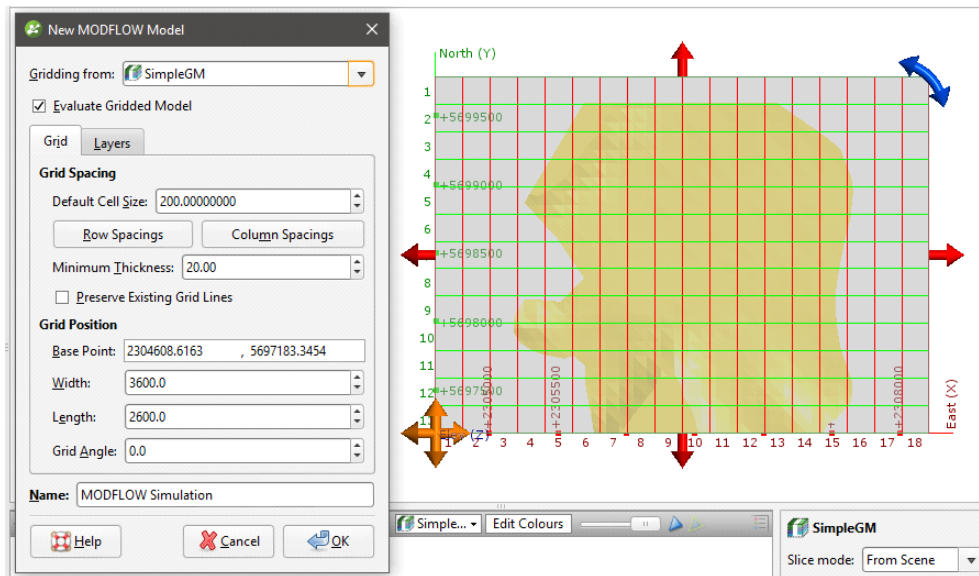

The new MODFLOW grid will be based on the geological model in the **Gridding from** setting. If you wish to use a geological model other than the one selected when the window is opened, select it from the list. The grid dimensions will be updated in the scene.

If the **Evaluate Gridded Model** box is ticked, the selected geological model will be evaluated on the new grid and set as the evaluation for export. If you do not wish to evaluate the geological model on the grid, untick the box. You will still be able to use the layers in the geological model to control the grid layers.

The **Preserve Existing Grid Lines** option is used when setting a non-uniform grid in the scene window. If you are going to define a non-uniform grid in this way, create the model with the **Default Cell Size** set to the smallest cell size you wish to use, then edit it as described in [Editing a MODFLOW Model](#).

The grid should be slightly smaller than the selected geological model. Any MODFLOW cells that exist outside the geological model will be marked as inactive when the grid is exported to MODFLOW .

Horizontal Grid Spacing

By default, the horizontal grid for the model is uniform, with the size of each cell set by the **Default Cell Size** value. You can change the horizontal grid by editing row and column spacings. When you click on **Row Spacings** or **Column Spacings**, the **Edit Spacings** window will be displayed:

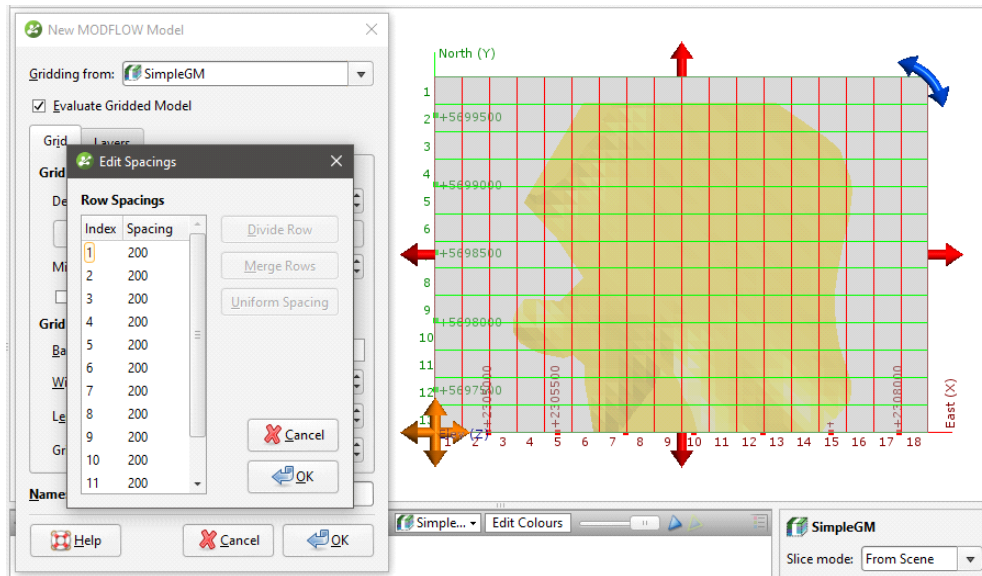

Changes made in the **Edit Spacings** window will be reflected in the scene.

There are four ways to change the spacings:

- Click on a value to edit it.
- Divide a row or column. Click on a row or column, then on the **Divide Row** or **Divide Column** button. Two new rows or columns will appear in the list.
- Merge rows or columns. Hold down the Shift key while clicking on each item, then click on the **Merge Rows** or **Merge Columns** button. The selected items will be combined.
- Set uniform spacing on selected rows or columns. You will be prompted to enter the number of cells you wish to create from the selected rows or columns.

Click **OK**.

For example, here, the rows and columns away from the model boundary have been divided to provide more detail. The different spacings are reflected in the scene:

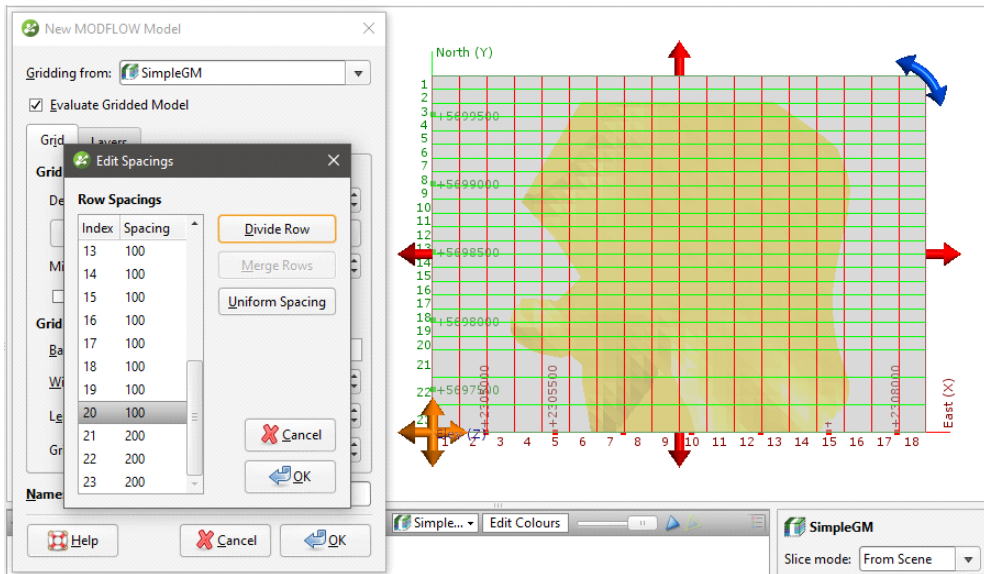

Use close spacing for step gradients and increase or decrease spacing gradually.

Vertical Grid Layering

The vertical grid layers are based on the geological model selected in the **New MODFLOW Model** window. Click on the **Layers** tab to view the layers:

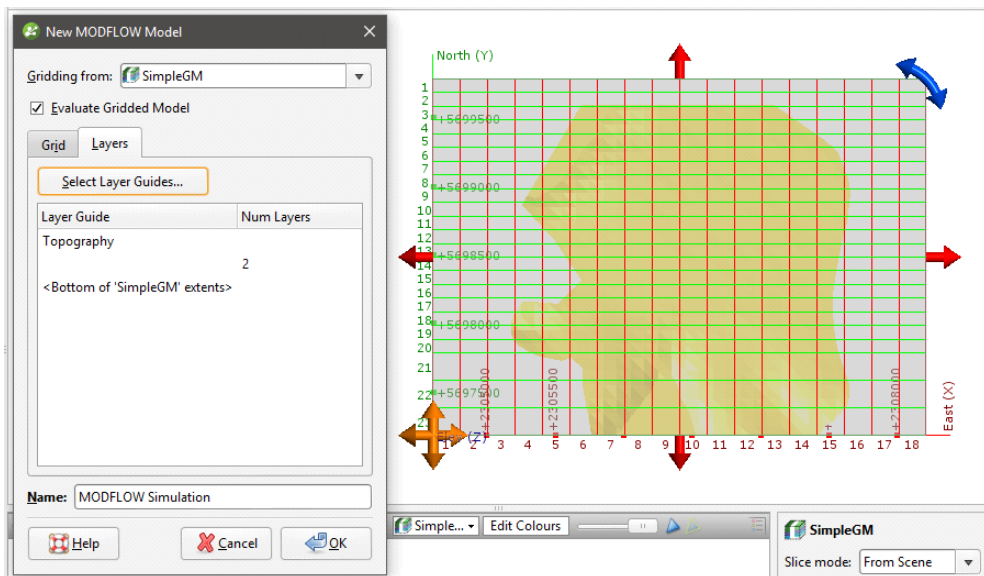

Initially, there are two layers equally spaced between the topography and the geological model. Change the layers by clicking on **Select Layer Guides** button. The **Layer Guides** window will appear, showing the layers available in the selected geological model:

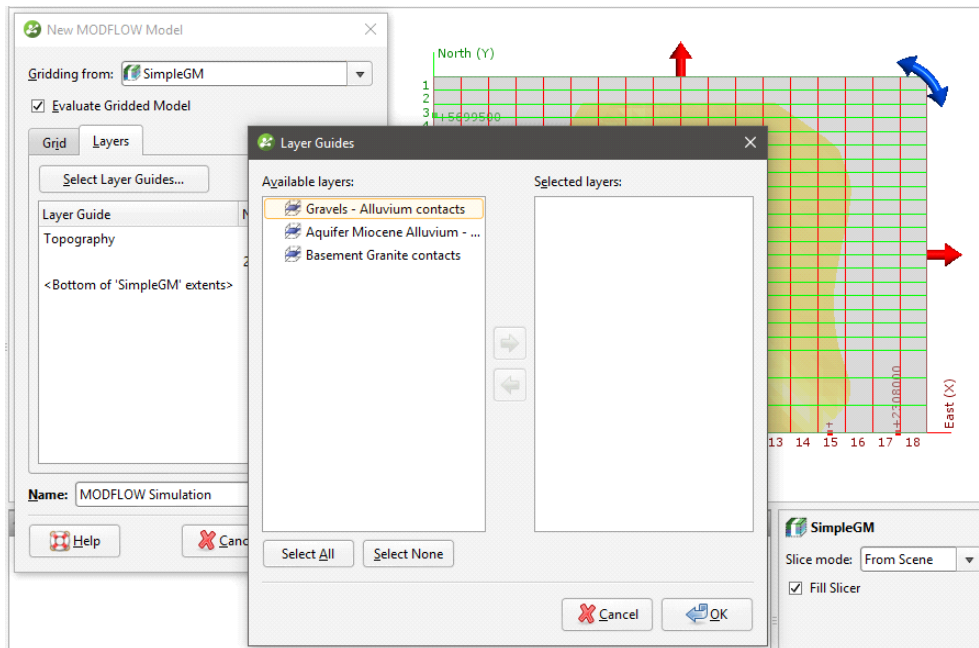

If the grid is required to follow a geological model lithology contact surface, move the layer into the **Selected** list and it will be honoured in the gridding process.

Click **OK** to return to the **New MODFLOW Model** window, in which the selected layers will be displayed:

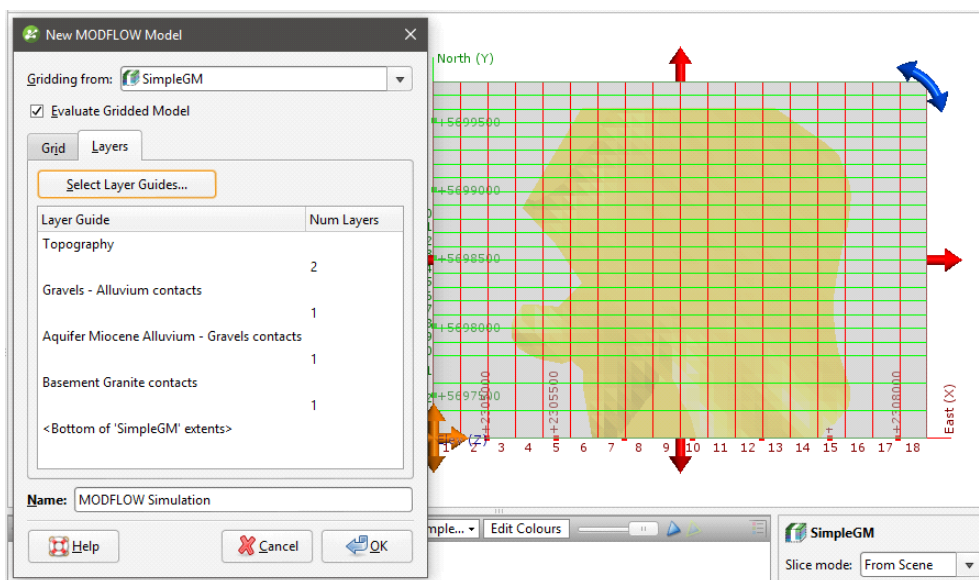

Click **OK** to create the new MODFLOW grid, which will appear in the **Flow Models** folder. You can edit the model by expanding it in the project tree and double-clicking on the grid object (🌐). See [Editing a MODFLOW Model](#).

For further information on working with the new model, see:

- [MODFLOW Model Display](#)
- [MODFLOW Evaluations](#)
- [MODFLOW Hydrological Properties](#)
- [Head Values and MT3D Concentrations](#)
- [Generating a Head Value Mesh](#)
- [MODFLOW Model Export](#)

Editing a MODFLOW Model

Once you have created a MODFLOW model, you can edit it by expanding the model in the project tree and double-clicking on the grid object (🌐). The **Edit MODFLOW Grid** window will appear. You can edit the grid spacings as described in [Creating a MODFLOW Model](#), using the information in the scene window as a guide.

Another way to edit the grid is to use the controls in the scene to apply different cell size settings in different parts of the grid. For example, you may want to define a grid that has smaller cells in the centre than at the outer edges:

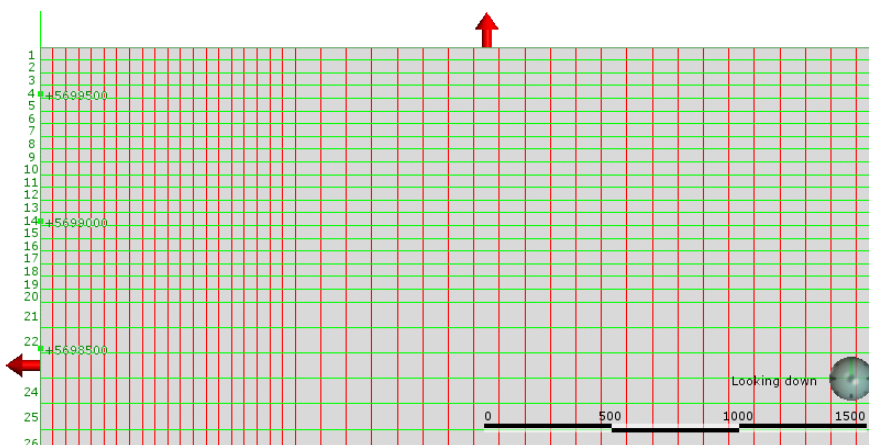

To set cell sizes in this way, it is best to start with a MODFLOW model where the **Default Cell Size** is set to the smallest cell size you will use in the model.

For this example, we will start with a new grid with a **Default Cell Size** of 50. We will set the adjacent cell size to 100 and the cell size at the outer boundary to 200.

First, we need to reduce the area that uses the cell size of 50 by using the red handles in the scene:

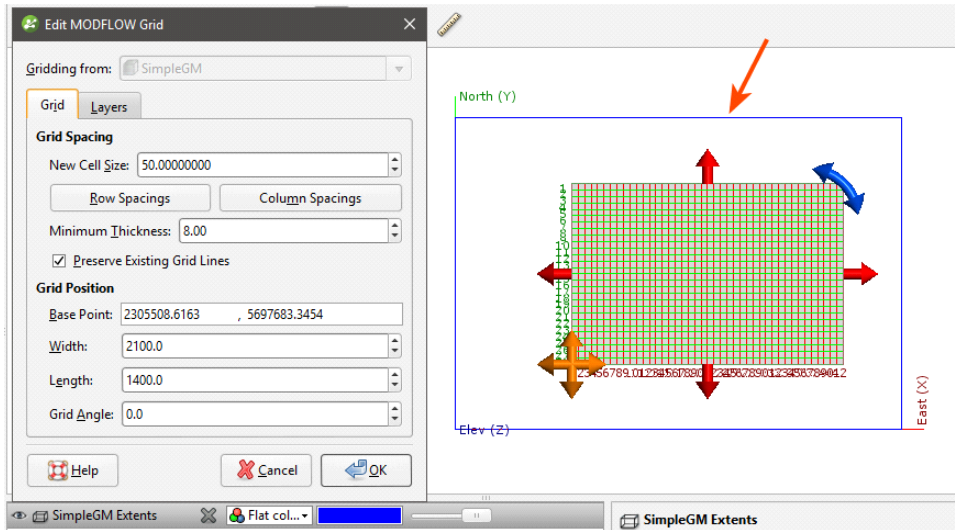

The blue box in the scene is the geological model extents for the model used to define the MODFLOW model and represents the unedited boundary of the MODFLOW model.

Next, enter the cell size to use for the area adjacent to the 50.0 cells in the **New Cell Size** field. Then, drag the red handles to enlarge the grid. The centre part of the grid is still set to 50, while the new area is set to 100:

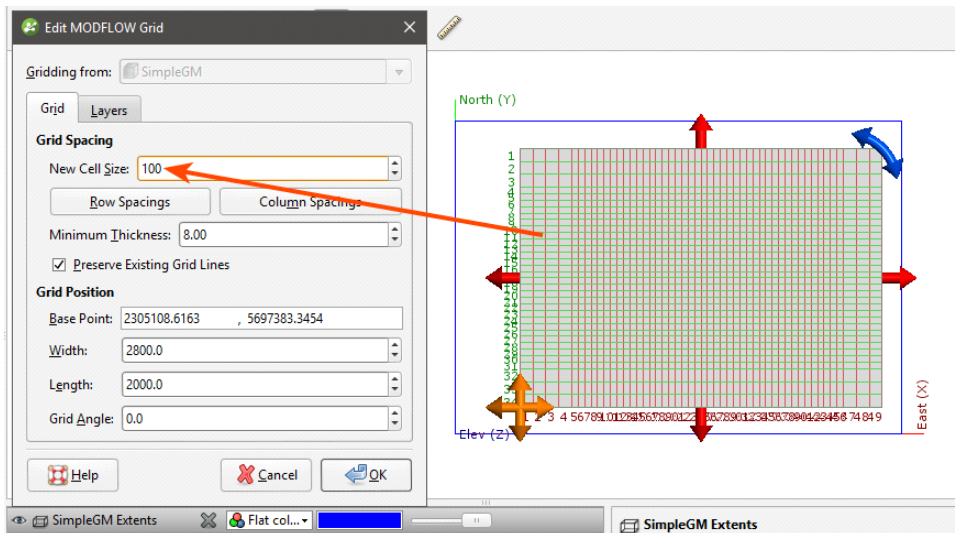

If the **Preserve Existing Grid Lines** option is enabled, grid lines for cells already defined will not be moved to account for new cells.

Enter the next cell size in the **New Cell Size** field and then use the handles to enlarge the grid again:

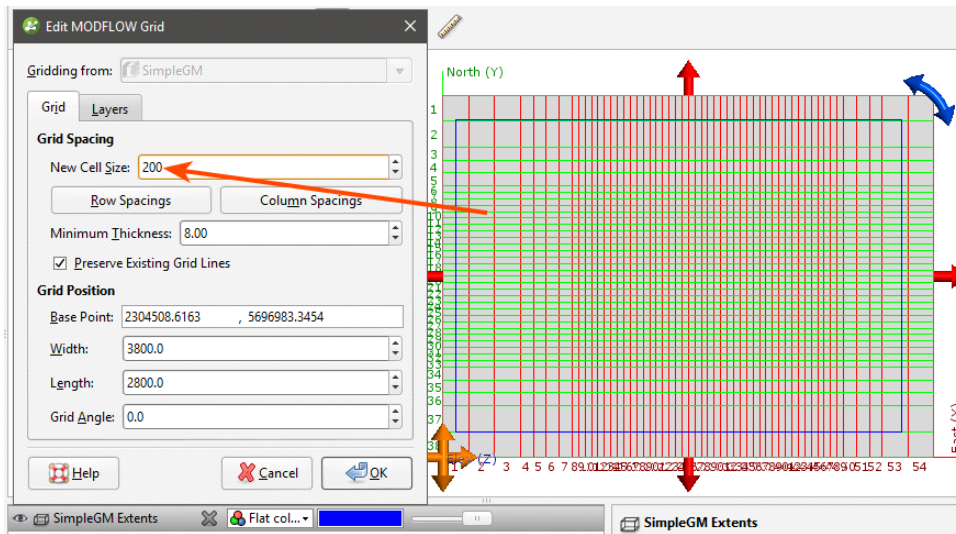

Click **OK** to update the grid.

For further information on working with the new model, see:

- [MODFLOW Model Display](#)
- [MODFLOW Evaluations](#)
- [MODFLOW Hydrological Properties](#)
- [Head Values and MT3D Concentrations](#)
- [Generating a Head Value Mesh](#)
- [MODFLOW Model Export](#)

Importing a MODFLOW Model

Leapfrog Geothermal imports .nam files and .mfi and .mfn variations of .nam files.

To import a MODFLOW model, right-click on the **Flow Models** folder and select **MODFLOW > Import Model**. Leapfrog Geothermal will ask you to specify the file location, and then will display the data in the file in the **Import MODFLOW Model** window:

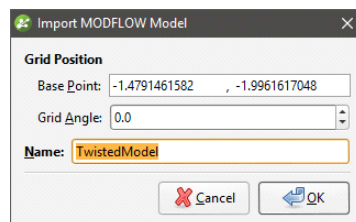

If the world origin is available, the **Grid Position** will be displayed but cannot be edited.

Click **OK** to import the grid. The new MODFLOW model will appear in the project tree in the **Flow Models** folder. See [MODFLOW Model Display](#) for information on displaying the model.

If the world origin was not available when the model was imported, you can change the **Grid Position**. To do this, expand the imported model in the project tree and double-click on its grid object (🌐).

To associate lithologies with the grid, see [MODFLOW Evaluations](#).

MODFLOW Evaluations

When a MODFLOW model is exported, the evaluated geological model is used to assign lithologies to the cells in the grid. If the grid has not been evaluated against a geological model, you must do so before you can edit the hydrological properties and before you can export the grid.

To evaluate a MODFLOW model, expand the model in the project tree, then right-click on the grid object (🌐) and select **Evaluations**. Although you can evaluate an interpolant or distance function, they cannot be exported with the grid and are simply used for displaying the grid in Leapfrog Geothermal.

A window will appear listing all objects in the project that can be used for an evaluation. Once you have selected one or more objects, click **OK**. You will then be able to select the evaluations from the view list, as described in [Evaluations](#).

Assigning an Evaluation for Export

For MODFLOW models created in Leapfrog Geothermal, the evaluation used when creating the model will automatically be assigned as the evaluation for export. A hydrological properties table (📄) will appear in the project tree as part of the model.

If the model was imported into Leapfrog Geothermal or created without being evaluated against a geological model, you will need to manually set the evaluation for export. To do this:

- Evaluate the grid against one or more geological models, as described above.
- Right-click on the model (📄 or 📄) in the project tree and select **Set Evaluation for Export**. The **Select Evaluation** window will appear showing all geological models evaluated on the grid. Select the required evaluation and click **OK**.

A hydrological properties table will be added to the model in the project tree. Edit hydrological properties by double-clicking on the table. See [MODFLOW Hydrological Properties](#).

Combined Evaluations

You can combine geological models and set the priority used for evaluation. This is useful when you have geological models available that describe different parts of the area of interest or if you have a refined geological model for part of the model. To combine geological models for evaluation, select the required models in the **Select Models To Evaluate** window, then click on the **Combined Evaluation** button.

In this example, there are three geological models selected:

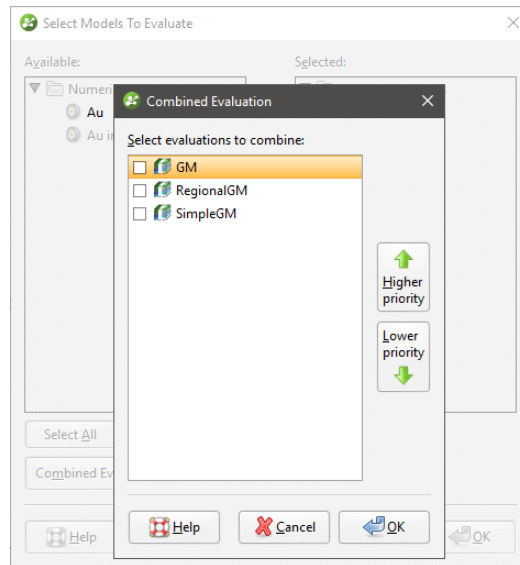

The GM and GM from contacts models describe similar areas, but GM has more detail. The GM larger model describes a larger area but with less detail. Tick the models to combine them and set their priority. Click **OK** to create the combined evaluation, then click **OK** in the **Select Models To Evaluate** window. The combined evaluation will be available from the view list and can be selected as the evaluation for export.

To delete a combined evaluation, click on the **Delete Combined** button in the **Select Models To Evaluate** window.

MODFLOW Hydrological Properties

When a MODFLOW model is evaluated against a geological model, a hydrological properties table (📄) is added to the model in the project tree. You can edit hydrological properties by double-clicking on the table. You can also open the table by right-clicking on the model in the project tree and selecting **Edit Hydrological Properties**.

If the model has been imported into Leapfrog Geothermal and has not yet been evaluated against a geological model, you will be prompted to do so. Expand the model in the project tree, right-click on the grid object and select **Evaluations**. See [MODFLOW Evaluations](#) for more information.

Hydrological properties are assigned to model blocks based on the position of the block's centroid relative to the geological model used to evaluate the grid. The position of the centroid is calculated and Leapfrog Geothermal then determines which lithology the centroid falls inside. The K values for the assigned lithology are assigned to the entire block; there is no averaging.

If more than one object has been evaluated on the grid, you can set hydrological properties separately for each evaluation. Select the required evaluation from the **Evaluation** list:

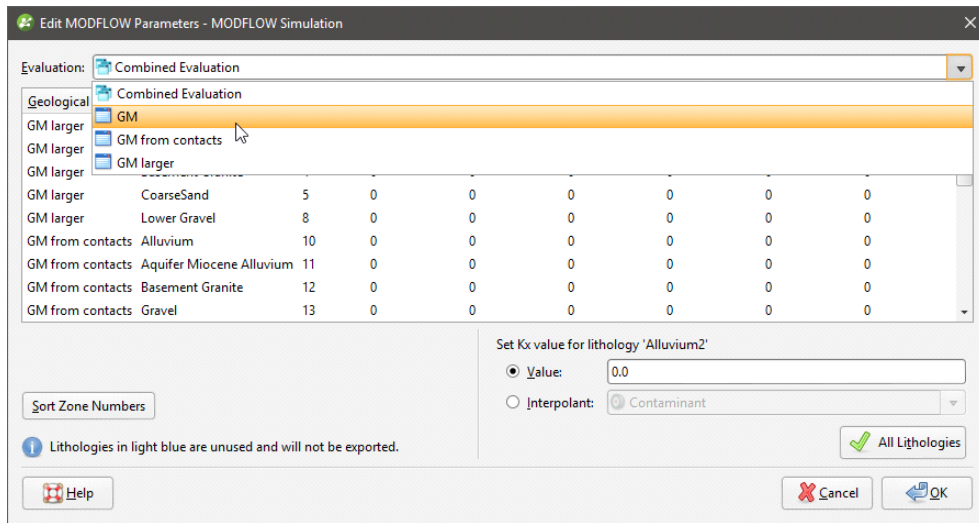

However, the only hydrological properties information that will be exported is that set for the evaluation to be exported.

Setting Hydrological Properties

In the **Edit MODFLOW Parameters** window, you can enter the values for hydrological properties manually or you can use the values from an interpolant.

To enter values manually, click on a cell, then enter the value in the **Value** field:

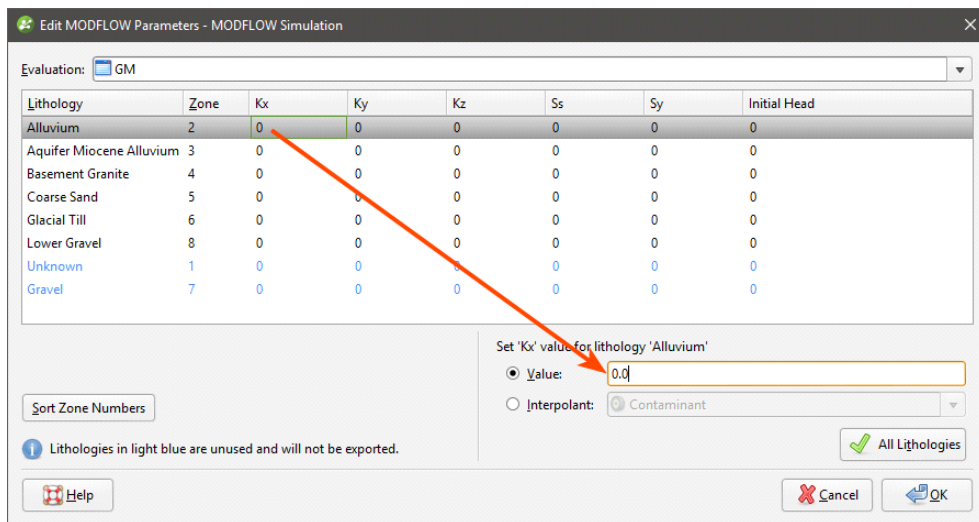

Press the Enter key to move down the columns.

To use the values from an interpolant, click the **Interpolant** button, then select an interpolant from the list. The interpolant that will be used for the selected value will be displayed in the field:

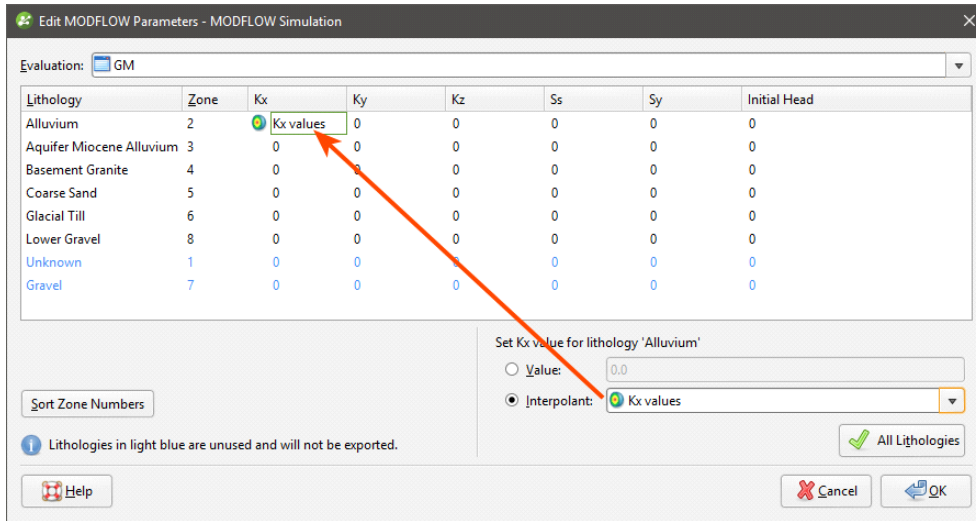

To use the interpolant for all the values in the selected column, click the **All Lithologies** button. The window will be updated to show that the interpolant values will be used for that column:

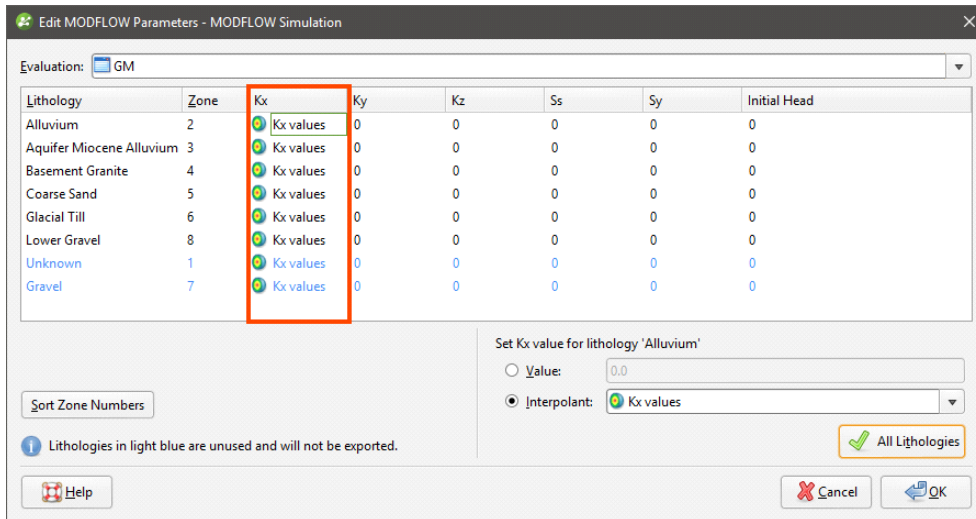

Zone Numbers

When the model is exported, the zone numbers are used to indicate the assignment of lithologies to blocks and are written to the MODFLOW zoned layer properties flow (*.lpf) file. In the **Edit MODFLOW Parameters** window, you can change the zone number for a lithology by clicking in a cell and entering a different zone number. If you reorder the zones in this way, zone number conflicts will be highlighted in red:

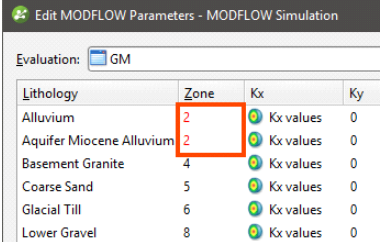

Lithology	Zone	Kx	Ky
Alluvium	2	Kx values	0
Aquifer Miocene Alluvium	2	Kx values	0
Basement Granite	4	Kx values	0
Coarse Sand	5	Kx values	0
Glacial Till	6	Kx values	0
Lower Gravel	8	Kx values	0

Zone numbers must be unique and you will not be able to close the window and save data if there are conflicts.

If you click on the **Sort Zone Numbers** button, the zone numbers will be ordered from top to bottom.

Zone numbers should not be sorted once a model has been exported as the new numbers will not be reflected in the exported model.

Click **OK** to update the grid.

MODFLOW Model Display

In the project tree, MODFLOW models are made up of a grid object (🌿), a **Simulation Outputs** folder and a hydrological properties table (📄) object. If there is no hydrological properties table, an evaluation has not yet been set for export. See [MODFLOW Evaluations](#) for more information.

For MODFLOW models created in and imported into Leapfrog Geothermal, dragging the model itself into the scene will display the grid (🌿) object. The different parts of the model can also be displayed.

Grid Display Options

Dragging a MODFLOW model into the scene displays its grid object. Here, an imported model has been evaluated against a geological model and added to the scene:

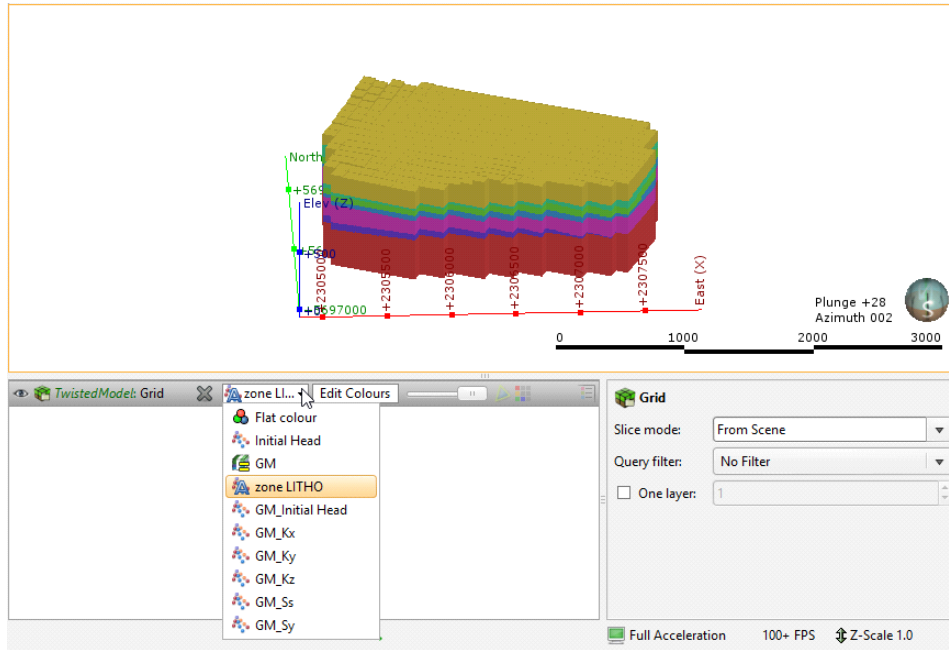

The viewing options available are the flat colour option, the evaluated geological model and zone data imported with the model. Other inputs imported with a model will also be available from this list, and once the model has been evaluated against a geological model or interpolant, you can also display the model using the grid's hydrological properties.

Grids are displayed as cells. When a geological model evaluation or lithological zone information is displayed, you can also display a legend for the grid.

When **Show edges** (🔍) is enabled, the edges of the cells will be displayed.

The **Show inactive blocks** (🔲) option displays inactive cells in grey:

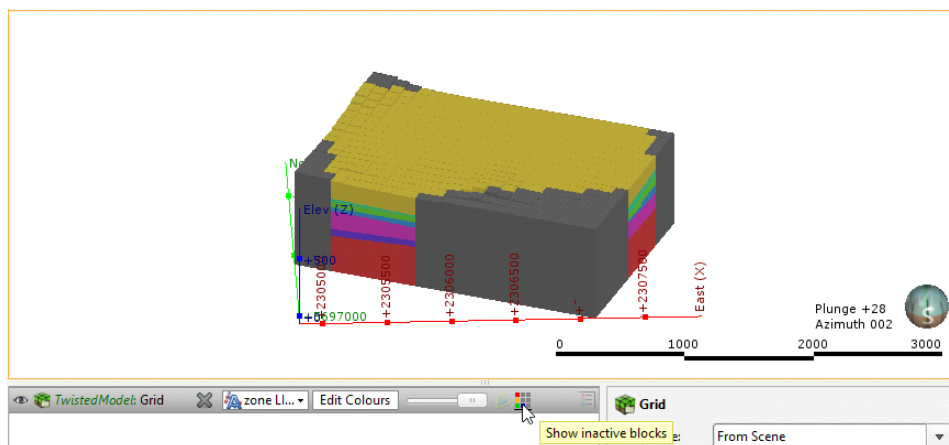

To display a single layer, tick the **One layer** box in the shape properties panel, then select the layer to display.

Head values and MT3D concentrations can also be imported and displayed. See [Head Values and MT3D Concentrations](#).

Viewing Block Information

When a MODFLOW model is displayed in the scene, you can view information about the individual cells in the model by clicking on a block. The window that appears shows information about the selected block, including its centroid and the lithology assigned to the block from the evaluated geological model. Information from all geological models and interpolants the grid has been evaluated against will be displayed:

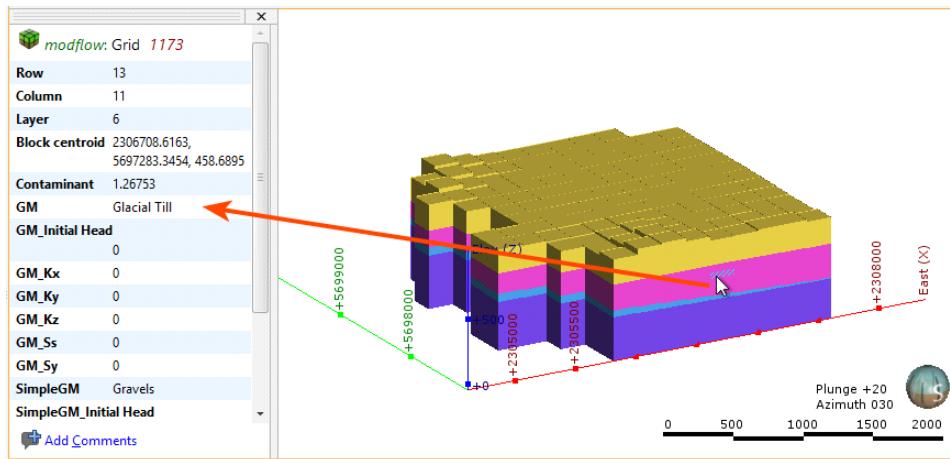

Head Values and MT3D Concentrations

Leapfrog Geothermal imports the following output file formats:

- Head values files in *.hds, *.hhd and *.hed formats
- MT3D concentrations files in *.ucn format

To import head values or MT3D concentration files for a MODFLOW model, right-click on the **Simulation Outputs** folder and select the required option. Navigate to select the file, then click **Open**.

The information will be added to the MODFLOW grid, and you can then select the head values and MT3D concentrations in the shape list when you display the grid in the scene. If the output is time-dependent, a timestep slider will be available from the shape properties panel. Click and drag the slider or click along the timeline to view the different timesteps available:

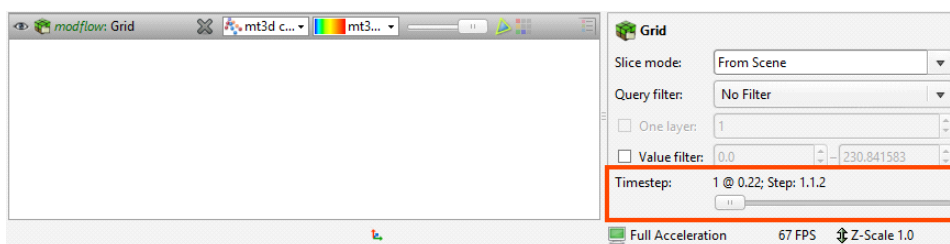

Imported head values and MT3D concentrations are stored in the project tree in the **Simulation Outputs** folder:

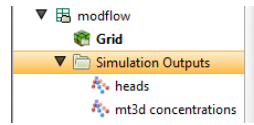

To delete head values or MT3D concentrations, right-click on the object in the project tree and select **Delete**.

Once head values have been imported, you can generate a head value mesh. See [Generating a Head Value Mesh](#).

Generating a Head Value Mesh

Once head values have been imported for a MODFLOW model, you can generate a head value mesh. To do this, expand the **Simulation Outputs** folder. Right-click on the head values object and select **Generate Head Value Mesh**. The **Generate Head Value Mesh** window will appear, showing the layers in the model and the timesteps available. Select the layer of the model you wish to generate a head value mesh for, then choose the heads. Click **OK** to create the mesh, which will be saved to the **Meshes** folder.

MODFLOW Model Export

Leapfrog Geothermal has three options for exporting MODFLOW grids:

- Export the grid as a MODFLOW file.
- Export for Groundwater Vistas. Use this option the first time you export a grid for use in Groundwater Vistas.
- Export a Groundwater Vistas update. Use this option to generate a set of files that can be imported into Groundwater Vistas as an update.

The Groundwater Vistas options include a zoned layer properties flow (*.lpf) file that includes information about the zones in the grid.

As a MODFLOW File

To export a grid as a MODFLOW file for use in a package other than Groundwater Vistas, right-click on the grid in the project tree and select **Export to MODFLOW**. You will be prompted to choose a **File name** and location. Select the options required, then click **Save**.

For Groundwater Vistas

To export a grid for use in Groundwater Vistas for the first time, right-click on the grid in the project tree and select **Export to MODFLOW for GWV**. You will be prompted to choose a **File name** and location. Select the options required, then click **Save**.

If you have previously exported the grid to Groundwater Vistas and have made changes to the grid, use the **Export to GWV Updates** option.

As a Groundwater Vistas Update

If you have exported a grid to Groundwater Vistas but then make changes to the Leapfrog Geothermal model, you can export the changes to the model. The set of files containing the changes can then be imported to Groundwater Vistas.

To export a Groundwater Vistas update, right-click on the grid in the project tree and select **Export GWV Updates**. The **Update Groundwater Vistas** window will appear listing the files that will be exported. Enter a **Base file name** to differentiate the original files from the updates. Click **Export**. The files will be saved in the specified directory.

FEFLOW Models

In Leapfrog Geothermal, creating a 3D FEFLOW model requires:

- A geological model that will be used to assign lithologies to the FEFLOW model's blocks.
- A 2D grid that defines the block size, boundaries and surface features.

Steps for creating a 3D FEFLOW model that can be exported and run outside Leapfrog Geothermal are:

1. Create a geological model.
2. Create and refine a 2D model in Leapfrog Geothermal or import a FEFLOW model.
3. Create the 3D model from the 2D model or another 3D model in the project.
4. Evaluate the new 3D model against a geological model.
5. Edit the material types.
6. Export the 3D FEFLOW model.

Once the model has been processed outside of Leapfrog Geothermal, a results file can be saved that can be imported into Leapfrog Geothermal and visualised in the scene.

A 2D grid can be created in or imported into Leapfrog Geothermal. A 3D grid can also be used, in which case the layer information is not used in creating the 3D grid. Creating the 2D grid in Leapfrog Geothermal provides the most flexibility, as the block sizes can easily be changed, the boundaries modified and features added to provide finer resolution where there is more data available.

For information about creating 2D and 3D grids, see [Creating a 2D FEFLOW Model](#) and [Creating a 3D FEFLOW Model](#).

You can also import FEFLOW problem files and result files, visualise them in Leapfrog Geothermal and use them as the basis for new models. See [Importing a FEFLOW Grid](#).

See [FEFLOW Model Display](#) for information on options for displaying FEFLOW models in the scene.

3D grids created in Leapfrog Geothermal can be evaluated against a geological model when they are created. Grids imported into Leapfrog Geothermal or that were not evaluated when they were created can be evaluated as described in [FEFLOW Evaluations](#).

Once a model has been defined and evaluated against a geological model, material types can be assigned and the grid can be exported. See [FEFLOW Material Types](#) and [FEFLOW Model Export](#).

FEFLOW Model Display

In the project tree, 3D FEFLOW models are made up of a grid object representing the finite elements, a nodes object and a material types table (GM) object. If there is no material types table, an evaluation has not yet been set for export. See [FEFLOW Evaluations](#) for more information.

A 2D FEFLOW grid is made up of a grid object and a nodes object. Here, three types of FEFLOW models are shown expanded in the project tree:

- Feflow 3D Simulation is a 3D model created in Leapfrog Geothermal.
- Feflow 2D Simulation is a 2D model created in Leapfrog Geothermal.
- Feflow Results is an imported 3D model (DAC file).

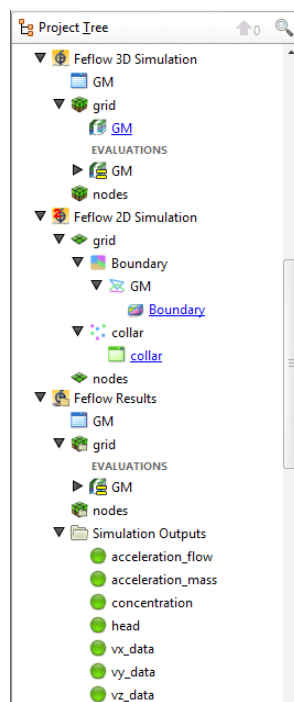

From the information in the project tree, we can see that:

- The 3D simulation created in Leapfrog Geothermal (🌍) uses the GM geological model to define the layers.
- The 2D simulation created in Leapfrog Geothermal (🌍) uses the GM geological model as a boundary and has had collar points added as a feature.
- The imported results model (📄) includes a number of simulation outputs.

For each type of FEFLOW model, dragging the model itself into the scene will display the grid (🌍) object. The different parts of the model can also be displayed.

Displaying a 3D Model

Dragging a 3D simulation into the scene displays its grid object, which represents the finite elements. Here, a 3D model created in Leapfrog Geothermal (🦊) has been added to the scene:

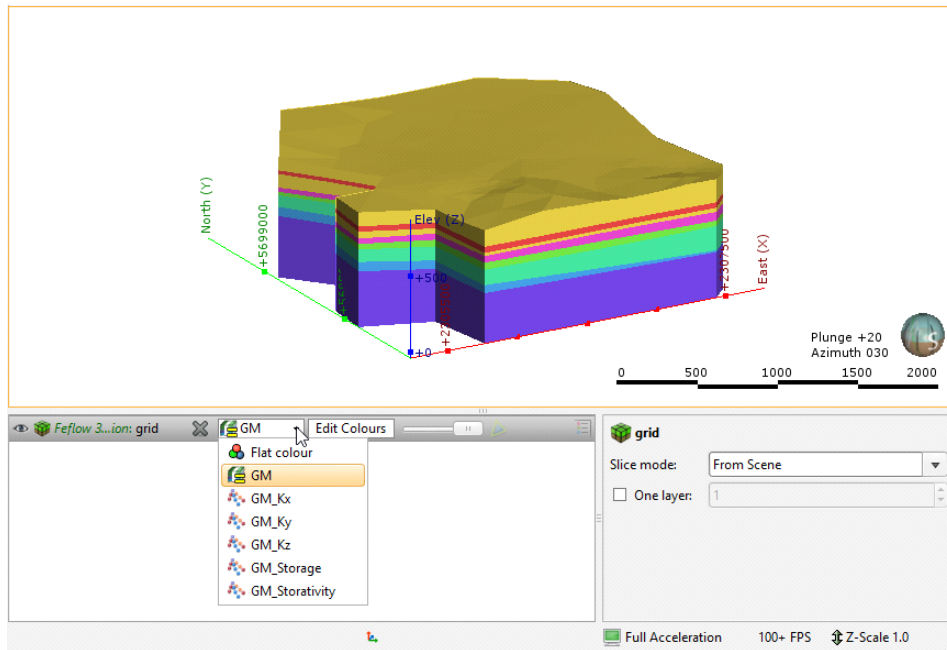

For 3D models imported into Leapfrog Geothermal, you can display the model using other information available for the grid, such as conductivity data. This is available from the view list.

Grids for 3D models are displayed as blocks. You can also display a legend for the grid when a geological model evaluation is displayed.

When **Show edges** (🔍) is enabled, the edges of the blocks will be displayed.

To display a single layer, tick the **One layer** box in the shape properties panel, then select the layer to display.

You can display the nodes by adding the nodes (🟢) object to the scene. When a model with results is displayed, the simulation outputs can be displayed when the nodes are viewed in the scene. Here, the nodes for an imported results file have been added to the scene. The heads are displayed for a single layer:

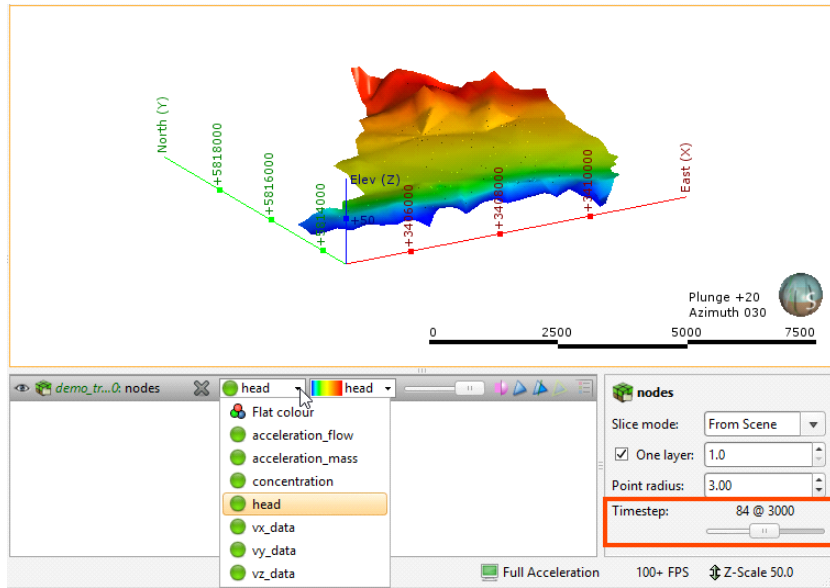

When the results are time-dependent, a timestep slider will be available from the shape properties panel. Click and drag the slider or click along the timeline to view the different timesteps available.

Displaying a 2D Model

As with 3D models, dragging a 2D model into the scene displays its grid object. Here, a 2D model created in Leapfrog Geothermal (🟡) has been added to the scene and viewed from above:

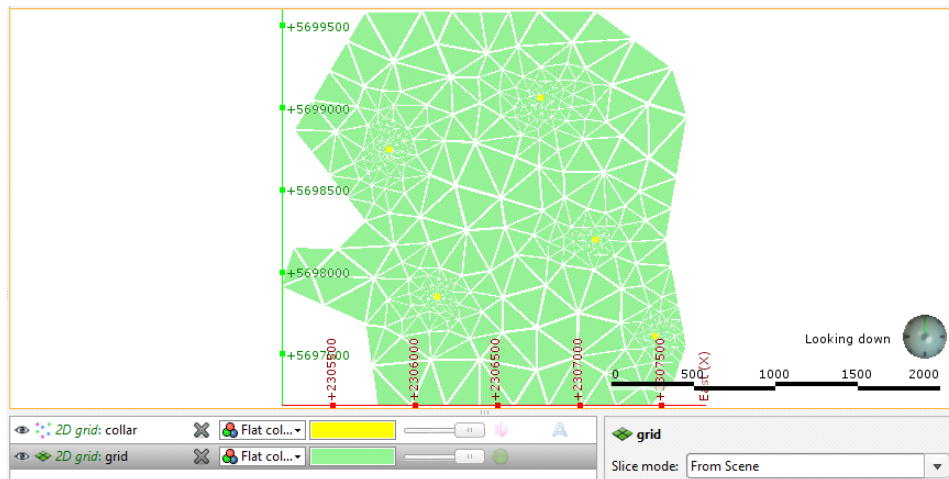

Also in the scene is a collar points object that shows collar points that have been added to the grid as a feature.

2D grids can be viewed as points or as blocks. As with imported 3D grids, an imported 2D grid can also be displayed using other information available for the grid.

Other viewing options are available for 2D grids created in Leapfrog Geothermal. These are useful in refining a 2D grid and are described in [Creating a 2D FEFLOW Model](#).

Viewing Block Information

When a FEFLOW model is displayed in the scene, you can view information about the individual blocks in the model by clicking on a block. The window that appears shows information about the selected block, including its centroid and the lithology assigned to the block from all evaluated geological models and interpolants:

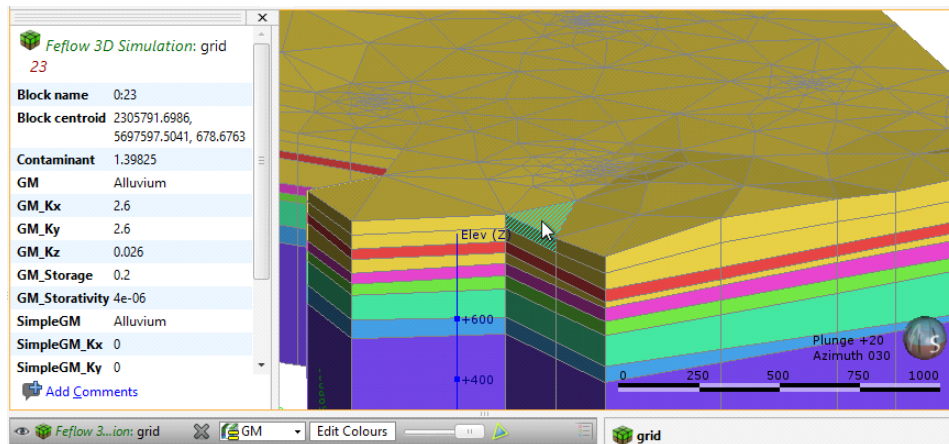

Information from all geological models and interpolants the grid has been evaluated against will be displayed:

Importing a FEFLOW Grid

You can import 2D and 3D FEFLOW grids and use them as the basis for new models. Leapfrog Geothermal imports two types of FEFLOW files:

- FEFLOW problem files (*.fem) in ASCII format. Importing these files results in a new 2D or 3D model with a grid and nodes.
- FEFLOW results files (*.dac). Importing these files results in a new 3D model with a grid, nodes and simulation outputs.

To import a FEFLOW grid or results file, right-click on the **Flow Models** folder and select one of the **FEFLOW > Import** options. Leapfrog Geothermal will ask you to specify the file location. Click **Open** to import the file.

The new FEFLOW grid will appear in the project tree under the **Flow Models** folder. To use the imported grid or results file as the basis for a new FEFLOW model, see [Creating a 3D FEFLOW Model](#).

To associate lithologies with a 3D grid, see [FEFLOW Material Types](#).

See [FEFLOW Model Display](#) for information about displaying the FEFLOW grid in the scene window.

Creating a 2D FEFLOW Model

A 2D FEFLOW model defines the block size, boundaries and surface features for a 3D FEFLOW model. Although existing 2D grids can be imported into Leapfrog Geothermal and used for creating 3D models, creating the 2D grid in Leapfrog Geothermal provides the most flexibility, as the block sizes can easily be changed, the boundaries modified and features added to provide finer resolution where there is more data available.

It is not necessary to create a geological model before creating a 2D grid. However, you will not be able to create a 3D grid until a geological model has been created. Therefore, it is a good idea to create the geological model first, and its dimensions can be used in defining the boundary of the 2D grid.

To create a 2D grid, right-click on the **Flow Models** folder and select **FEFLOW > New 2D Model**. The **New 2D FEFLOW Grid** window will appear:

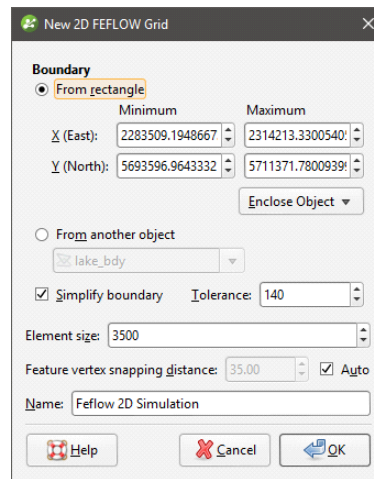

All settings can be changed once the grid has been created. It is, therefore, reasonable to accept the default settings and create the grid, then add it to the scene and begin refining it. Click **OK** to create the initial grid.

In the project tree, a 2D FEFLOW grid is made up of a grid object and a nodes object, as described in [FEFLOW Model Display](#). Here, a newly-created grid with a rectangular boundary appears in the project tree:

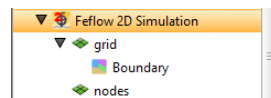

Expand the grid in the project tree and double-click on the grid object (◆) to open the **Edit 2D FEFLOW Grid** window. The **Features** tab will be displayed. When a grid is first created, this window will be empty, but once features have been added, you can enable them in this tab.

Click on the **Boundary** tab to modify the boundary:

Click the **Apply** button to view the effect of changes made without closing this window.

Boundary Options

When setting the **Boundary**, you can set a rectangular boundary defined by the **From rectangle** settings. You can use the extents of any other object in the project by selecting from the **Enclose Object** list, but the grid boundary will always be a rectangle.

To define a non-rectangular boundary, use the **From another object** options and select from the list of objects available in the project. This is useful if, for example, you wish to define a grid using the boundary of a geological model.

The **Simplify boundary** option reduces the number of points along the boundary. Reducing the **Tolerance** value increases the number of points along the boundary. The two settings together let you define a basic boundary with elements that are roughly uniform in size, set by the value of **Element size**. Here, a grid has been created from a geological model with the **Simplify boundary** option enabled:

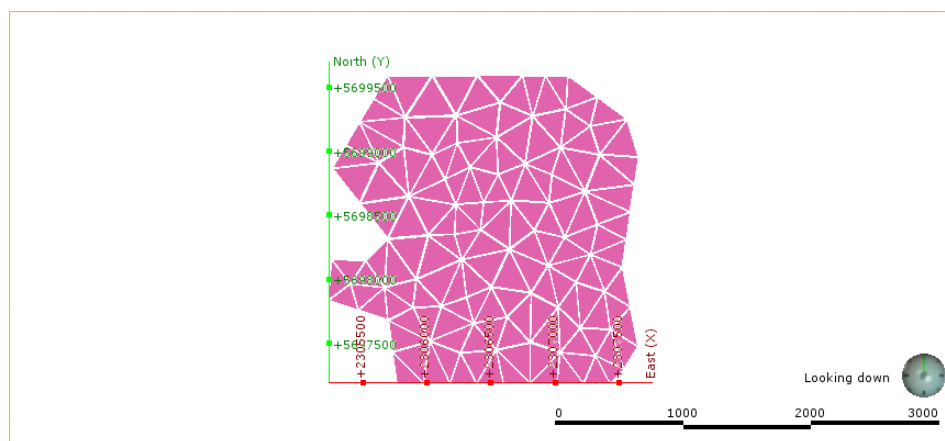

Disabling the **Simplify boundary** option results in more detail around the edges of the grid:

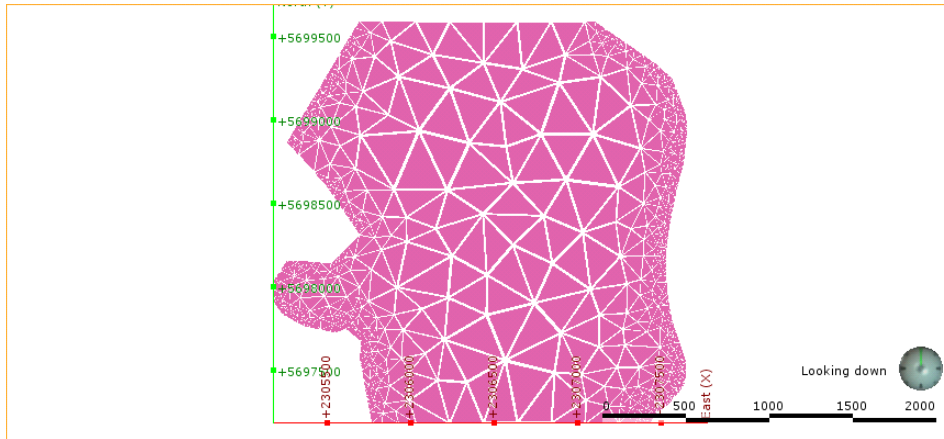

Element Size

The **Element size** setting determines the basic size of the triangles that make up the grid, although the size will vary according to features applied to the grid and the **Feature vertex snapping distance**. The size will also vary if the **Simplify boundary** option is unticked, in which case the **Element size** setting is the maximum size of the triangles.

The **Feature vertex snapping distance** is automatically set to 1 percent of the **Element size**. To use a smaller snapping distance, untick the **Auto** box and set the value required.

The effects of the **Feature vertex snapping distance** do not become apparent until features have been added to the grid.

Adding Features to the Grid

To add features to the grid, right-click on the grid in the project tree and select **New Feature**. The **New FEFLOW Feature** window will appear:

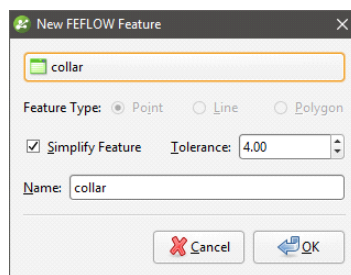

You can add **Point**, **Line** and **Polygon** features, and the **Feature Object** list will display all suitable objects available in the project. Ticking the **Simplify Feature** option will reduce the number of points used.

Click **OK** to add the feature, which will appear in the project tree under the FEFLOW grid object:

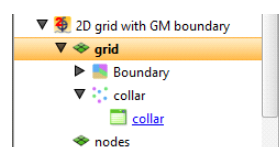

You can edit the feature by double-clicking on it or by right-clicking and selecting **Open**. However, the feature has not yet been applied to the grid. To enable the feature, double-click on the grid to open the **Edit 2D FEFLOW Grid** window. Tick the box to enable the feature, then adjust the number of **Refinement Steps**:

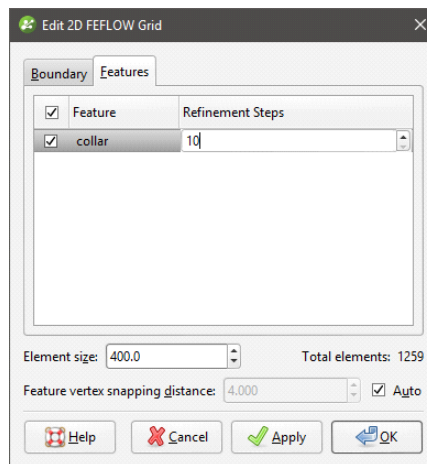

More **Refinement Steps** will produce more detail near the feature.

Click **Apply** or **OK** to view the effect the feature and its settings have on the grid.

If you want to modify a feature without having to reprocess the grid, untick it in the **Features** tab. If you want to delete a feature, right-click on it in the project tree and select **Delete**.

The images below show a grid displayed with collar points (in red) to demonstrate the effects of no features and collars applied with different refinement steps:

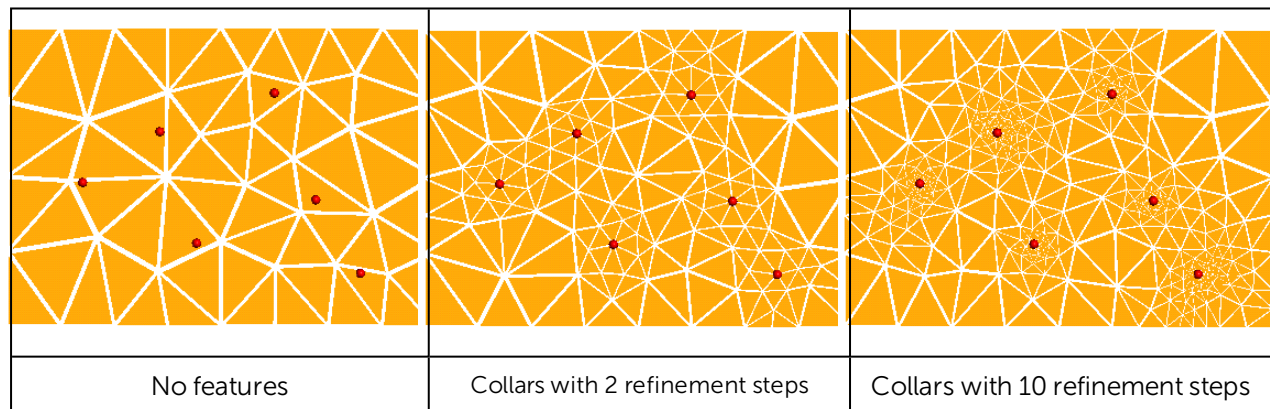

To view all features added to a grid, right-click on the grid and select **View Snapped Features**. A **Snapped Features** object will appear in the shape list that represents all objects used to add features to the grid:

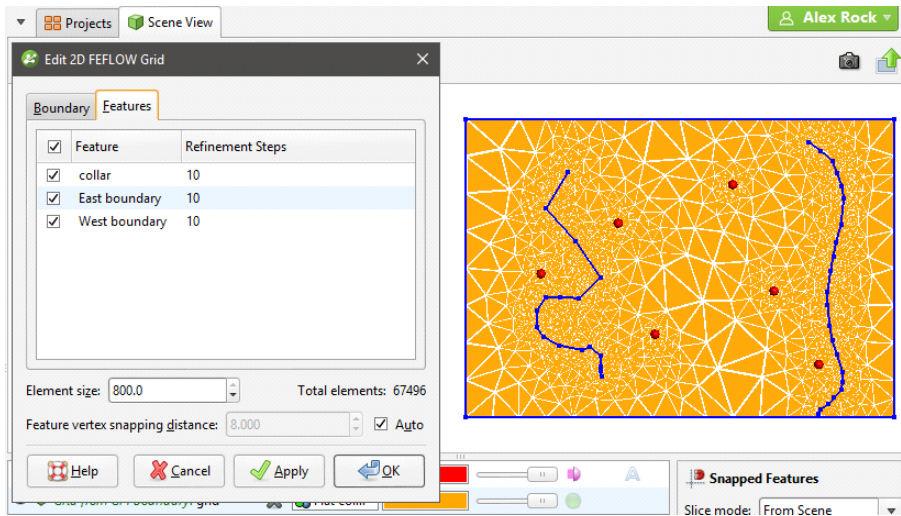

Here, four snapped objects appear in the scene: the three features listed in the **Features** tab and the grid's boundary.

See [Creating a 3D FEFLOW Model](#) for information on using the 2D grid as the basis for a 3D model.

Creating a 3D FEFLOW Model

To create a new 3D FEFLOW model, you must first create or import a 2D FEFLOW grid as described in [Creating a 2D FEFLOW Model](#) and [Importing a FEFLOW Grid](#).

Once you have created or imported a 2D FEFLOW grid, right-click on the **Flow Models** folder and select **FEFLOW > New 3D Model**. The **Extrude 3D FEFLOW Grid** window will appear:

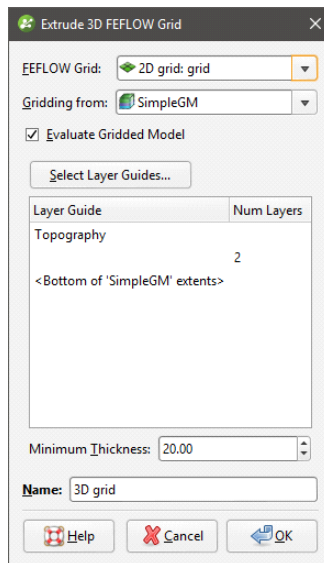

The dimensions and resolution of the grid are set by the 2D or 3D grid selected from the **FEFLOW Grid** list. See [Creating a 2D FEFLOW Model](#) for information on creating and refining a 2D grid that can be used as the basis for a 3D grid.

The **Gridding from** setting determines the geological model used for layer guides. Ticking the **Evaluate Gridded Model** box will evaluate the new 3D model against the selected geological model and set it as the evaluation for export. See [FEFLOW Evaluations](#) for more information. If you do not wish to evaluate the geological model on the grid, untick the box. You will still be able to use the layers in the geological model to control the grid layers.

The FEFLOW grid is initially made up of two layers equally spaced between the topography and the geological model, with the minimum thickness of each layer determined by the **Minimum Thickness** setting. You can add layers to the grid by clicking on the **Select Layer Guides** button and then selecting from the layers available in the geological model:

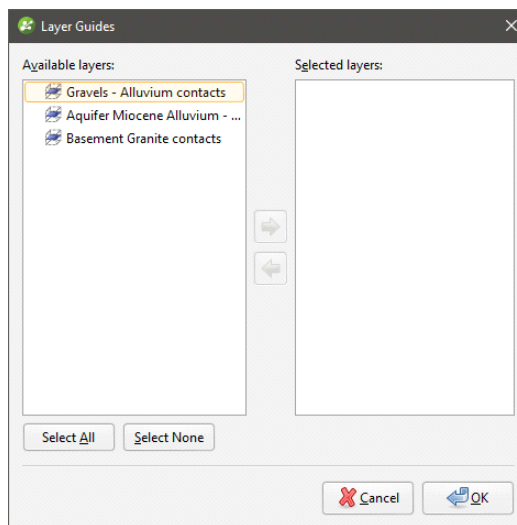

If the grid is required to follow a geological model lithology contact surface, move the layer into the **Selected** list and it will be honoured in the gridding process.

Click **OK** to return to the **Extrude 3D FEFLOW Grid** window. The selected layers will be displayed:

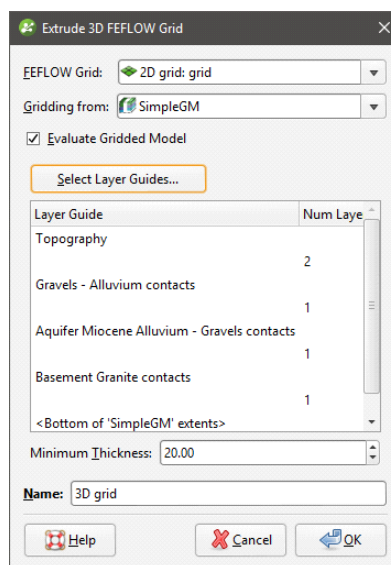

Click **OK** to generate the new FEFLOW grid, which will appear in the project tree under the **Flow Models** folder.

Once the model has been created, you can edit it by expanding the model in the project tree and double-clicking on its grid object. The layer guides selected, the number defined and the **Minimum Thickness** can be modified, but the FEFLOW grid on which the model is based and the geological model used for gridding cannot be changed.

The boundaries of the selected geological model must be larger than the FEFLOW grid used as the basis for the new model. If this is not the case, you can change the geological model's extents so that they enclose the FEFLOW grid.

For further information on working with the new grid, see:

- [FEFLOW Model Display](#)
- [FEFLOW Evaluations](#)
- [FEFLOW Material Types](#)
- [FEFLOW Model Export](#)

FEFLOW Evaluations

When a 3D FEFLOW model is exported, the evaluated geological model is used to assign lithologies to the blocks in the grid. If the grid has not been evaluated against a geological model, you must do so before you can edit the material types and before you can export the grid.

To evaluate a FEFLOW grid, expand the model in the project tree. Right-click on the grid object (🌐) and select **Evaluations**. Although you can evaluate an interpolant or distance function, they cannot be exported with the grid and are simply used for displaying the grid in Leapfrog Geothermal.

A window will appear listing all objects in the project that can be used for an evaluation. Once you have selected one or more objects, click **OK**. You will then be able to select the evaluations from the view list, as described in [Evaluations](#).

Assigning an Evaluation for Export

For 3D grids created in Leapfrog Geothermal, the evaluation used when creating the grid will automatically be assigned as the evaluation for export. A material types table (📄) will appear in the project tree as part of the 3D grid.

If the grid was imported into Leapfrog Geothermal or created without being evaluated against a geological model, you will need to manually set the evaluation for export. To do this:

- Evaluate the grid against one or more geological models, as described above.
- Right-click on the model (🌐 or 📄) in the project tree and select **Set Evaluation for Export**. The **Select Evaluation** window will appear showing all geological models evaluated on the grid. Select the required evaluation and click **OK**.

A material types table will be added to the FEFLOW grid in the project tree. Edit material types by double-clicking on the table. See [FEFLOW Material Types](#).

Combined Evaluations

You can combine geological models and set the priority used for evaluation. This is useful when you have geological models available that describe different parts of the area of interest or if you have a refined geological model for part of the model. To combine geological models for evaluation, select the required models in the **Select Models To Evaluate** window, then click on the **Combined Evaluation** button.

In this example, there are three geological models selected:

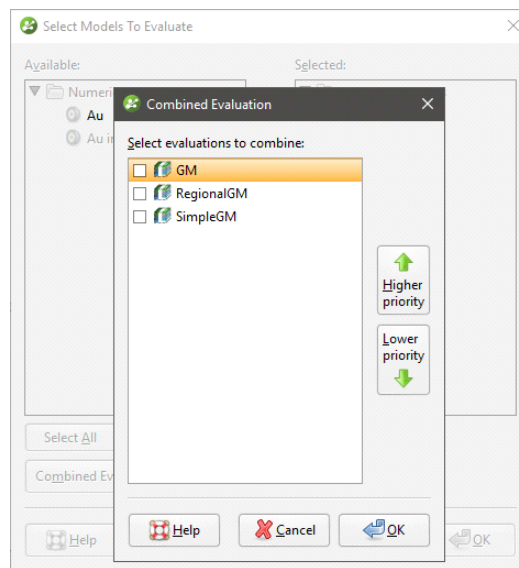

The GM and GM from contacts models describe similar areas, but GM has more detail. The GM larger model describes a larger area but with less detail. Tick the models to combine them and set their priority. Click **OK** to create the combined evaluation, then click **OK** in the **Select Models To Evaluate** window. The combined evaluation will be available from the view list and can be selected as the evaluation for export.

To delete a combined evaluation, click on the **Delete Combined** button in the **Select Models To Evaluate** window.

FEFLOW Material Types

When a FEFLOW model is first evaluated against a geological model, a material types table (📄) is added to the FEFLOW grid in the project tree. You can edit material types by double-clicking on the table. You can also open the table by right-clicking on the grid and selecting **Edit Material Types**.

If the grid has been imported into Leapfrog Geothermal and has not yet been evaluated against a geological model, you will be prompted to do so. Expand the model in the project tree, right-click on the grid object and select **Evaluate Geological Model**. See [FEFLOW Evaluations](#) for more information.

If more than one object has been evaluated on the grid, you can set material types separately for each evaluation. Select the required evaluation from the **Evaluation** list:

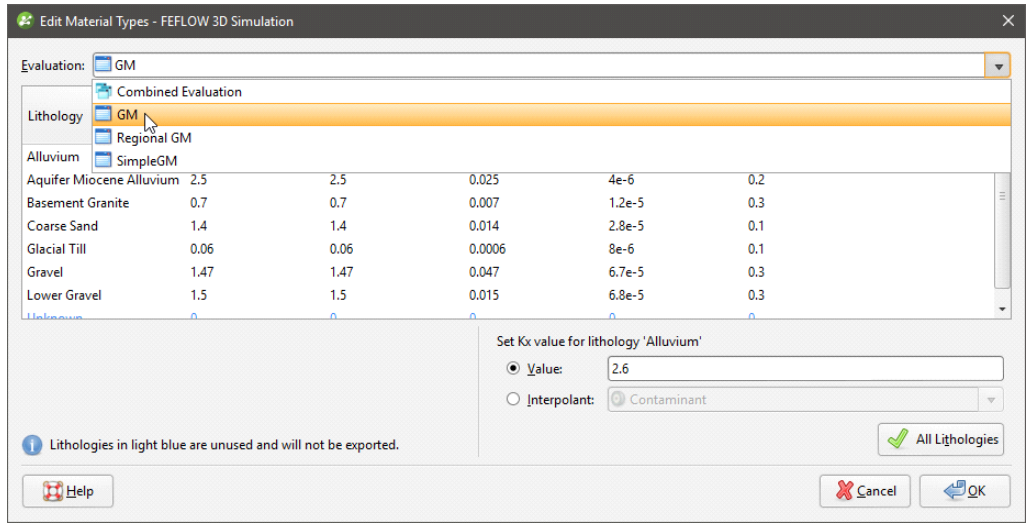

However, the only material types information that will be exported is that set for the evaluation to be exported.

In the **Edit Material Types** window, you can enter the values for material types manually or you can use the values from an interpolant.

To enter values manually, click on a cell, then enter the value in the **Value** field:

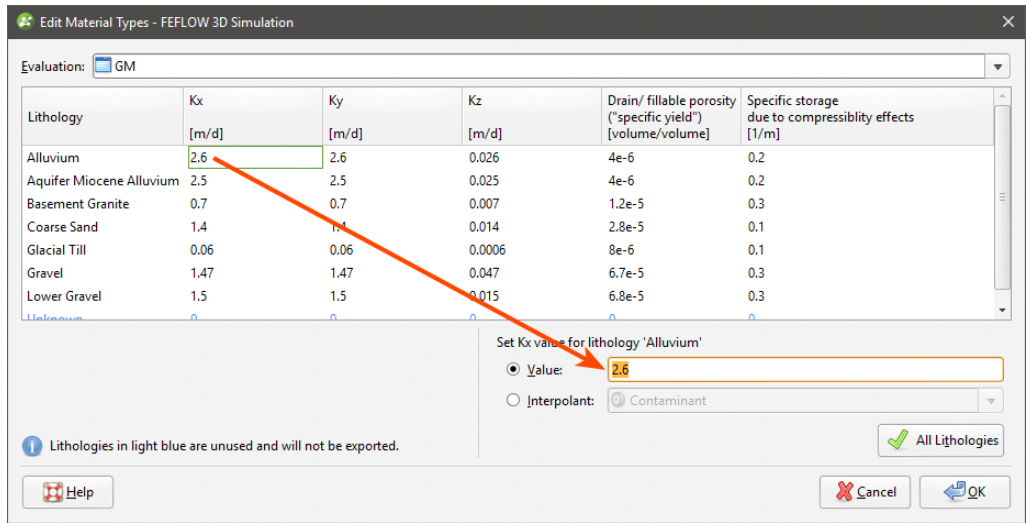

Press the Enter key to move down the columns.

To use the values from an interpolant, click the **Interpolant** button, then select an interpolant from the list. The interpolant that will be used for the selected value will be displayed in the field:

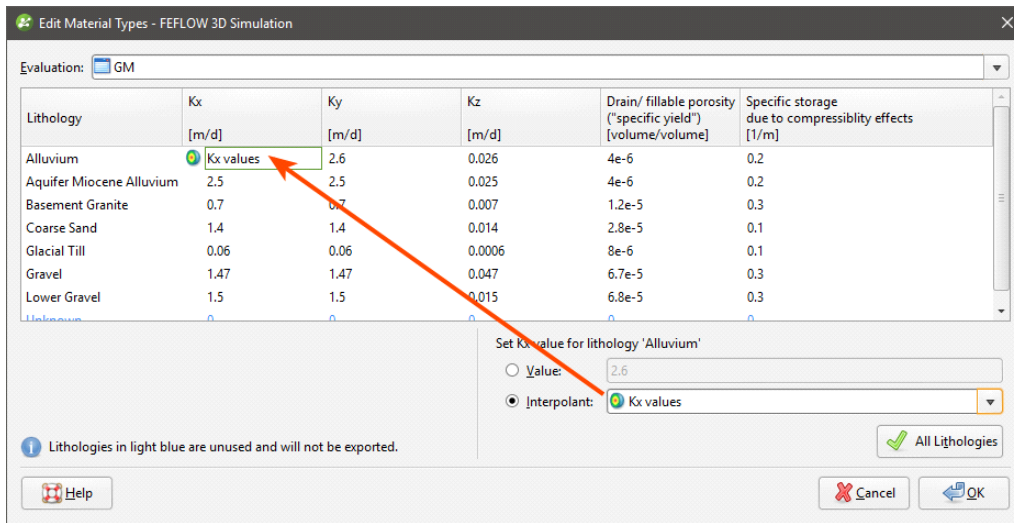

To use the interpolant for all the values in the selected column, click the **All Lithologies** button. The window will be updated to show that the interpolant values will be used for that column:

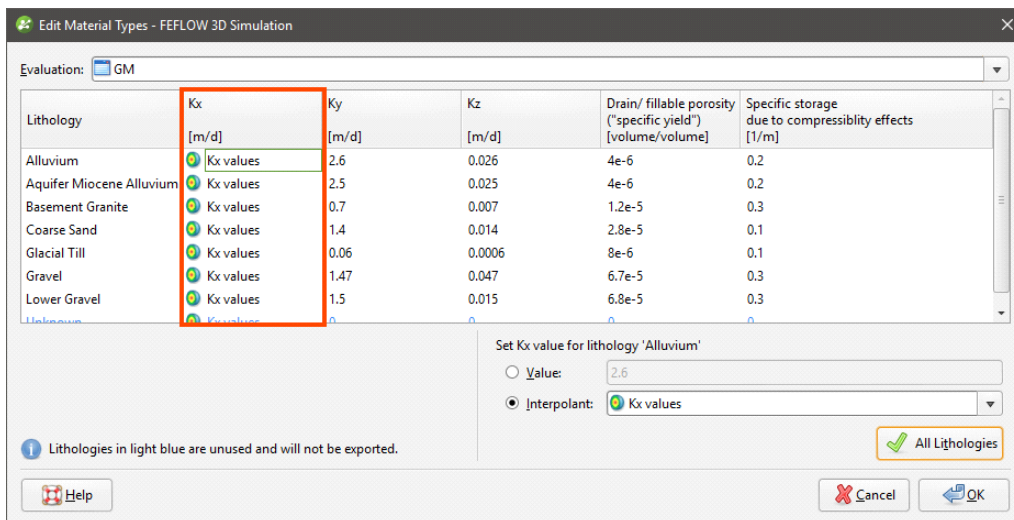

Click **OK** to update the grid.

FEFLOW Model Export

To export a 3D FEFLOW model as an ASCII format FEFLOW file (*.fem), right-click on the grid in the project tree and select **Export To FEFLOW**. You will be prompted to choose a **File name** and location. Select the options required, then click **Save**.

2D FEFLOW grids cannot be exported.

TOUGH2 Models

In Leapfrog Geothermal, you can create, import and visualise TOUGH2 simulations, inputs and outputs. You can also generate rocktypes, faulted and unfaulted, from a geological model or combined in the project and export block lithologies and TOUGH2 inputs. When creating TOUGH2 models in Leapfrog Geothermal, you can create structured or unstructured grids.

The rest of this topic describes working with TOUGH2 models in Leapfrog Geothermal. It is divided into:

- [Structured TOUGH2 Models](#)
- [Unstructured TOUGH2 Models](#)
- [Importing TOUGH2 Models](#)
- [Displaying TOUGH2 Models](#)
- [Editing TOUGH2 Grid Parameters](#)
- [Editing Rock Type Properties](#)
- [Evaluating a Faulted Model](#)
- [Copying a TOUGH2 Model](#)
- [Creating a Static Copy of a TOUGH2 Model](#)
- [Exporting TOUGH2 Models](#)

Structured TOUGH2 Models

To create a new structured TOUGH2 model, you must first have at least one geological model defined in the project.

To create a structured TOUGH2 model, right-click on the **Flow Models** folder and select **TOUGH2 > New Structured Model**. The **New TOUGH2 Grid** window will appear, together with controls in the scene that will help you define the model:

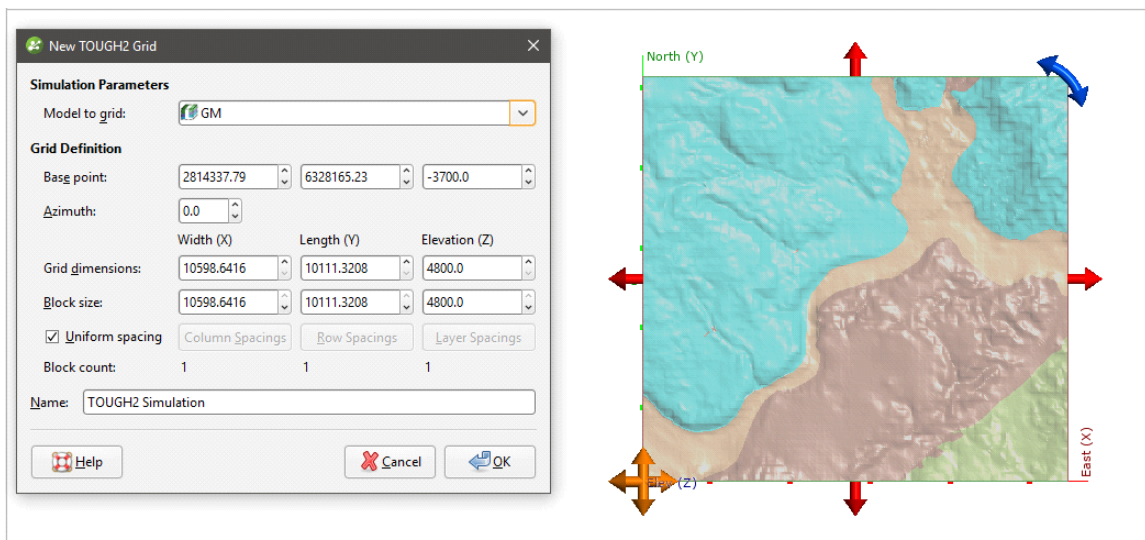

A geological model or a combined model can be used for the initial grid dimensions. Select the model required from the **Model to grid** list and set the dimensions of the grid.

Once you have created a new TOUGH2 model, you cannot change what model is used as the basis for the grid.

The scene will be updated to reflect changes you make in the **New TOUGH2 Grid** window.

The model should be slightly smaller than the selected model. Any TOUGH2 blocks that exist outside the model will be marked as inactive when the model is exported.

The default **Block Count** is 1x1x1. To use different block spacing, untick the **Uniform Spacing** box and then click the **Spacings** buttons to change the number of blocks. In the **Edit Spacings** window, you can select multiple spacings by holding down the Shift key while clicking on each item.

There are four ways to change the spacings:

- Click on a value to edit it.
- Divide a row or column. Click on a row or column, then on the **Divide Row** or **Divide Column** button. Two new rows or columns will appear in the list.
- Merge rows or columns. Hold down the Shift key while clicking on each item, then click on the **Merge Rows** or **Merge Columns** button. The selected items will be combined.
- Set uniform spacing on selected rows or columns. You will be prompted to enter the number of cells you wish to create from the selected rows or columns.

Click **OK**.

Here the **Column Spacings** have been set to 10 cells uniformly spaced:

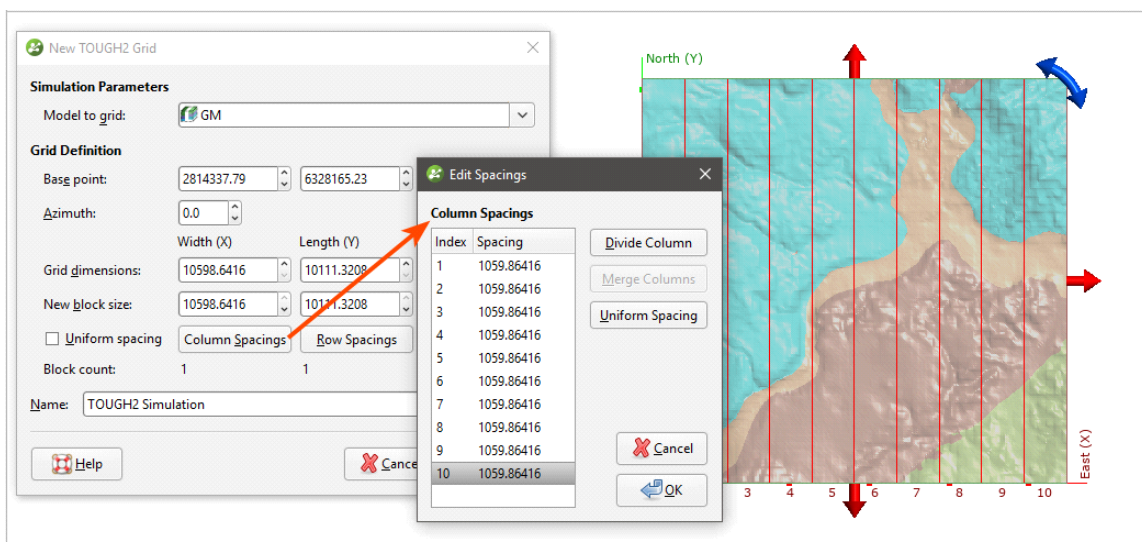

Click **OK** to create the model, which will appear in the project tree under the **Flow Models** folder. You can then change parameters for the model, load inputs and outputs, edit rocktype information and export block lithologies.

Unstructured TOUGH2 Models

To create a new unstructured TOUGH2 model, you must first have at least one geological model defined in the project.

To create an unstructured TOUGH2 model, right-click on the **Flow Models** folder and select **TOUGH2 > New Unstructured Model**. The **New Unstructured TOUGH2 Model** window will appear, together with controls in the scene that will help you define the top and depth of the grid:

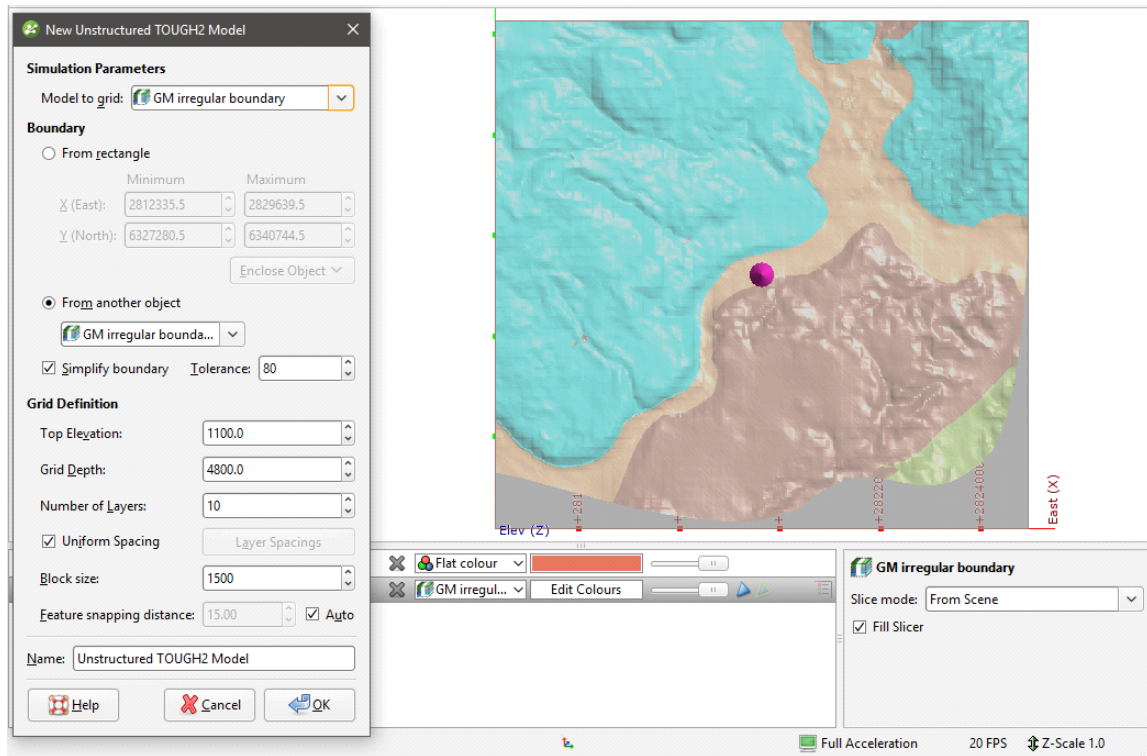

A geological model or a combined model can be used for the initial grid dimensions. Select the model required from the **Model to grid** list and set the dimensions of the grid.

Once you have created a new TOUGH2 model, you cannot change what model is used as the basis for the grid.

The **Boundary** can be rectangular or it can be defined from another object in the project.

The model should be slightly smaller than the selected model. Any TOUGH2 blocks that exist outside the model will be marked as inactive when the model is exported.

The **Simplify boundary** option reduces the number of points along the boundary. Reducing the **Tolerance** value increases the number of points along the boundary. The two settings together let you define a basic boundary with elements that are roughly uniform in size, set by the value of **Block size**. Once you have created the grid, you will be able to add features to it, which will change the size of the blocks.

Layers will be uniform, but if you want more control over the layers, untick the **Uniform Spacing** option and click **Layer Spacings** to set custom layers:

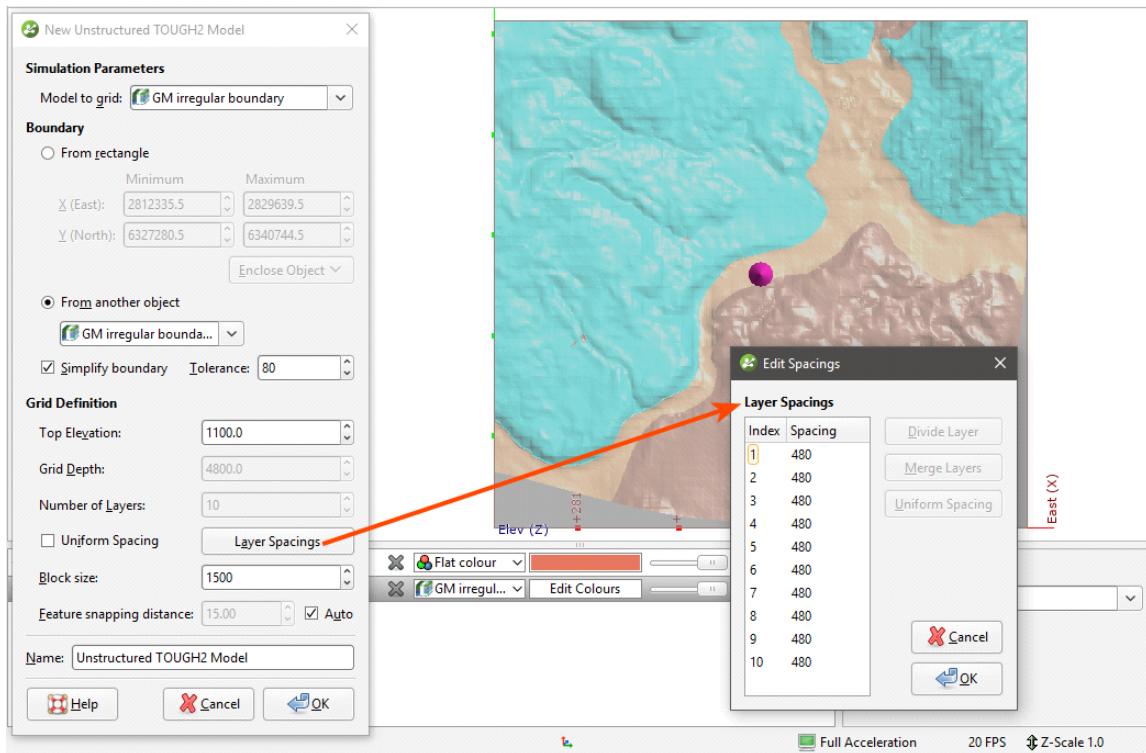

As with editing the spacings for a structured grid, there are four ways to change the spacings:

- Click on a value to edit it.
- Divide a row or column. Click on a row or column, then on the **Divide Row** or **Divide Column** button. Two new rows or columns will appear in the list.
- Merge rows or columns. Hold down the Shift key while clicking on each item, then click on the **Merge Rows** or **Merge Columns** button. The selected items will be combined.
- Set uniform spacing on selected rows or columns. You will be prompted to enter the number of cells you wish to create from the selected rows or columns.

The **Block size** setting determines the basic size of the blocks that make up the grid, although the size will vary according to features applied to the grid and the **Feature snapping distance**. The size will also vary if the **Simplify boundary** option is unticked, in which case the **Block size** setting is the maximum size of the blocks.

The **Feature snapping distance** is automatically set to 1 percent of the **Block size**. To use a smaller snapping distance, untick the **Auto** box and set the value required. You cannot set a value that is larger than 1 percent of the **Block size**.

The effects of the **Feature snapping distance** do not become apparent until features have been added to the grid.

Click **OK** to create the model, which will appear in the project tree under the **Flow Models** folder:

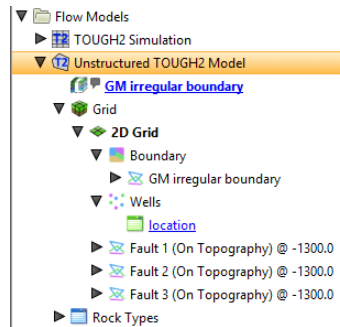

Features can be points (●), lines (—) or polygons (□).

Double-click on the 2D grid (◆) to see what features the grid has:

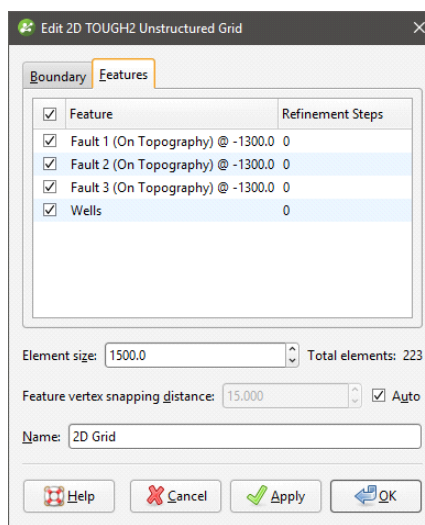

When the model is created, the well collars are added to the model as a feature. When a faulted geological model used to define the model, the geological model’s faults will be included on the grid as features.

Double-click on the wells object in the project tree to view the individual wells:

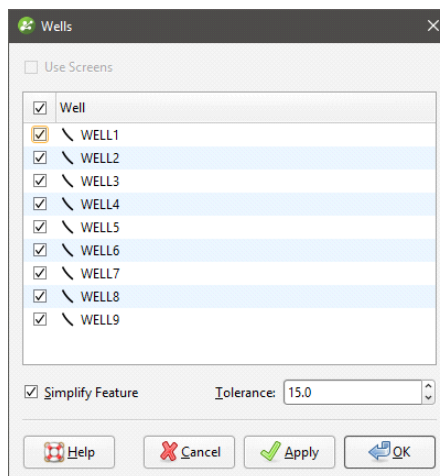

Untick any wells you do not want to use for defining the grid.

If screens are included in the well data, there will be a **Use Screens** option. When enabled, the x-y coordinates of the mid-point of the screen intervals will be used for the centre points. Otherwise, the x-y coordinates of the collar will be used.

Double-click on individual faults to change their settings.

To add features to the grid, right-click on the 2D grid (📍) in the project tree and select **New Feature**:

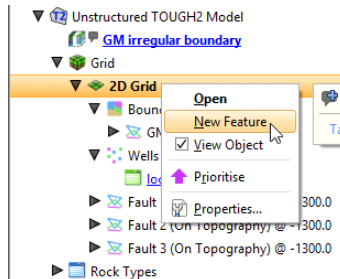

The **New TOUGH2 Feature** window will appear:

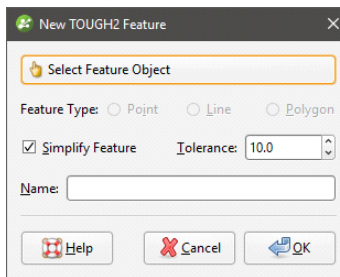

Click **Select Feature Object** to choose from suitable objects in the project. You can add **Point**, **Line** and **Polygon** features. Ticking the **Simplify Feature** option will reduce the number of points used.

Click **OK** to add the feature, which will appear in the project tree under the TOUGH2 grid object:

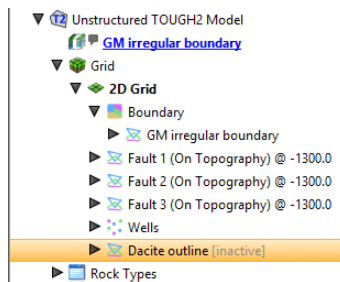

You can edit the feature by double-clicking on it or by right-clicking and selecting **Open**. However, the feature has not yet been applied to the grid. To enable the feature, double-click on the grid to open the **Edit 2D TOUGH2 Unstructured Grid** window. Tick the box to enable the feature, then adjust the number of **Refinement Steps**:

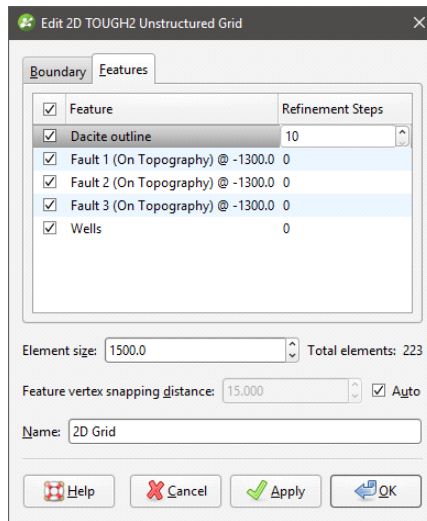

More **Refinement Steps** will produce more detail near the feature.

Click **Apply** or **OK** to view the effect the feature and its settings have on the grid.

If you want to modify a feature without having to reprocess the grid, untick it in the **Features** tab. If you want to delete a feature, right-click on it in the project tree and select **Delete**.

The images below show a grid displayed with collar points (in red) to demonstrate the effects of no features and collars applied with different refinement steps:

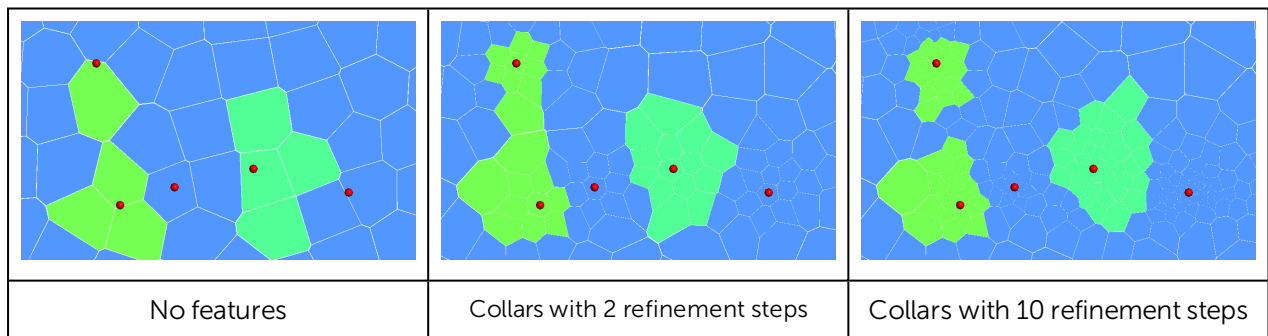

Importing TOUGH2 Models

You can import structured and unstructured TOUGH2 models into Leapfrog Geothermal. The process for each type is the same. Right-click on the **Flow Models** folder and select **TOUGH2 > Import Model**. Leapfrog Geothermal will ask you to specify the file location. Click **Open** to import the file.

The TOUGH2 model will appear in the project tree under the **Flow Models** folder. You can then load TOUGH2 inputs and outputs and generate rocktypes.

Loading TOUGH2 Outputs

To import the outputs, right-click on the model in the project tree and select **Import TOUGH2 Simulation Outputs**:

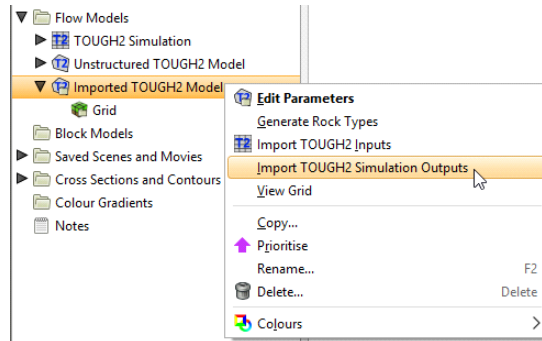

Navigate to the required file and click **Open**. The information will be added to the model and will appear in the project tree in a folder underneath the model:

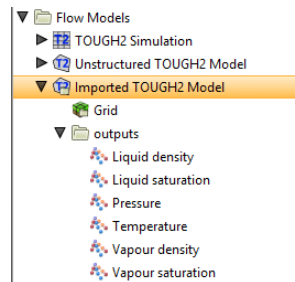

The outputs can be visualised as described in [Displaying TOUGH2 Models](#) below.

Loading TOUGH2 Inputs

If you have imported a TOUGH2 grid, you can load the model inputs. To do this, right-click on the model in the project tree and select **Import TOUGH2 Inputs**:

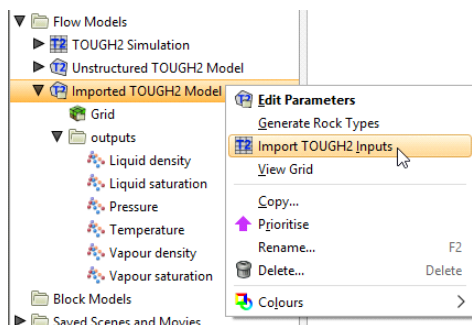

Select the inputs file and click **Open**. The information will be added to the TOUGH2 model and can be visualised as described in [Displaying TOUGH2 Models](#) below.

You can delete the inputs by right-clicking on the model in the project tree and selecting **Delete TOUGH2 Inputs**.

Generating Rocktypes

If you have not loaded inputs onto an imported TOUGH2 model, you can generate rocktypes by evaluating a geological model or combined in the project onto the TOUGH2 grid. To do this, right-click on the model in the project tree and select **Generate Rock Types**:

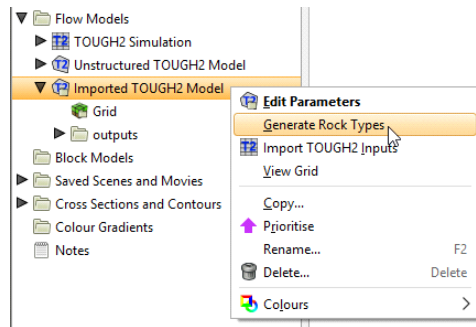

The list of models available in the project will be displayed. Select the required model, then click **OK**. The information will be added to the model and will appear in the project tree as part of the model:

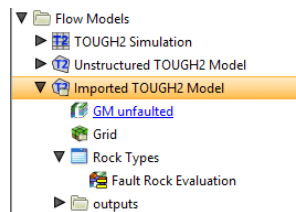

The rock types will be available as a colour option in the shape list when you display the model in the scene.

Displaying TOUGH2 Models

Display a TOUGH2 model by dragging it into the scene:

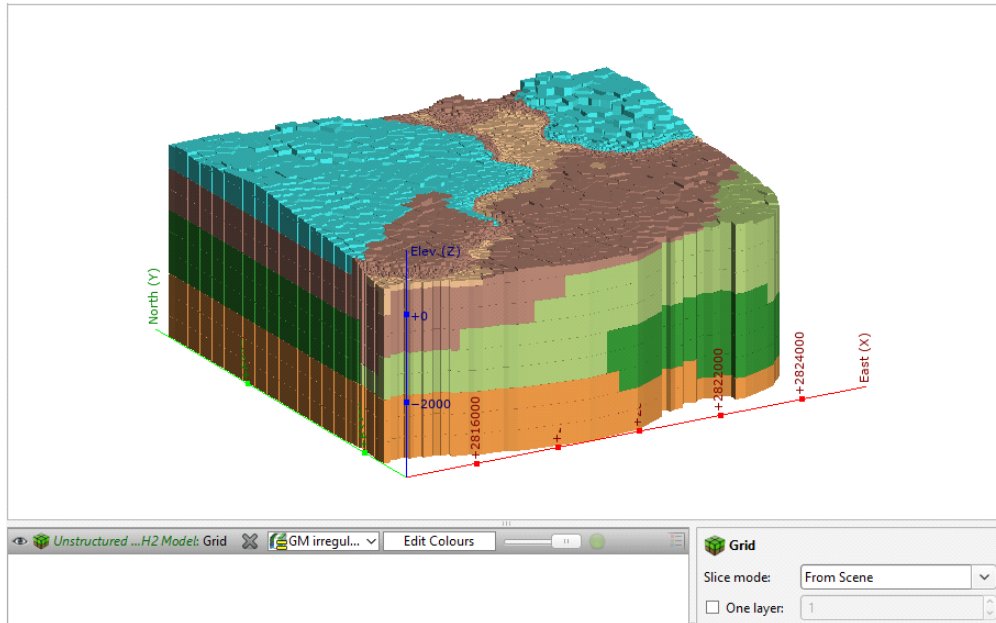

You can display the model as blocks or points, and you can display all layers or only one layer:

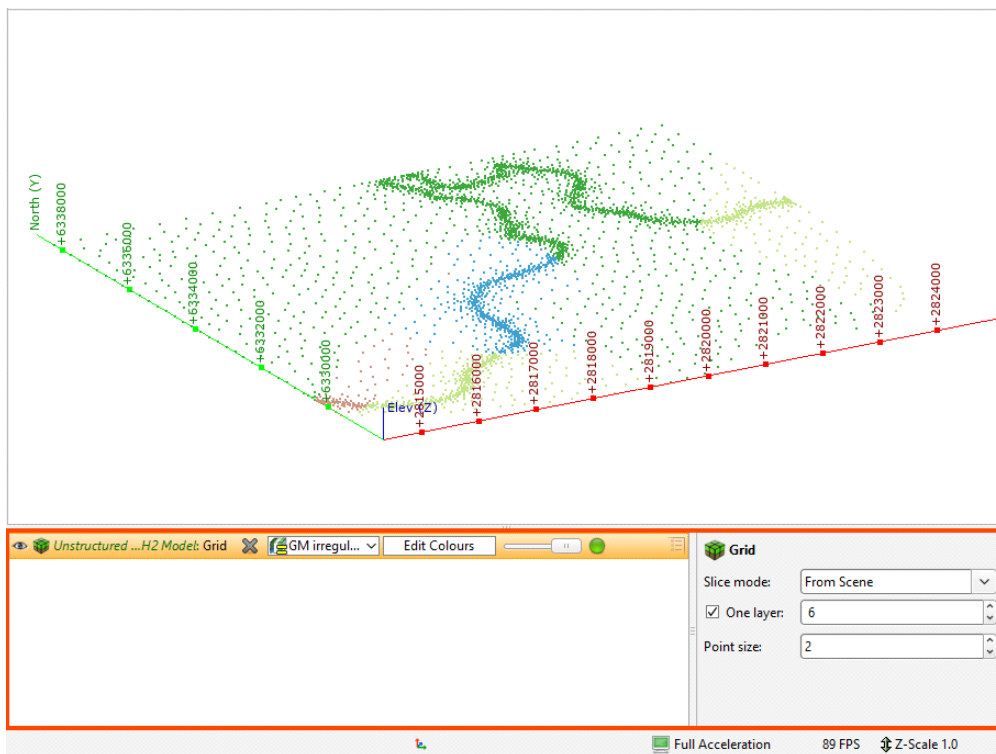

You can select any input as a colour option in the shape list. If the input is time-dependent, a timestep slider will be available from the shape properties panel:

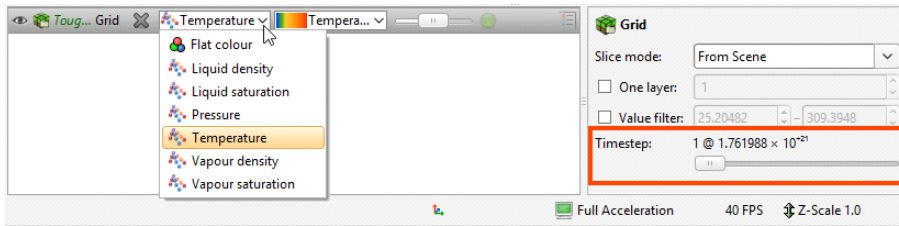

Click and drag the slider or click along the timeline to view the different timesteps available.

Editing TOUGH2 Grid Parameters

Once you have imported or created a TOUGH2 grid, you can edit information about the grid by double-clicking on the grid in the project tree or by right-clicking and selecting **Edit Parameters**. The **Edit TOUGH2 Simulation Model Parameters** window will appear:

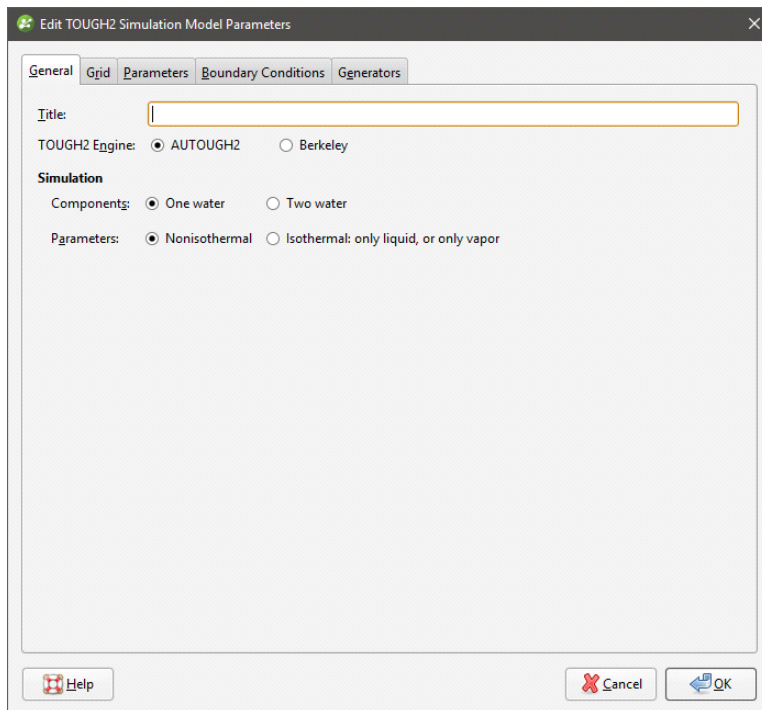

Select the **TOUGH2 Engine** used and set the simulation parameters. When the **Two water** component is selected, a **Mass Fraction** option is available when setting rocktypes for the simulation. See [Generating Rocktypes](#) for more information.

Note that if you select **Two water**, only the **Nonisothermal** option is available.

The **Grid** tab displays information about the grid definition.

In the other tabs, you can set TOUGH2 parameters and boundaries and define generators based on screens.

Generators can only be defined for structured models.

Once you have set all parameters required, click **OK** to save the changes.

TOUGH2 Parameters

The **Parameters** tab is divided into a number of sub-tabs along the left-hand side of the window:

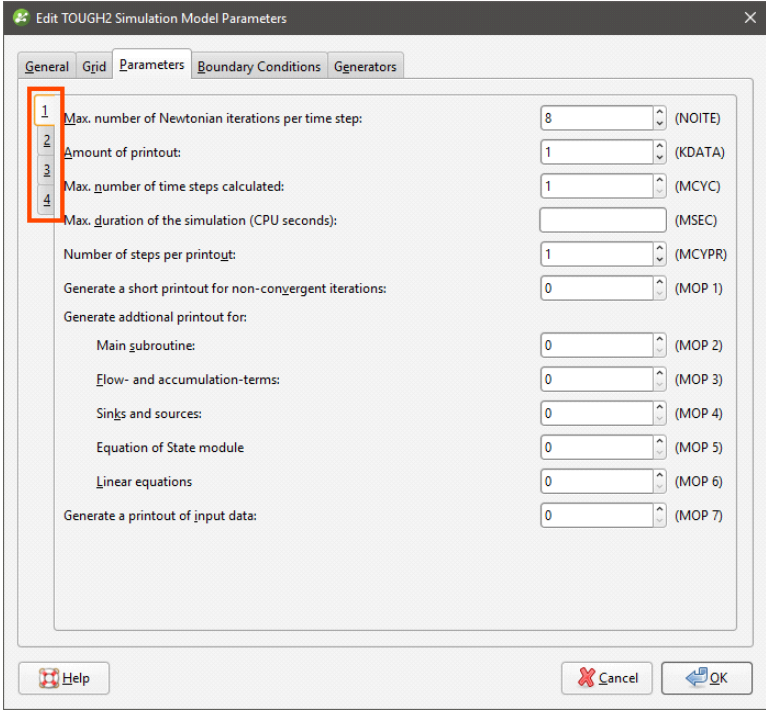

A negative value must be set for the **Length of time steps (DELTEN)** field before the **Duration of timestep (DLT)** fields can be set.

Once you have set the model parameters, click **OK** to make the changes.

TOUGH2 Boundary Conditions

Edit TOUGH2 boundary conditions by double-clicking on the model in the project tree, then selecting the **Boundary Conditions** tab:

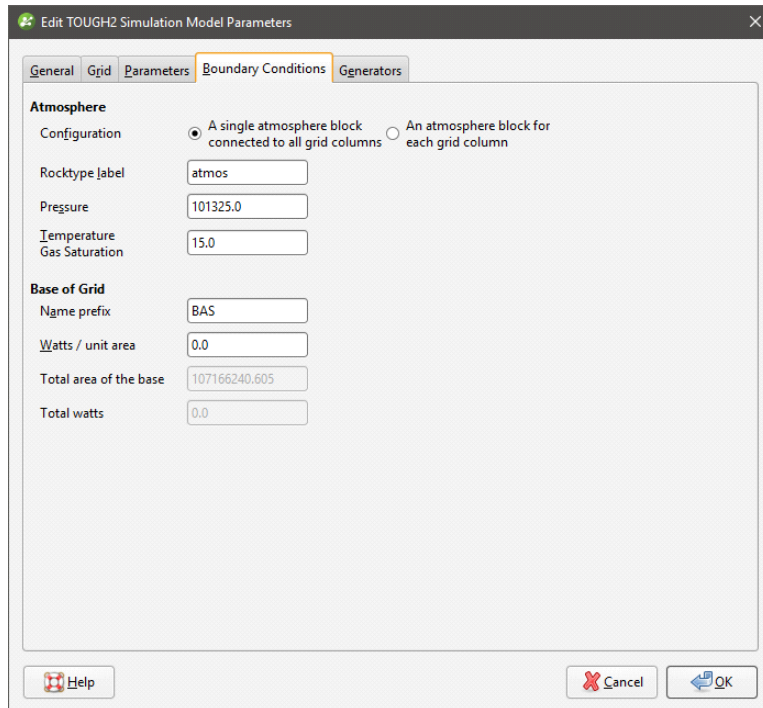

For **Atmosphere**, you can choose between:

- A single block that forms the top of all the grid columns
- Individual atmosphere blocks for each grid column

The **Pressure** and **Temperature Gas Saturation** units are kPa.

TOUGH2 Generators

If well data in the project includes a screens table, you can define generators for a structured TOUGH2 grid using the screens. To do this, double-click on the model in the project tree, then select the **Generators** tab:

In defining generators, it is important that the screens are correct and related to the wells; any errors in the screens table should be corrected before generators are defined.

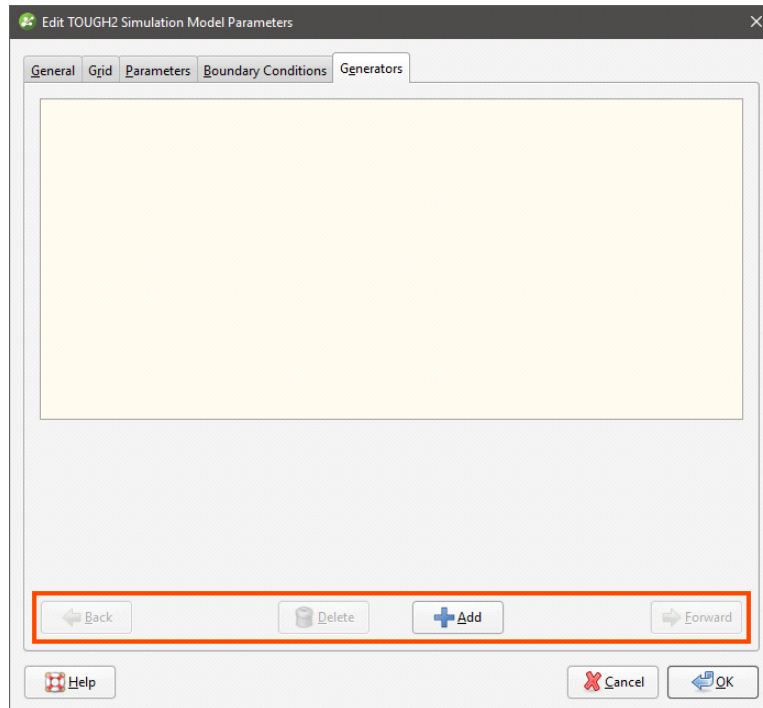

If the **Add** button at the bottom of the screen is greyed out, check that your screens table has been imported and that all errors in the table have been corrected.

Click the **Add** button to add a generator, then select the well required from the **Screen** list:

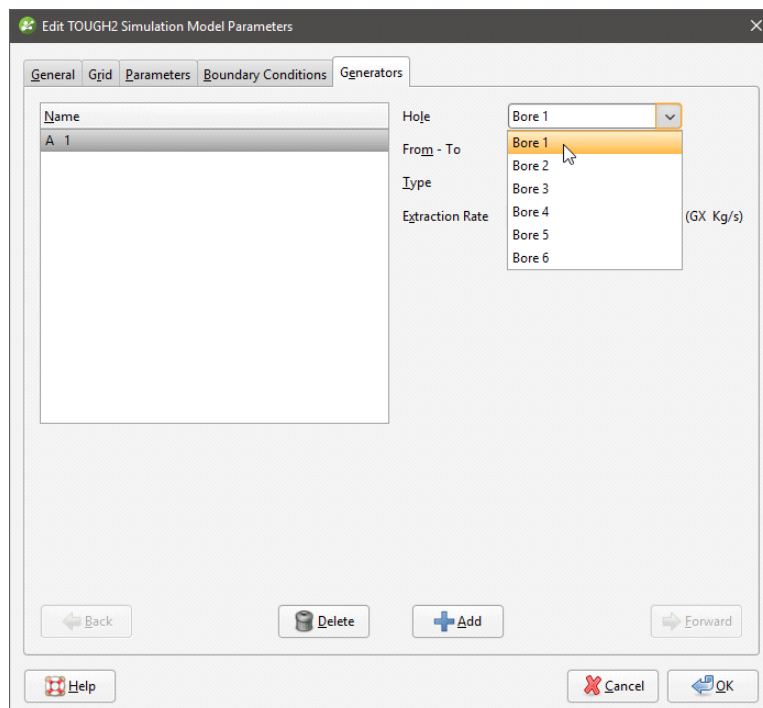

The **From - To** list displays the depths available for the selected well.

Select whether the **Type** is **Extraction**, **Injection** or **Heat**. Enter the properties required for each **Type**.

You can delete any generator by clicking on it in the table and selecting **Delete**.

Editing Rock Type Properties

To edit rock type properties for a TOUGH2 model, expand the model in the project tree and double-click on the rocktype object. The **Edit Rock Type Properties** window will appear:

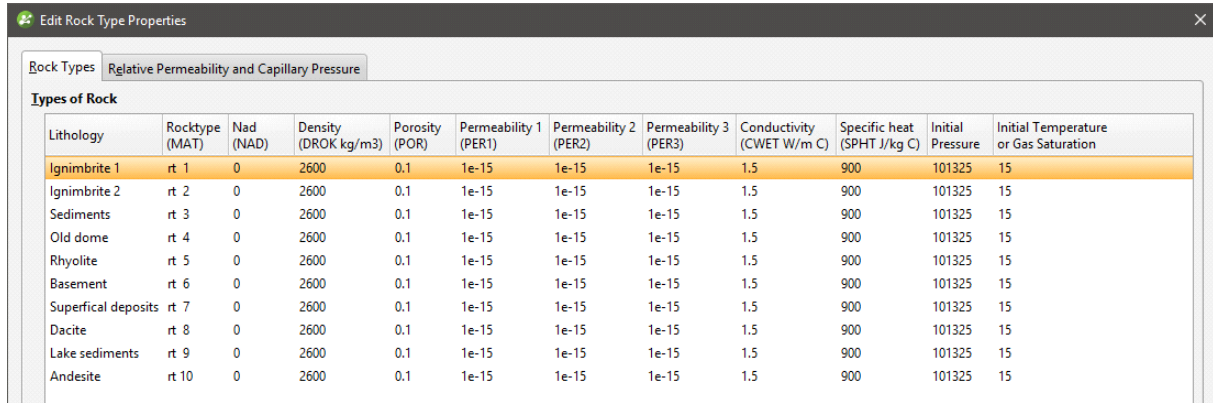

The screenshot shows the 'Edit Rock Type Properties' window with the 'Relative Permeability and Capillary Pressure' tab selected. The table below lists the properties for various rock types.

Lithology	Rocktype (MAT)	Nad (NAD)	Density (DROK kg/m3)	Porosity (POR)	Permeability 1 (PER1)	Permeability 2 (PER2)	Permeability 3 (PER3)	Conductivity (CWET W/m C)	Specific heat (SPHT J/kg C)	Initial Pressure	Initial Temperature or Gas Saturation
Ignimbrite 1	rt 1	0	2600	0.1	1e-15	1e-15	1e-15	1.5	900	101325	15
Ignimbrite 2	rt 2	0	2600	0.1	1e-15	1e-15	1e-15	1.5	900	101325	15
Sediments	rt 3	0	2600	0.1	1e-15	1e-15	1e-15	1.5	900	101325	15
Old dome	rt 4	0	2600	0.1	1e-15	1e-15	1e-15	1.5	900	101325	15
Rhyolite	rt 5	0	2600	0.1	1e-15	1e-15	1e-15	1.5	900	101325	15
Basement	rt 6	0	2600	0.1	1e-15	1e-15	1e-15	1.5	900	101325	15
Superficial deposits	rt 7	0	2600	0.1	1e-15	1e-15	1e-15	1.5	900	101325	15
Dacite	rt 8	0	2600	0.1	1e-15	1e-15	1e-15	1.5	900	101325	15
Lake sediments	rt 9	0	2600	0.1	1e-15	1e-15	1e-15	1.5	900	101325	15
Andesite	rt 10	0	2600	0.1	1e-15	1e-15	1e-15	1.5	900	101325	15

The window above shows properties for an unfaulted model. See [Evaluating a Faulted Model](#) for information on editing rock type properties for a faulted model.

Note that the **NAD** property is read-only and locked to zero.

The **Mass fraction of water 2** option can only be set for **Two water** simulations. See [TOUGH2 Parameters](#) for more information.

Evaluating a Faulted Model

A faulted rocktype evaluation is based on the fault system of the model associated with the TOUGH2 model. For TOUGH2 models created in Leapfrog Geothermal, the faulted rocktype evaluation is automatically created when the TOUGH2 model is defined; for imported TOUGH2 models, the evaluation is created when rocktypes are generated for the model.

Each fault is assigned its own lithology value and if more than one fault intersects a block, a combination lithology is created. This grid shows two intersecting faults (in pink) evaluated on the grid; all geological model blocks in this image are set to display in green. There are three faulted lithologies, one for each fault (blue and red) and one for the blocks where the two faults intersect (orange):

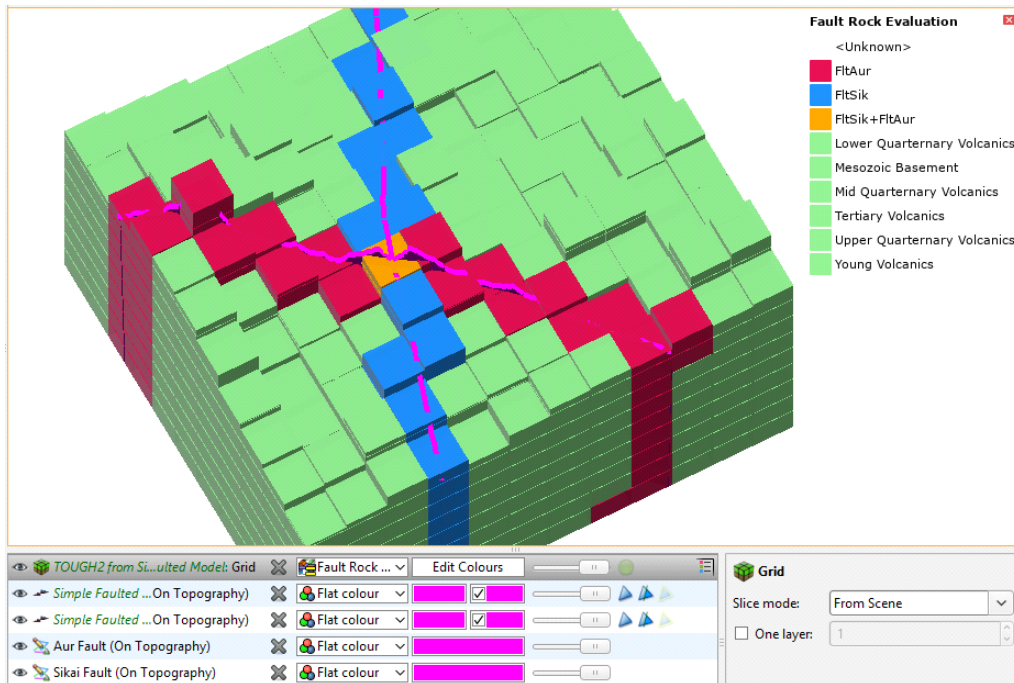

In the project tree, the **Fault Rock Evaluation** appears under the **Rock Types** table. You can change which of the model's faults are evaluated by double-clicking on the **Fault Rock Evaluation** and disabling faults:

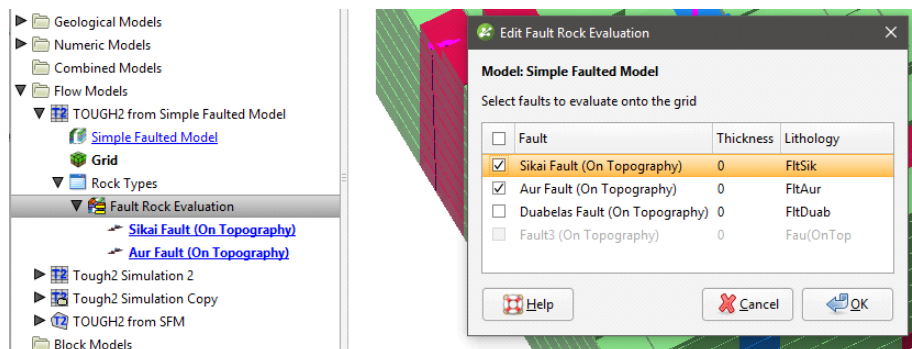

In this example, one fault (Duabelas) is disabled in the TOUGH2 model, whereas the greyed out fault (Fault3) is disabled in the geological model itself.

The **Thickness** value represents the width of the fault's crush zone. It is a distance value, and blocks within that distance are assigned the fault lithology. The default value is 0, which means that only blocks intersected by the fault will be assigned the fault lithology.

You can also change the evaluation names in the **Fault Rock Evaluation** window; simply double-click on the name and edit the text. It is recommended that you keep evaluation names shorter than 10 characters.

Fault lithologies are separated from the model’s lithological units in the rock type table:

Types of Rock											
Lithology	Rocktype (MAT)	Nad (NAD)	Density (DROK kg/m3)	Porosity (POR)	Permeability 1 (PER1)	Permeability 2 (PER2)	Permeability 3 (PER3)	Conductivity (CWET W/m C)	Specific heat (SPHT J/kg C)	Initial Pressure	Initial Temperature or Gas Saturation
Mid Quarternary Volcanics	rt 1	0	2600	0.1	1e-15	1e-15	1e-15	1.5	900	101325	15
Tertiary Volcanics	rt 2	0	2600	0.1	1e-15	1e-15	1e-15	1.5	900	101325	15
Upper Quarternary Volcanics	rt 3	0	2600	0.1	1e-15	1e-15	1e-15	1.5	900	101325	15
Mesozoic Basement	rt 4	0	2600	0.1	1e-15	1e-15	1e-15	1.5	900	101325	15

Types of Fault											
Lithology	Rocktype (MAT)	Nad (NAD)	Density (DROK kg/m3)	Porosity (POR)	Permeability 1 (PER1)	Permeability 2 (PER2)	Permeability 3 (PER3)	Conductivity (CWET W/m C)	Specific heat (SPHT J/kg C)	Initial Pressure	Initial Temperature or Gas Saturation
FitSik	rt 5	0	2600	0.1	1e-15	1e-15	1e-15	1.5	900	101325	15
FitAur	rt 6	0	2600	0.1	1e-15	1e-15	1e-15	1.5	900	101325	15
FitSik+FitAur	rt 7	0	2600	0.1	1e-15	1e-15	1e-15	1.5	900	101325	15

Copying a TOUGH2 Model

You can copy TOUGH2 models by right-clicking on them and selecting **Copy**. Enter a name for the copy of the model and click **OK**. The copy will be added to the project tree.

Creating a Static Copy of a TOUGH2 Model

You can create static copies of TOUGH2 models created in Leapfrog Geothermal. To do this, , right-click on the model in the project tree and select **Static Copy**. Enter a name for the copy of the model and click **OK**. The copy will be added to the **Flow Models** folder.

The grid geometry in a static TOUGH2 model cannot be changed. However, if the model associated with the TOUGH2 model is modified, the rock type table and the assignment of rock types to the grid blocks will be updated.

Exporting TOUGH2 Models

You can export the model inputs and the block lithologies.

Exporting Block Lithologies

To export block lithologies from a TOUGH2 model, you must first associate the model with a geological model or a combined model. See [Generating Rocktypes](#) for more information.

To export block lithologies, right-click on the table object (📄) underneath the TOUGH2 simulation and select **Export Block Lithologies**. Leapfrog Geothermal will ask you to specify the file location. You will then be prompted for an output filename. Enter a name and click **OK**.

Exporting TOUGH2 Inputs

To export TOUGH2 inputs from a TOUGH2 model, you must first associate the model with a geological model or a combined model. See [Generating Rocktypes](#) for more information.

When you export a TOUGH2 grid, two files are saved:

- The *.DAT file is the TOUGH2 inputs.
- The *_geometry.DAT file is the grid definition.

To export inputs, right-click on simulation in the project tree and select **Export TOUGH2 Input**. Leapfrog Geothermal will ask you to specify the file location. You will then be prompted for an output filename. Enter a name and click **OK**.

TETRAD Models

In Leapfrog Geothermal, you can import and visualise TETRAD models and load time-dependent outputs. This topic describes:

- [Importing a TETRAD Model](#)
- [Loading Simulation Outputs](#)
- [Displaying the Model](#)
- [Exporting the Model](#)

Importing a TETRAD Model

To import a TETRAD model, right-click on the **Flow Models** folder and select **TETRAD > Import Model**. Leapfrog Geothermal will ask you to specify the file location. Click **Open** to import the file.

Next, the **Edit TETRAD Model** window will be displayed. If the model is in the wrong location, you can adjust its location using the controls in this window and in the scene:

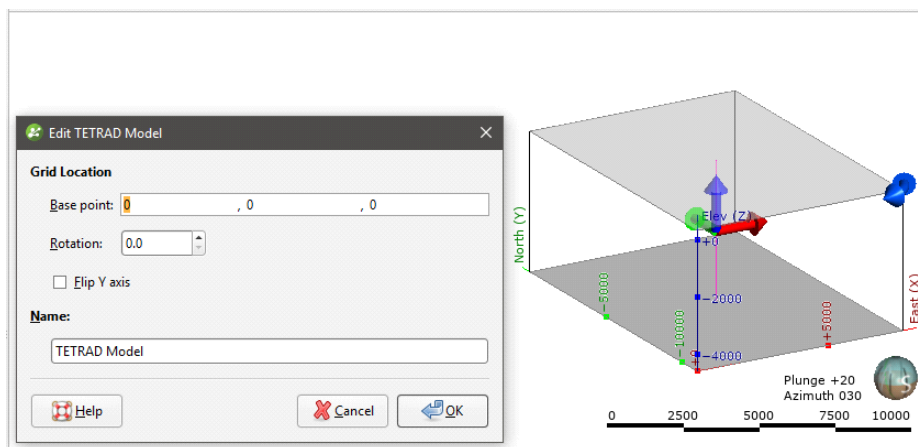

The red handle changes the X value, the green changes the Y value and the blue changes the Z value. Use the corner handle to rotate the grid.

If the X and Y axes are in the wrong location in relation to the Z axis, you can flip the model by enabling the **Flip Y axis** option.

Click **OK** to save the imported grid. The model will appear in the project tree in the **Flow Models** folder:

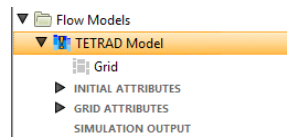

You can edit the settings for any imported TETRAD grid by double-clicking on it in the project tree.

Loading Simulation Outputs

To load simulation outputs, right-click on the model in the project tree and select **Import TETRAD Simulation Output**. In the window that opens, navigate to where the outputs file is stored, select the file and click **Open**. The outputs will be loaded and saved in the project tree:

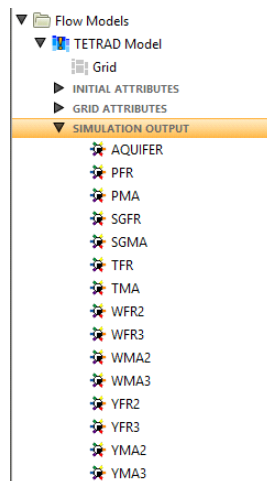

Displaying the Model

Dragging the model () into the scene displays its grid object. You can display the grid by any of its outputs. When the results are time-dependent, a timestep slider will be available from the shape properties panel:

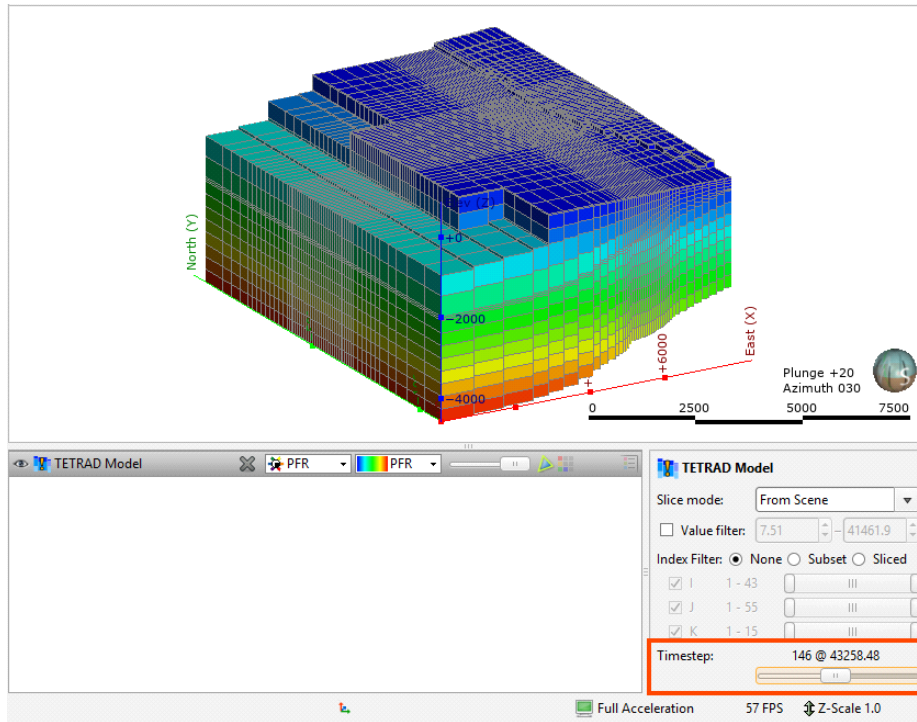

Click and drag the slider or click along the timeline to view the different timesteps available.

Exporting the Model

You can export the grid in *.csv format, with or without the time-dependent data. When you choose not to export the time-dependent data, only the initial attributes will be exported. To export the model, right-click on it in the project tree and select **Export to CSV**. Leapfrog Geothermal will ask whether you wish to include time-dependent data. Select an option and then specify the file location and output filename. Click **Save**.

Note that exporting the model with the time-dependent simulation outputs can take some time.

Block Models

The **Block Models** folder can be used to import and create block models. Model types that can be imported are:

- Isatis files
- CSV files

You can also create block models and sub-blocked models, which can then be exported for use in other applications. Creating block models within Leapfrog Geothermal has the advantage that the resolution can easily be changed.

Block models can be evaluated against geological models and interpolants as described in [Evaluations](#).

The rest of this topic describes importing block models in Isatis and CSV formats, creating block models in Leapfrog Geothermal, viewing block model statistics and exporting block models. It is divided into:

- [Importing a Block Model](#)
- [Creating a Block Model](#)
- [Displaying a Block Model](#)
- [Viewing Block Model Statistics](#)
- [Exporting Block Models](#)

Importing a Block Model

Leapfrog Geothermal imports block models in the following formats:

- CSV + Text Header (*.csv, *.csv.txt)
- CSV with Embedded Header (*.csv)
- Isatis Block Model Files (*.asc)

Note that neither CSV format requires a header; once you start the import process, Leapfrog Geothermal will use the data in the file to locate the minimum and maximum centroids. You can view this information and change how the data is mapped before the file is saved into the project.

Importing an Isatis Block Model

To import an Isatis format block model, right-click on the **Block Models** folder and select **Import Block Model**. Select the file you wish to import and click **Open**. The model will be imported and added to the **Block Models** folder.

Importing a Block Model in CSV Format

Block models imported in CSV format must be regular, rotated only about the Z axis. You will also need to map the data in the file to the block model format Leapfrog Geothermal expects.

To import a block model in CSV format, right-click on the **Block Models** folder and select **Import Block Model**. Select the file you wish to import and click **Open**. An import window will be displayed in which you can map the columns in the file to those Leapfrog Geothermal expects. Once you have mapped the required columns, click **Next** to define the grid.

In the next window, Leapfrog Geothermal uses the data in the file to check the grid definition and confirm that the centroids match:

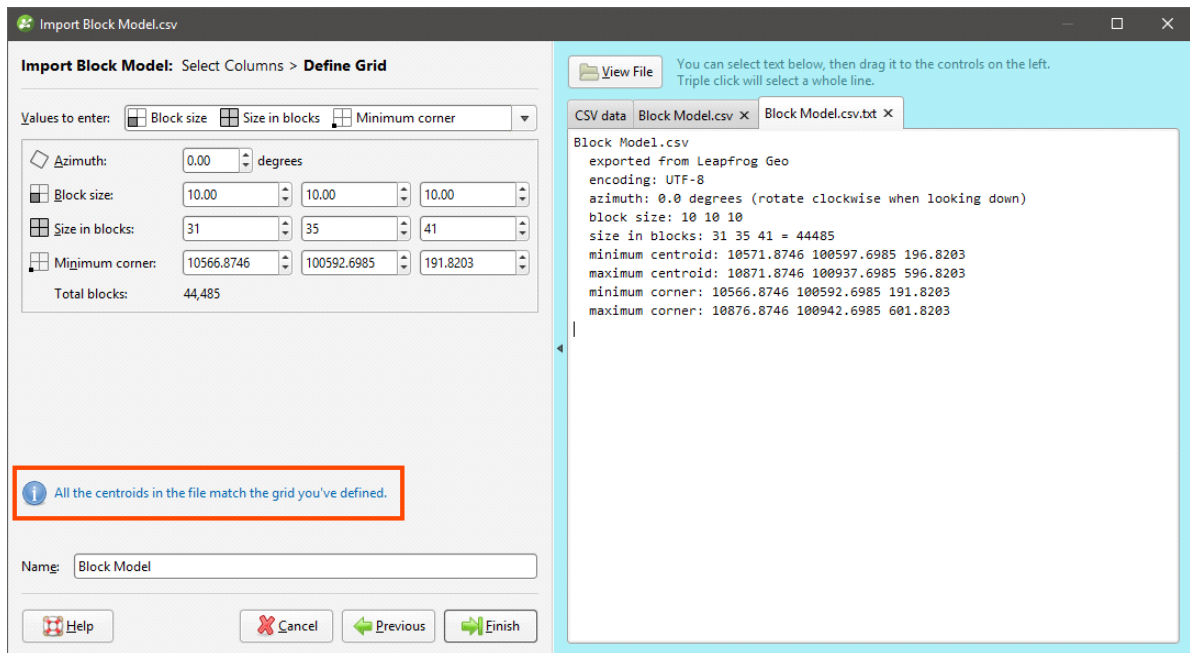

If this information is incorrect, you can select information in the file and drag it to the corresponding values on the left-hand side:

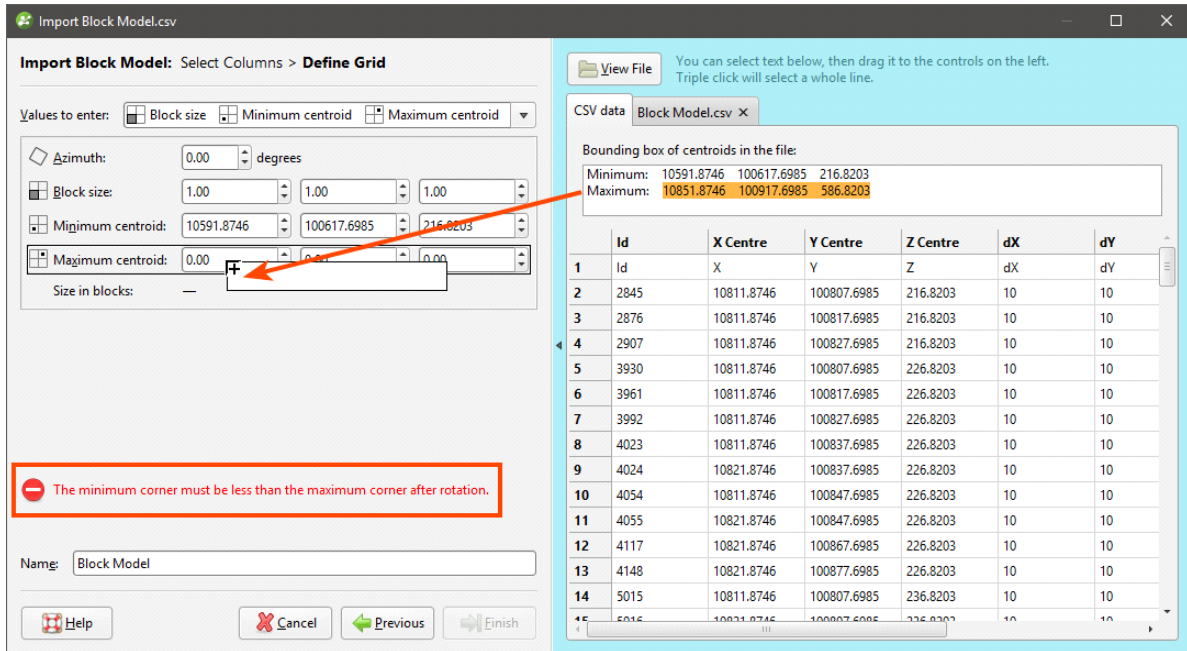

The easiest way to define the blocks is to use the **Block size, Minimum centroid, Maximum centroid** option. You can also enter the grid definition values manually.

Once Leapfrog Geothermal has validated the grid definition, click **Finish**. The block model will be imported and will appear in the **Block Models** folder.

Creating a Block Model

To create a new block model, right-click on the **Block Models** folder and select **New Block Model**. The **New Block Model** window will appear, together with a set of controls that will help you set the size, location and orientation of the model in the scene:

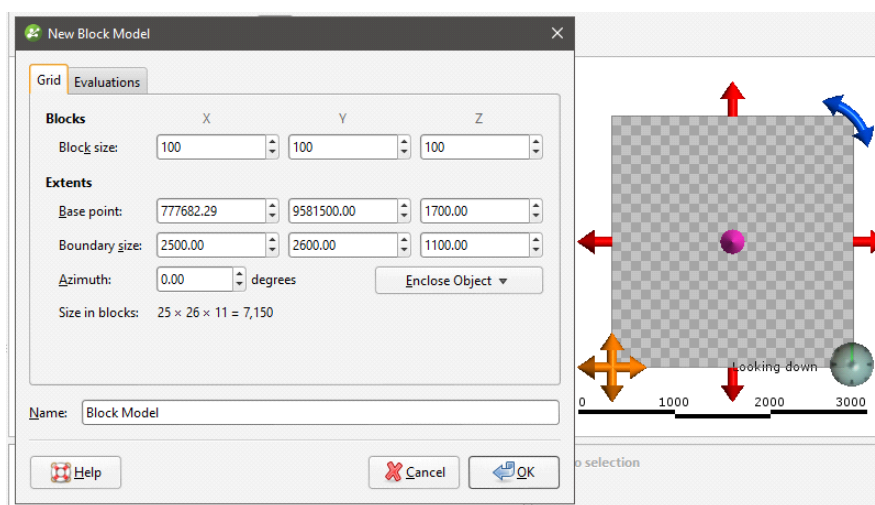

The block model is defined from its **Base point**, and the reference centroid is the **Base point** plus one half the **Block size**. Block models cannot have partial blocks, and when changes are

made to the **Block size** parameter, the model's extents will be enlarged to match the **Block size**.

If you know the values you wish to use for the model's **Extents**, enter them in **New Block Model** window. You can also:

- Use the controls in the scene to set the extents.
 - The orange handle sets the **Base point**.
 - The red handles adjusts the size of the boundary.
 - The blue handle adjusts the **Azimuth**.
- Use another object's extents. Select the object from the **Enclose Object** list.

If you wish to define a tilted block model, create a sub-blocked model with no triggers. See [Sub-Blocked Models](#).

It is a good idea to use larger values for the **Block size** as processing time for large models can be considerable. Once you have created a block model, you can change its properties to provide more detail.

You can also evaluate the block model against geological models, interpolants and distance functions in the project. To do this, click on the **Evaluations** tab. All objects available in the project will be displayed. Move the models you wish to use into the **Selected** list.

Enter a **Name** for the block model and click **OK**. The model will appear under the **Block Models** folder. You can make changes to it by double-clicking on it.

Displaying a Block Model

When a block model is displayed in the scene, there is an **Index Filter** option for displaying the grid:

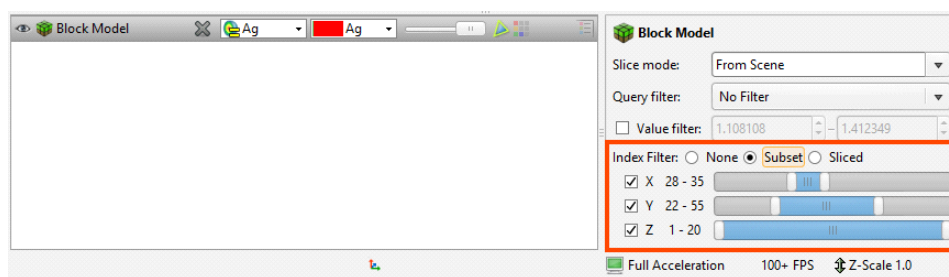

For **None**, no X, Y or Z filter is applied. For **Subset**, the grid is filtered to show the union of the selected X, Y and Z ranges. For **Sliced**, the grid is filtered to show the intersection of the selected X, Y and Z ranges.

For the **Subset** and **Sliced** options, tick the boxes for X, Y and Z. To adjust the range, drag the white handles left and right. Double-clicking on the slider alternates between displaying a single value and displaying the full range.

Viewing Block Model Statistics

To view statistics on a block model, right-click on the model in the project tree and select **Statistics**. The following options are available:

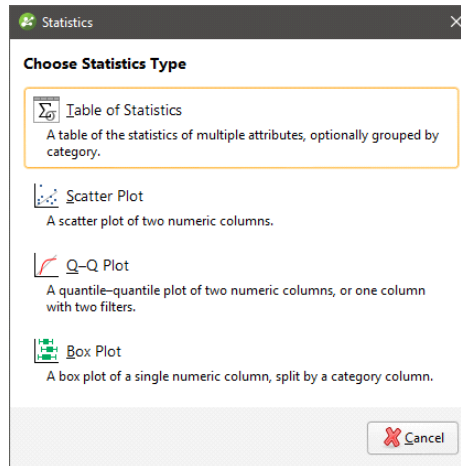

See the [Analysing Data](#) topic for more information on each option:

- [Table of Statistics](#)
- [Scatter Plots](#)
- [Q-Q Plots](#)
- [Box Plots](#)

Right-clicking a block model evaluation or a numeric calculation and selecting **Statistics** opens a univariate graph for the selection. See [Univariate Graphs](#) in the [Analysing Data](#) topic for more information.

Exporting Block Models

Block models created in Leapfrog Geothermal can be exported in the following formats:

- CSV + Text Header (*.csv, *.csv.txt)
- CSV with Embedded Header (*.csv)
- CSV as points (*.csv)
- Isatis Block Model Files (*.asc)
- Surpac Block Model Files (*.mdl)
- Datamine Block Model Files (*.dm)

To export a block model, right-click on the block model in the project tree and select **Export**. You will be prompted to select the file format.

If you wish to export the model in one of the CSV formats, select **CSV Block Model Files (*.csv)** in the **Export Block Model** window. You will be able to choose between the three CSV formats in the next step.

Enter a name and location for the file and click **Save**. Next, you will be able to choose custom settings for the selected format.

The rest of this topic provides more information about exporting block models in CSV, Isatis, Datamine and Surpac formats.

- [Exporting Block Models in CSV Format](#)
- [Exporting Block Models in Isatis Format](#)
- [Exporting Block Models in Datamine Format](#)
- [Exporting Block Models in Surpac Format](#)

Exporting Block Models in CSV Format

The selections you make when you export a block model will be saved. This streamlines the process of subsequent exports of the model.

When you choose to export a block model in CSV format, you must first choose the type of CSV export. Options are:

- With an embedded header file. The block model definition is included at the top of the CSV file.
- With a separate text header. The block model definition is written as a separate text file.
- As points. The CSV file does not include the block sizes and model description.

Click **Next**. The steps that follow are:

- [Selecting From Evaluated Items](#)
- [Setting Row Filtering Options](#)
- [Setting Numeric Precision](#)
- [Setting Status Code Text Sequences](#)
- [Selecting the Character Set](#)

Selecting From Evaluated Items

Choose which objects will be included in the exported file. The **Available items** list includes all evaluations made onto the model. The order of columns in the exported file will match the order shown in the project tree.

Click **Next**.

Setting Row Filtering Options

The settings in the **Filtering** window are useful when all block results in are consistently the same non-Normal status. Select from **Error**, **Without grade**, **Blank** or **Outside**; all rows that consistently show the selected statuses will not be included in the exported file.

Click **Next**.

Setting Numeric Precision

There are three encoding options for **Numeric Precision**:

- The **Double, floating point** option provides precision of 15 to 17 significant decimal places.
- The **Single, floating point** option provides precision of 6 to 9 significant decimal places.
- The **Custom** option lets you set a specific number of decimal places.

To change either the **Centroid and size precision** and **Column data precision** options, untick the box for **Use default precision** and select the required option.

Click **Next**.

Setting Status Code Text Sequences

When a block model is exported, non-Normal status codes can be represented in the exported file using custom text sequences.

The **Status Code** sequences are used for category status codes and filter status codes exported as columns.

Numeric Status Codes can be represented using custom text sequences. This is optional; if no separate codes are defined for numeric items, the defined **Status Codes** will be used.

Click **Next**.

Selecting the Character Set

The selection you make will depend on the target for your exported file. You can choose a character set and see what changes will be made.

Click **Next** to view a summary of the selected options, then click **Export** to save the file.

Exporting Block Models in Isatis Format

The selections you make when you export a block model will be saved. This streamlines the process of subsequent exports of the model.

When exporting a block model in Isatis format, the steps to follow are:

- [Selecting From Evaluated Items](#)
- [Setting Status Code Text Sequences](#)
- [Selecting the Character Set](#)

Selecting From Evaluated Items

Choose which objects will be included in the exported file. The **Available items** list includes all evaluations made onto the model. The order of columns in the exported file will match the order shown in the project tree.

Click **Next**.

Setting Status Code Text Sequences

When a block model is exported, non-Normal status codes can be represented in the exported file using custom text sequences.

When exporting block models in Isatis format, both category and numeric status codes can use independent custom text sequences.

Click **Next**.

Selecting the Character Set

The selection you make will depend on the target for your exported file. You can choose a character set and see what changes will be made.

Click **Next** to view a summary of the selected options, then click **Export** to save the file.

Exporting Block Models in Datamine Format

The selections you make when you export a block model will be saved. This streamlines the process of subsequent exports of the model.

When exporting a block model in Datamine format, the steps to follow are:

- [Selecting From Evaluated Items](#)
- [Setting Row Filtering Options](#)
- [Setting Status Code Text Sequences](#)
- [Selecting the Character Set](#)
- [Renaming Items](#)

Selecting From Evaluated Items

Choose which objects will be included in the exported file. The **Available items** list includes all evaluations made onto the model. The order of columns in the exported file will match the order shown in the project tree.

Click **Next**.

Setting Row Filtering Options

The settings in the **Filtering** window are useful when all block results in are consistently the same non-Normal status. Select from **Error**, **Without grade**, **Blank** or **Outside**; all rows that consistently show the selected statuses will not be included in the exported file.

Click **Next**.

Setting Status Code Text Sequences

When a block model is exported, non-Normal status codes can be represented in the exported file using custom text sequences.

When exporting block models in Datamine format, both category and numeric status codes can use independent custom text sequences.

Click **Next**.

Selecting the Character Set

The selection you make will depend on the target for your exported file. You can choose a character set and see what changes will be made.

Click **Next**.

Renaming Items

When exporting a block model in Datamine format, column names for the evaluated objects have a maximum length of 8 characters. Leapfrog Geothermal will recommend truncated column names, but if you wish to use different abbreviations, click on the item's **New Name** to edit it.

Click **Next** to view a summary of the selected options, then click **Export** to save the file.

Exporting Block Models in Surpac Format

The selections you make when you export a block model will be saved. This streamlines the process of subsequent exports of the model.

When you choose to export a block model in Surpac format, you must first choose whether to export the model in Surpac version 3.2 or Surpac version 5.0. Considerations are as follows:

- Block models exported in Surpac version 5.0 cannot be imported into versions of Surpac before 5.0.
- Block models with more than 512 blocks per side can only be exported in Surpac version 5.0 format.

Choose which format you wish to use.

Click **Next**. The steps that follow are:

- [Selecting From Evaluated Items](#)
- [Setting Row Filtering Options](#)
- [Setting Numeric Precision](#)
- [Setting Status Code Text Sequences](#)
- [Selecting the Character Set](#)

Selecting From Evaluated Items

Choose which objects will be included in the exported file. The **Available items** list includes all evaluations made onto the model. The order of columns in the exported file will match the order shown in the project tree.

Click **Next**.

Setting Row Filtering Options

The settings in the **Filtering** window are useful when all block results in are consistently the same non-Normal status. Select from **Error**, **Without grade**, **Blank** or **Outside**; all rows that consistently show the selected statuses will not be included in the exported file.

Click **Next**.

Setting Numeric Precision

There are two encoding options for **Numeric Precision**:

- The **Double, floating point** option provides precision of 15 to 17 significant decimal places.
- The **Single, floating point** option provides precision of 6 to 9 significant decimal places.

To use one of these options, untick the box for **Use default precision** and select the required option.

If you are exporting the model in Surpac version 5.0, you can change the **Display precision** used for the **Double, floating point** and **Single, floating point** options.

Click **Next**.

Setting Status Code Text Sequences

When exporting block models in Surpac format, non-Normal category and numeric status codes can be represented in the exported file using custom text sequences. Status codes cannot be used for Boolean values; non-Normal values are set to false.

Click **Next**.

Selecting the Character Set

The selection you make will depend on the target for your exported file. You can choose a character set and see what changes will be made.

Click **Next** to view a summary of the selected options, then click **Export** to save the file.

Sub-Blocked Models

A sub-blocked model is a block model that is subdivided into smaller blocks where triggering surfaces intersect the blocks. Sub-blocked models can be rotated in two axes by adjusting the dip and azimuth. This topic describes creating and exporting sub-blocked models. It is divided into:

- [Creating a Sub-Blocked Model](#)
- [Sub-Blocked Model Export](#)

Creating a Sub-Blocked Model

To create a new sub-blocked model, right-click on the **Block Models** folder and select **New Sub-blocked Model**. The **New Sub-blocked Model** window will appear, together with a set of controls that will help you set the size, location and orientation of the model in the scene:

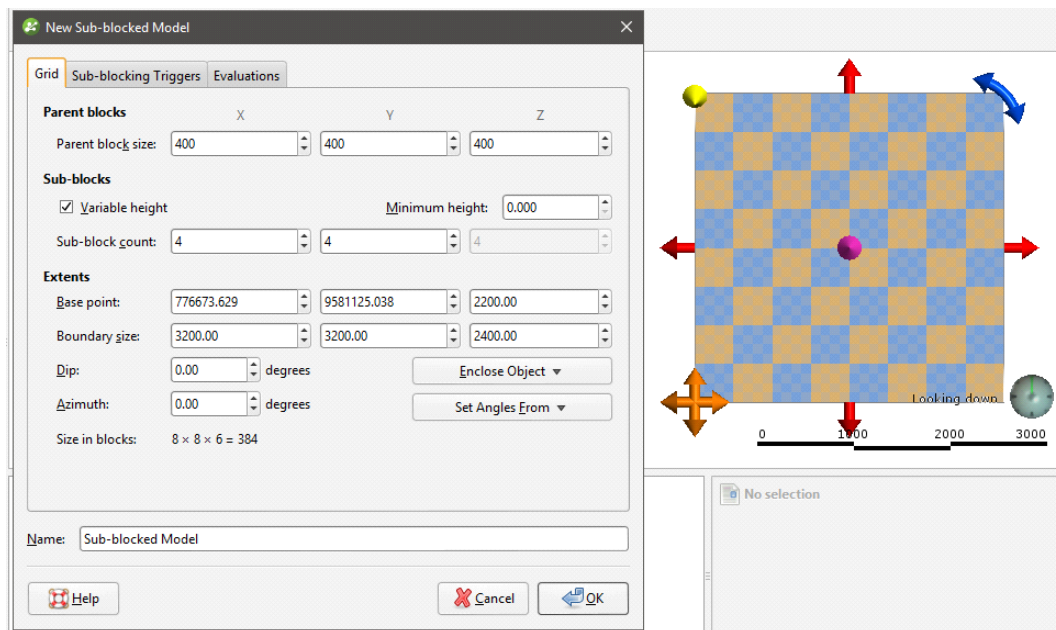

The block model is defined from its **Base point**, and the reference centroid is the **Base point** plus one half the **Block size**. Block models cannot have partial blocks, and when changes are made to the **Block size** parameter, the model's extents will be enlarged to match the **Block size**.

Model Extents and Rotation

It is a good idea to set the sub-blocked model's extents from another object in the project, selecting the required object from the **Enclose Object** list.

The **Dip** and **Azimuth** set the rotation of the model. If you know the values you wish to use, enter them in **New Sub-blocked Model** window. You can also:

- Use the controls in the scene to set the orientation. The yellow handle adjusts the **Dip** and the blue handle adjusts the **Azimuth**.
- Use either the slicer or the moving plane to set the orientation. To do this, add the slicer or the moving plane to the scene and adjust the orientation. Then select the object to use from the **Set Angles From** list.

If you have set the extents from another object and then rotated the model, you will need to reset the extents by selecting the object again from the **Enclose Object** list.

The Grid Pattern

The cross-hatched pattern shows how the parent blocks will be divided up into sub-blocks. These properties can be changed by adjusting the **Parent blocks** and **Sub-blocks** settings. The **Sub-block count** is the number of blocks each parent block is divided into when it intersects a trigger. The number of blocks in the Z axis can be:

- A variable value, based on when the parent blocks intersect triggers. Tick the **Variable height** box and set a **Minimum height**, if required.
- A fixed value. Untick the **Variable height** box and set the Z value required.

Triggers and Evaluations

Click on the **Sub-blocking Triggers** tab to select triggers from the volumes available in the project. Triggers can be:

- Geological model volumes
- Interpolant volumes
- Open meshes

All suitable objects in the project will be displayed in the **Available triggers** list.

Sub-blocked models can be evaluated against geological models, interpolants and distance functions in the project. To do this, click on the **Evaluations** tab. All objects available in the project will be displayed. Move the models you wish to use into the **Selected** list, then select the **Evaluation Type**, which can be on the sub-block centroids or on the parent block centroids.

Enter a **Name** for the sub-blocked model and click **OK**. The model will appear under the **Block Models** folder. You can make changes to it by double-clicking on it.

Sub-Blocked Model Statistics

You can view statistics for all evaluations made on a sub-blocked model broken down into categories and organised by numeric evaluations. To view summary statistics, right-click on a sub-blocked model in the project tree and select **Statistics**.

See [Viewing Block Model Statistics](#) in the [Block Models](#) topic for more information.

Sub-Blocked Model Export

Sub-blocked models created in Leapfrog Geothermal can be exported in the following formats:

- CSV + Text header (*.csv, *.csv.txt)
- CSV with embedded header (*.csv)
- CSV as points (*.csv)
- Datamine Block Model (*.dm)

To export a sub-blocked model, right-click on the model in the project tree and select **Export**. You will be prompted to select the file format.

If you wish to export the model in one of the CSV formats, select **CSV Block Model Files (*.csv)** in the **Export Block Model** window. You will be able to choose between the three CSV formats in the next step.

Enter a name and location for the file and click **Save**. Next, you will be able to choose custom settings for each format.

The **Export as Points** menu option available in previous versions of Leapfrog Geothermal has been removed. This functionality has been integrated into the **Export** menu option.

The rest of this topic provides more information about exporting sub-blocked models in CSV and Datamine formats.

- [Exporting Sub-Blocked Models in CSV Format](#)
- [Exporting Sub-Blocked Models in Datamine Format](#)

Exporting Sub-Blocked Models in CSV Format

The selections you make when you export a block model will be saved. This streamlines the process of subsequent exports of the model.

When you choose to export a sub-blocked model in CSV format, you must first choose the type of CSV export. Options are:

- With an embedded header file. The sub-blocked model definition is included at the top of the CSV file.
- With a separate text header. The sub-blocked model definition is written as a separate text file.
- As points. The CSV file does not include the block sizes and the sub-blocked model description.

Click **Next**. The steps that follow are:

- [Selecting From Evaluated Items](#)
- [Setting Row Filtering Options](#)
- [Setting Numeric Precision](#)
- [Setting Status Code Text Sequences](#)
- [Selecting the Character Set](#)

Selecting From Evaluated Items

Choose which objects will be included in the exported file. The **Available items** list includes all evaluations made onto the model. The order of columns in the exported file will match the order shown in the project tree.

Click **Next**.

Setting Row Filtering Options

The settings in the **Filtering** window are useful when all block results in are consistently the same non-Normal status. Select from **Error**, **Without grade**, **Blank** or **Outside**; all rows that consistently show the selected statuses will not be included in the exported file.

Click **Next**.

Setting Numeric Precision

There are three encoding options for **Numeric Precision**:

- The **Double, floating point** option provides precision of 15 to 17 significant decimal places.
- The **Single, floating point** option provides precision of 6 to 9 significant decimal places.
- The **Custom** option lets you set a specific number of decimal places.

To change either the **Centroid and size precision** and **Column data precision** options, untick the box for **Use default precision** and select the required option.

Click **Next**.

Setting Status Code Text Sequences

When a block model is exported, non-Normal status codes can be represented in the exported file using custom text sequences.

The **Status Code** sequences are used for category status codes and filter status codes exported as columns.

Numeric Status Codes can be represented using custom text sequences. This is optional; if no separate codes are defined for numeric items, the defined **Status Codes** will be used.

Click **Next**.

Selecting the Character Set

The selection you make will depend on the target for your exported file. You can choose a character set and see what changes will be made.

Click **Next** to view a summary of the selected options, then click **Export** to save the file.

Exporting Sub-Blocked Models in Datamine Format

The selections you make when you export a sub-blocked model will be saved. This streamlines the process of subsequent exports of the model.

When exporting a sub-blocked model in Datamine format, the steps to follow are:

- [Selecting From Evaluated Items](#)
- [Setting Row Filtering Options](#)
- [Setting Status Code Text Sequences](#)
- [Selecting the Character Set](#)
- [Renaming Items](#)

Selecting From Evaluated Items

Choose which objects will be included in the exported file. The **Available items** list includes all evaluations made onto the model. The order of columns in the exported file will match the order shown in the project tree.

Click **Next**.

Setting Row Filtering Options

The settings in the **Filtering** window are useful when all block results in are consistently the same non-Normal status. Select from **Error**, **Without grade**, **Blank** or **Outside**; all rows that consistently show the selected statuses will not be included in the exported file.

Click **Next**.

Setting Status Code Text Sequences

When a sub-blocked model is exported, non-Normal status codes can be represented in the exported file using custom text sequences.

When exporting sub-blocked models in Datamine format, both category and numeric status codes can use independent custom text sequences.

Click **Next**.

Selecting the Character Set

The selection you make will depend on the target for your exported file. You can choose a character set and see what changes will be made.

Click **Next**.

Renaming Items

When exporting a sub-blocked model in Datamine format, column names for the evaluated objects have a maximum length of 8 characters. Leapfrog Geothermal will recommend

truncated column names, but if you wish to use different abbreviations, click on the item's **New Name** to edit it.

Click **Next** to view a summary of the selected options, then click **Export** to save the file.

Presentation

Leapfrog Geothermal has a number of tools for displaying and presenting data for use in reports and presentations.

- Share models and data to View, a web-based model sharing platform that allows you to visualise 3D models and share them with collaborators. See [Uploading to View](#).
- Create and export cross sections, fence sections and serial sections. See [Sections](#).
- Create and export contours. See [Contour Lines](#).
- Render and save images for use outside of Leapfrog Geothermal. See [Rendered Images](#).
- Save scenes that demonstrate different aspects of the model and the model-building process. These scenes can then be saved as a movie or as a scene file that can be opened in Leapfrog Viewer. See [Saved Scenes](#).

See [Visualising Data](#) for information about the tools available in Leapfrog Geothermal for changing how data is displayed.

Uploading to View

View is a web-based model sharing platform. You can upload Leapfrog Geothermal data to View, visualise the data and organise it into slides. You can also share views with collaborators, all in your web browser, with data saved securely to the cloud. All your collaborators need is a My Leapfrog ID; a Leapfrog Geothermal licence is not required.

There are two workflows for uploading data from Leapfrog Geothermal to View, uploading the data currently displayed in the 3D scene and uploading saved scenes. Both techniques are described below, but first it is important to understand how View handles data objects uploaded from Leapfrog Geothermal.

In this Leapfrog Geothermal scene, we have a number of data objects, including a topography, drilling data, a geological model and its contact surfaces, plus grade shells from a numeric model. Data is sliced.

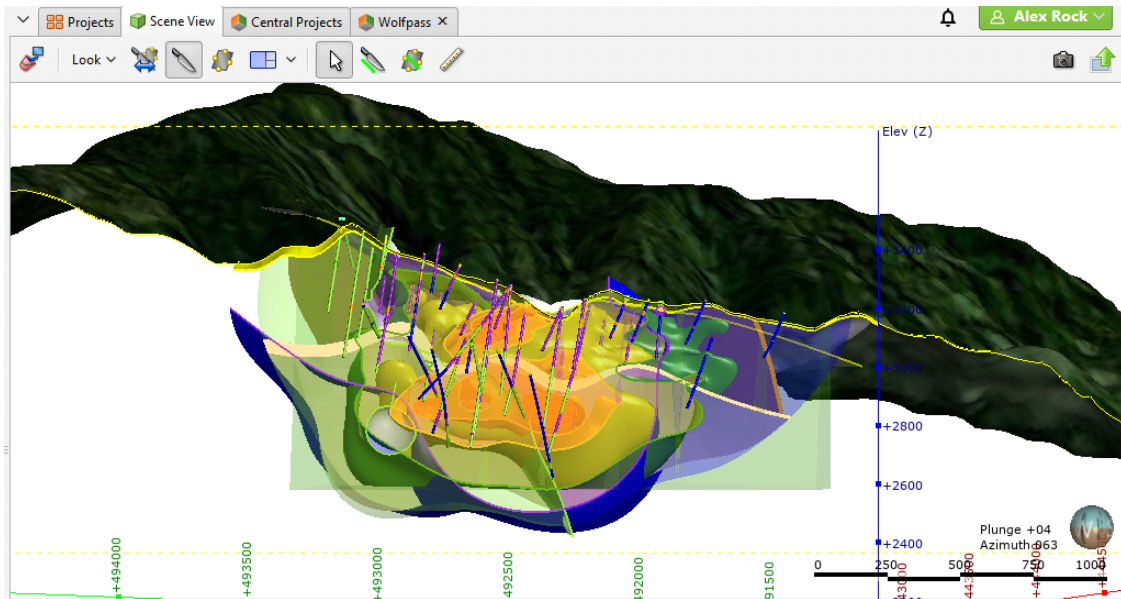

In View, all elements from the Leapfrog Geothermal scene are displayed in the initial view, which is unsliced. View's slice tool is similar to the slicer in Leapfrog Geothermal, and you can also rotate, pan and zoom the view and measure elements.

With the **Elements** list, you can select which objects to display and how they are displayed:

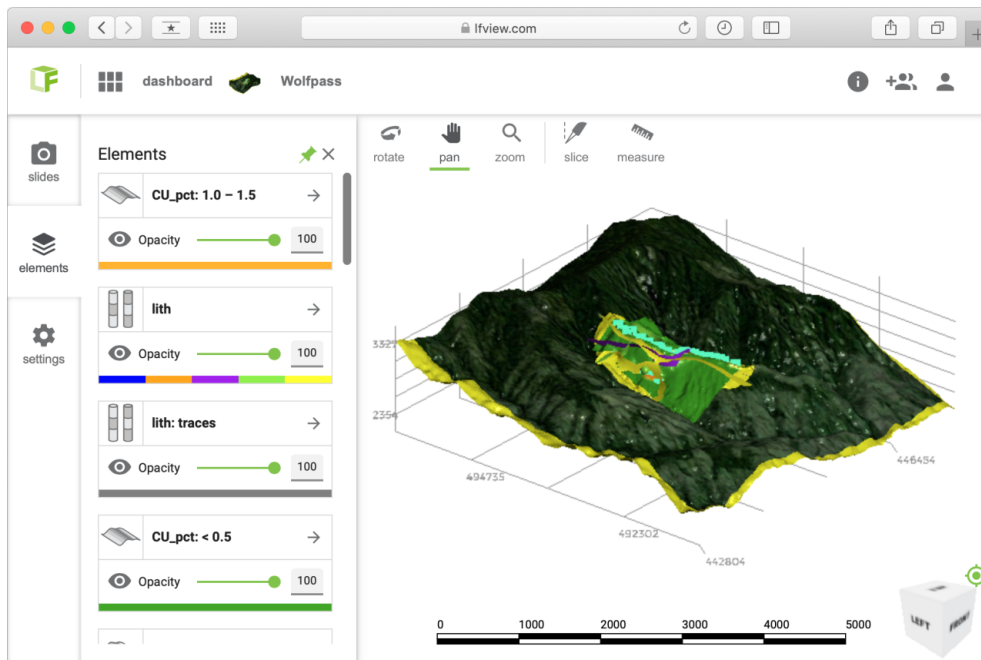

Once you have set up a view, save it as a slide. In this way, you can organise your data to tell a story and invite feedback from collaborators.

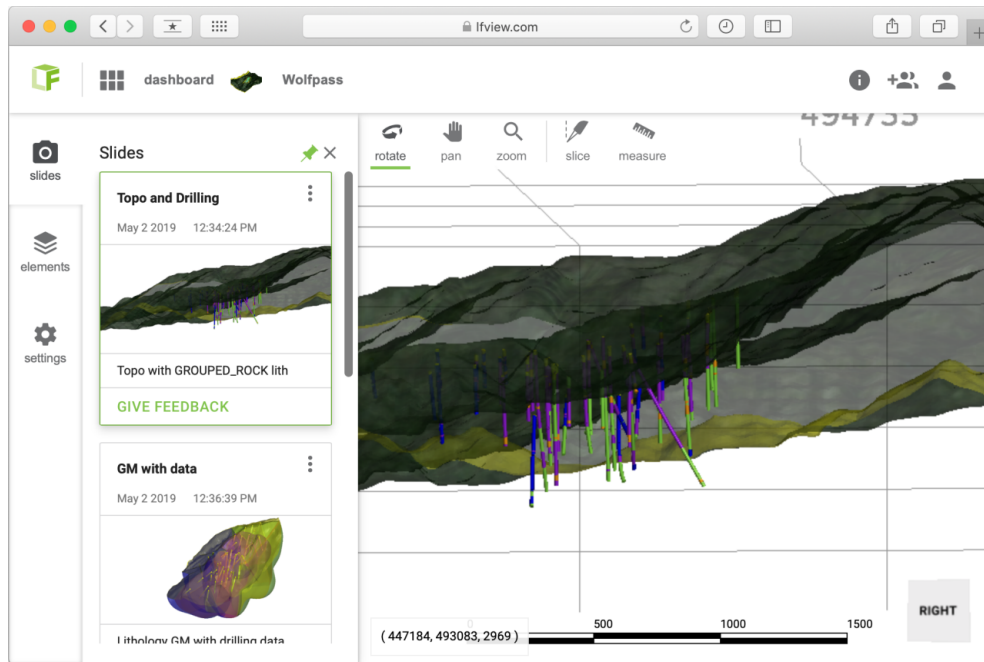

If you have permission to edit the view, you can add feedback and annotations and can create new slides:

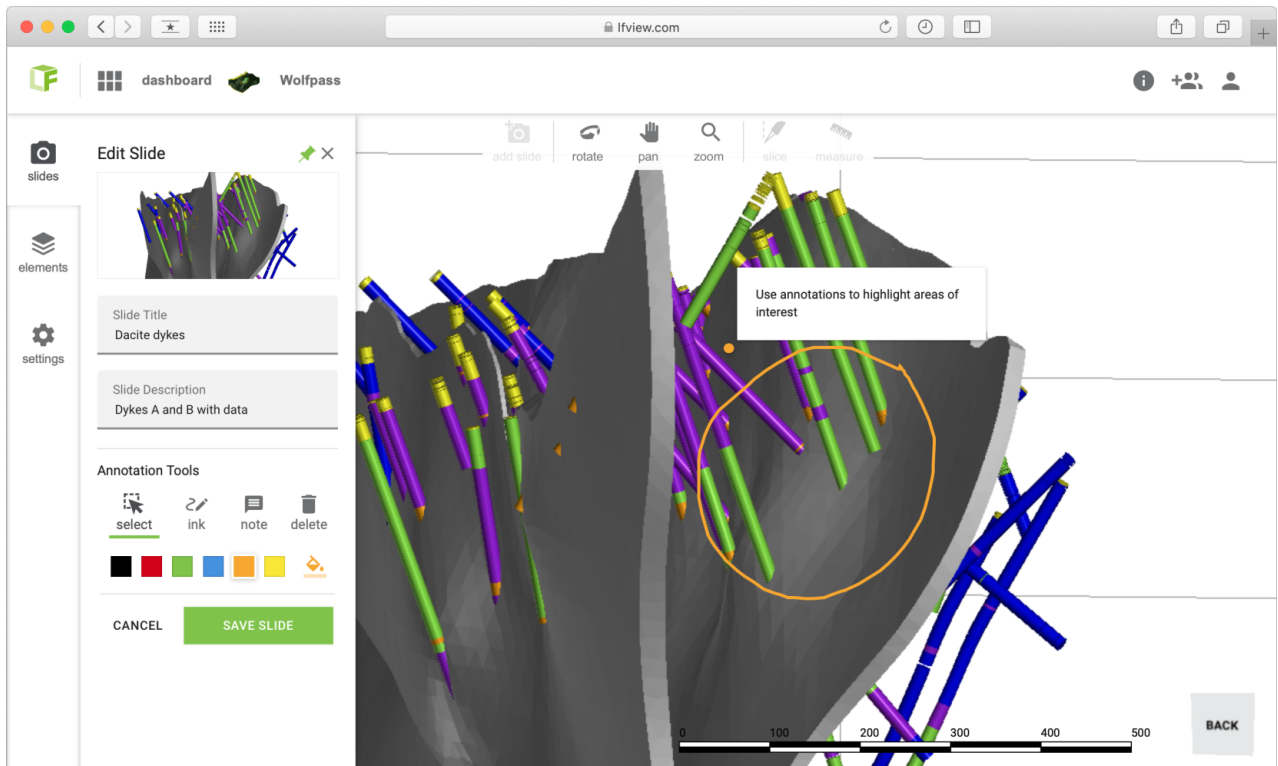

To learn more about using View, visit lfview.com, where you can explore the View gallery and see what's possible:

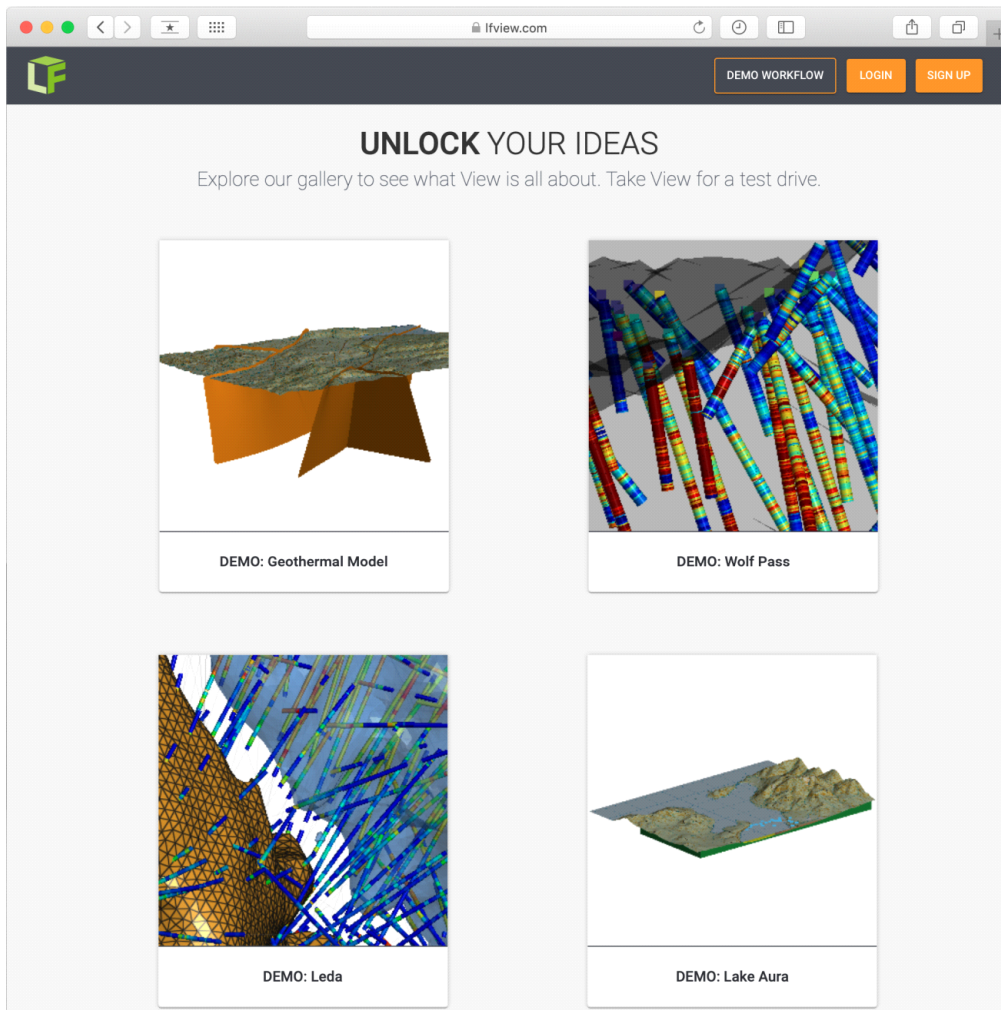

The rest of this topic describes:

- [Signing in to View](#)
- [Uploading to View](#)
- [Troubleshooting Connectivity Issues](#)

Signing in to View

Signing in to My Leapfrog via the **User Identity** menu also signs you in to View.

To enable uploading to View, click on the **Leapfrog Geothermal** menu and then on **Settings > User Interface**. Tick the box for **Show View upload**. The **View** button () will be displayed in the **Scene View** toolbar.

Uploading to View

There are two options for uploading to View:

- Uploading the current 3D view
- Uploading saved scenes

When selecting the data you will upload to View, think about the slides you wish to make in View.

Uploading the 3D View

The first option for uploading to View is to upload some or all of the objects in the 3D scene. To do this, click the **View** button (📁) in the toolbar:

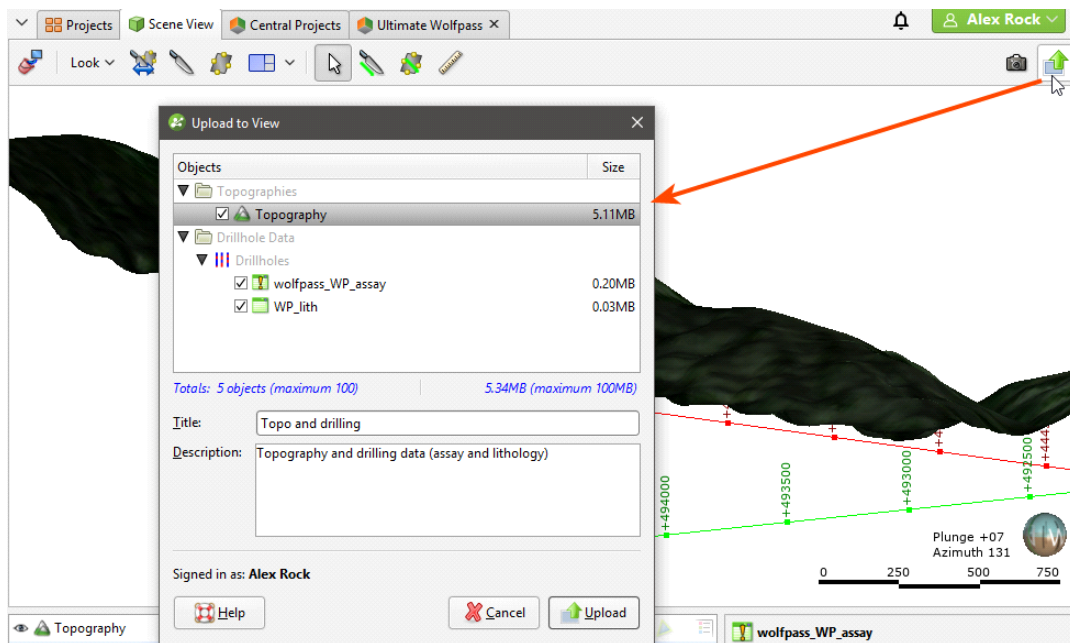

A list of the objects currently in the scene is displayed, along with information about the upload size for each object. Objects that are visible in the scene will automatically be selected, whereas any hidden objects will appear in the list but will not be selected.

If an object in the scene does not appear in the list, it is because the upload of that type of object to View is not supported at this time.

The maximum number of objects and the maximum amount of data that can be uploaded are displayed in the window, so if your scene contains large objects or too many objects, you can select which ones you wish to upload.

When uploading category data columns to View, there is a limit to how many unique codes can be uploaded. If your category data is displaying more than 250 unique codes, consider simplifying your data before uploading to View.

Once you have chosen which objects you want to upload and entered information about the view, click the **Upload** button.

Upload progress is shown in the notifications menu:

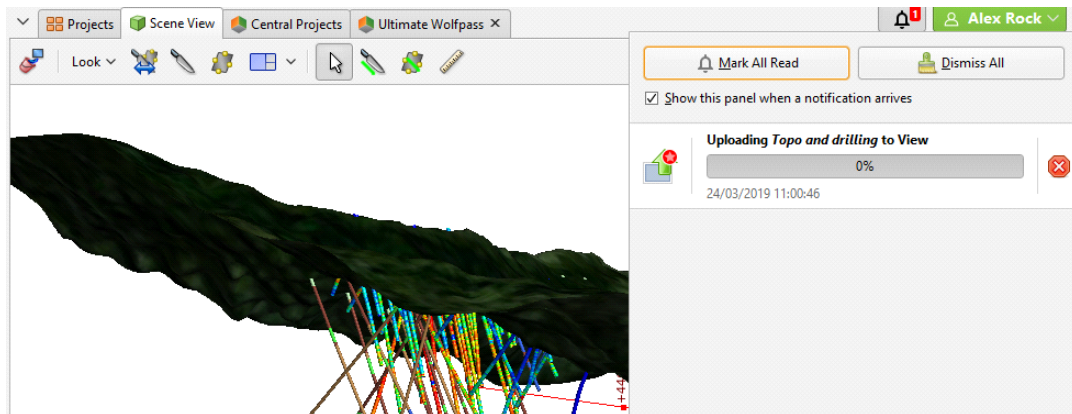

When the upload is complete, a link to View will be displayed in the notification list:

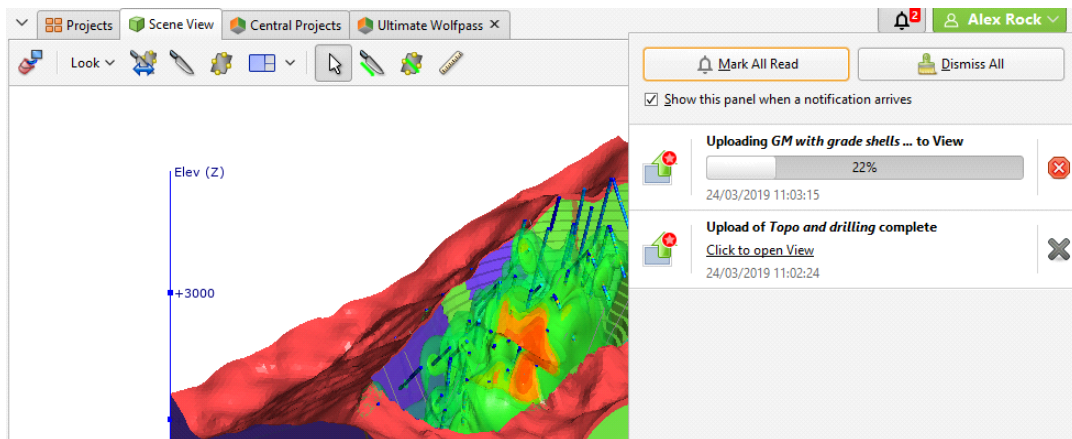

Notifications persist for the duration of your Leapfrog Geothermal session; all notifications are cleared when you exit Leapfrog Geothermal.

Uploading Saved Scenes

To upload one of the scenes in the **Saved Scenes and Movies** folder, right-click on the scene and select **Upload to View**. The process is the same as described in [Uploading the 3D View](#) above.

Troubleshooting Connectivity Issues

Leapfrog Start checks to see if your network will support the connection of Leapfrog web-based services to your desktop applications. If you are having trouble with your connection to View, see [Checking Connectivity with Leapfrog Start](#).

Sections

There are three types of sections in Leapfrog Geothermal:

- A typical cross section is a vertical plane with an image or geologic cross section applied to it. In Leapfrog Geothermal, this type of cross section can be created directly in the scene, from the slicer or from an imported image.
- A fence section deviates. In Leapfrog Geothermal, a fence section can be created from a polyline drawn in the scene or from any line object in the project.
- A serial section is a series of typical cross sections taken at an offset from a single base section.

Evaluating on Sections

Different objects in the project can be evaluated on sections, as described in Evaluations. Such objects include:

- Geological models
- Numeric models
- Distance functions
- Surfaces
- GIS lines
- Polylines
- Combined models

When evaluating objects on sections, you can limit the evaluation to the section extents. To do this, enable the **Clip evaluations to section extents** option when selecting what objects you are evaluating.

Block models can be evaluated on cross sections but not on serial sections and fence sections. Objects evaluated on sections can be included when the section is exported.

Exporting Sections

Sections can be exported in the following formats:

- DXF Files (11/12 [AC1009]) (*.dxf)
- Drawing Files (2013/LT2013) (*.dwg)
- Bentley Drawing Files (v8) (*.dgn)

Exporting a section as a DXF file (*.dxf) exports a series of DXF lines created from the intersection of the evaluation volumes and the section plane. The lines generated from each volume are saved as separate layers in the file.

For serial sections, the section will be exported in a single file with a collection of DXF lines based on intersections between the selected evaluation and the section planes.

To export a section in one of these formats, right-click on the section in the project tree and select **Export**. In the window that appears, select the evaluations you wish to export with the section:

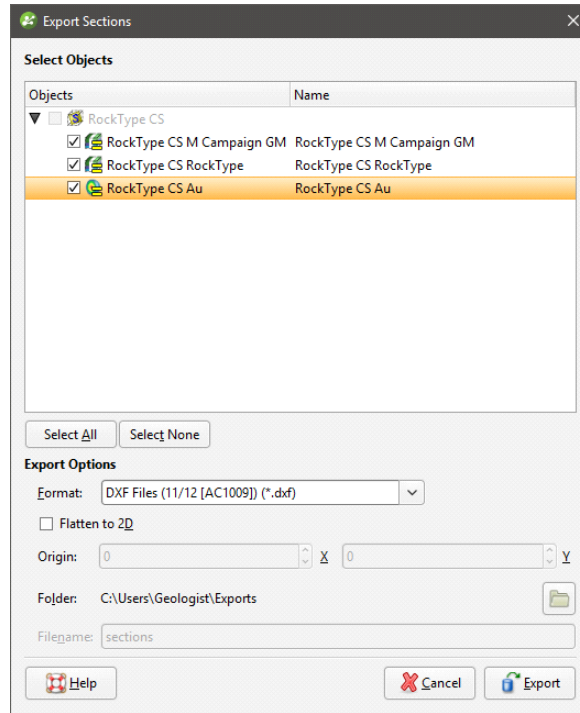

When you enable the **Flatten to 2D** option, the section will be flattened into the X-Y plane, making Z uniform across the section. You can change the origin, if required. The **Flatten to 2D** export option is available for:

- Regular cross sections
- Cross sections created from images
- Child sections of serial and alignment sections

Enter a filename and location, then click **Save**.

Exporting Section Layouts

Another way to export a section is to create a section layout and then export it as a PDF file (*.pdf), Scalable Vector Graphics file (*.svg), PNG image (*.png) or GeoTIFF (*.tiff, *.tif). This option is more flexible than exporting the section as a DXF file as you have more control over the section layout. You can customise the page layout and include multiple evaluations and annotations. For typical cross sections and serial sections, you can also display wells and planned wells. See the [Section Layouts](#) topic for information in using the section editor.

Once you have finished adjusting the section layout, you can export it in one of the following formats:

- PDF Files (*.pdf)
- Scalable Vector Graphics Files (*.svg)
- PNG Image Files (*.png)
- GeoTIFF Files (*.tiff, *.tif)

Click the **Save and Export** button (📄) at the top of the window. You will be prompted for a filename and location.

All selected sections can be exported as a single PDF or individually in PDF file (*.pdf), Scalable Vector Graphics file (*.svg), PNG image (*.png) or GeoTIFF (*.tiff, *.tif) formats. When section layouts are exported individually, all outputs can be combined into a zip archive. To do this, right-click on the **Cross Sections and Contours** folder and select **Batch Export Layouts**.

In the window that appears, selection the layouts you wish to export, then select a format. If you select a format other than Single PDF, you can combine all outputs into a zip archive. Select where you wish to save the outputs, then click **Export**. Progress will be displayed at the top of the **Batch Export Section Layouts** window:

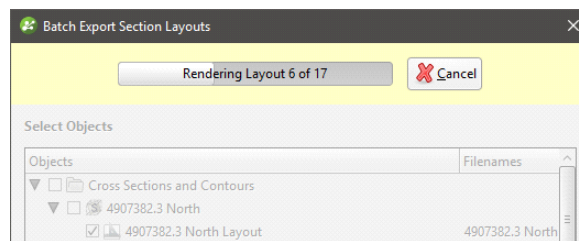

Creating Cross Sections

To create a cross section in the scene, add a model to the scene. Next, right-click on the **Cross Sections and Contours** folder and select **New Cross Section**. The **New Cross Section** window will appear, together with a section plane and controls in the scene that let you adjust the position of the section plane:

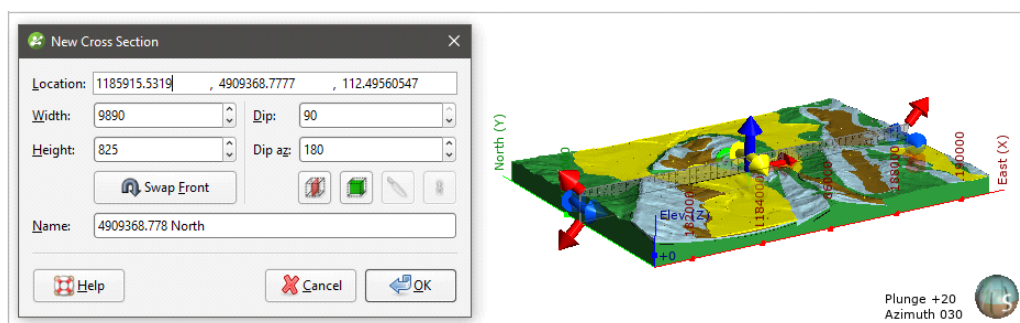

If the slicer is already in the scene when you select **New Cross Section**, the position of the slicer will be used to define the initial orientation of the section. This is an effective way of creating a section from the slicer: add the model to the scene, draw a slice and then create a

cross section.

The front (F) and back (B) of the section plane is indicated in the scene. To swap the front and back, click the **Swap Front** button (🔄).

Use the handles in the scene to position the section plane. The handles work in the same manner as the moving plane controls, as described in [The Moving Plane](#).

Two buttons in the **New Cross Section** window let you create a cross section that is aligned north-to-south (📍) or east-to-west (📍):

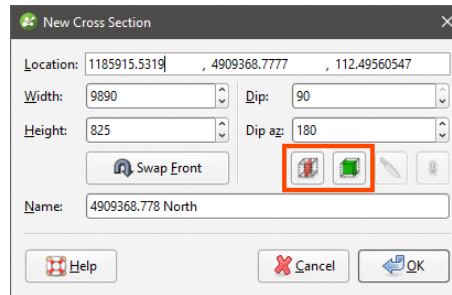

The other two buttons are active when the slicer is in the scene. Clicking the **Set section to slicer** button (📍) creates a cross section from the position of the slicer in the scene. When the **Lock section to slicer** button (🔒) is enabled, moving the position of the slicer will update the position of the cross section in the **New Cross Section** window.

Once the section plane is positioned as required, click **OK** to create the new cross section, which will appear in the **Cross Sections and Contours** folder. Display it by clearing the scene, then adding the cross section to the scene.

Many objects in a project can be evaluated on cross sections, as described in [Evaluations](#). Such objects include:

- Geological models
- Interpolants
- Distance functions
- Surfaces
- GIS lines
- Polylines

Objects evaluated on a cross section or fence section can be included when the section is exported.

Importing Cross Sections

To import an image and use it to create a new cross section, right-click on the **Cross Sections and Contours** folder and select **New Cross Section From Image**. Leapfrog Geothermal supports the following file formats for creating cross sections:

- PNG files (*.png)
- JPEG files (*.jpg, *.jpeg)
- TIFF and GeoTIFF files (*.tiff, *.tif)
- Windows Bitmap files (*.bmp)
- Graphics Interchange Format files (*.gif)

Select an image, then click **Open**. The **Import Section Image** window will be displayed.

Cropping the image to only the area of interest will reduce video RAM usage and may improve graphics performance. To crop the image, click on the **Crop Image** button (📏) at the top of the window, then drag around the part of the image you wish to use. Click on the **Remove Crop** button (🗑️) to clear the cropping.

If the image is georeferenced and you are satisfied that this information is correct, click **Import**. The new cross section will be created and added to the **Cross Sections and Contours** folder.

If the image does not contain georeferencing information, you will need to add it manually by adding reference markers and then entering coordinates. First, tick the box for any **Section Type** options as these constrain the markers that need to be set. For example, selecting **East facing section** means you will only need to enter the **East (X)** coordinates once.

To add coordinates to the image, click on a marker and move it to the required location. Then enter the coordinates for the marker:

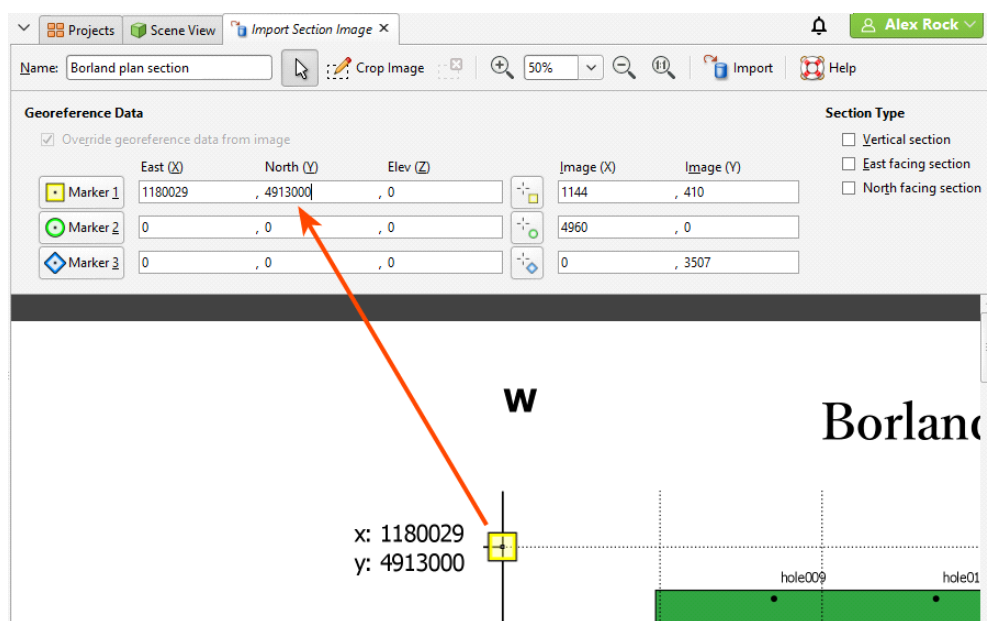

The **Image (X)** and **Image (Y)** fields give you fine control over the location of the marker on the image.

If the image is georeferenced and you wish to discard the information, tick the **Override georeference data from image** box and edit the markers.

Once the coordinates for each marker have been set, click **Import**. The new cross section will be created and added to the **Cross Sections and Contours** folder. Display it by dragging it into the scene or by right-clicking on the cross section and selecting **View Object**.

Once you have georeferenced an image, you can export it as a GeoTIFF. To do this, right-click on it in the project tree and select **Export**. You will be prompted for a filename and location. Click **Save**.

Once you have created a cross section, you can edit it or use it to evaluate geological models, interpolants, distance functions and surfaces. See [Evaluations](#).

Fence Sections

You can draw a polyline or use any existing line object in the project to create a cross section that deviates. To do this, right-click on the **Cross Sections and Contours** folder and select **New Fence Section**. The **New Fence Section** window will be displayed:

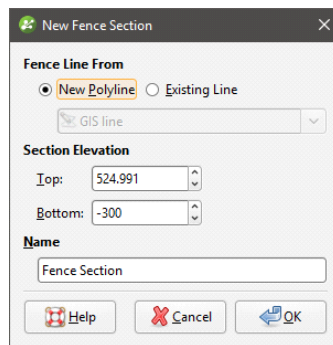

You can draw the polyline in the scene directly by selecting the **New Polyline** option. You can also use any polyline in the project by selecting the **Existing Polyline** option.

Only GIS lines, polylines imported into Leapfrog Geothermal or polylines created using the straight line drawing tool can be used to create fence sections.

Click **OK** to create the fence section. If you chose to create a **New Polyline**, the drawing controls will appear in the scene and you can begin drawing, as described in [Drawing in the Scene](#).

The fence section will appear under the **Cross Sections and Contours** folder and you can edit it by double-clicking on it. You can also use it to evaluate different objects in the project, as described in [Evaluations](#). Such objects include:

- Geological models
- Interpolants
- Distance functions
- Surfaces

- GIS lines
- Polylines

If you create a section layout for a fence section, you can include multiple evaluations and annotations on the section layout. See [Section Layouts](#).

Serial Sections

This topic describes the process of creating a serial section, which is a series of cross sections taken at an offset from a single base section. The topic is divided into:

- [Setting the Base Section](#)
- [Setting the Offset Sections](#)
- [The Serial Section in the Project Tree](#)
- [Displaying a Serial Section](#)
- [Exporting a Serial Section](#)

To create a serial section, add a model to the scene. Next, right-click on the **Cross Sections and Contours** folder and select **New Serial Section**. The **New Serial Section** window will appear and planes representing the base section and the offset sections will be added to the scene:

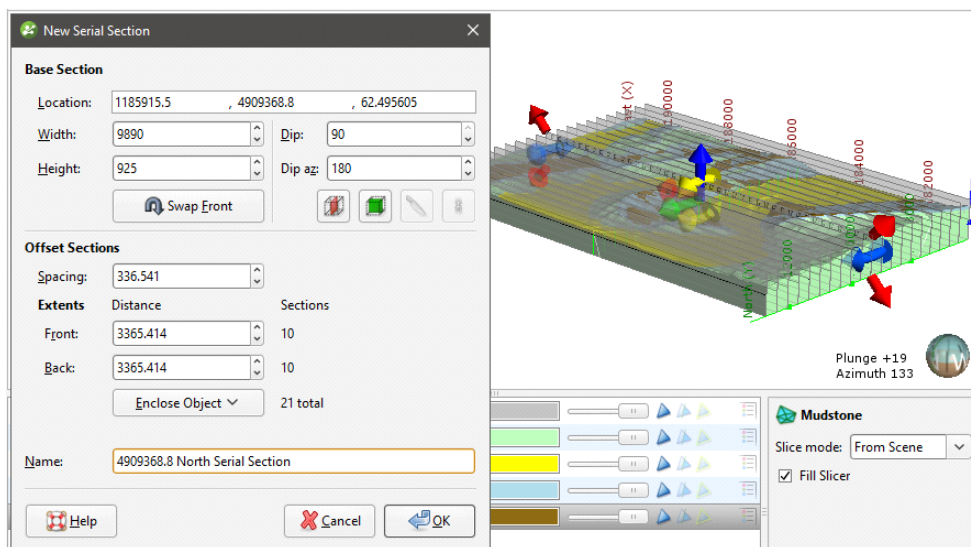

If the slicer is already in the scene when you select **New Serial Section**, the position of the slicer will be used to define the initial orientation of the base section.

Setting the Base Section

The handles in the scene control the position of the base section and work in the same manner as the moving plane controls (see [The Moving Plane](#)).

The front (F) and back (B) of the base section plane are indicated in the scene. To swap the front and back, click the **Swap Front** button (🔄).

Two buttons in the **New Serial Section** window let you create a base section that is aligned north-to-south (📍) or east-to-west (📍). The other two buttons are active when the slicer is in the scene. Clicking the **Set section to slicer** button (📍) creates a cross section from the position of the slicer in the scene. When the **Lock section to slicer** button (🔒) is enabled, moving the position of the slicer will update the position of the cross section in the **New Serial Section** window.

Setting the Offset Sections

The number of offset sections is determined by the value of the **Spacing** setting and the **Front** and **Back Extents**:

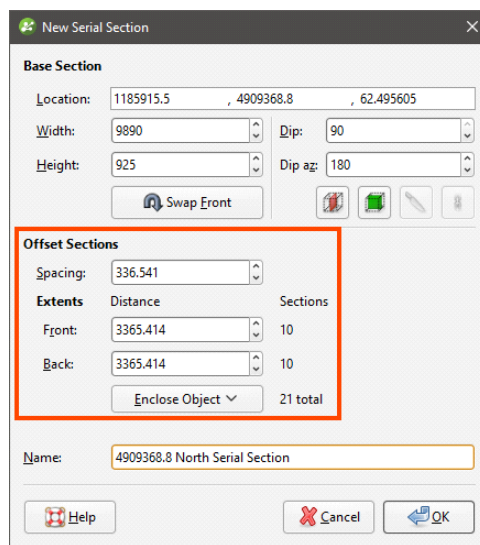

You can change the number of offset sections by:

- Changing the **Spacing** setting. The number of offset sections will be recalculated and updated in the scene.
- Changing the **Front** or **Back** settings. For example, increasing the **Front** setting adds an offset section on the front of the base section, increasing the extents by the value of **Spacing**.
- Changing the object used to define the extents. Select an object from the **Enclose Object** list. The base section will be moved to the centre of the selected object.

The Serial Section in the Project Tree

Click **OK** to create the section. In the project tree, the serial section includes the individual cross sections:

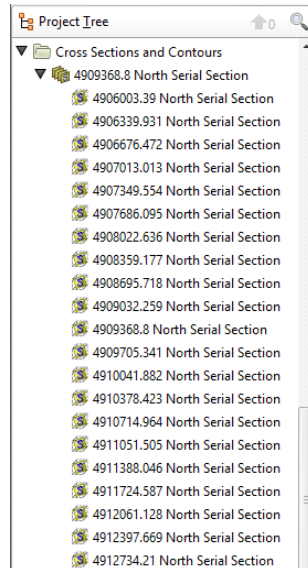

Many objects in a project can be evaluated on serial sections, as described in [Evaluations](#). Such objects include:

- Geological models
- Interpolants
- Distance functions
- Surfaces
- GIS lines
- Polylines

Displaying a Serial Section

When you display a serial section in the scene, you can add the slicer to the scene and use it to move easily between the sections in the stack. To do this, click on the slicer in the shape list, then select the base section from the **Set to** list:

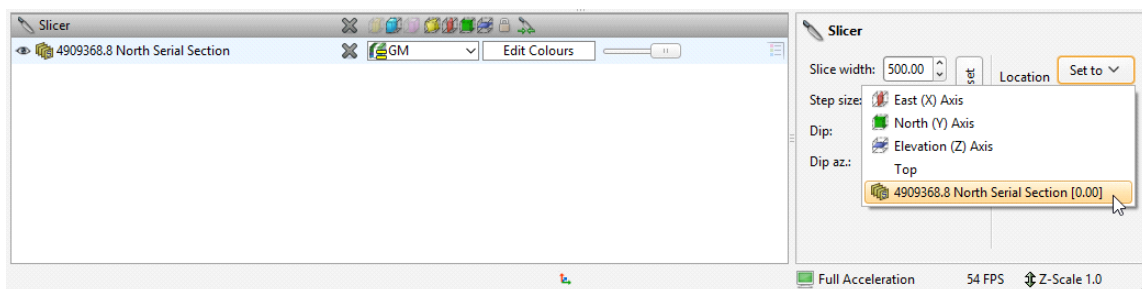

Next, set the **Step size** to the **Spacing** setting used to create the section. You can then use the < and > keys to view each individual cross section.

Exporting a Serial Section

The options for exporting serial sections differ for the section itself and the offset sections:

- A serial section cannot be used to create a section layout. When exported as a DXF file, the serial section will be exported in a single file with a collection of DXF lines based on intersections between the selected evaluation and the section planes.
- The offset sections that make up a serial section can be exported in DXF format or as a section layout. See [Exporting Sections](#) and [Section Layouts](#) for more information.

Section Layouts

With the **Section Layout Editor**, you can create a section layout for an existing section and then export the section. You can customise the section layout by:

- Adding models, surfaces and lines the section has been evaluated against
- Adding wells and planned wells
- Changing the page size, orientation and margins
- Adding titles, a scale bar, legends, annotations and images, such as a standard form or logo

The appearance of all objects can be customised without changing how objects from the project tree are displayed in the scene.

Section layouts can be displayed in the scene by dragging a layout into the scene:

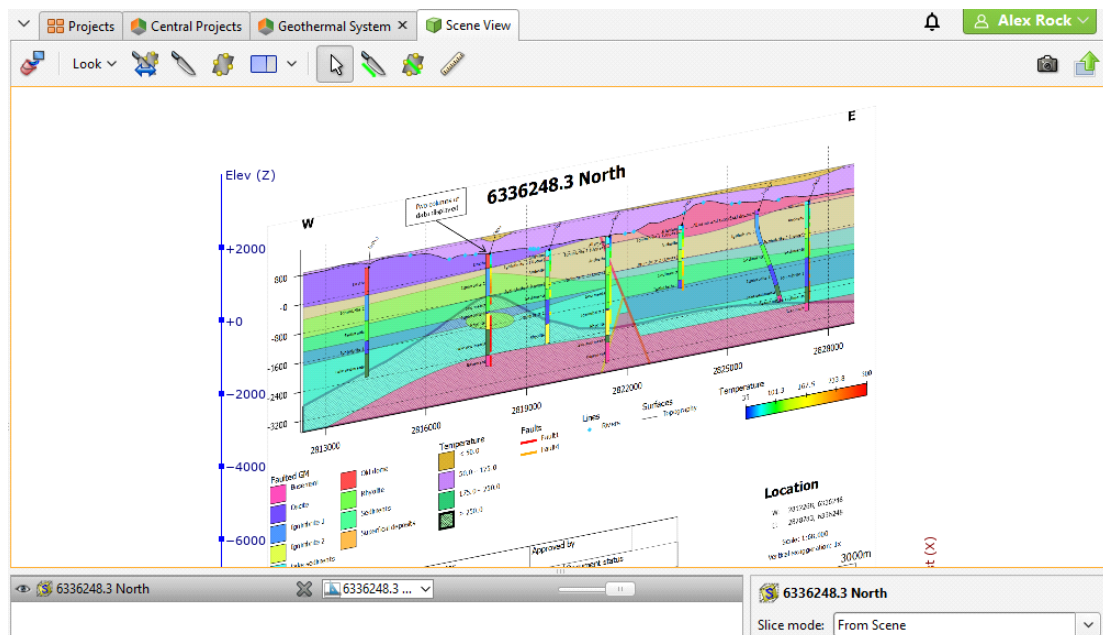

Some sections will be too large to display in the scene, which will be indicated in the section layout editor.

Displaying section layouts in the scene is useful when you are editing a section layout and wish to see the effect of changes. Detach the section layout tab from the main window and position it adjacent to the scene window. Periodically save your changes to the section layout to see the effects of those changes in the scene.

This topic describes how to work with section layouts. It is divided into:

- [Setting Up the Section](#)
- [Creating New Section Layouts](#)
- [Copying Section Layouts](#)
- [Working With the Section Layout Editor](#)

- [Changing Page Properties](#)
- [Changing the Basic Section Properties](#)
- [Organising Objects on the Section](#)
- [Setting Up the Legend](#)
- [Adding and Organising Annotations](#)

Setting Up the Section

Once you have created a section but before you start creating the section layout, take the following steps.

1. Check the section’s extents and orientation.

The initial dimensions of the section on the page are determined by the size of the section plane, and its orientation on the page is determined by the front (F) and back (B) faces of the section plane. Here, the front and back faces of the section have been swapped, which results in the section displayed on the page being flipped:

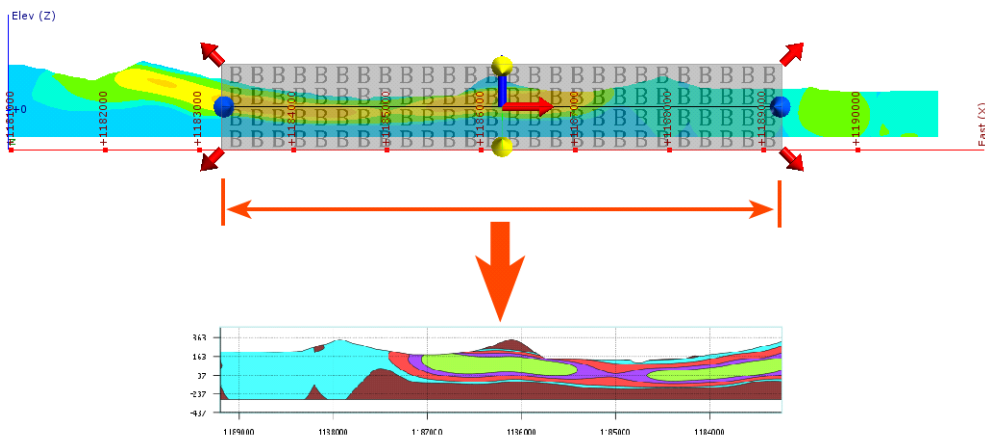

2. Check that the section has been evaluated against objects you wish to display on the page.
To do this, right-click on the section in the project tree and select **Evaluations** or **Evaluate Surface**.

3. Add planned wells to the project.

Planned wells can be displayed on the section, but these must be defined before you start the process of laying out the section.

Creating New Section Layouts

To create a new section layout, right-click on an existing section in the project tree and select **New Section Layout**. The **New Section Layout** window will appear, together with the **Section Layout Editor**:

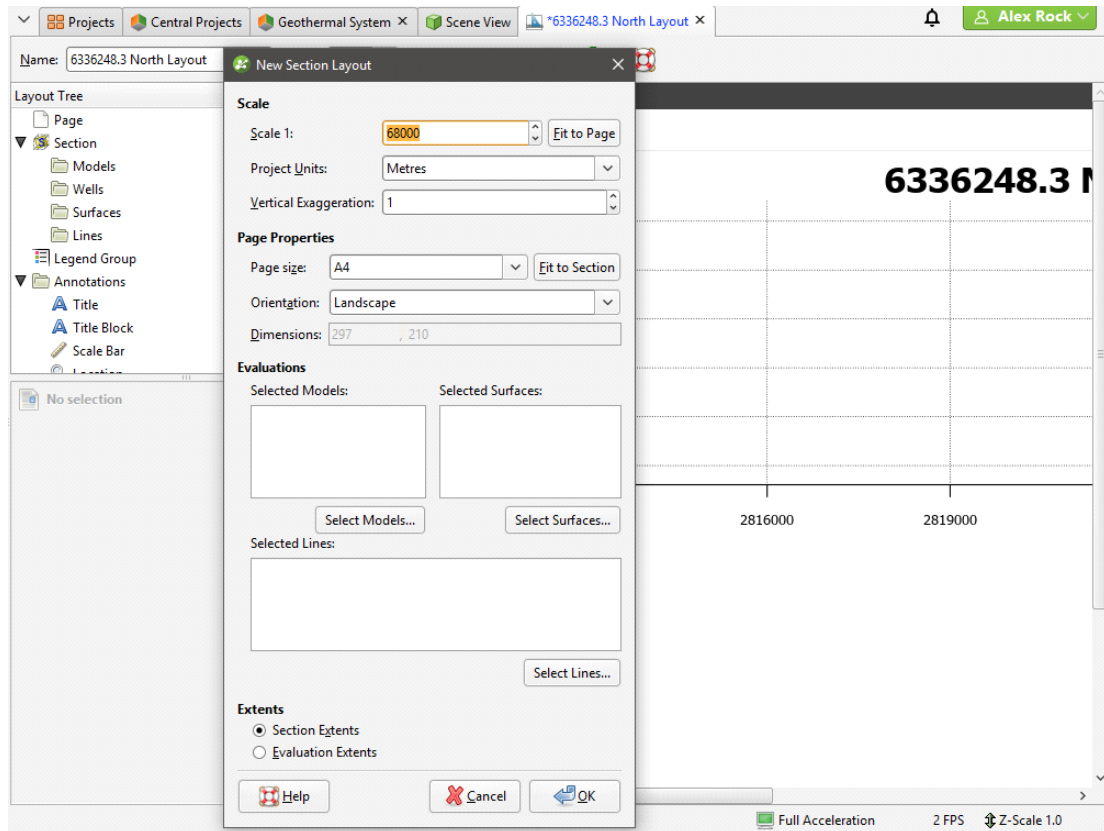

The settings in the **New Section Layout** window determine the basic section layout:

- The **Scale** settings determine the scale used to display the section on the page. If you want a specific page size, select **Fit to Page** to set a scale that best fits the page width. You will be able to change the page margins once you have closed the **New Section Layout** window.
- The **Page Properties** settings determine the page size and orientation. If you wish to use a specific **Scale**, select the **Orientation** required, then click **Fit to Section** to choose the best page size.
- For **Evaluations**, select from the models, surfaces and lines the section has been evaluated against. When you select an evaluation, it will be added to the preview.
- For **Extents**, choose whether to use the **Section Extents** or **Evaluation Extents**. If you wish to use the extents from a model evaluation, add only that model to the **Models**, **Surfaces** or **Lines** list, then select the **Evaluation Extents** option. Once you have closed this window, you will be able to add further models, surfaces and lines using the section layout editor.

As you change settings and add objects to the section, the preview in the **Section Layout Editor** window will be updated. All settings in the **New Section Layout** window can be changed once the layout has been created.

Click **OK** to close the **New Section Layout** window. You can then make further changes to the page layout in the **Section Layout Editor**. See [Working With the Section Layout Editor](#).

Copying Section Layouts

If you have already created a section layout and wish to reuse it, you can copy it to other sections.

Copying a section layout copies the evaluations used in the original section layout, together with the page size and orientation and the position of the **Layout Tree** objects on the page. How models, surfaces and wells are copied depends on the section to which the layout is being copied:

- All models and surfaces that can be displayed on the section will be copied.
- The wells copied to the layout will depend on the type of section the layout is being copied from and whether or not a filter is set for the layout:
 - If no distance filter was set for the original layout, all wells selected for the original layout will be copied.
 - If a distance filter was applied to the original section, the filter will be applied and wells selected that are within that distance of the section to which the layout is being copied.
 - When the original layout is from a fence section, well evaluations will not be copied with the section layout.

To copy a layout, right-click on the layout you wish to copy and select **Copy Layout To**. In the window that appears, a summary of the information that will be copied is displayed so you can see what information will be copied to the selected sections. Move the sections you wish to copy the layout to into the **Selected Sections** list, then click **OK**. A copy of the layout will appear in the project tree under each section you selected. The layout copies are not linked to the original layout and so will not be updated when the original is updated.

Copying section layouts to multiple sections can result in numerous section layouts in a project, which can be difficult to work with. The recommended workflow for creating a section layout that you intend to make multiple copies of is to first get the layout right on one section before copying it to other sections.

Working With the Section Layout Editor

In **Section Layout Editor**, the **Layout Tree** shows the different layers that can be added to the page. The different parts of the **Layout Tree** as they relate to the page preview are shown below:

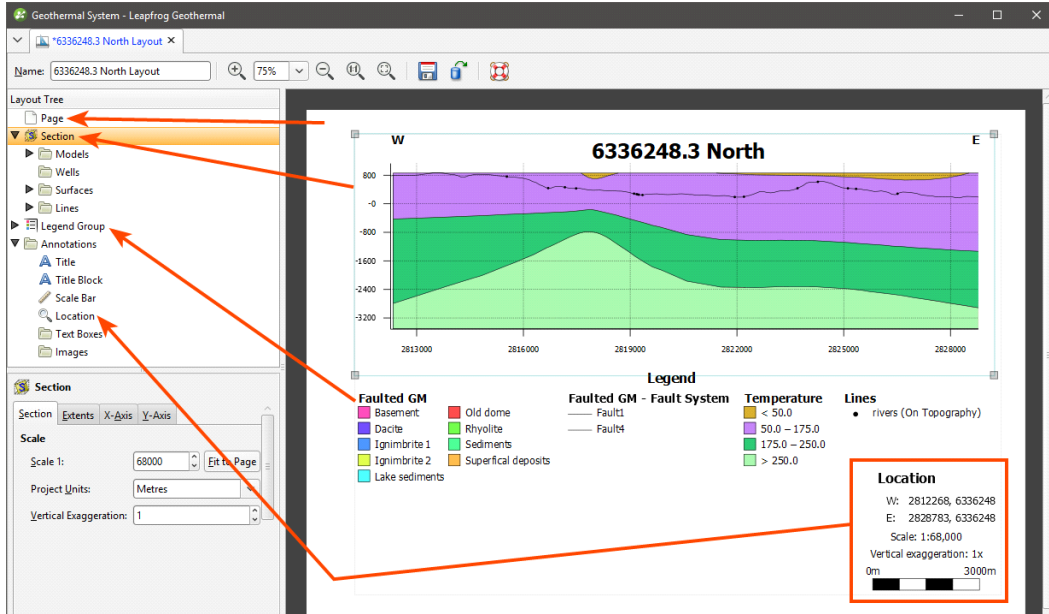

When you select an object in the layout tree, it will be highlighted by a blue line on the page. In the example above, the **Section** object is selected.

Click on an object in the page preview to move or resize it. This will also select the object in the **Layout Tree** and you can see what properties can be changed. For example, in the preview, click on the **Title** to view its styling options:

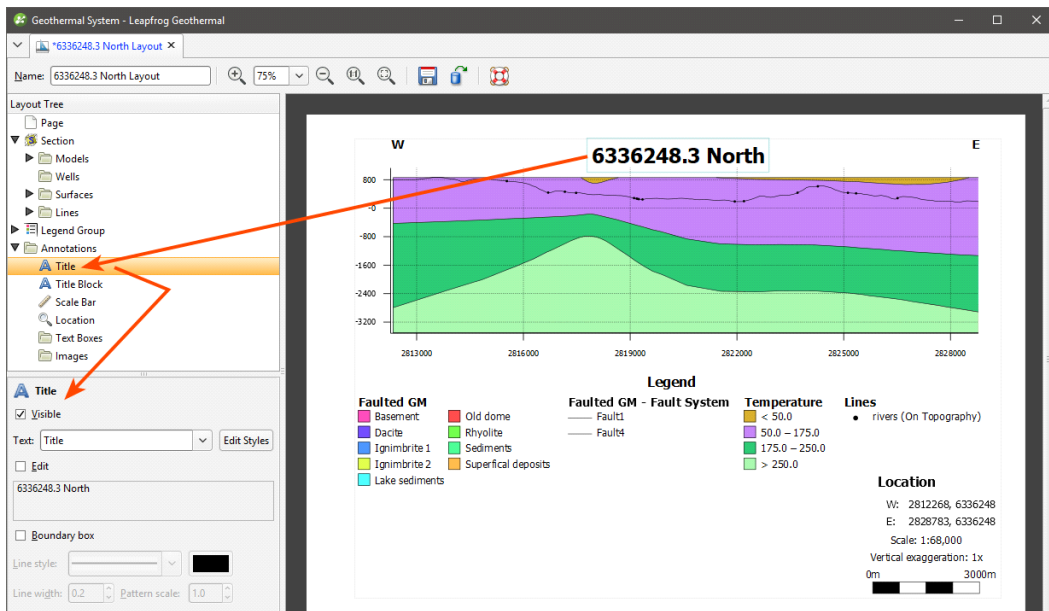

Text displayed in the section layout is controlled by a style sheet that can be accessed whenever you are editing a text object. For example, clicking on **Edit Styles** for the **Title** opens the list of

Text Styles with the **Title** selected, but also allows you to change the appearance of styles used for other text objects visible in the preview:

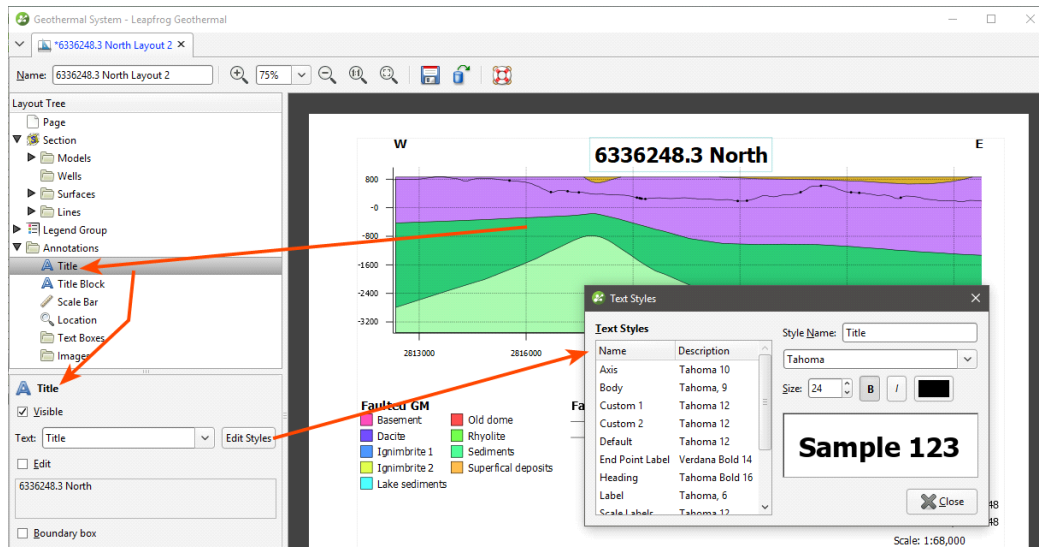

Changing Page Properties

In the **Layout Tree**, click on **Page** to change the **Page Size**, **Orientation** and **Margins**:

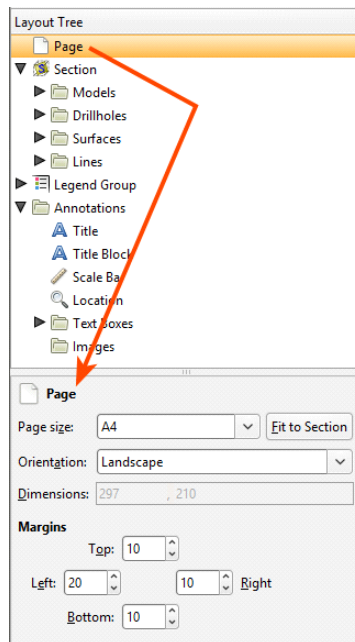

If you wish to use a specific **Scale**, select the **Orientation** required, then click **Fit to Section** to choose the best page size.

Changing the Basic Section Properties

To change the section layout's basic properties, click on the **Section** object in the **Layout Tree**. In the **Section** tab, you can change the scale and units used in the layout and the amount of **Vertical Exaggeration**:

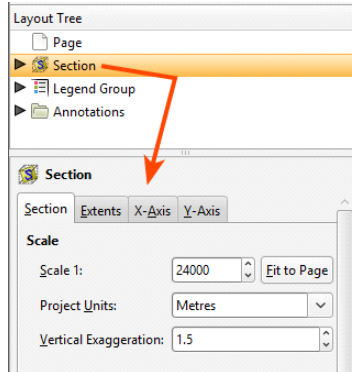

For the **Scale**, you can enter a specific value to use in displaying the section on the page, or, if you want a specific page size, select **Fit to Page** to set a scale that best fits the page width.

If you want to change the page size and the margins used, click on the **Page** object.

To change the size of the section contents (models, wells, surfaces and lines) on the page, click on the **Extents** tab:

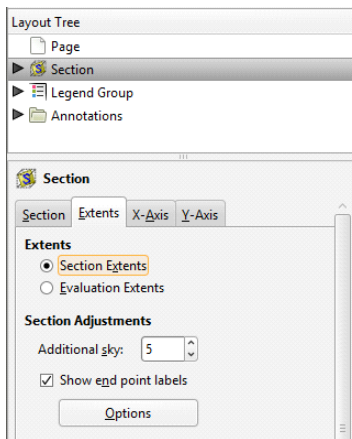

For **Extents**, choose whether to use the **Section Extents** or **Evaluation Extents**.

You may wish to add more space above the section, especially if you will be adding wells to the section and need extra space for the collar labels. To do this, change the **Additional sky** setting. These images show the effects of two different **Additional sky** settings:

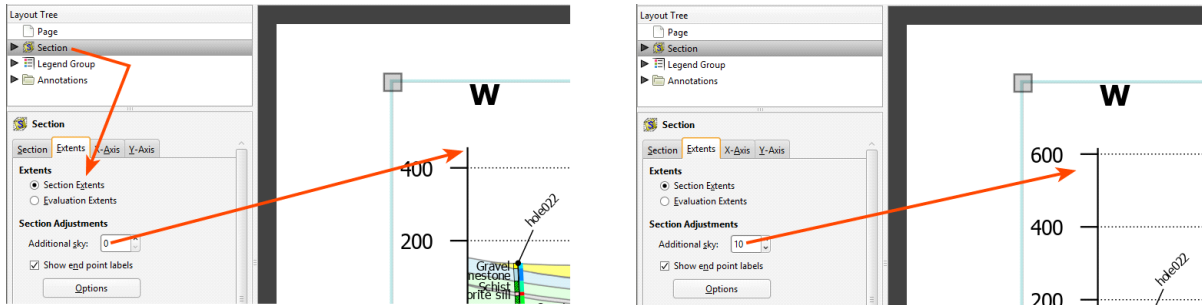

Enable **Show end point labels** to display the section's end points as text:

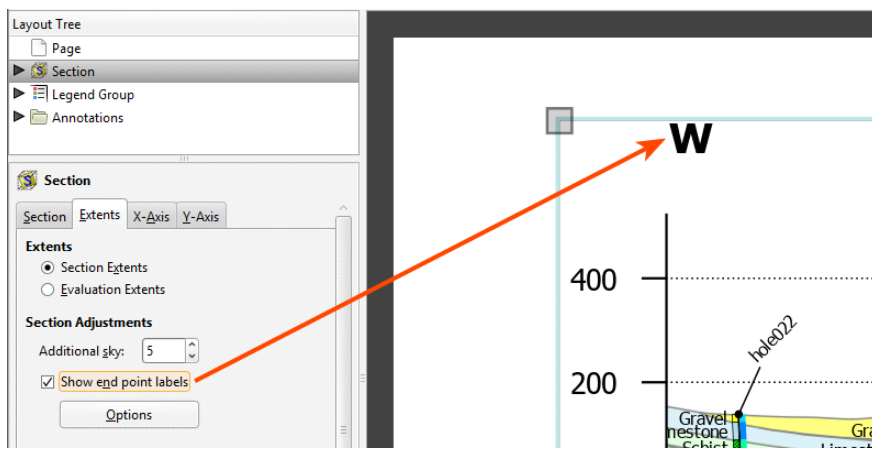

Click **Options** to change how the end points are displayed relative to the section's axes. There are two options that control where the end points are displayed, **Points above** and **Points aligned inside**. The **Points above** setting determines whether the end points are displayed above or beneath the axes. Note here the difference between **Points above** being disabled and enabled:

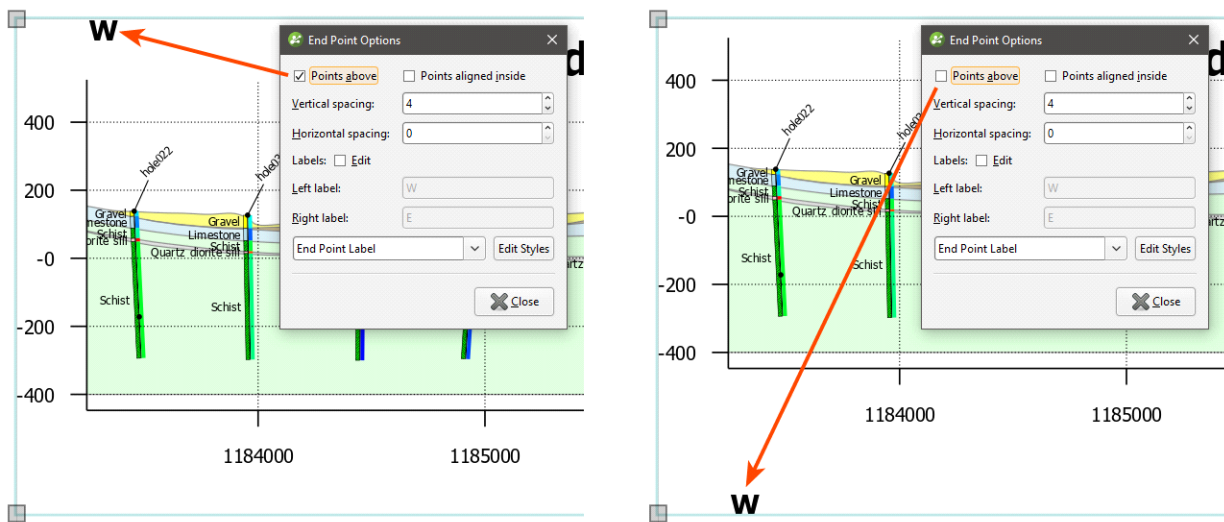

The **Points aligned inside** setting determines whether the end points are displayed inside or outside the section's axes:

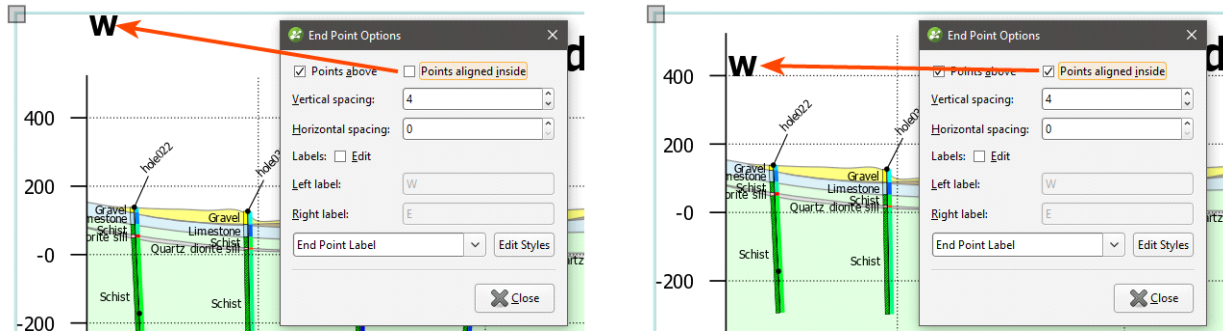

You can also change the spacing between the end point labels and the section axes.

Edit the text used to display the end points by enabling the **Edit** box and then changing the text. You can edit the style used for displaying the labels by clicking **Edit Styles** to change the style or by selecting a different style from the dropdown list.

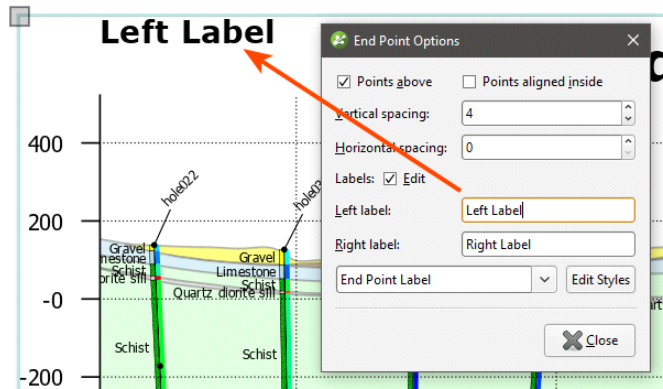

To change how the axes are displayed, click on either the **X-Axis** tab or the **Y-Axis** tab. One of the options available for the axes is how much information is displayed for the **Real World Coordinates** on each axis:

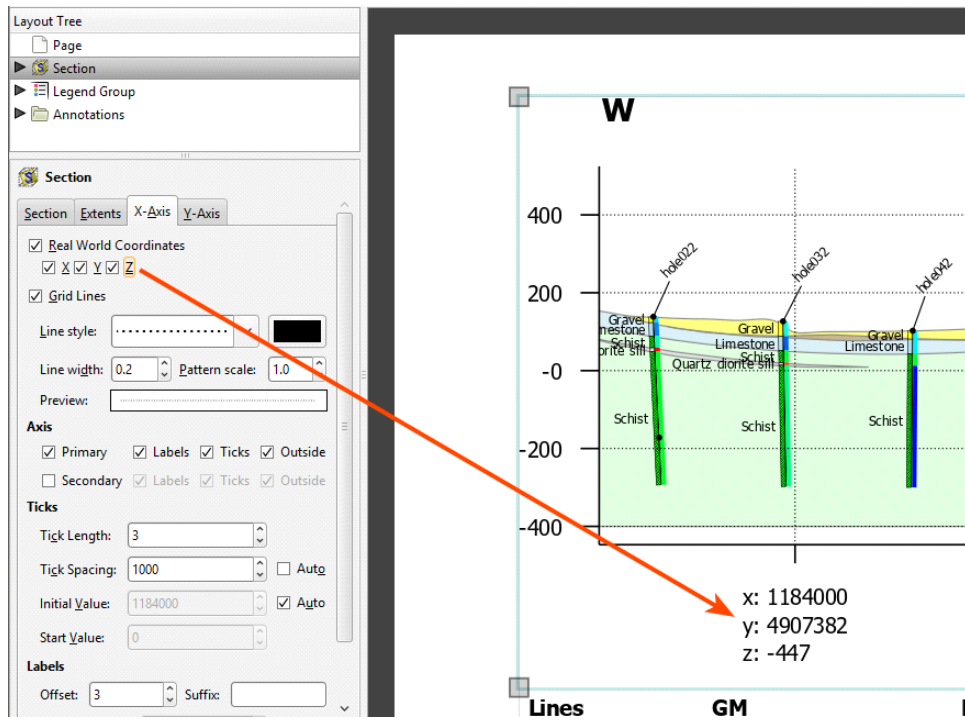

You can also change how **Grid Lines** are displayed, including the **Line style**, **Line width**, **Pattern scale** and colour. A **Preview** is displayed and the grid lines are updated in the section preview.

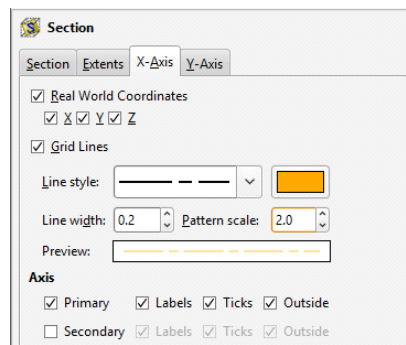

By default, the axes are displayed only on the left-hand side and along the bottom of the section. To display axes along the right-hand side and above the section, tick the **Secondary** option.

For the **Ticks**, Leapfrog Geothermal automatically calculates an **Initial Value**:

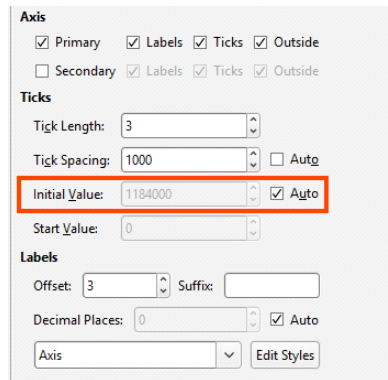

If you wish to change this, disable **Auto** and enter the required value.

If you wish to set an X-axis **Start Value** other than 0, you must first disable the **Real World Coordinates** option:

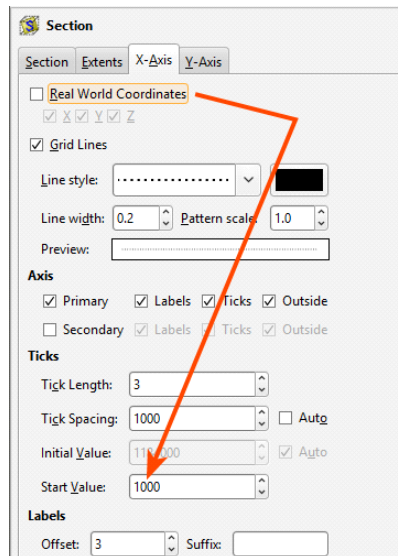

Edit the style used for displaying the axis labels by clicking **Edit Styles** to change the style or by selecting a different style from the dropdown list.

Organising Objects on the Section

The folders below the **Section** object are used to add and organise models, wells, surfaces and lines and to customise how they are displayed:

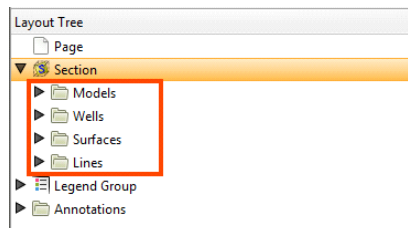

If you selected models, surfaces and lines when you created the section, they will appear in one of these folders. You can add new objects by right-clicking on a folder and selecting an **Add** option:

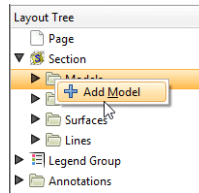

- For the **Add Model**, **Add Surface** and **Add Line** options, you will be able to choose from the objects that have been evaluated on the section. See [Evaluating on Sections](#) for more information.
- For the **Wells** folder, there are two options, **Add Wells** and **Add Planned Wells**. For both options, you can choose from the wells and planned wells available in the project; it is not necessary to evaluate these onto the section before you can add them to the layout.

Models, wells, surfaces and lines occupy the same space on the section layout, and opacity settings and an object's position among the layers can be used changed to emphasise relevant information. To change the order of objects on the page, right-click on them and select an option:

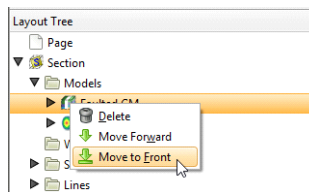

Models will always be among the lower layers, with lines on top of all the other layers.

You can remove objects from the layout by right-clicking on them and selecting **Delete**.

To change the opacity of an object, click on it, then adjust the object's **Opacity** using the slider:

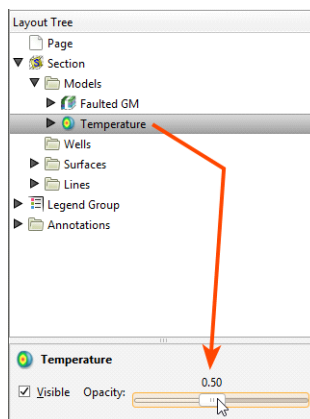

Adding and Styling Models

The **Models** folder contains all models that have been added to the section layout. To add another model, first make sure it has been evaluated on the section, then right-click on the **Models** folder and select **Add Model**. Select from those available and click **OK**.

When you display multiple models on the section, you can end up with a large number of objects that obscure the information you want to emphasise. You can:

- Use the **Opacity** setting for each model to expose and emphasise information.
- Right-click on the models to move them up or down in the layer hierarchy.
- For geological models, numeric models and combined models, expand the model in the **Layout Tree** to change how each output volume is displayed. You can also hide some of the output volumes.
- For flow models and block models, you can hide categories or filter the values used to display the model.

If a geological model with an active fault system is added to the section layout, it will include a **Fault System** that contains all the active faults in the model. Click on the **Fault System** to control whether or not it is **Visible** and to set its **Opacity**:

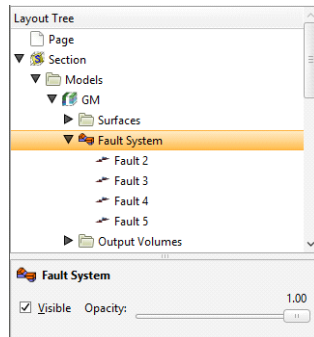

Click on the individual faults to control how they are displayed:

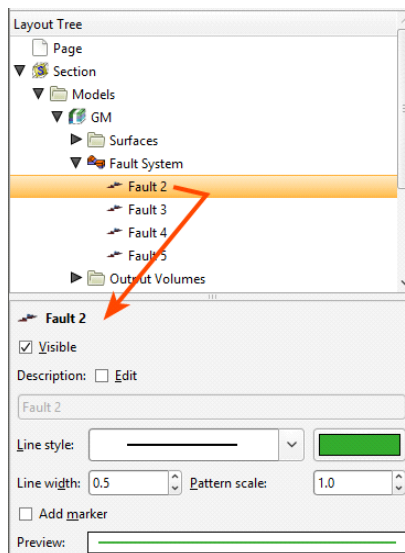

Edit the fault's **Description** by enabling the **Edit** box and then changing the text. You can also change how the fault is displayed, including the **Line style**, **Line width**, **Pattern scale** and colour. You can also define a marker to display along the line by enabling **Add marker** and then specifying a **Symbol** to use. A **Preview** is displayed and the fault will be updated in the section preview:

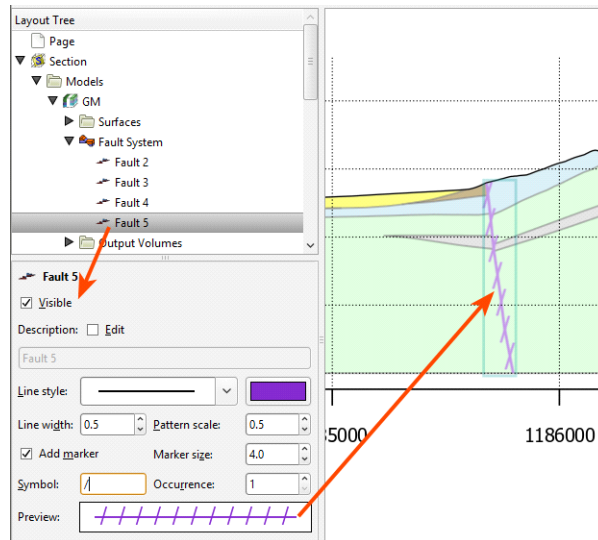

For the volumes in the **Output Volumes** folder, line, border and swatch properties by clicking on the volume in the **Layout Tree** and then changing their properties. Swatches for output volumes can be displayed using a hatched fill. To do this, click on the volume, enable the **Hatch** option and click on the sample to view the available patterns:

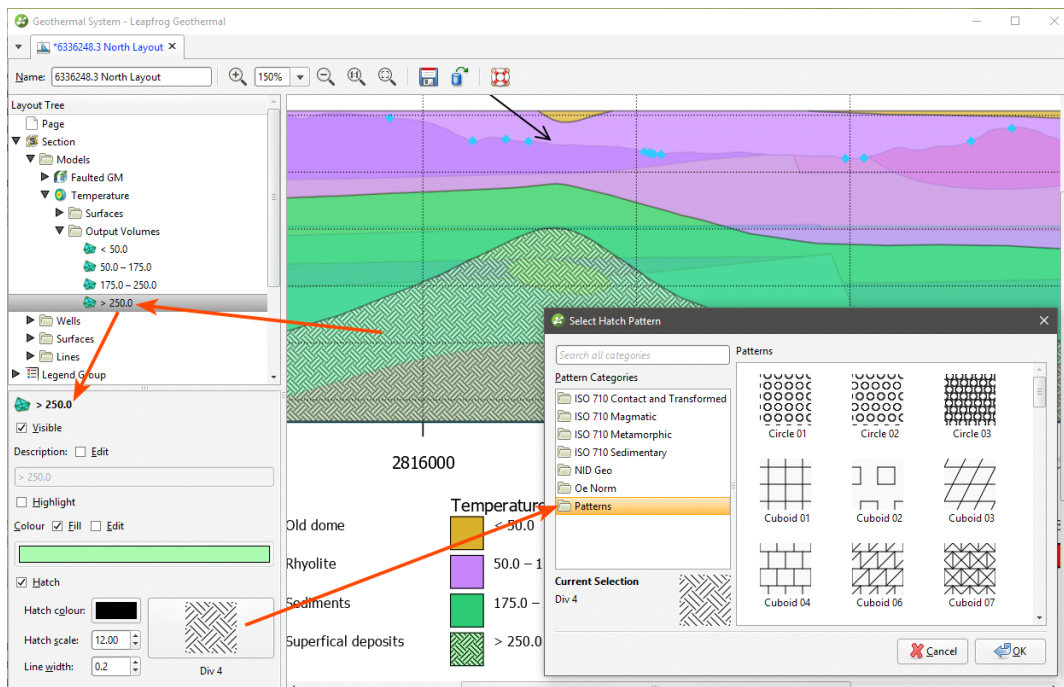

A single line style is used to display a model's output volumes. There is, however, a **Highlight** option that can be enabled to make a volume of interest stand out from the other volumes:

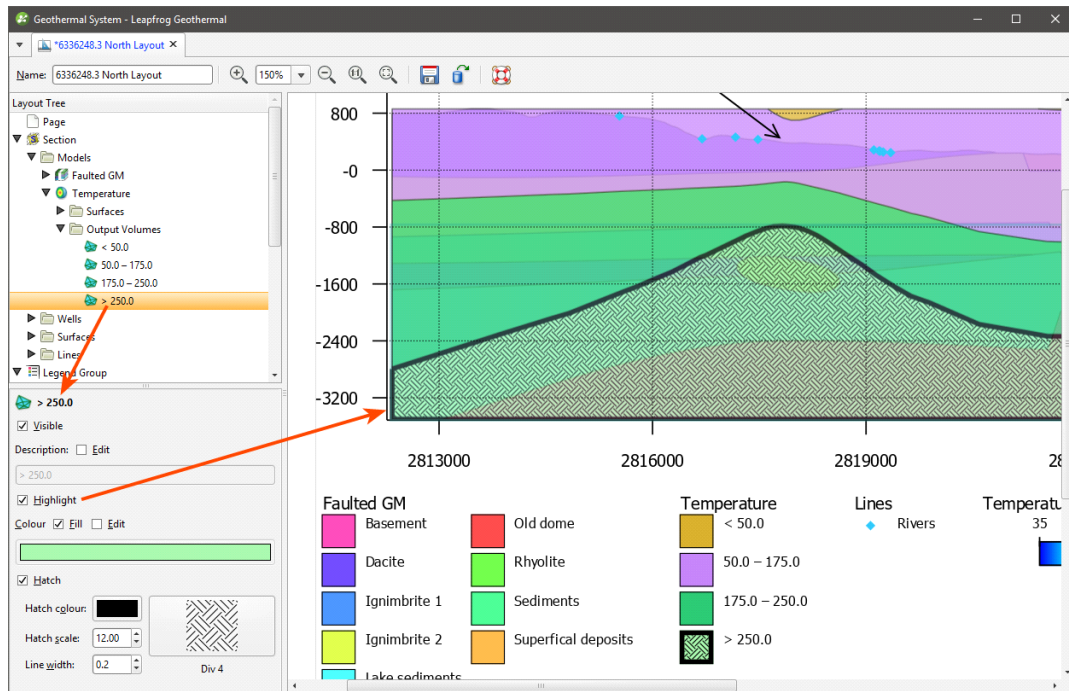

Another way to emphasise a particular volume is to use the surfaces in the model's **Surfaces** folder. This folder contains a single surface for every contact with the section, rather than a single surface for each contact surface in the model:

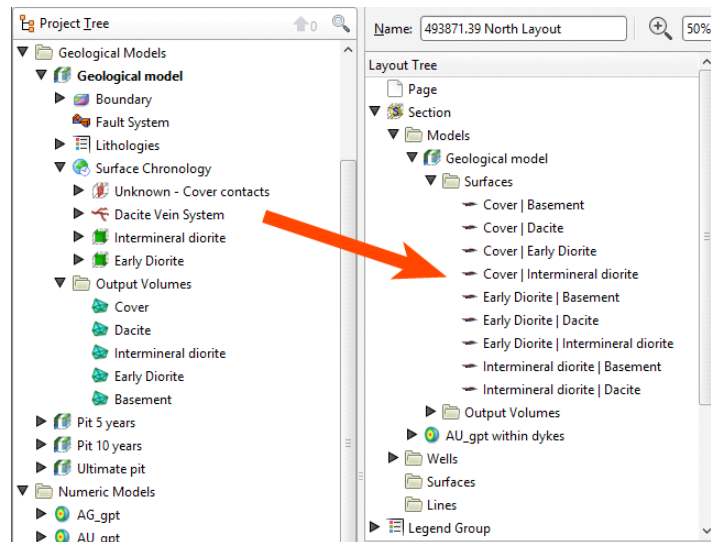

It can result in a large number of surfaces to work with, but does provide you more control over how these surfaces appear on the section layout. For example, here the outline of the GnD volume can be shown in different styles (as with the D2 contact) or not at all (as with the Dike contacts):

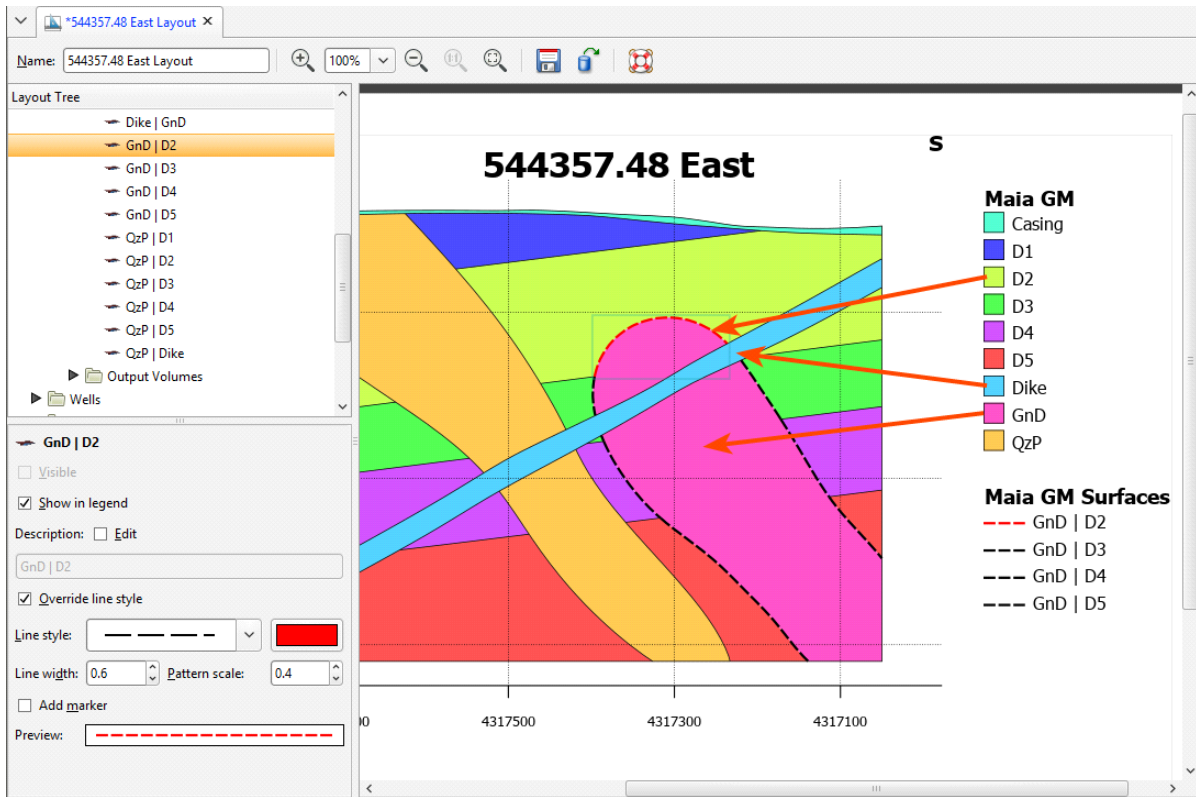

You can display a contact surface on a section layout as a surface evaluation, but you can have only one line style and you don't have control over what parts of the surface are displayed. For example, you cannot hide the surface where it is intersected by the dike:

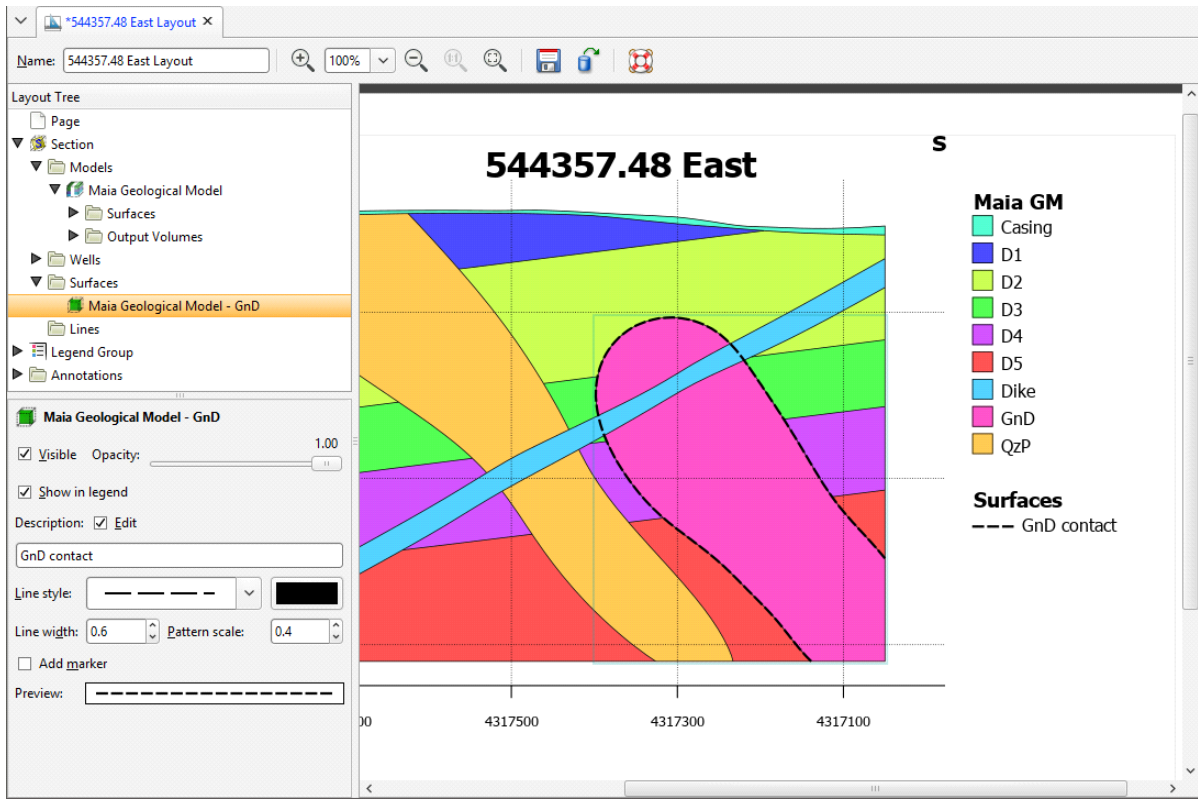

Flow models and block models appear in the **Models** folder as a single object. They can be displayed using a flat colour or any of the **Colouring** options available for the model:

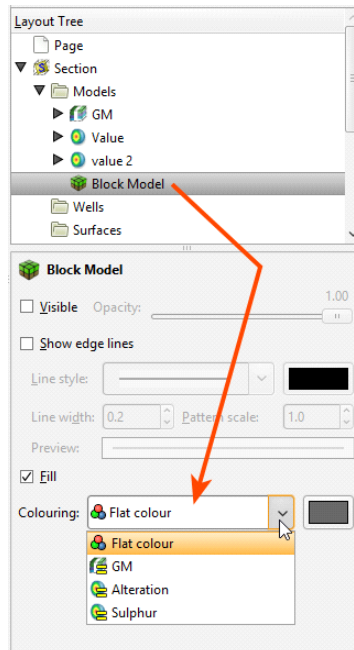

Click **Options** to change the colours used to display the model:

- For category evaluations, you can change what categories are visible and the colours used to display them.
- For numeric evaluations, you can filter values and use a different colourmap.

For example, here, a MODFLOW model is displayed using the **Colouring** from an evaluated geological model:

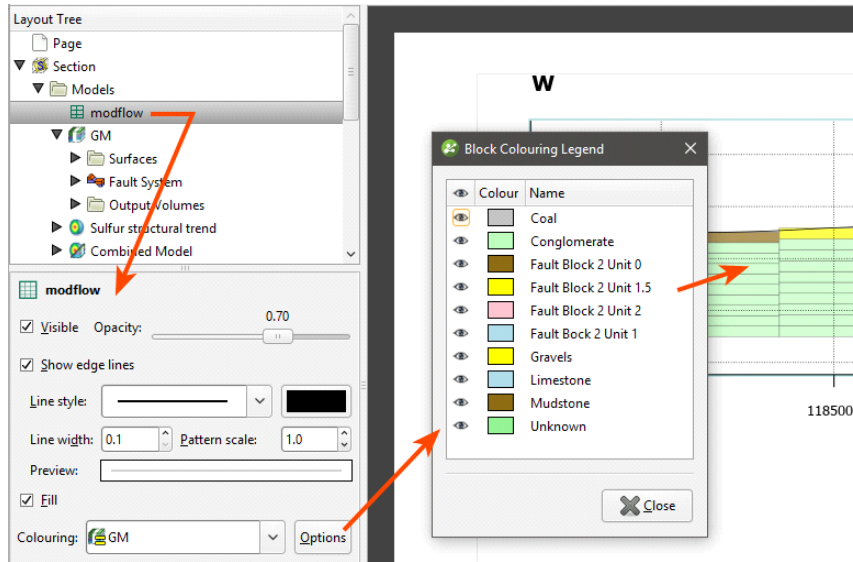

The colours used to display categories cannot be changed in the **Block Colouring Legend** as they are the colours used by the evaluated model itself. You can, however, hide some categories so they are not displayed on the section layout.

Here, the MODFLOW model is displayed using the **Colouring** from an evaluated numeric model:

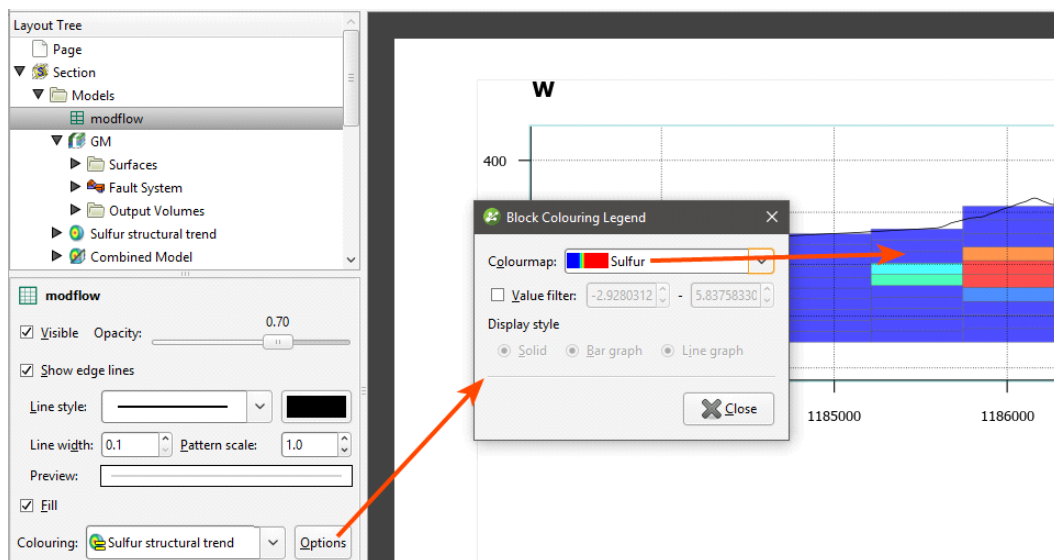

You can change the **Colourmap** used to display the model on the section and you can filter the values displayed.

If a block model or flow model is too big for the section layout, changing the section extents or the section layout extents will effectively “crop” the model and make it small enough to display on the section layout. There are two ways to do this:

- Change the section layout extents by clicking on **Section** in the **Layout Tree**, then clicking on the **Extents** tab. If **Extents** is set to **Evaluation Extents**, change it to **Section Extents**.
- Change the size of the section by double-clicking on it in the project tree and then editing its dimensions in the scene.

Adding Styling Wells and Planned Wells

The **Wells** folder contains all wells and planned wells that have been added to the section layout. Up to three columns of data can be displayed, and numeric data can be displayed as a graph.

To add wells to the section, right-click on the **Wells** object and select either **Add Wells** or **Add Planned Wells**.

For adding wells, you will be prompted to select the interval table to display.

For both wells and planned wells, you can filter the wells based on a minimum distance from the section plane:

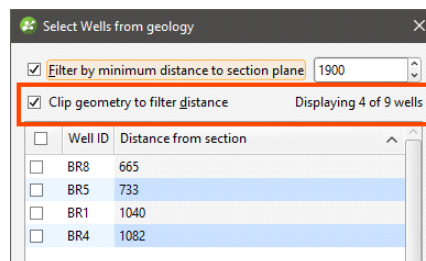

This is the minimum distance to any point on each well trace.

If you tick the **Clip geometry to filter distance** option, only parts of the well within the **filter distance** will be included in the section layout. Select the required wells and click **OK**.

When wells and planned wells are added to a curved section, a projection is made based on the locations of neighbouring segments of the section, using the bisectors of the angles between each segment and its neighbour. These determine the projection point of origin for a given segment of the section. When wells are filtered by the distance to the section plane, the distance is measured at 90 degrees from the section. Some wells may report a distance that is greater than the specified minimum distance; if this is the case, it is because the evaluation distance is relative to the projection origin.

On the inside of a tight corner, a single well may be projected multiple times onto the section. If this is the case, the multiple instances of the well will appear in the boreholes list and you can turn individual instances off, if required.

When a fence section is updated, well evaluations are updated. If there are multiple instances of a well evaluation, how they appear on the section may change when the section is updated:

- If all instances of a well evaluation have been enabled, then all remain enabled when the section is updated.
- If all instances of a well evaluation have been disabled, then all will remain disabled when the section is updated.
- If only some instances of a well evaluation have been enabled, then all instances will be enabled when the section is updated.

When a section layout is copied to another section from a fence section, well evaluations will not be copied with the section layout.

To hide or change the appearance of well labels, click on the well table, then on the **Points and labels** tab. Click **Options** to change how the labels are displayed. You can rotate labels and have a line connecting the label to the collar:

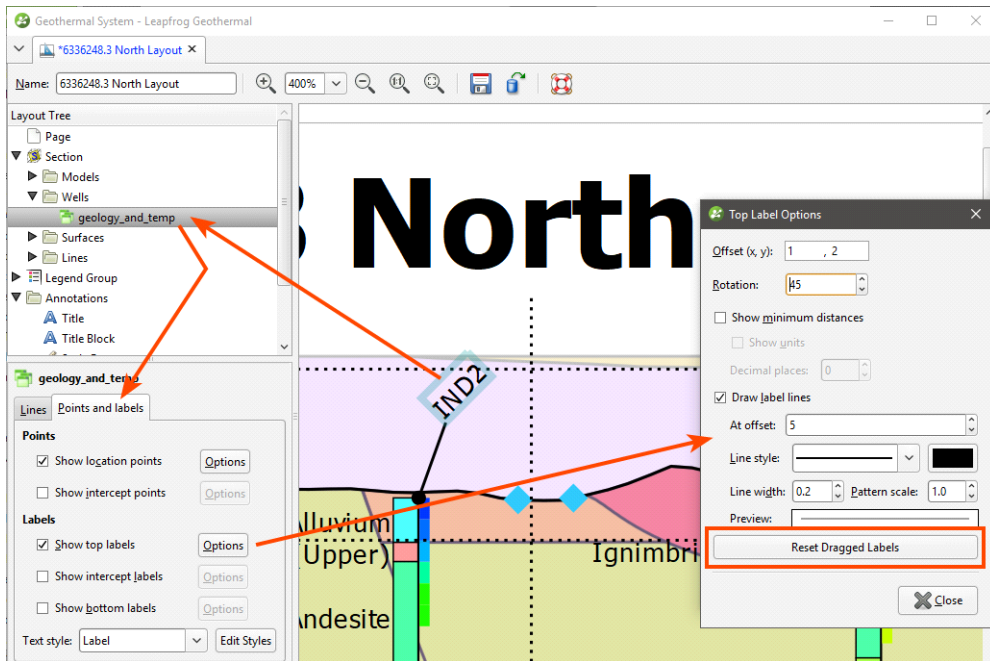

You can also click on the labels in the layout and move them. Note that the label lines will only appear once the well label has been moved away from the collar.

If you want to return all labels to their default positions, click **Reset Dragged Labels** in the **Points and Labels > Label Options** window.

How wells are displayed is controlled by the **Colourings** settings in the **Lines** tab:

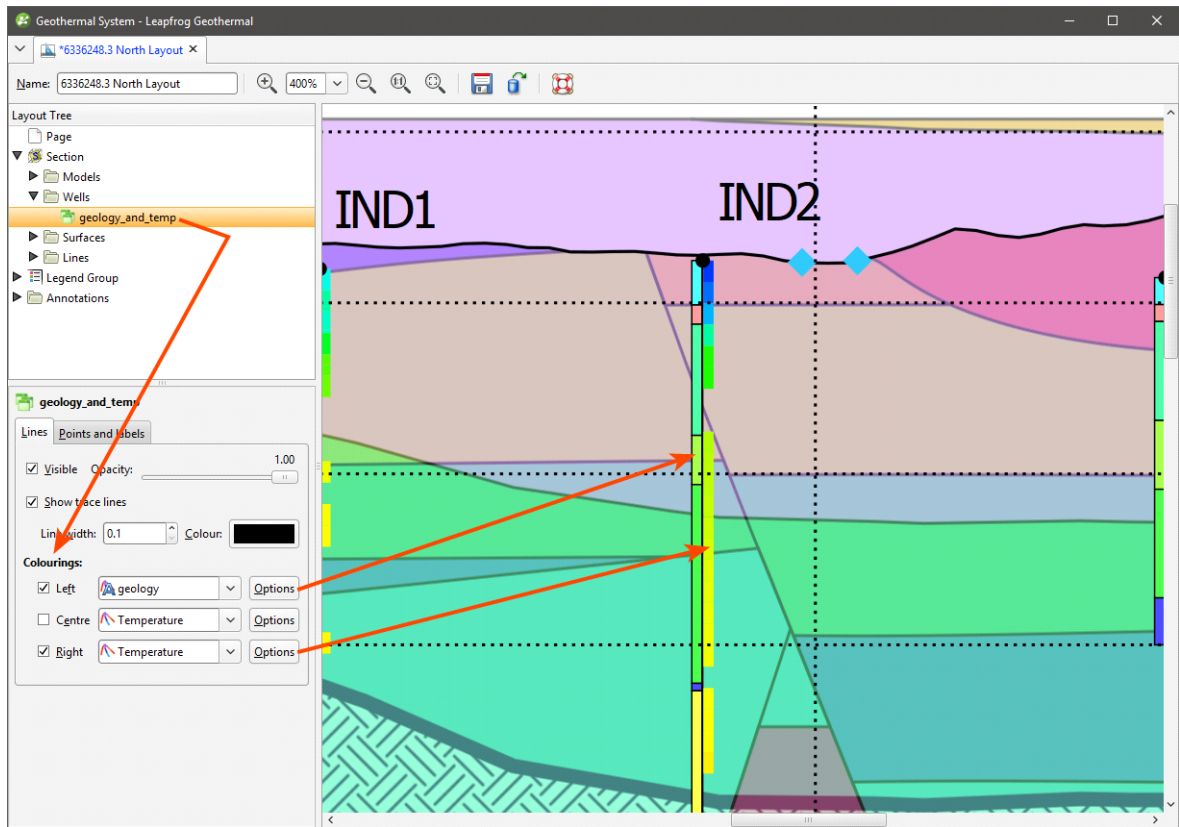

Click the **Options** button to display data (category data) or filter values (numeric data) on the wells:

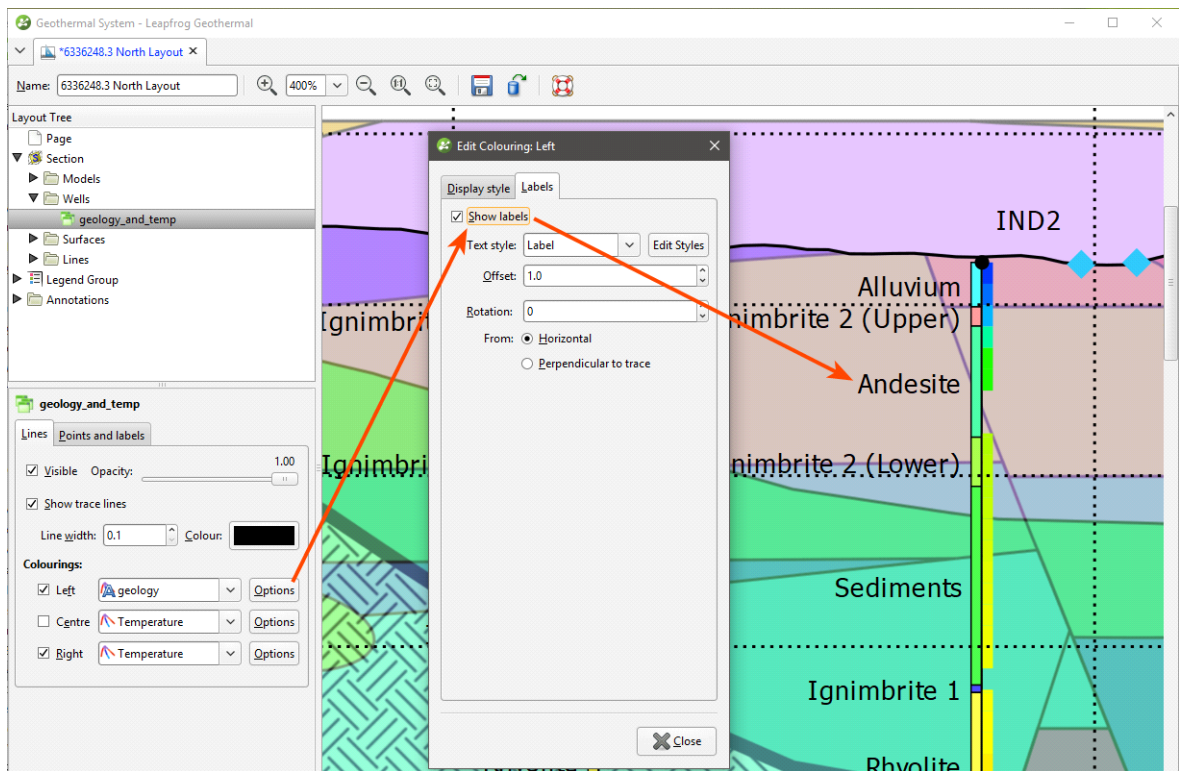

Wells can be displayed using hatching patterns. In the **Display style** tab, tick the **Hatched** option, then select from the patterns available:

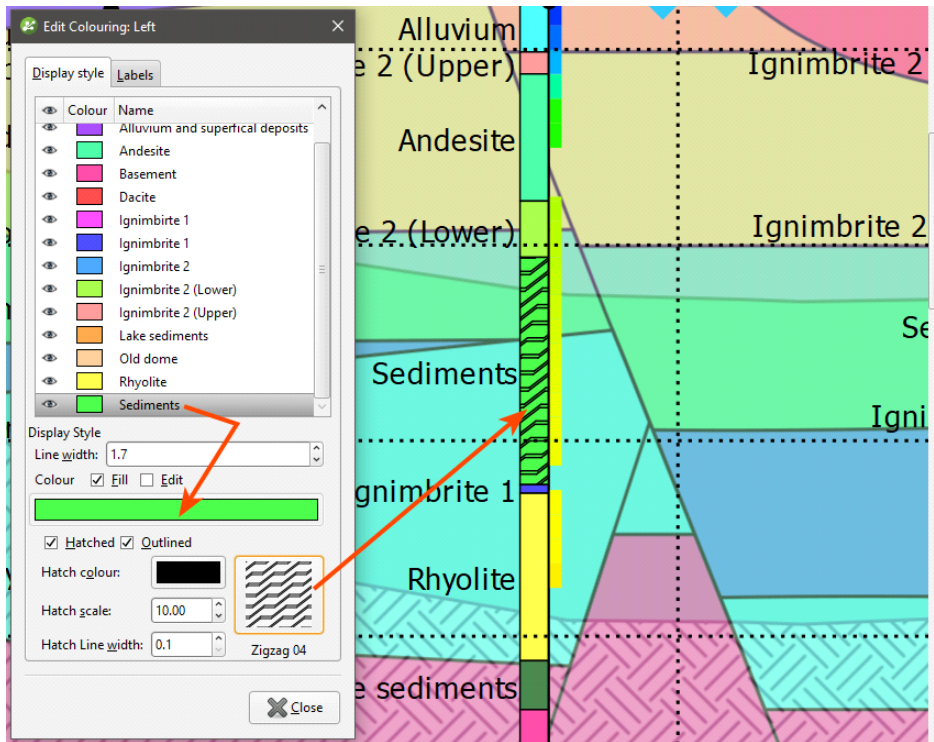

For columns of numeric data, you can display data as a bar graph or line graph. These options are available in the **Display style** tab. Here, data is displayed as a bar graph:

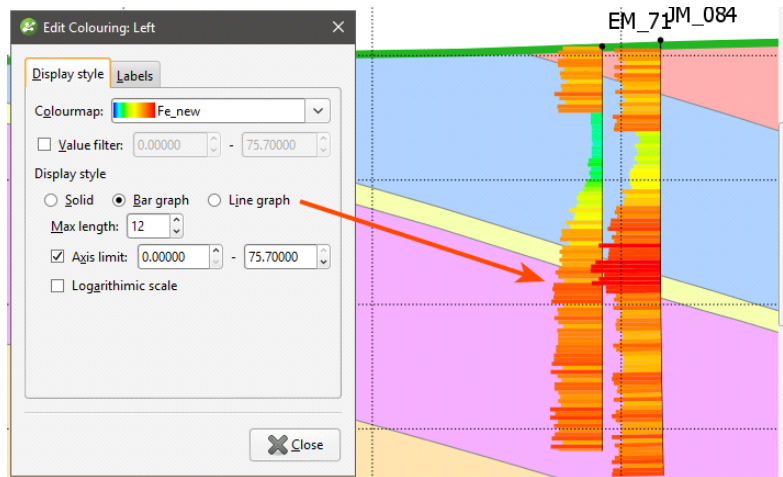

Select a **Max length** that means that displayed data does not interfere with other wells or data displayed on the section layout. This is especially useful when two graphs are displayed:

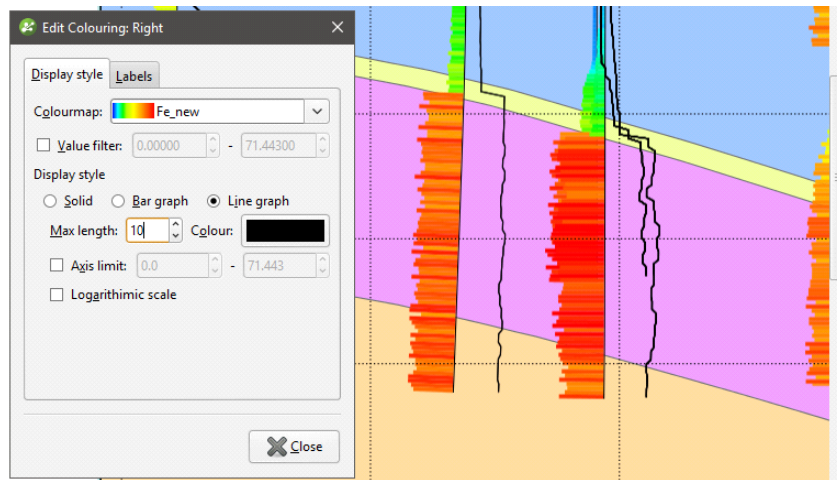

If you only want to plot a limited range of data, tick the **Axis limit** box and set the required range.

Displaying data with the logarithmic scale enabled may enhance differences in the values, and negative values can be scaled.

The bar and line graph options are not available for the centre of the well, although the solid option can be used.

Adding and Styling Surfaces

The **Surfaces** folder contains all surfaces that have been added to the section layout. To add another surface, first make sure it has been evaluated on the section, then right-click on the **Surfaces** folder and select **Add Surface**. Select from those available and click **OK**.

Click on the surface in the **Layout Tree** to view styling options:

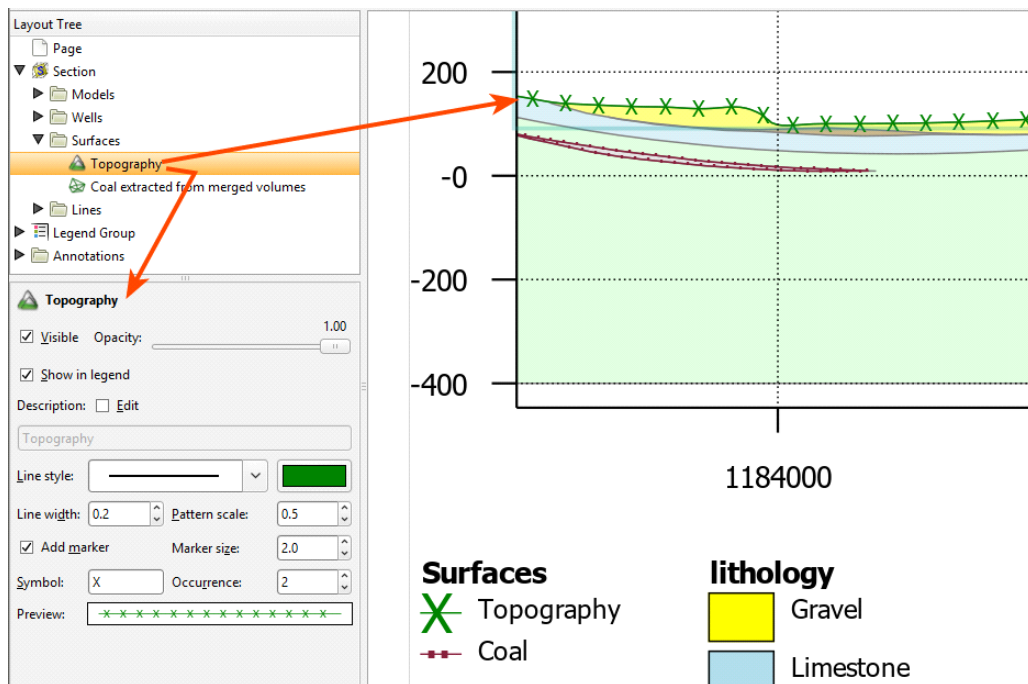

Edit the text used to display the surface by enabling the **Edit** box and then changing the text. You can change the **Line style**, **Line width**, **Pattern scale** and colour. You can also define a marker to display along the line by enabling **Add marker** and then specifying a **Symbol** to use. A **Preview** is displayed and the surface will be updated in the section preview.

You can see below how changes to the **Line style**, **Symbol** and **Occurrence** can be used to indicate different conditions:

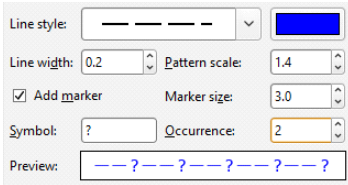

- Line style: Long dash
- Symbol: ?
- Occurrence: 2

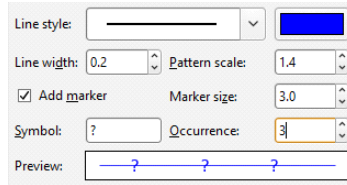

- Line style: Solid line
- Symbol: ?
- Occurrence: 3

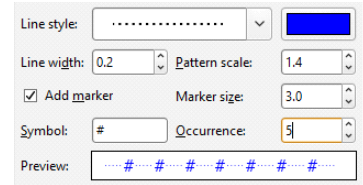

- Line style: Dotted
- Symbol: #
- Occurrence: 5

Adding and Styling Lines

The **Lines** folder contains all lines that have been added to the section layout. To add another line, first make sure it has been evaluated on the section, then right-click on the **Lines** folder and select **Add Line**. Select from those available and click **OK**.

Click on the line in the **Layout Tree** to view styling options, including the size, shape and colour of the pierce point:

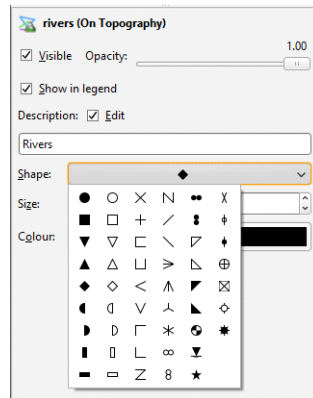

Setting Up the Legend

The **Legend Group** and the individual legends underneath it control how the legend is displayed on the page.

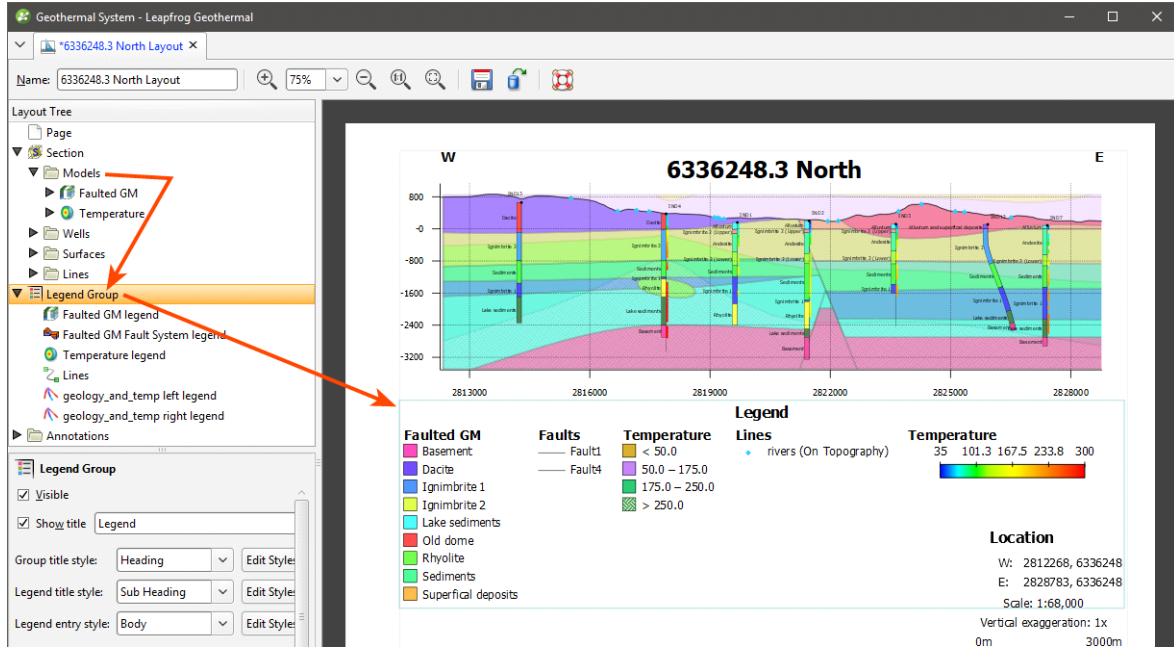

Click on the **Legend Group** object to change the layout of the legend as a whole:

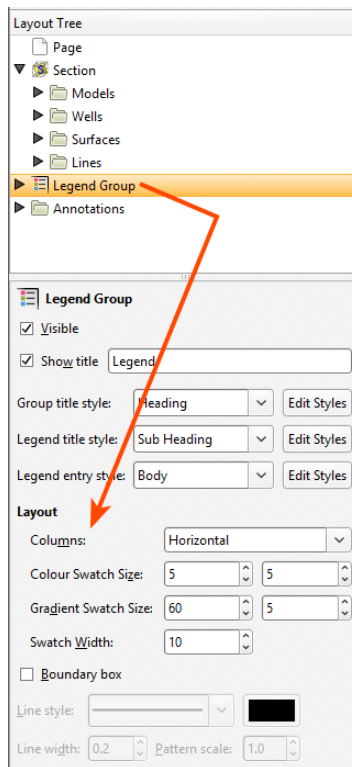

Columns can be laid out vertically or horizontally, and you can also change the swatch size and gradient and add a **Boundary box**. For individual legends that have a large number of entries,

you may need to increase the number of rows. For example, for the combined model, the number of rows has been increased to accommodate the number of entries in the legend:

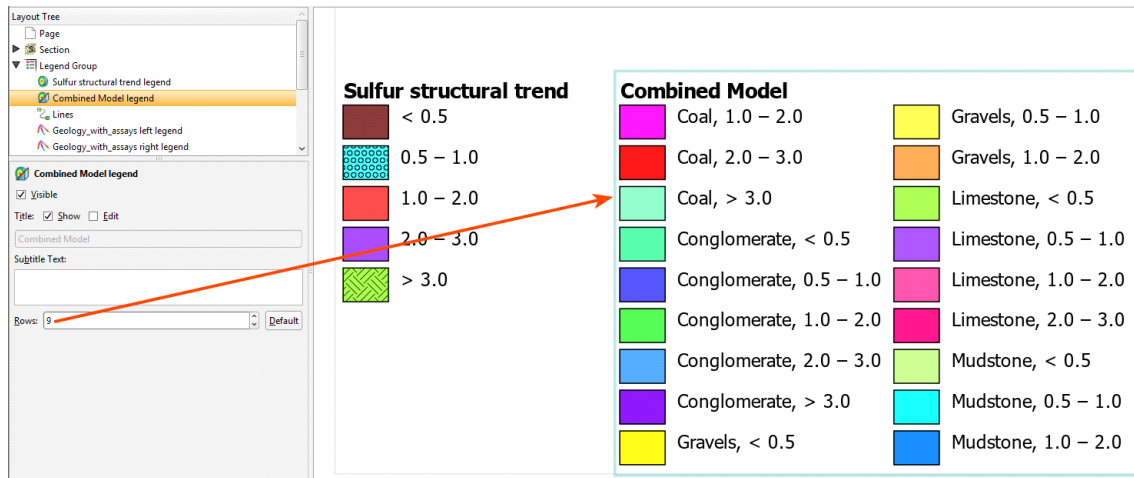

When you have multiple models, surfaces, lines and wells on the section layout, you can end up with a large number of entries in the **Legend Group**. How you hide a legend in the **Legend Group** depends on the type of object. Objects displayed on the section layout appear in the **Legend Group** as follows:

- Each model on the layout has an individual entry. Hide a model in the **Legend Group** by clicking on the model's entry and disabling the **Visible** option.

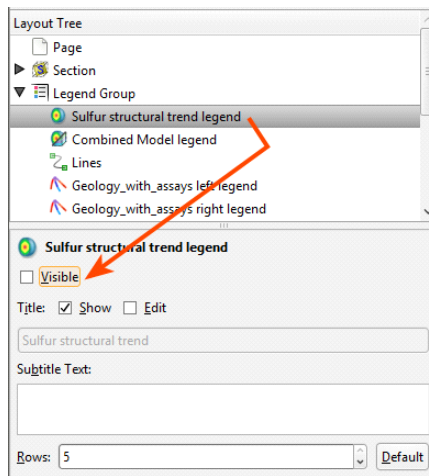

- Each geological model, numeric model and combined model has a **Surfaces** folder, which will have its own entry in the **Legend Group** when at least one surface in that folder has been set to **Show in legend**. The surfaces legend for a model itself can be hidden in the **Legend Group** by clicking on the entry and disabling the **Visible** option:

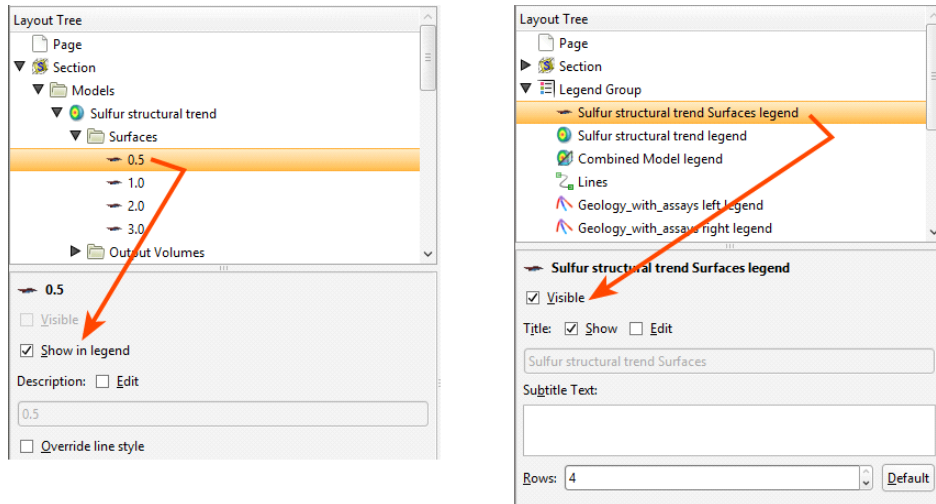

- Each well column that appears on the section has an individual entry. Hide a column in the **Legend Group** by clicking on the column's entry and disabling the **Visible** option:

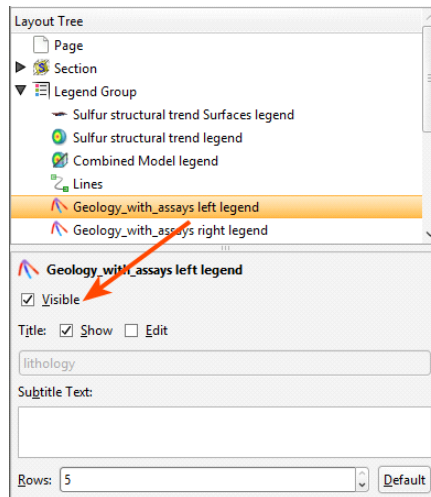

- Planned wells that appear on the page do not appear in the **Legend Group**.
- Surfaces in the **Section > Surfaces** folder appear in the **Legend Group** as a single entry. Hide a surface in the **Legend Group** by clicking on the surface in the **Surfaces** folder and disabling the **Show in legend** option:

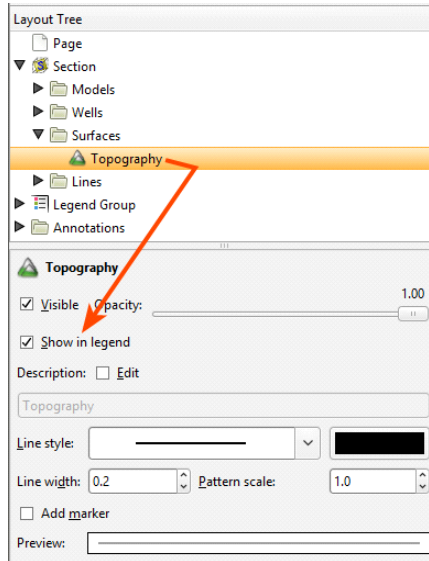

- Lines in the **Section > Lines** folder appear in the **Legend Group** as a single entry. Hide a line in the **Legend Group** by clicking on the line in the **Lines** folder and disabling the **Show in legend** option:

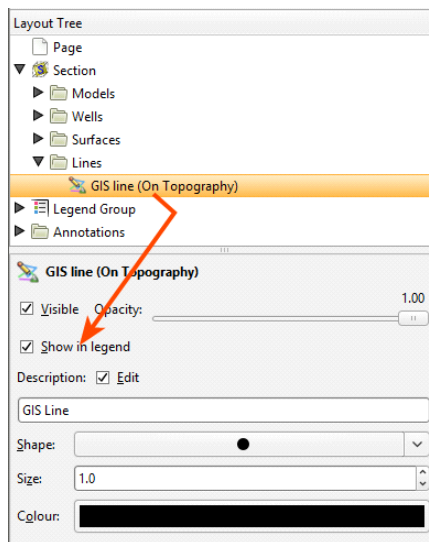

The order in which legends appear in the **Legend Group** is the order in which they appear in the **Layout Tree**. To change the order in which the legends appear, right-click on them and select a **Move** option.

The colours, line widths, fills and hatches displayed in the **Legend Group** are controlled by the objects themselves. For example, to change how a shell is displayed for the interpolant, click on the output volume, under the **Models** object:

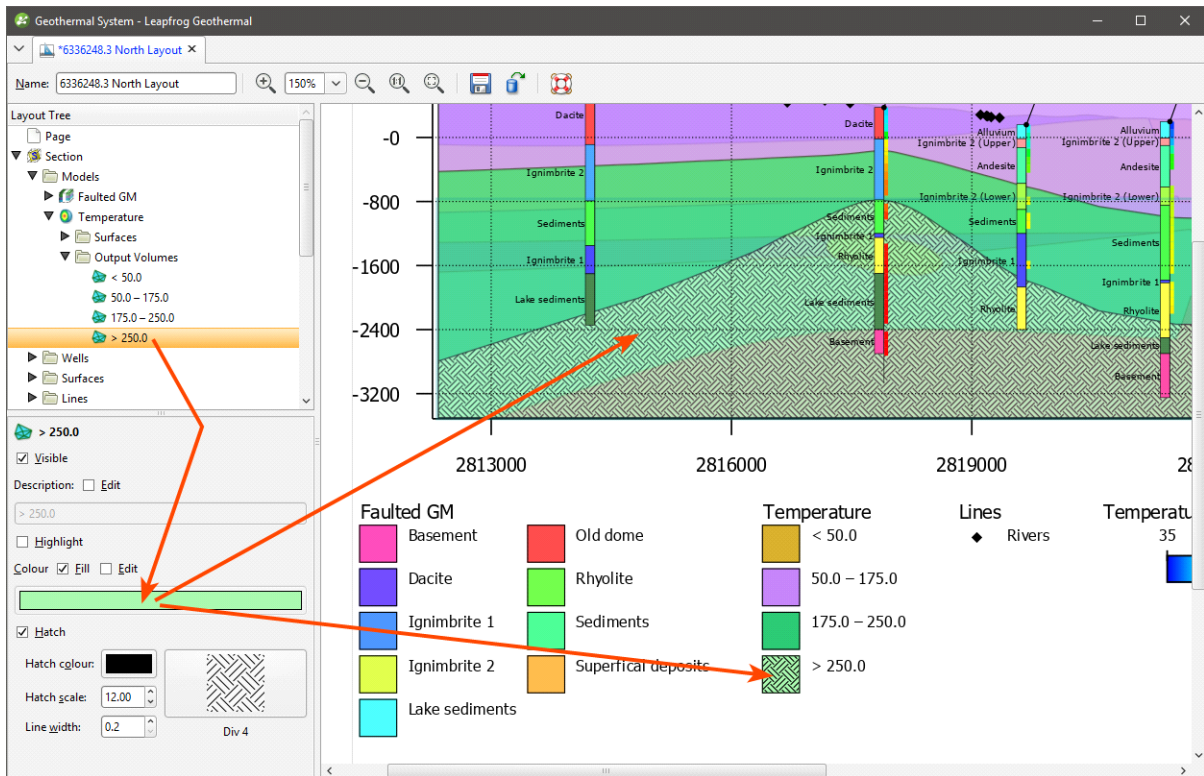

Adding and Organising Annotations

Once you have laid out the main **Section** object and organised the **Legend Group**, you can add a number of different types of annotation to the layout, including a title, a title block, location information and a scale bar, text boxes and imported images.

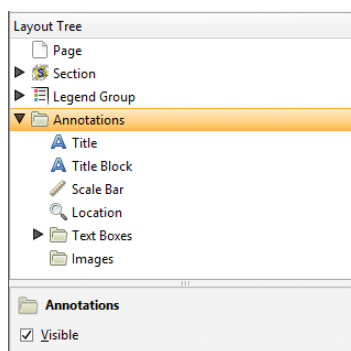

Displaying a Title

The **Title** object formats the title displayed on the page. To move the title, click on it in the layout preview. The text used for the **Title** is the name for the section in the project tree, but this can be changed in the properties panel. Enable the **Edit** option, then edit the text in the box:

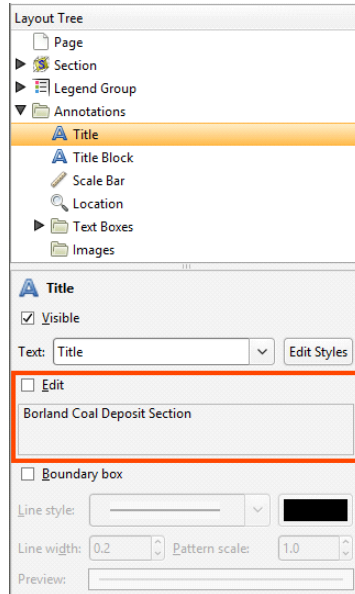

You can display a line around the **Title** by enabling the **Boundary box** option. You can customise the **Line style**, **Line width**, **Pattern scale** and colour of the box. A **Preview** is displayed and the boundary is updated in the section preview.

Displaying a Title Block

When the **Title Block** is visible, a title block based on ISO 7200 is displayed on the layout:

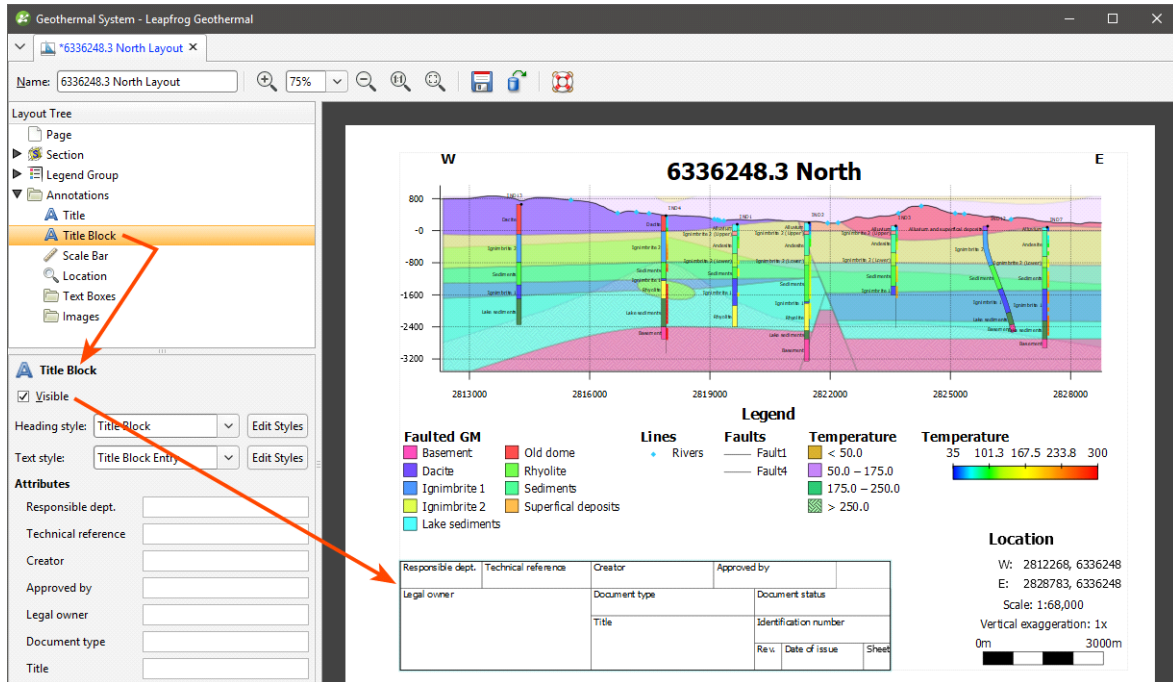

To display the **Title Block** on the section, select it in the **Layout Tree**, then tick the **Visible** box. In this panel, you can also change the styles used to display the information in the block.

Displaying a Scale Bar and Location Information

There are a number of different styles available for the **Scale Bar**, and you can control its **Length**, **Partitions** and **Thickness**:

The screenshot displays a software interface with a layout tree on the left, a main map area, and a scale bar and location information panel on the right. The layout tree includes 'Page', 'Section', 'Legend Group', 'Annotations', 'Title', 'Title Block', 'Scale Bar', 'Location', 'Text Boxes', and 'Images'. The 'Scale Bar' panel is active, showing settings for 'Visible', 'Length' (1500), 'Partitions' (4), 'Bar style', 'Line width', 'Thickness' (5.0), 'Colour', 'Scale Bar Labels', 'Show Labels', 'Show Units', 'End Points Only', 'Text Style' (Scale Labels), 'Text' (Show scale, Show vertical exaggeration), 'Boundary box', 'Line style', 'Line width' (0.2), and 'Pattern scale' (1.0). The main map area shows a scale bar with a length of 1500m, divided into 4 partitions, and a location information panel. The location information panel displays 'Location', 'W: 1183245, 4907382', 'E: 1189060, 4907382', 'Scale: 1:24,000', 'Vertical exaggeration: 1.5x', and a scale bar from 0m to 1500m. An orange arrow points from the 'Line width' setting in the 'Scale Bar' panel to the scale bar in the location information panel.

You can show the **Scale Bar** with or without labels, and labels can be shown all along the bar by disabling the **End Points Only** option:

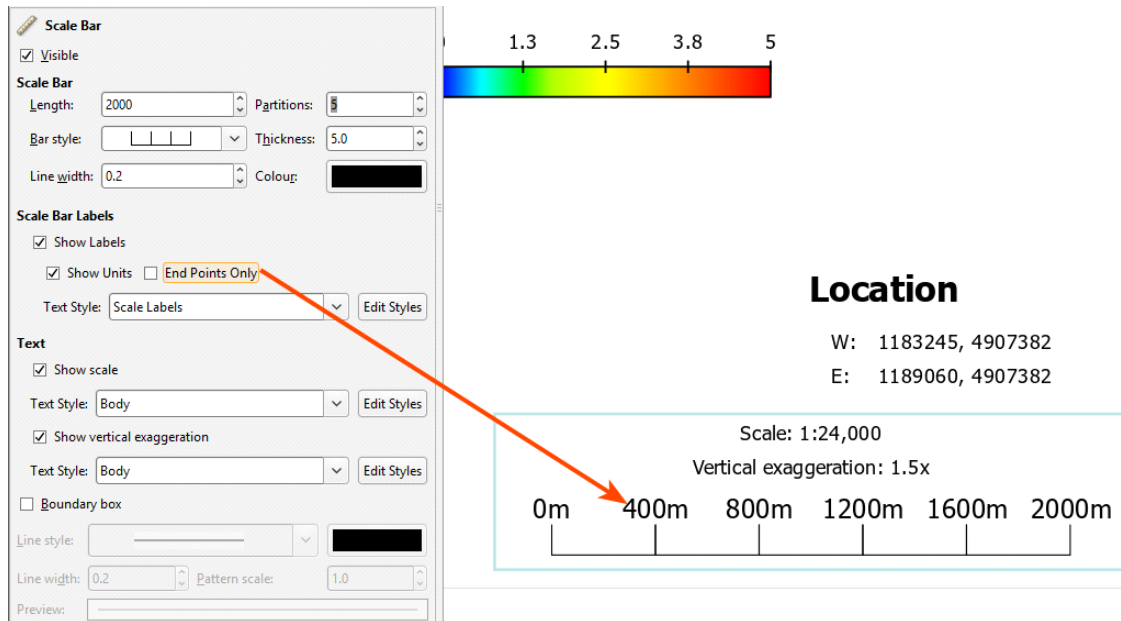

The **Text** options determine whether or not the scale and vertical exaggeration are shown on the scale bar.

The **Location** object controls how location information is displayed:

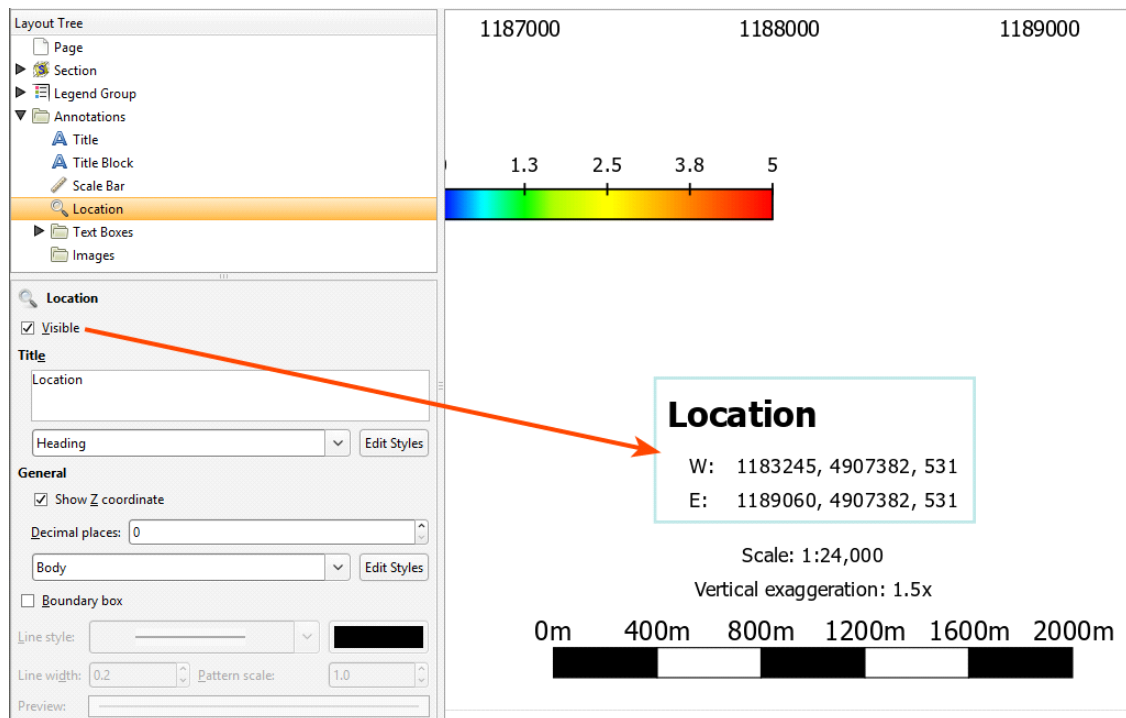

You can include the Z coordinate, if required and change the number of decimal places used to display coordinates.

There is a **Boundary box** option for both the **Scale Bar** and the **Location**. You can customise the **Line style**, **Line width**, **Pattern scale** and colour of the box. A **Preview** is displayed and the boundary is updated in the section preview.

Text Boxes

With the **Text Boxes** object, you can add text boxes and arrows to highlight information and details on the section:

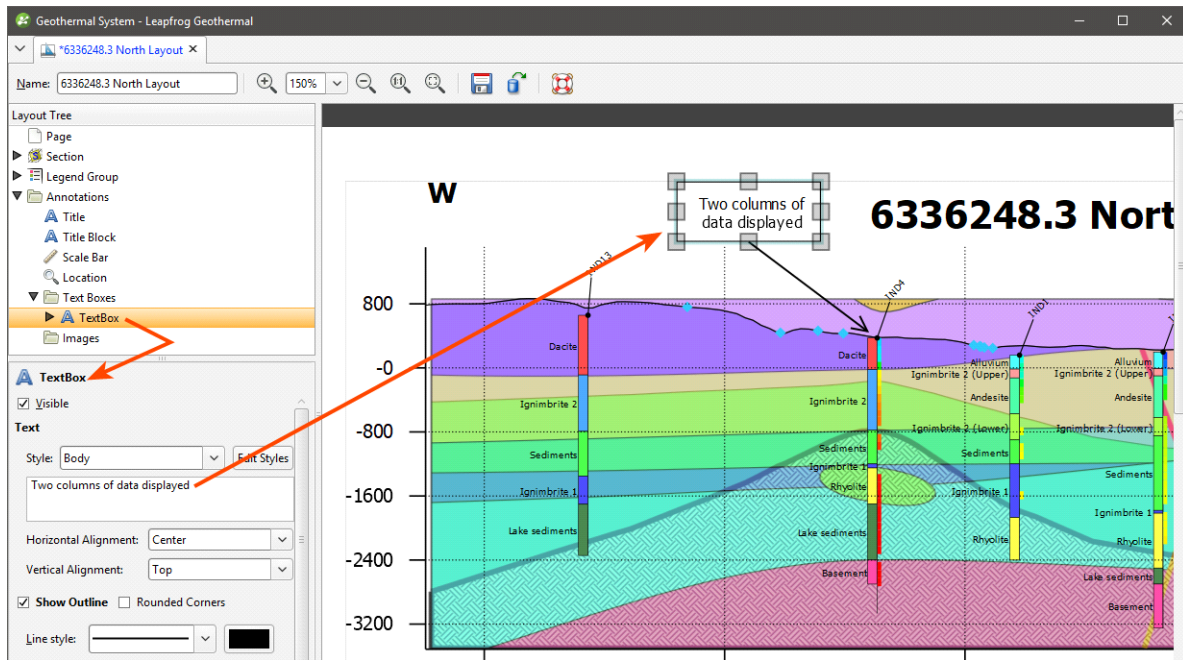

There is a **Show Outline** option for the text box, and corners can be square or rounded. You can customise the **Line style**, **Line width**, **Pattern scale** and colour of the outline. A **Preview** is displayed and the text box is updated in the section preview.

Arrows are connected to text boxes, and so initially only text boxes can be added. Right-click on a text box to add an arrow to it. When the **Automatic anchoring** option is enabled for an arrow, the arrow's anchor will move when its associated text box is moved:

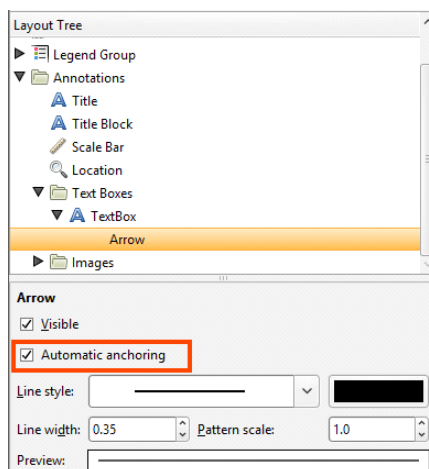

If this option is disabled, the arrow will move when you move the text box, but you will have to place its anchor manually.

Images

If you wish to import an image such as a logo or map, right-click on the **Images** object and select **Add Image**. Navigate to the folder that contains the image file and select the file. Click **Open** to import the file, which will automatically be added to the section layout:

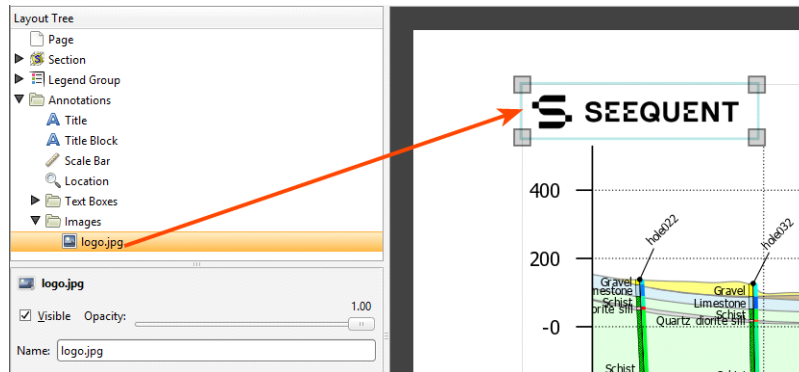

Move the image by clicking on it in the preview and dragging it. You can resize the image using the controls in the preview.

Rendered Images

Leapfrog Geothermal can render high-quality images that you can save on your computer in a format that can be used in presentations and documents. To do this, click on the **Render Image** button in the toolbar (🖨️) or click on the **Leapfrog Geothermal** menu and select **Render Image**. Leapfrog Geothermal renders an image from the current scene window, then displays it in the **Render Image** window:

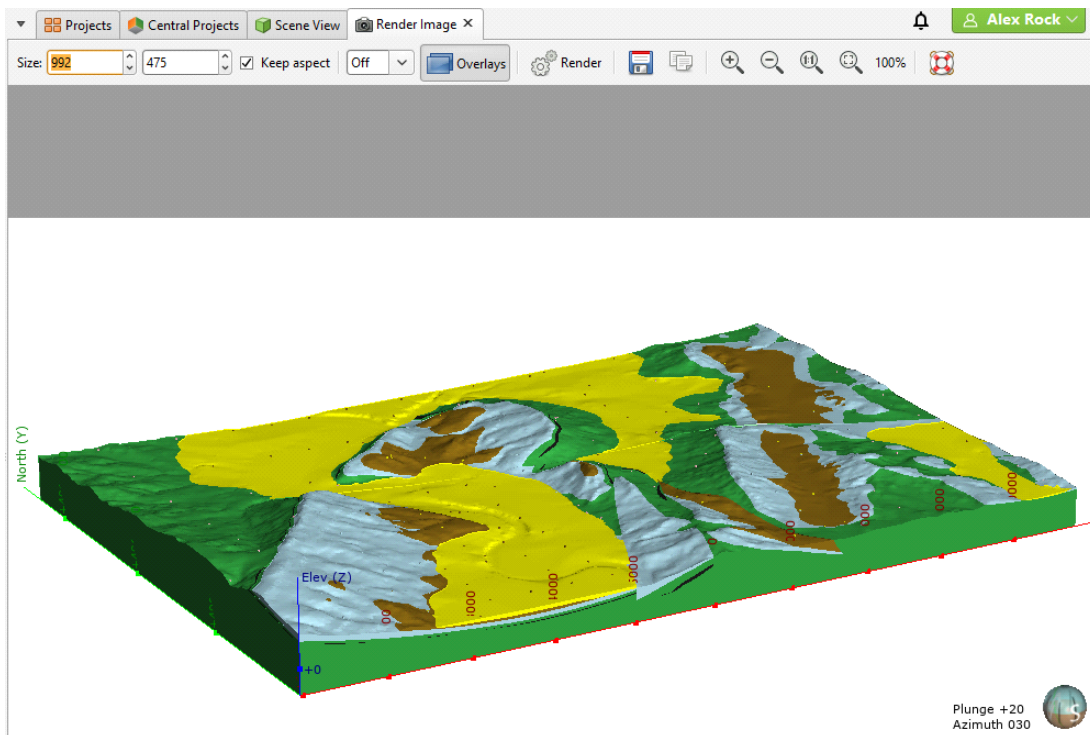

If you are displaying multiple views in the scene, you can select which ones you want to render from the **Render View** list:

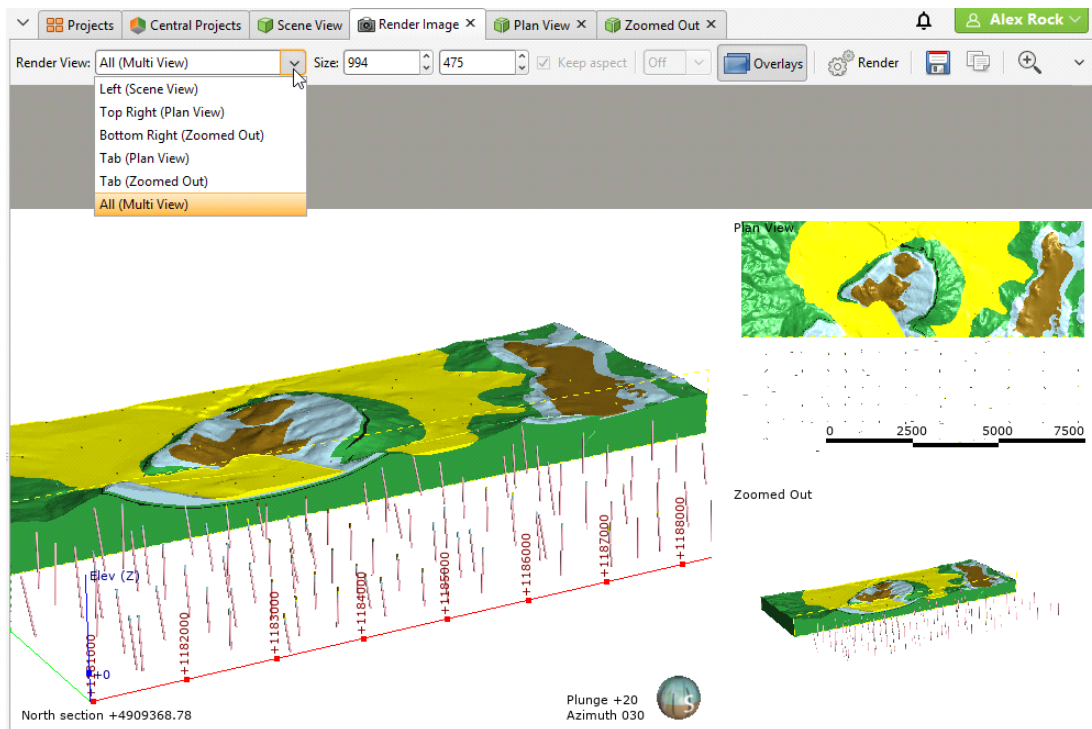

Views that are open in tabs are also listed in the **Render View** list. However, the **All (Multi View)** option only renders the split of views displayed in the **Scene View** tab.

Use the zoom tools to view the rendered image. You can change the image settings by:

- Selecting a new image size. To constrain the image’s proportions when changing size, tick the **Keep aspect** box.
- Changing supersampling options to smooth jagged edges. Select the required option from the list. The highest sampling option (**4x4**) will take longer to process than the lowest sampling option or turning supersampling off.
- Viewing the image with or without overlays. See [Overlay Settings](#) for more information about further customising the overlays displayed in the scene.

Click the **Render** button to update the image with the changed settings. Once you are satisfied with the rendered image, click **Save**. You will be prompted to enter a filename and location.

Background Rendering

You can keep the **Render Image** tab open while continuing to work in your project, which is useful for rendering a series of images. To work in this way, dock the **Render Image** tab adjacent to the scene window. When you have set up your scene, right-click on the **Render Image** tab and choose one of the options:

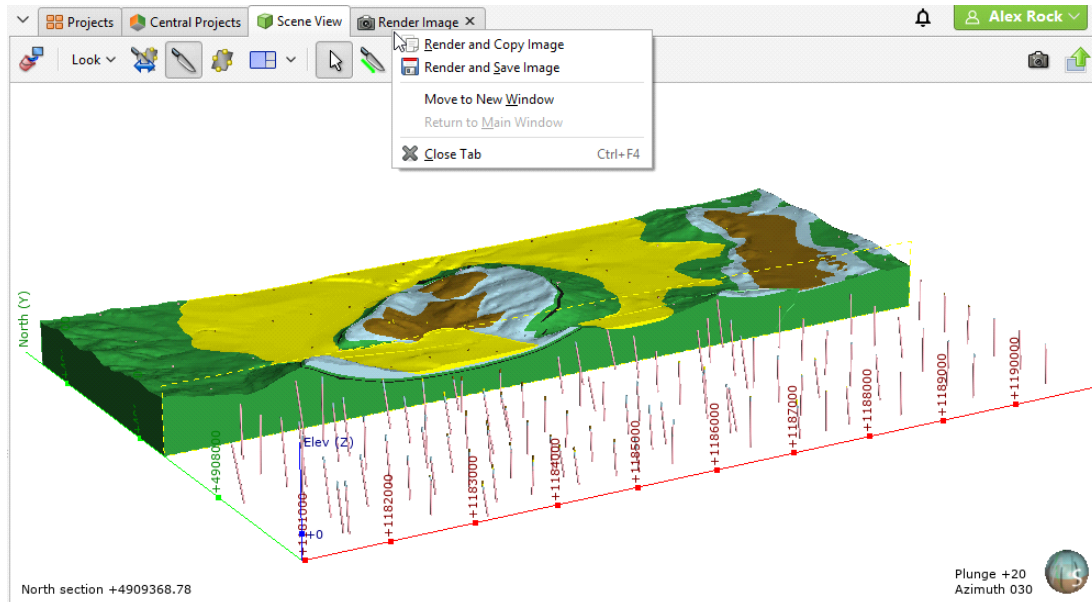

The **Render and Copy Image** option will render a new image from the scene and copy it to the clipboard.

The **Render and Save Image** option will render a new image and prompt you for a filename and location.

Saved Scenes

A saved scene is a way of storing the shape list and settings so that the scene can be retrieved later. Saved scenes are the basis of scene files exported to Leapfrog Viewer and Leapfrog Aspect. Saved scenes are also used in creating movies, which is described in the [Movies](#) topic.

This topic describes:

- [Saving Scenes](#)
- [Exporting Scenes](#)
- [Exporting Scenes for Leapfrog Aspect](#)
- [Linking to Scene Files](#)

A saved scene is, in effect, a bookmark of a specific view of the project data. A saved scene does not maintain an independent copy of the data in the project, and so if the data changes, then the appearance of the scene will also change.

When a scene is saved, comments can be entered documenting what is in the scene. Saved scenes provide a stable point of reference in a project and can explain important aspects of the

project, which is especially useful for explaining aspects of a model to others using the project or viewing scene files.

Saving Scenes

To save the current scene, right-click on the **Saved Scenes and Movies** folder and select **Save Current Scene**. The **Save Scene** window will be displayed:

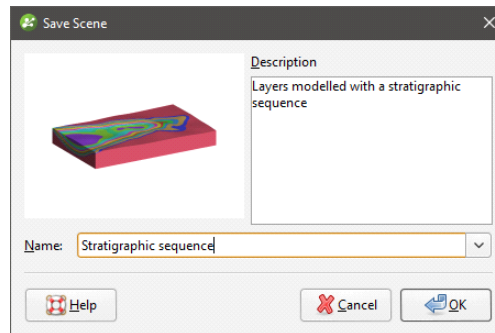

Enter a name and description for the scene and click **OK**. The scene will be saved and added to the **Saved Scenes and Movies** folder.

When you save a scene, the properties settings in the shape list are saved for the objects displayed in the scene. For example, if a lithology table is displayed with the legend in the scene, the legend will be displayed when the scene is restored. However, saved scenes do not store copies of the objects in the project tree, and objects deleted from the project tree are no longer available in saved scenes.

To edit a scene, double-click on it. The **Edit Saved Scene** window will be displayed and you can update the information.

To display a scene, drag it into the scene.

Exporting Scenes

Once you have a series of saved scenes, you can use them to create a scene file that can be opened in Leapfrog Viewer or Leapfrog Aspect. See [Exporting Scenes for Leapfrog Aspect](#) for points to consider when creating scene files that will be opened in Leapfrog Aspect.

To export a scene, right-click on the **Saved Scenes and Movies** folder and select **Export Scenes**. The **Export Scenes** window will be displayed:

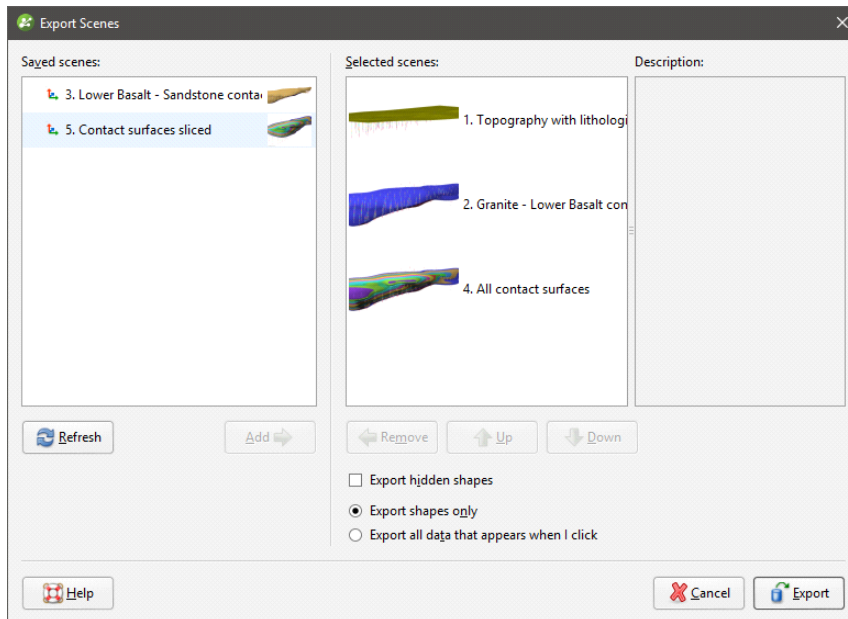

You can also export an individual scene by right-clicking on the scene and selecting **Export**.

Move the scenes you wish to export to the **Selected scenes** list and reorder them, if required.

If you tick the **Export hidden shapes** box, objects in the shape list that are not visible in the scene window will be included in the exported scene.

You can also export the data associated with the objects in the scene window, if required. To do so, select the **Export all data that appears when I click** option. If viewing the data is not required, or if you wish to keep sensitive data secure, select the **Export shapes only** option.

When the **Export all data that appears when I click** option is selected, all data represented by shapes in the exported scene will be accessible when the scene is opened in Leapfrog Viewer.

When you have the scenes arranged, click **Export**. You will be prompted for a filename and location.

Exported scenes cannot be reimported to the project.

Exporting Scenes for Leapfrog Aspect

When exporting scenes for use in Leapfrog Aspect, keep in mind the following:

- When viewing 3D data on a 2D screen, objects may appear closer or further from the viewer than expected. For this reason, it is a good idea to include a current topographic surface in the dataset to aid in orienting the view relative to the camera feed.

- Although newer Android devices have a significant amount of processing power, they are not as graphically capable as a typical desktop computer. Try to limit the amount of data to be displayed as there are likely to be issues if a scene contains 10,000 wells or a million points.
- Scenes with complex wireframes will load more slowly than simple wireframes. It is a good idea to make a simplified copy of a wireframe in Leapfrog Geothermal and use that wireframe to create a scene.
- Both **Export all data that appears when I click** and **Export shapes only** options will work for Leapfrog Aspect. If you wish to display collar IDs, use the **Export all data that appears when I click** option, but keep in mind that displaying hole IDs can be slow and choppy.

Linking to Scene Files

Links to scene files can be included in HTML files using the following format:

```
<a href="LeapfrogViewer:[path or URL]">link text</a>
```

Linked scene files will be opened directly in Leapfrog Viewer only from browsers that support custom URI schemes.

Movies

Once you have a series of saved scenes (see [Saved Scenes](#)), you can use them to create a storyboard and export a movie.

To create a new movie, right-click on the **Saved Scenes and Movies** folder and select **New Movie**. A tab will open in which you can create a storyboard and edit how each scene and transition is displayed. You can detach the tab from the main window and create scenes in the main window while working on scenes in the movie tab. Click the **Refresh Scenes** button to refresh the scenes in the movie tab when you have made changes.

Select the saved scenes you wish to add to the movie by clicking on them in the list, then click the **Add To Storyboard** button (E+). When subsequent scenes are added, transitions will be added to separate the scenes:

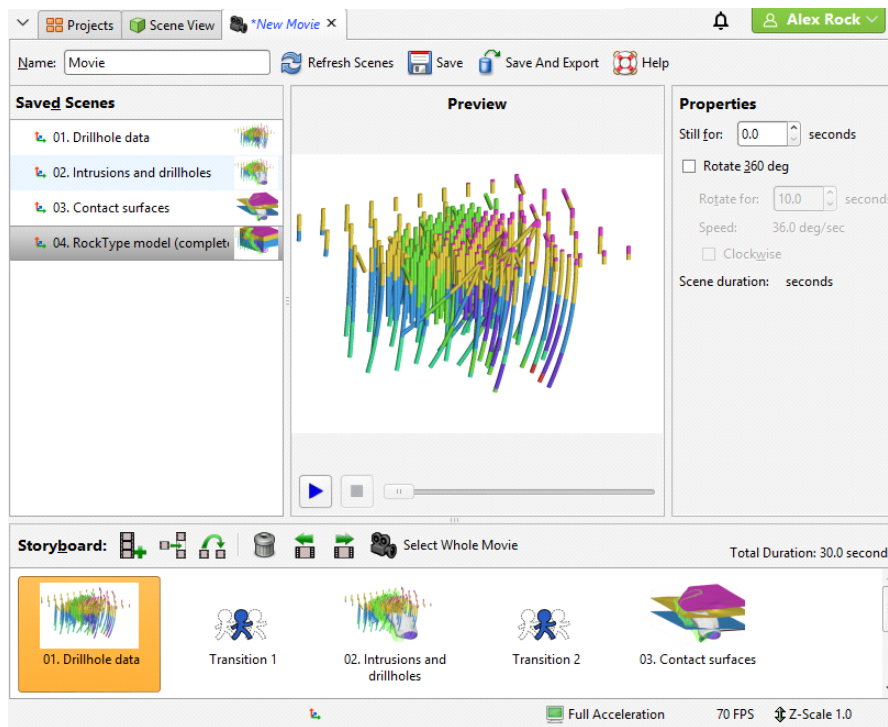

Change properties for the selected scene or transition, then click the play button (▶) to preview the settings. To preview the whole movie, click the **Select Whole Movie** button (🎬), then click play.

You can make changes to the included scenes without having to close and reopen the movie window. Simply update the scenes, then, in the movie editor, click the **Refresh Scenes** button.

Enter a name and description for the movie and click the **Save** button (💾). The movie will be saved in the **Saved Scenes and Movies** folder.

To export the movie, click the **Save and Export** button (📁). The **Export Movie** window will appear:

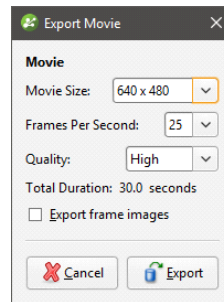

If you tick **Export frame images**, individual frames will be saved as images, together with the movie file. Click **Export**. You will be prompted to select a filename and location. Click **Save** to export the movie. Leapfrog Geothermal will then save the movie in the specified location, which may take some time.

Contour Lines

You can create contour lines from surfaces in the project and export those contour lines to GIS packages.

Creating Contour Lines

To create contour lines from a surface, right-click on the **Cross Sections and Contours** folder and select **New Contour Lines From Surface**. In the **New Contours** window, select the surface to contour from the list. Adjust the **Contour Spacing**, if required.

If you want to offset the contours by a vector, enter a **Contour offset** value.

Click **OK** to generate the contours.

The new contours will appear in the project tree under the **Cross Sections and Contours** folder.

You can edit the contours by double-clicking on them.

Exporting GIS Contours

To export a contour lines object, right-click on the contour lines in the **Cross Sections and Contours** folder and select **Export**. Select whether or not to export the contours in 2.5D format, then click **Export**. You will be prompted for a filename and location.